



**Lacor**

Brand of the Stars · Since 1949

# Catalogue 2018

Professional · Hotel · Restaurant







---

“Brand of the stars”





## *Liderazgo - Leadership - Leadership*

Somos una marca referencia dentro del sector de la hostelería y menaje doméstico. Tras años de esfuerzo nos hemos ganado una posición de liderazgo y nos hemos convertido en un referente en el sector.

Nous sommes une marque de référence dans le secteur de l'hôtellerie et des articles ménagers. Après de nombreuses années d'efforts, nous avons atteint une position de leadership et avons pu devenir une référence dans le secteur.

Lacor is a leading brand within the hospitality and catering and houseware sectors. After years of effort the company has earned a leadership position and has become a reference in the sector.

## *Tradición - Tradition - Tradition*

Pertenece a una tierra de profundas raíces gastronómicas, donde nuestros artesanos comenzaron a fabricar las primeras cazuelas hace 70 años. Hoy día mantenemos el mismo espíritu y pasión por nuestra propia historia.

Nous sommes issus d'une région aux profondes racines gastronomiques, où nos artisans ont commencé à fabriquer les premières casseroles il y a 70 ans. Nous conservons aujourd'hui le même état d'esprit et la même passion pour notre propre histoire.

Lacor comes from lands with deep gastronomic roots, where its artisans began to manufacture their first casseroles 70 years ago. The same spirit and passion of this long history is still maintained today

## *Calidad - Qualité - Quality*

Integramos la cultura de calidad tanto en nuestros procesos de fabricación y productos como en la relación con nuestros clientes y colaboradores, lo cual nos ha permitido ganarnos su confianza a lo largo del tiempo.

Nous intégrons la culture de la qualité aussi bien dans nos processus de fabrication et nos produits que dans la relation avec nos clients et collaborateurs, ce qui nous a permis de gagner leur confiance au fil du temps.

Lacor integrates a culture of quality into its manufacturing processes and products as well as in relationships with its customers and collaborators, which has enabled the company to earn their trust over time.

## *Empresa global - Entreprise globale - Global company*

Tenemos presencia en 90 países a lo largo de los 5 continentes. A través del esfuerzo de nuestros distribuidores hemos conseguido llegar a las cocinas profesionales y hogares de todo el mundo.

Nous sommes présents dans 90 pays répartis sur les 5 continents. À travers les efforts de nos distributeurs, nous avons pu pénétrer dans les cuisines professionnelles et les foyers du monde entier.

Lacor is present in 90 countries on the five continents. Through the efforts of its distributors the company has reached professional kitchens and homes around the world.

## *Equipo humano - L'équipe - Team*

Lacor está compuesto por un equipo cualificado de personas con un alto grado de compromiso hacia el servicio. Gracias a nuestra dedicación conseguimos establecer relaciones duraderas y de confianza con nuestra clientela.

Lacor est composé d'une équipe qualifiée de personnes hautement engagées envers le service. Grâce à notre dévouement, nous pouvons établir des relations durables et de confiance avec notre clientèle.

Lacor is made up of a qualified team of people with a high level of commitment towards service. Thanks to their dedication, the company establishes lasting relationships based on trust with its clientele.

# World

## AMERICA

Argentina  
Bolivia  
Brazil  
Canada  
Chile  
Colombia  
Costa Rica  
Cuba  
Dominican Rep.  
French Guayana  
Guadalupe  
Guatemala  
Honduras  
Jamaica  
Martinique  
Mexico  
Paraguay  
Peru  
United States  
Uruguay

## EUROPE

Andorra	Latvia
Austria	Lithuania
Belgium	Luxembourg
Bulgaria	Macedonia
Czech Republic	Montenegro
Croatia	Poland
Cyprus	Portugal
Denmark	Romania
Finland	Russia
France	Serbia
Germany	Slovenia
Greece	Spain
Holland	Sweden
Hungary	Switzerland
Iceland	Turkey
Ireland	UK+ N. Ireland
Italy	Ukraine





# Wide



## Condiciones generales de venta

- 1.- Los precios de la presente tarifa anulan los anteriores.
- 2.- En los precios están incluidos los conceptos de embalaje.
- 3.- Los portes serán PAGADOS a partir de los siguientes importes netos mínimos:
  - a.- Península y Baleares: 300 €
  - b.- Canarias, Ceuta y Melilla: 1.000 €
  - c.- Francia y Alemania: 775 €
  - d.- Reino Unido: 1.000 €
  - e.- Benelux, Italia e Irlanda: 1.200 €
  - f.- Para resto de países consultar
- 4.- El medio de transporte será a elección de esta Empresa.  
Cuando se desee el envío por un medio diferente al habitual de LACOR, los portes serán DEBIDOS.
- 5.- La forma de pago será mediante GIRO DOMICILIADO y el plazo máximo para el pago serán 60 días.  
Otras formas de pago deberán ser autorizadas por la dirección de la Empresa.
- 6.- Todas las devoluciones de mercancías tienen que ser autorizadas por la Empresa.  
Las devoluciones que no sean por problemas de calidad deberán llegar a portes pagados y se abonarán al 90% del valor de la mercancía.
- 7.- Las fotos, datos y medidas que aparecen en este catálogo son indicativos y susceptibles, sin previo aviso, de modificación por exigencias técnicas o de producción.

## Conditions générales de vente

- 1.- Les présents tarifs annulent les précédents.
- 2.- Dans les prix sont inclus les concepts d'emballage.
- 3.- Les ports seront PAYÉS à partir des montants nets suivants de facture minimums:
  - a.- Péninsule Ibérique et Baléares: 300 €
  - b.- Canaries, Ceuta et Melilla: 1.000 €
  - c.- France et Allemagne: 775 €
  - d.- Royaume Uni: 1.000 €
  - e.- Bénélux, Italie et Irlande: 1.200 €
  - f.- Pour le reste des pays, prière de le consulter
- 4.- Le moyen de transport sera au choix de cette entreprise.  
Si l'on désire l'envoi par un moyen différent à celui pratiqué habituellement par LACOR, les ports seront DUS.
- 5.- La forme de paiement sera par LETTRE DE CHANGE BANCAIRE et le délai de paiement maximum sera de 60 jours.  
D'autres formes de paiement devant être autorisées par la Direction de l'Entreprise.
- 6.- Tous les retours de marchandises doivent être autorisés par l'Entreprise.  
Les retours qui ne seront pas dus à des problèmes de qualité devront arriver avec les frais de ports payés et seront remboursés à 90% de la valeur de la marchandise.
- 7.- Les photos, données et mesures qui apparaissent dans ce catalogue sont à titre indicatif et sont susceptibles de modifications pour exigences techniques ou de production.

## Allgemeine geschäftsbedingungen

- 1.- Die Preise der vorliegenden Preisliste annullieren alle vorherigen.
- 2.- In den Preisen ist die Verpackung bereits enthalten.
- 3.- Die Transportkosten werden ab folgenden Mindestnettorechnungsbeträgen von uns ÜBERNOMMEN:
  - a.- Iberische Halbinsel und Balearen: 300 €
  - b.- Kanaren, Ceuta und Melilla: 1.000 €
  - c.- Frankreich und Deutschland: 775 €
  - d.- Vereinigtes Königreich: 1.000 €
  - e.- Benelux, Italien und Irland: 1.200 €
  - f.- Für andere Länder bitte anfragen
- 4.- Das Transportmittel liegt im Ermessen dieses Unternehmens. Wenn der Versand durch ein bestimmtes Transportmittel gewünscht wird, das nicht mit dem bei LACOR üblichen übereinstimmt, werden die Transportkosten IN RECHUNG GESTELLT.
- 5.- Die Zahlungsform erfolgt per EINZUGSVERFAHREN und das Zahlungsziel beträgt maximal 60 Tage.  
Andere Zahlungsform müssen vor den Geschäftsleitung des Unternehmens genehmigt werden.
- 6.- Alle Retouren von Ware müssen von der Geschäftsleitung bewilligt werden.  
Die Retouren, die nicht Qualitätsprobleme betreffen, müssen mit gezahlten Portokosten geschickt werden.  
Es werden 90% des Warenwerts zurückerstattet.
- 7.- Die in diesem Katalog enthaltenen Fotos, Informationen und Maße sind beschreibender Art und können aufgrund technischer oder produktionsbezogener Erfordernisse ohne vorherige Ankündigung geändert werden.

## General conditions of sale

- 1.- Current rate prices cancel prior rates.
- 2.- Packaging is included in the prices.
- 3.- Freight shall be PAID from the following minimum invoice amounts:
  - a.- Peninsula and Balearic: 300 €
  - b.- Canary Islands, Ceuta and Melilla: 1.000 €
  - c.- France and Germany: 775 €
  - d.- United Kingdom: 1.000 €
  - e.- Benelux, Italy and Ireland: 1.200 €
  - f.- For all other countries, please ask
- 4.- The transportation method shall be selected by this Company.  
When the delivery is requested through other means than the usual LACOR, freight be DUE.
- 5.- The payment method will be DIRECT PAYMENT and the payment terms will be a maximum of 60 days.  
Any other type of payment must be authorized by Company management.
- 6.- All merchandise returns must be authorized by the Company.  
Returns not made due to quality concerns must be delivered with freight paid and will be paid at 90% of the merchandise value.
- 7.- Photos, information and measurements that appear in this catalogue are for information and may be modified due to technical or production requirements at any time.

## Condições gerais de venda

- 1.- Os preços do presente tarifário anulam os anteriores.
- 2.- Nos preços estão incluídas as taxas de embalagem.
- 3.- Os portes serão PAGOS a partir dos seguintes valores líquidos mínimos:
  - a.- Península e Ilhas Baleares: 300 €
  - b.- Ilhas Canárias, Ceuta e Melilha: 1.000 €
  - c.- França e Alemanha: 775 €
  - d.- Reino Unido: 1.000 €
  - e.- Benelux, Itália e Irlanda: 1.200 €
  - f.- Para o resto dos países, consultar
- 4.- O meio de transporte será à escolha desta Empresa.  
Quando se desajar o envio por um meio diferente do habitual da LACOR, os portes serão BEVIDOS.
- 5.- A forma de pagamento será a de PAGAMENTO DOMICILIADO e o prazo máximo para o pagamento será 60 dias.  
Outras formas de pagamento deverão ser autorizadas pela Direção da Empresa.
- 6.- Todas as devoluções de mercadorias têm de ser autorizadas pela Empresa.  
As devoluções que não sejam devidas a problemas de qualidade deverão ser enviadas a portes pagos e serão pagas 90% do valor da mercadoria.
- 7.- As fotografias, dados e dimensões que constam deste catálogo são indicativos e suscetíveis, sem aviso prévio, de alteração por exigências técnicas ou de produção.

# Novedades Novelties

22

ECO-CHEF



28

Batería FOODIE  
FOODIE battery



50  
77

Wok TRIMETAL  
TRIMETAL wok



55  
85

Manoplas silicona GRIS  
GREY silicone mitten



56  
170

MAGMA



69  
70

FERRUM



68

Sartén DYNAMIC  
DYNAMIC frying-pan



82  
335

Tapete silicona  
Silicone covering



82  
335

Lámina antiadherente  
Non-stick sheets



119

Deshojador hierbas  
Herbs stripper



121  
325

Bot. biberón 3 puntas  
Botl. with 3 nozzles



140

Bandejas Pizarra  
Slate trays





159

Camino de mesa  
Table runner



172

Mini cubos  
Mini cubes



172

Cestillos Inox/bronce  
Inox/Bronze basket



188

Teteras  
Tea pot



198

Dosificador licor  
Jigger



198

Botella dosificador  
Coctail pourer



199

Sacacorchos BLACK  
BLACK corkscrew



201

Bomba vacío BLACK  
BLACK vacuum pump



214

Porta menús  
Menu cover

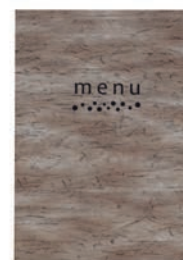

226

Cort. espiral manual  
Manual vegetables cutter



226

Cort. espiral spaguetis  
Spiral cutter



227

Cortador SAFECUT  
SAFECUT cutter



230

Ralladores Cerámicos  
Spices graters



232

Mandolina SMART  
SMART mandoline



247

Tablas de corte  
Cutting board



261  
380

Placas de inducción  
Induction cooker



261  
381

Placas de induc.DUAL  
DUAL induction cooker



263  
390

Lámp. calentamiento  
Heating lamps



266  
404

Tostadora ranura larga  
Long groove toaster



268  
399

AIRPOT



323

Boquillas Rusas  
Russian nozzles



326

Rejilla para repostería  
Pastry rack

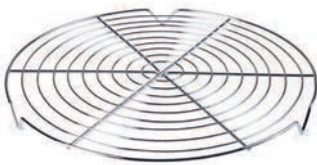

342

Moldes bombón  
Chocolate moulds



350

CookingMe



354

Yogurteras  
Yoghurt maker



359

Batidoras BRISK  
BRISK mixer



370

Cort. espiral eléctrico  
Electric vegetables cutter



371

Molinillo eléctrico  
Electric grinder



372

Deshidratador WHITE  
WHITE dehydrator



376

Freidora DAIRE  
DAIRE fryer



382

Placa Grill  
PROFESIONAL  
PROFESSIONAL grill plate



384

Plancha & Grill  
Grill plate



387

Gofrera  
Waffle maker



398

Espumador de leche  
Milk frother



411

Funda vaso blender  
Personal blender sleeve



412

Batidora Profesi. WHITE  
Professional blender



420

Máq. vacío EXTREME  
EXTREME vacumm machine



425

SOUS VIDE



426

Bolas para Sous Vide  
Balls for Sous vide



# Índice



## MENAJE / COOKWARE

Baterías Profesionales / Professional Cookware	16
Baterías Domésticas / Household Cookware	27
Ollas a presión / Pressure Cookers	60
Sartenes / Frypans	65
Rustideras - Horno / Roasting Pans - Oven	79
Paelleras / Paella Pans	86



## UTENSILIOS / UTENSILS

Juegos de Cocina / Kitchen Tools	92
Preparación / Food Processing	103
Básculas+Termómetros / Scales+Thermometers	127



## MESA / TABLE TOP

Bandejas / Trays	138
Melamina / Melamine	143
Servicio Mesa / Table Service	156
Pinzas / Tongs	178
Cafetería / Coffee	184
Termos / Thermos	189
Bar-Bodega / Wine Cellar	192
Portamenú / Portamenu	204



## CORTE / CUTTING

Corte / Cutting	222
-----------------	-----



# Index



## **BUFFET / BUFFET**

Chafing Dish + Buffet / Chafing Dish + Buffet

252



## **GASTRO / GASTRO**

Cubetas / Containers

272

Transporte - Estanterías / Transport - Shelves

280

Cestas / Raks

297

Almacenamiento-Limpieza / Storage Cleaning

302



## **REPOSTERIA / PASTRY**

Preparación - Repostería / Pastry Processing

308

Moldes - Aros / Mould - Cake Rings

328



## **ELÉCTRICO / ELECTRIC**

Eléctrico / Electric

350







MENAJE  
•  
COOKWARE

Baterías Profesionales  
*Professional Cookware*

•  
Baterías Domésticas  
*Household Cookware*

•  
Ollas a presión  
*Pressure Cookware*

•  
Sartenes  
*Frypans*

•  
Rustideras - Horno  
*Roasting Pans - Oven*

•  
Paelleras  
*Paella Pans*

## Chef-Luxe



**Toda la pieza (cuerpo, asas y mangos) fabricada en Acero Inoxidable 18/10**  
**Fondo Termomodificador (Inox 18/10 - Aluminio - Inox)**  
**Espesor 1,5 - 2 mm**  
**Tapas diseñadas para el ahorro energético**  
**Máxima garantía en cuanto a resistencia, durabilidad e higiene**  
**Apta para todos los tipos de cocina (incluida inducción y horno)**

Toute la pièce (corps, poignées et manches) est fabriquée en acier inoxydable 18/10  
 Fond thermo-diffuseur (Inox 18/10 - Aluminium - Inox)  
 Épaisseur 1,5 - 2 mm  
 Couvercles conçus pour une économie d'énergie  
 Garantie maximale en termes de résistance, de durabilité et d'hygiène  
 Compatible avec tous les types de cuisinières (y compris induction et four)

Ganzes Stück (Topf, Griffe und Stiele) aus rostfreiem Stahl 18/10  
 Wärmeleitender Boden (Edelstahl 18/10 - Aluminium - Edelstahl)  
 1,5 - 2 mm dick  
 Energieeffizient geformte Deckel  
 Garantiert robust, langlebig und hygienisch  
 Für alle Herdarten geeignet (inkl. Induktion und Ofen)

The whole product (body, handles and grips) is made in 18/10 stainless steel  
 Heat diffuser bottom (18/10 stainless steel - Aluminium - Stainless)  
 Thickness 1.5 - 2 mm  
 Covers designed for saving energy  
 Maximum guarantee in terms of resistance, durability and hygiene  
 Suitable for all types of cooking surfaces (including induction and the oven)

Peça fabricada inteiramente (corpo, asas e mangos) em aço inoxidável 18/10  
 Fundo termomodificador (Inox 18/10 - Alumínio - Inox)  
 Espessura 1,5 - 2 mm  
 Tampas concebidas para poupar energia  
 Máxima garantia de resistência, durabilidade e higiene  
 Apta para todos os tipos de fogões (incluindo placas de indução e forno)

### Cacerola con tapa

Faitout avec couvercle  
 Bratentopf mit Deckel  
 Casserole with lid  
 Caçarola com tampa

Ref	€	Ø (cm)	h (cm)	e (mm)	L	Pack
54020	65,50	20	10,0	1,5	2,90	1
54024	78,50	24	11,0	1,5	4,25	1
54028	89,10	28	11,0	1,5	6,70	1
54032	110,00	32	12,5	1,5	10,00	1
54036	134,20	36	14,0	1,5	14,20	1
54040	172,00	40	15,5	2,0	19,40	1
54045	212,60	45	17,0	2,0	27,00	1
* 54050	263,90	50	20,0	2,0	38,20	1

\* NO inducción · NOT induction

### Cacerola sin tapa

Faitout sans couvercle  
 Bratentopf ohne Deckel  
 Casserole without lid  
 Caçarola sem tampa

Ref	€	Pack
54020S	50,40	1
54024S	61,20	1
54028S	71,30	1
54032S	89,10	1
54036S	108,30	1
54040S	146,00	1
54045S	174,80	1
* 54050S	221,40	1

\* NO inducción · NOT induction



### Cacerola alta con tapa

Braisiere avec couvercle  
 Fleischtopf mit Deckel  
 Deep casserole with lid  
 Caçarola alta com tampa

Ref	€	Ø (cm)	h (cm)	e (mm)	L	Pack
54021	67,10	20	13,0	1,5	4,00	1
54025	82,50	24	14,0	1,5	6,70	1
54029	102,40	28	17,5	1,5	10,70	1
54033	117,20	32	18,0	1,5	14,60	1
54037	148,60	36	21,5	1,5	21,80	1
54041	194,80	40	24,5	2,0	30,00	1
54046	237,80	45	27,5	2,0	43,70	1
* 54051	307,20	50	30,0	2,0	58,80	1

\* NO inducción · NOT induction

### Cacerola alta sin tapa

Braisiere sans couvercle  
 Fleischtopf ohne Deckel  
 Deep casserole without lid  
 Caçarola alta sem tampa

Ref	€	Pack
54021S	53,40	1
54025S	67,80	1
54029S	83,60	1
54033S	96,70	1
54037S	124,80	1
54041S	168,60	1
54046S	201,30	1
* 54051S	270,00	1

\* NO inducción · NOT induction





**Olla con tapa**

Marmite traiteur avec couvercle  
Bratentopf mit Deckel  
Casserole with lid  
Çaçarola scom tampa

Ref	€	Ø (cm)	h (cm)	e (mm)	L	Pack
54120	73,80	20	20,0	1,5	6,20	1
54124	90,70	24	24,0	1,5	10,50	1
54128	108,30	28	28,0	1,5	17,20	1
54132	147,00	32	32,0	1,5	25,70	1
54136	184,70	36	36,0	1,5	36,50	1
54140	226,80	40	40,0	2,0	50,00	1
54145	290,80	45	45,0	2,0	71,50	1
* 54150	413,50	50	50,0	2,0	98,00	1

\* NO inducción · NOT induction

**Olla recta sin tapa**

Marmite traiteur s/couvercle  
Suppentopf ohne Deckel  
Stock Pot without lid  
Panela sem tampa

Ref	€	Pack
54120S	60,60	1
54124S	74,90	1
54128S	91,50	1
54132S	126,50	1
54136S	158,50	1
54140S	200,70	1
54145S	260,60	1
* 54150S	375,80	1

\* NO inducción · NOT induction



**Olla baja con tapa**

Marmite basse avec couvercle  
Gemüsetopf mit Deckel  
Low casserole with lid  
Çaçarola baixa com tampa

Ref	€	Ø (cm)	h (cm)	e (mm)	L	Pack
54119	70,20	20	15,0	1,5	4,70	1
54123	86,30	24	20,0	1,5	9,00	1
54127	107,00	28	22,0	1,5	13,50	1
54131	139,00	32	26,0	1,5	20,00	1
54135	158,50	36	29,0	1,5	29,50	1
* 54139	212,10	40	32,0	2,0	40,00	1

\* NO inducción · NOT induction

**Olla Baja sin tapa**

Marmite basse s/couvercle  
Gemüsetopf ohne Deckel  
Low stock pot without lid  
Panela baixa sem tampa

Ref	€	Pack
54119S	56,30	1
54123S	69,50	1
54127S	88,70	1
54131S	117,50	1
54135S	130,30	1
* 54139S	186,00	1

\* NO inducción · NOT induction



**Paellera con tapa**

Plat rond avec couvercle  
Pfanne mit Deckel  
Round dish with lid  
Paelheira com tampa

Ref	€	Ø (cm)	h (cm)	e (mm)	L	Pack
54636	135,00	36	7,0	1,5	7,00	1
54640	154,90	40	8,0	1,5	10,00	1
54645	183,20	45	8,5	2,0	12,00	1
* 54650	234,80	50	9,0	2,0	17,00	1

\* NO inducción · NOT induction

**Paellera sin tapa**

Plat rond s/couvercle  
Pfanne ohne Deckel  
Round dish without lid  
Paelheira sem tampa

Ref	€	Pack
54636S	103,80	1
54640S	128,70	1
54645S	149,40	1
* 54650S	191,00	1

\* NO inducción · NOT induction



**Cazo Recto**

Casserole  
Stielkasserolle, flach  
Saucepan  
Çaçarola direite



Ref	€	Ø (cm)	h (cm)	e (mm)	L	Pack
54212	33,70	12	7,0	1,2	0,75	1
54214	35,60	14	7,5	1,2	1,10	1
54216	37,50	16	8,0	1,5	1,60	1
54218	40,80	18	9,0	1,5	2,25	1
54220	46,20	20	10,0	1,5	2,90	1
54224	60,30	24	10,0	1,5	4,25	1
54228	69,60	28	11,0	1,5	6,70	1

**Cazo Recto Alto**

Casserole haute  
Stielkasserolle  
Deep saucepan  
Çaçarola alta direite



Ref	€	Ø (cm)	h (cm)	e (mm)	L	Pack
54217	39,30	16	11,0	1,5	2,20	1
54219	46,10	18	12,0	1,5	3,00	1
54221	48,60	20	13,0	1,5	4,00	1
54225	66,70	24	14,0	1,5	6,70	1
54229	80,00	28	17,5	1,5	10,70	1

**Cazo Francés**

Casserole Française  
Stielkasserolle, französisch  
French saucepan  
Francês caçarola direita



Ref	€	Ø (cm)	h (cm)	e (mm)	L	Pack
54225N	58,40	24	12,0	1,5	5,40	1
54229N	75,70	28	14,0	1,5	8,60	1

**Cazo cónico**

Sautase conique  
Sauteuse, Konisch  
Conical saute pan  
Caçarola cónica



Ref	€	Ø (cm)	h (cm)	e (mm)	L	Pack
55216	37,70	16	6,0	1,5	1,00	1
55220	41,40	20	6,5	1,5	1,60	1
55224	48,30	24	7,5	1,5	2,70	1

**Sautex**

Sauteuse  
Sauteuse  
Sauteuse  
Frigideira



Ref	€	Ø (cm)	h (cm)	e (mm)	L	Pack
* 54621	44,80	20	6,5	1,5	1,80	1
54625	53,90	24	6,5	1,5	2,70	1
54629	66,20	28	7,0	1,5	4,00	1
54633	83,00	32	8,5	1,5	4,70	1
54637	99,90	36	10,0	1,5	7,00	1

\* Ø20 NO asa - NOT handle

**Tapa**

Couvercle  
Deckel  
Lid  
Tampa



Ref	€	Ø (cm)	Pack
54916	12,20	16	1
54920	13,30	20	1
54924	15,20	24	1
54928	17,30	28	1
54932	21,30	32	1
54936	25,70	36	1
54940	29,00	40	1
54945	33,20	45	1
54950	39,50	50	1

## Chef-Classic



**Toda la pieza (cuerpo, asas y mangos) fabricada en Acero Inoxidable 18/10 Fondo Termodifusor (Inox 18/10 - Aluminio - Inox). Espesor 0,7 - 1,2 mm Tapas diseñadas para el ahorro energético Apta para todos los tipos de cocina (incluida inducción y horno) \* Excepto Ø60 Acabado mate interior y exterior Máxima garantía en cuanto a resistencia, durabilidad e higiene**

Toute la pièce (corps, poignées et manches) est fabriquée en acier inoxydable 18/10  
Fond thermo-diffuseur (Inox 18/10 - Aluminium - Inox)  
Épaisseur 0,7 - 1,2 mm. Couvercles conçus pour une économie d'énergie  
Compatible avec tous les types de cuisinières (y compris induction et four)  
\* Excepté Ø60  
Finition mate intérieur et extérieur  
Garantie maximale en termes de résistance, de durabilité et d'hygiène

Ganzes Stück (Topf, Griffe und Stiele) aus rostfreiem Stahl 18/10  
Wärmeleitender Boden (Edelstahl 18/10 - Aluminium - Edelstahl)  
0,7 - 1,2 mm dick. Energieeffizient geformte Deckel  
Für alle Herdarten geeignet (inkl. Induktion und Ofen) \* mit Ausnahme von Ø60  
Innen und außen satiniert  
Garantiert robust, langlebig und hygienisch

The whole product (body, handles and grips) is made in 18/10 stainless steel  
Heat diffuser bottom (18/10 stainless steel - Aluminium - Stainless)  
Thickness 0.7 - 1.2 mm. Covers designed for saving energy  
Suitable for all types of cooking surfaces (including induction and the oven)  
\* Except Ø60  
Interior and exterior matte finish  
Maximum guarantee in terms of resistance, durability and hygiene

Peça fabricada inteiramente (corpo, asas e mangos) em aço inoxidável 18/10  
Fundo Termodifusor (Inox 18/10 - Alumínio - Inox)  
Espessura 0,7 - 1,2 mm. Tampas concebidas para poupar energia  
Apta para todos os tipos de fogões (incluindo placas de indução e forno)  
\* Excepto Ø60  
Acabamento mate interior e exterior  
Máxima garantia de resistência, durabilidade e higiene

### Cacerola con tapa

Faitout avec couvercle  
Bratentopf mit Deckel  
Casserole with lid  
Caçarola com tampa



Ref	€	Ø (cm)	h (cm)	e (mm)	L	Pack
50016	40,30	16	8,0	0,7	1,60	1
50020	46,30	20	9,0	0,7	2,80	1
50024	53,30	24	9,5	0,8	4,25	1
50028	73,50	28	11,0	0,8	6,75	1
50032	89,80	32	12,5	0,8	10,00	1
50036	122,40	36	14,0	1,0	14,20	1
50040	143,30	40	15,5	1,0	19,40	1
50045	167,30	45	17,0	1,0	27,00	1
50050	232,20	50	20,0	1,0	38,20	1
* 50060	329,40	60	25,0	1,2	70,00	1

\* NO inducción - NOT induction

### Cacerola Alta con tapa

Braisiere avec couvercle  
Fleischtopf mit Deckel  
Deep casserole with lid  
Caçarola alta com tampa



Ref	€	Ø (cm)	h (cm)	e (mm)	L	Pack
50017	41,80	16	11,0	0,7	2,20	1
50021	49,90	20	13,0	0,7	4,00	1
50025	59,50	24	14,0	0,8	6,75	1
50029	76,30	28	17,5	0,8	10,00	1
50033	97,90	32	18,0	0,8	14,40	1
50037	133,80	36	21,5	1,0	21,80	1
50041	162,10	40	24,5	1,0	30,70	1
50046	187,10	45	27,5	1,0	43,70	1
50051	268,80	50	30,0	1,2	58,80	1
* 50061	376,40	60	35,0	1,2	98,00	1

\* NO inducción - NOT induction

### Cacerola Vapor

Panier vapeur  
Dampfkoch-Aussatz o/Untertopf  
Steam casserole  
Caçarola a vapor



Ref	€	Ø (cm)	h (cm)	e (mm)	Pack
50428	46,80	28	11,0	0,8	1
50432	51,20	32	12,5	0,8	1



**Olla Recta con tapa**

Marmite traiteur avec couvercle  
Suppentopf mit Deckel  
Stock pot with lid  
Panela com tampa

Ref	€	Ø (cm)	h (cm)	e (mm)	L	Pack
50116	44,70	16	16,0	0,8	3,20	1
50120	55,50	20	20,2	0,8	6,20	1
50124	70,80	24	24,0	0,8	10,50	1
50128	96,40	28	28,0	1,0	17,20	1
50132	134,80	32	32,0	1,0	25,70	1
50136	165,20	36	36,0	1,0	36,60	1
50140	199,10	40	40,0	1,2	50,00	1
50145	254,80	45	45,0	1,2	68,30	1
50150	399,90	50	50,0	1,2	98,00	1
* 50160	560,10	60	50,0	1,2	141,00	1

\* NO inducción • NOT induction



**Olla Baja con tapa**

Marmite basse a/couvercle  
Gemüsetopf mit Deckel  
Low stock pot with lid  
Panela baixa com tampa

Ref	€	Ø (cm)	h (cm)	e (mm)	L	Pack
50119	50,30	20	15,0	0,8	4,70	1
50123	67,20	24	20,0	0,8	9,00	1
50127	87,70	28	22,0	0,8	13,50	1
50131	127,80	32	26,0	1,0	20,80	1
50135	148,50	36	29,0	1,0	29,50	1
50139	187,20	40	32,0	1,2	40,00	1

**Cazo Recto**

Casserole  
Stielkasserolle, flach  
Saucepan  
Çaçarola direite



Ref	€	Ø (cm)	h (cm)	e (mm)	L	Pack
50212	21,90	12	7,0	0,7	0,75	1
50214	23,50	14	7,5	0,7	1,10	1
50216	25,80	16	8,0	0,8	1,60	1
50218	27,90	18	9,0	0,8	2,20	1
50220	30,90	20	9,0	0,8	2,80	1
50224	38,10	24	9,5	0,8	4,25	1
50228	53,50	28	11,0	0,8	6,75	1

**Cazo Recto Alto**

Casserole haute  
Stielkasserolle, hoch  
Deep saucepan  
Çaçarola alta direite



Ref	€	Ø (cm)	h (cm)	e (mm)	L	Pack
50217	27,60	16	11,0	0,8	2,10	1
50219	32,00	18	12,0	0,8	3,00	1
50221	36,10	20	13,0	0,8	4,00	1
50225	43,90	24	14,0	0,8	6,30	1
50229	59,80	28	17,5	0,8	10,20	1

**Cazo Francés**

Casserole Française  
Stielkasserolle, französisch  
French saucepan  
Francês çaçarola direite



Ref	€	Ø (cm)	h (cm)	e (mm)	L	Pack
50225N	42,20	24	12,0	0,8	5,50	1
50229N	54,30	28	14,0	0,8	8,50	1

**Cazo cónico**

Sautase conique  
Sautéuse, Konisch  
Conical saute pan  
Çaçarola cónica



Ref	€	Ø (cm)	h (cm)	e (mm)	L	Pack
51216	31,40	16	6,0	1,0	1,00	1
51218	33,10	18	6,0	1,0	1,20	1
51220	34,50	20	6,5	1,0	1,60	1
51222	37,60	22	7,0	1,0	2,10	1
51224	41,40	24	7,5	1,0	2,70	1

**Baño María con fondo**

Bahut avec fond  
Bain Marie Topf  
Double boiler with bottom  
Banho-Maria com fundo



Ref	€	Ø (cm)	h (cm)	e (mm)	L	Pack
50717	32,00	16	16,0	0,8	3,20	1
50721	41,60	20	20,0	0,8	6,20	1

**Paellera con tapa**

Plat rond a/couvercle  
Pfanne mit Deckel  
Round with lid  
Paelheira com tampa



Ref	€	Ø (cm)	h (cm)	e (mm)	L	Pack
50624	49,90	24	6,0	0,8	2,70	1
50628	68,00	28	6,0	0,8	3,60	1
50632	87,90	32	6,0	0,8	5,00	1
50636	111,20	36	7,0	1,0	7,10	1
50640	128,20	40	8,0	1,0	10,00	1
50645	150,60	45	8,5	1,0	13,50	1
50650	195,30	50	9,0	1,0	17,60	1
* 50660	282,30	60	9,0	1,0	25,40	1

\* NO inducción • NOT induction

**Sautex**

Sauteuse  
Sauteuse  
Sauteuse  
Frigideira



Ref	€	Ø (cm)	h (cm)	e (mm)	L	Pack
50625	36,60	24	6,5	0,8	2,70	1
50629	51,20	28	7,0	0,8	4,00	1
50633	57,90	32	8,5	0,8	4,70	1
50637	83,60	36	10,0	1,0	7,00	1

**Rustidera**

Plat à roir  
Bratpfanne  
Roaster  
Assadeira



Ref	€	cm	h (cm)	e (mm)	Pack
50540	92,50	40x30	8,0	1,0	1
50550	122,50	50x40	8,0	1,0	1
50560	154,20	60x45	8,0	1,0	1
50570	176,20	70x45	9,5	1,0	1

**Tapa**

Couvercle  
Deckel  
Lid  
Tampa



Ref	€	Ø (cm)	Pack
50916	8,30	16	1
50918	9,30	18	1
50920	10,80	20	1
50924	11,80	24	1
50928	13,50	28	1
50932	17,80	32	1
50936	21,40	36	1
50940	24,30	40	1
50945	29,00	45	1
50950	35,60	50	1
50960	46,40	60	1



## Eco-Chef

• **Nuevo diseño** •  
New design



Toda la pieza (cuerpo, asas y mangos) fabricada en Acero Inoxidable  
Fondo Termodifusor (Inox 18/10 - Aluminio - Inox). Espesor 0,6 - 1 mm  
Tapas diseñadas para el ahorro energético  
Apta para todos los tipos de cocina (incluida inducción y horno)  
Acabado interior mate y exterior brillo-mate  
Máxima garantía en cuanto a resistencia, durabilidad e higiene

Toute la pièce (corps, poignées et manches) est fabriquée en acier inoxydable  
Fond thermo-diffuseur (Inox 18/10 - Aluminium - Inox). Épaisseur 0,6 - 1 mm  
Couvercles conçus pour une économie d'énergie  
Compatible avec tous les types de cuisinières (y compris induction et four)  
Finition mate intérieur et brillant-mate extérieur  
Garantie maximale en termes de résistance, de durabilité et d'hygiène

Ganzes Stück (Topf, Griffe und Stiele) aus rostfreiem Stahl 18/10  
Wärmeleitender Boden (Edelstahl 18/10 - Aluminium - Edelstahl). 0,6 - 1 mm dick  
Energiesparende Deckel  
Für alle Herdarten geeignet (inkl. Induktion und Ofen)  
Innen satiniert und außen Helligkeit und satiniert  
Garantiert robust, langlebig und hygienisch

The whole product (body, handles and grips) is made in stainless steel  
Heat diffuser bottom (18/10 stainless steel - Aluminium - Stainless). Thickness 0.6 - 1 mm  
Covers designed for saving energy  
Suitable for all types of cooking surfaces (including induction and the oven)  
Interior matte finish and exterior brightness-matte finish  
Maximum guarantee in terms of resistance, durability and hygiene

Peça fabricada inteiramente (corpo, asas e mangos) em aço inoxidável  
Fundo Termodifusor (Inox 18/10 - Alumínio - Inox). Espessura 0,6 - 1 mm  
Tampas desenhadas para poupar energia  
Apta para todos os tipos de fogões (incluindo placas de indução e forno)  
Acabamento interior mate e exterior brilho-mate  
Máxima garantia de resistência, durabilidade e higiene



### Cacerola sin tapa

Faitout sans couvercle  
Bratentopf ohne Deckel  
Casserole without lid  
Caçarola sem tampa

Ref	€	Ø (cm)	h (cm)	e (mm)	L	Pack
57016	24,70	16	8,0	0,6	1,60	1
57020	30,20	20	9,0	0,6	2,80	1
57024	33,40	24	9,5	0,7	4,25	1
57028	52,90	28	11,0	0,7	6,75	1
57032	62,40	32	12,5	0,7	10,00	1
57036	89,70	36	14,5	0,7	14,20	1
57040	102,20	40	15,5	0,9	19,40	1



### Cacerola alta sin tapa

Braisiere sans couvercle  
Fleischtopf ohne Deckel  
Deep casserole without lid  
Caçarola alta sem tampa

Ref	€	Ø (cm)	h (cm)	e (mm)	L	Pack
57017	26,30	16	11,0	0,6	2,20	1
57021	31,90	20	13,0	0,6	4,00	1
57025	39,30	24	15,0	0,7	7,00	1
57029	56,80	28	17,5	0,7	10,00	1
57033	68,90	32	18,0	0,7	14,40	1
57037	98,80	36	21,5	0,9	21,80	1
57041	121,30	40	24,5	0,9	30,70	1



### Olla recta sin tapa

Marmite traiteur sans couvercle  
Suppentopf ohne Deckel  
Stock pot without lid  
Panela sem tampa

Ref	€	Ø (cm)	h (cm)	e (mm)	L	Pack
57116	30,00	16	16,0	0,7	3,20	1
57120	35,00	20	20,0	0,7	6,20	1
57124	49,40	24	24,0	0,7	10,50	1
57128	72,20	28	25,5	0,9	16,50	1
57132	101,80	32	32,0	0,9	25,70	1
57136	127,80	36	36,0	0,9	36,60	1
57140	157,30	40	40,0	1,0	50,00	1

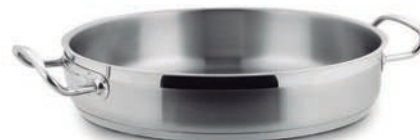

### Paellera sin tapa

Plat rond sans couvercle  
Pfanne ohne Deckel  
Round without lid  
Paelheira sem tampa

Ref	€	Ø (cm)	h (cm)	e (mm)	L	Pack
57624	32,50	24	6,5	0,7	3,00	1
57628	45,20	28	6,5	0,7	4,00	1
57632	57,60	32	7,0	0,7	5,00	1
57636	74,00	36	7,0	0,9	7,10	1
57640	85,30	40	8,0	0,9	10,00	1



**Cazo Recto**

Casserole  
Stielkasserolle, flach  
Saucepan  
Caçarola direita



Ref	€	Ø (cm)	h (cm)	e (mm)	L	Pack
57212	18,70	12	7,0	0,6	0,75	1
57214	20,00	14	7,5	0,6	1,10	1
57216	21,30	16	8,0	0,6	1,60	1
57218	23,40	18	8,5	0,6	2,00	1
57220	26,10	20	9,0	0,6	2,80	1
57224	33,60	24	9,5	0,7	4,25	1

**Cazo Recto Alto**

Casserole haute  
Stielkasserolle, hoch  
Deep saucepan  
Caçarola alta direita



Ref	€	Ø (cm)	h (cm)	e (mm)	L	Pack
57217	23,40	16	11,0	0,6	2,10	1
57219	27,20	18	12,0	0,6	3,00	1
57221	30,80	20	13,0	0,6	4,00	1
57225	42,40	24	15,0	0,7	6,50	1

**Baño María con fondo**

Bahut avec fond  
Bain Marie Topf  
Double boiler with bottom  
Banho-Maria com fundo



Ref	€	Ø (cm)	h (cm)	e (mm)	L	Pack
57717	27,40	16	16,0	0,7	3,20	1
57721	36,70	20	20,0	0,7	6,20	1

**Sautex**

Sauteuse  
Sauteuse  
Sauteuse  
Frigideira



Ref	€	Ø (cm)	h (cm)	e (mm)	L	Pack
57625	30,80	24	6,5	0,7	2,70	1
57629	46,70	28	7,0	0,7	4,00	1

**Tapa**

Couvercle  
Deckel  
Lid  
Tampa



Ref	€	Ø (cm)	Pack
57916	8,40	16	1
57920	10,60	20	1
57924	11,50	24	1
57928	13,30	28	1
57932	17,20	32	1
57936	21,10	36	1
57940	23,90	40	1

## Chef-Aluminio

*Aluminio puro (99,5%)  
Made in pure (99,5%) aluminium*



**Cuerpo fabricado en Aluminio puro (99,5%)**  
**Asas y mangos atérmicos en tubo de acero inoxidable 18/10**  
**Espesor 2,5 - 5 mm**  
**Tapas diseñadas para el ahorro energético**  
**Apta para todos los tipos de cocina (excepto inducción)**  
**Acabado mate interior y exterior mate lijado**  
**Máxima garantía en cuanto a resistencia, durabilidad e higiene**

Corps fabriqué en aluminium pur (99,5%)  
 Poignées et manches athermiques en tube d'acier inoxydable 18/10  
 Épaisseur 2,5 - 5 mm  
 Couvercles conçus pour une économie d'énergie  
 Compatible avec tous les types de cuisinières (excepté l'induction)  
 Finition intérieure mate et extérieure mate polie  
 Garantie maximale en termes de résistance, de durabilité et d'hygiène

Kessel aus reinem Aluminium (99,5%)  
 Griffe und Stiele aus hitzeabweisendem Edelstahlrohr 18/10  
 2,5 - 5 mm dick  
 Energiesparende Deckel  
 Für alle Herdarten geeignet (außer Induktion)  
 Innen und außen matt glänzend  
 Garantiert robust, langlebig und hygienisch

Body made in pure (99.5%) aluminium  
 Heatproof handles and grips in a 18/10 stainless steel tube  
 Thickness 2.5 - 5 mm  
 Covers designed for saving energy  
 Suitable for all types of cooking surfaces (except induction)  
 Interior matte finish and exterior sanded matte finish  
 Maximum guarantee in terms of resistance, durability and hygiene

Corpo fabricado em alumínio puro (99,5%)  
 Asas e mangos térmicos em tubo de aço inoxidável 18/10  
 Espessura 2,5 - 5 mm  
 Tampas desenhadas para poupar energia  
 Apta para todos os tipos de fogões (exceto placas de indução)  
 Acabamento mate interior e exterior mate lixado  
 Máxima garantia de resistência, durabilidade e higiene

### Cacerola con tapa

Braisiere a/couvercle  
 Fleischtopf mit Deckel  
 Deep casserole with lid  
 Caçarola alta com tampa



Ref	€	Ø (cm)	h (cm)	e (mm)	L	Pack
20020	37,30	20	8,0	2,5	2,50	1
20024	42,00	24	9,5	2,5	4,30	1
20026	45,40	26	10,5	2,5	5,55	1
20028	50,70	28	11,0	2,5	6,75	1
20030	54,60	30	11,5	2,5	8,15	1
20032	58,30	32	12,0	2,5	9,65	1
20034	63,50	34	13,0	3,0	11,80	1
20036	67,40	36	14,0	3,0	14,25	1
20038	75,30	38	15,0	3,0	17,00	1
20040	79,60	40	16,0	3,0	21,10	1
20045	95,00	45	18,0	3,5	28,00	1
20050	113,60	50	21,0	3,5	41,00	1
20055	146,00	55	23,0	4,5	54,00	1
20060	161,80	60	25,0	5,0	70,00	1

### Cacerola Alta c/ tapa

Braisiere a/couvercle  
 Fleischtopf mit Deckel  
 Deep casserole with lid  
 Caçarola alta com tampa



Ref	€	Ø (cm)	h (cm)	e (mm)	L	Pack
20021	41,00	20	13,0	2,5	4,10	1
20025	47,20	24	15,0	2,5	6,80	1
20027	49,80	26	16,0	2,5	8,50	1
20029	54,50	28	17,0	2,5	10,45	1
20031	59,40	30	18,0	2,5	12,70	1
20033	68,90	32	19,0	3,0	15,25	1
20035	74,30	34	21,0	3,0	18,05	1
20037	75,60	36	22,0	3,0	22,40	1
20039	82,50	38	23,0	3,0	26,10	1
20041	95,00	40	25,0	3,5	31,40	1
20046	108,50	45	28,0	3,5	45,00	1
20051	144,00	50	31,0	4,5	60,00	1
20056	165,00	55	34,0	4,5	80,00	1
20061	191,00	60	37,0	4,5	104,00	1

**Olla Recta con tapa**

Marmite traiteur a/couvercle  
Suppentopf mit Deckel  
Stock pot with lid  
Panela com tampa



Ref	€	Ø (cm)	h (cm)	e (mm)	L	Pack
20120	46,20	20	20,0	2,5	6,30	1
20124	53,80	24	24,0	2,5	10,85	1
20126	56,60	26	26,0	2,5	13,80	1
20128	68,30	28	28,0	3,0	17,25	1
20130	73,90	30	30,0	3,0	21,20	1
20132	81,50	32	32,0	3,0	25,75	1
20134	91,00	34	34,0	3,5	30,90	1
20136	97,80	36	36,0	3,5	36,65	1
20138	103,60	38	38,0	3,5	43,10	1
20140	117,90	40	40,0	4,0	50,30	1
20145	145,50	45	45,0	4,5	72,00	1
20150	163,80	50	50,0	4,5	100,00	1
20155	193,80	55	55,0	4,5	130,00	1
20160	238,90	60	55,0	5,0	155,50	1

**Paellera**

Plat rond  
Pfanne  
Round  
Paelheira



Ref	€	Ø (cm)	h (cm)	e (mm)	L	Pack
20628	32,50	28	7,0	2,5	4,30	1
20630	34,60	30	6,5	2,5	4,75	1
20632	36,90	32	7,0	2,5	5,50	1
20634	39,10	34	7,0	2,5	6,35	1
20636	41,40	36	7,5	2,5	7,45	1
20638	42,00	38	7,5	2,5	8,60	1
20640	49,40	40	8,0	3,0	10,05	1
20645	54,00	45	8,0	3,0	12,50	1
20650	62,90	50	8,0	3,5	15,50	1
20655	75,40	55	9,0	3,5	21,00	1
20660	89,90	60	10,0	4,5	28,00	1

**Cazo Recto**

Casserole  
Stielkasserolle, flach  
Saucepan  
Çaçarola direita



Ref	€	Ø (cm)	h (cm)	e (mm)	L	Pack
20216	21,00	16	7,0	2,5	1,40	1
20218	22,60	18	7,5	2,5	1,90	1
20220	24,80	20	8,0	2,5	2,50	1
20222	27,00	22	8,5	2,5	3,25	1
20224	28,60	24	9,5	2,5	4,30	1
20226	31,00	26	10,5	2,5	5,60	1
20228	33,30	28	11,0	2,5	6,80	1

**Cazo Recto Alto**

Casserole haute  
Stielkasserolle, hoch  
Deep saucepan  
Çaçarola alta direita



Ref	€	Ø (cm)	h (cm)	e (mm)	L	Pack
20217	24,80	16	11,0	2,5	2,20	1
20219	26,50	18	12,0	2,5	3,05	1
20221	28,50	20	13,0	2,5	4,10	1
20223	31,90	22	14,0	2,5	5,30	1
20225	33,10	24	15,0	2,5	6,80	1
20227	35,70	26	16,0	2,5	8,50	1
20229	38,30	28	17,0	2,5	10,50	1

**Cazo Bombado**

Casserole bombée  
Kasserolle, Bauchig  
Rounded saucepan  
Çaçarola bojuda



Ref	€	Ø (cm)	h (cm)	e (mm)	L	Pack
21216	21,00	16	8,0	2,5	1,50	1
21218	23,50	18	9,0	2,5	2,30	1
21220	25,20	20	10,0	2,5	2,50	1
21222	27,60	22	11,0	2,5	3,00	1
21224	30,10	24	12,0	2,5	4,00	1
21226	32,40	26	13,0	2,5	5,30	1
21228	35,70	28	14,0	2,5	6,50	1

**Pote cilindrico**

Pot-cilindrique  
Milchtopf  
Cylindrical pot  
Caneca cilíndrica



Ref	€	Ø (cm)	h (cm)	e (mm)	L	Pack
20716	26,20	16	16,0	2,5	3,20	1
20718	28,40	18	18,0	2,5	4,60	1
20720	31,30	20	20,0	2,5	6,30	1

**Rustidera con asa abatible**

Plat à rotir anse tombante  
Bratpfanne mit Fallgriffen  
Roaster moving handle  
Assadeira com asa abatível



Ref	€	cm	h (cm)	e (mm)	L	Pack
20540A	42,00	40x30	6,2	2,5	7,45	1
20545A	45,00	45x32	6,2	2,5	10,40	1
20550A	56,40	50x35	7,0	3,0	12,60	1
20555A	61,40	55x37	7,7	3,0	16,30	1
20560A	66,00	60x40	7,7	3,0	18,95	1
20565A	73,80	65x43	7,9	3,0	24,30	1
20570A	78,00	70x45	9,0	3,0	28,65	1

**Rustidera con asa fija**

Plat à rotir anse fixe  
Bratpfanne  
Roaster fix handle  
Assadeira com asa fixa



Ref	€	cm	h (cm)	e (mm)	L	Pack
20540F	42,00	40x30	6,2	2,5	7,45	1
20545F	45,00	45x32	6,2	2,5	10,40	1
20550F	56,40	50x35	7,0	3,0	12,60	1
20555F	61,40	55x37	7,7	3,0	16,30	1
20560F	66,00	60x40	7,7	3,0	18,95	1
20565F	73,80	65x43	7,9	3,0	24,30	1
20570F	78,00	70x45	9,0	3,0	28,65	1

**Bandeja horno**

Plaque à four  
Blackblech  
Deep oven tray  
Bandeja forno



Ref	€	cm	h (cm)	e (mm)	Pack
20551	31,40	50x35	2,0	2,5	1
20561	38,40	60x40	2,0	2,5	1

**Hervidor de pescado**

Poissonnière avec grille  
Fischkessel  
Fish kettle with grill and lid  
Peixeira



Ref	€	cm	h (cm)	e (mm)	L	Pack
20470	164,90	70x22	20,80	2,5	14,0	1

**Tapa**

Couvercle  
Deckel  
Lid  
Tampa



Ref	€	Ø (cm)	Pack
20920	11,20	20	1
20924	12,00	24	1
20926	12,50	26	1
20928	14,60	28	1
20930	15,30	30	1
20932	16,80	32	1
20934	17,20	34	1
20936	18,50	36	1
20938	19,30	38	1
20940	21,60	40	1
20945	23,30	45	1
20950	27,90	50	1
20955	30,40	55	1
20960	32,80	60	1



**Colador 4 sectores c/cacerola y tapa**

Cuit-pâtes 4 compartiments complet  
Teigwarenkochtopf mit 4 Einsätzen und Deckel  
4 segmented colander with casserole and lid  
Coader 4 sectores com caçarola e tampa

Ref	€	Ø (cm)	h (cm)	e (mm)	Pack
20337	376,20	36	17,5	2,5	1
20341	453,10	40	19,5	2,5	1



Baterías Domésticas  
Household Cookware

#CocinaConLacor





**New**

**Foodie**



**Asas y mangos ergonómicos de acero inoxidable fundido**  
**Máxima garantía en cuanto a resistencia, durabilidad e higiene**  
**Acabado interior y exterior lijado satinado**  
**Marcaje de capacidades en el interior (Litros)**  
**Fondo termodifusor sandwich (Inox 18/10 - Aluminio - Inoxidable)**  
**Distribución rápida y uniforme del calor**  
**Aptas para todos los fuegos (incluido inducción y horno)**  
**Aptas para el lavavajillas**

Poignées et manches ergonomiques en acier inoxydable fondu  
 Garantie maximale en termes de résistance, de durabilité et d'hygiène  
 Finition intérieure et extérieure en polissage satiné  
 Marquage des contenances à l'intérieur (Litres)  
 Fond thermodiffuseur sandwich (Inox 18/10 - Aluminium - Inoxydable)  
 Distribution rapide et uniforme de la chaleur  
 Aptes pour tous les types de feux (y compris l'induction et le four)  
 Aptes pour le lave-vaisselle

Ergonomische Griffe und Stiele aus gegossenem Edelstahl  
 Garantiert robust, langlebig und hygienisch  
 Außen- und Innenseite in mattem Schliff  
 Füllstandsanzeige (in Liter) auf der Innenseite  
 Wärmeleitender Sandwichboden (Edelstahl 18/10 - Aluminium - Edelstahl)  
 Gleichmäßige und schnelle Wärmeverteilung  
 Für alle Herdarten geeignet (inkl. Induktion und Ofen)  
 Waschmaschinen tauglich

Ergonomic handles and grips made of cast stainless steel  
 Maximum guarantee in terms of resistance, durability and hygiene  
 Glossy sanded interior and exterior finish  
 Capacity markings on the inside (Litres)  
 Heat-diffusing sandwiched base (18/10 Stainless Steel - Aluminium - St. Steel)  
 Quick and even heat distribution  
 Suitable for all types of cookers (including induction hobs and ovens)  
 Dishwasher safe

Asas e cabos ergonómicos em aço inoxidável fundido  
 Máxima garantia de resistência, durabilidade e higiene  
 Acabamento interior e exterior lijado acetinado  
 Indicação de capacidades no interior (em litros)  
 Fundo termodifusor tipo sanduíche (Inox 18/10 - Alumínio - Inoxidável)  
 Distribuição rápida e uniforme do calor  
 Apta para todo o tipo de fogões (incluindo placas de indução e fornos)  
 Lavável na máquina de lavar louça



**Cacerola con tapa**  
 Faitout avec couvercle  
 Bratentopf mit Deckel  
 Casserole with lid  
 Caçarola com tampa



**Olla con tapa**  
 Marmite avec couvercle  
 Fleichtopf mit Deckel  
 Stock pot with lid  
 Panela com tampa

Ref	€	Ø (cm)	h (cm)	L	Pack
45016	36,70	16	7,5	1,50	1
45018	39,80	18	8,5	2,00	1
45020	43,40	20	9,5	3,00	1
45022	48,80	22	10,5	4,00	1
45024	53,90	24	11,5	5,00	1
45026	59,50	26	12,5	6,50	1
45028	64,40	28	12,5	7,50	1

Ref	€	Ø (cm)	h (cm)	L	Pack
45116	40,10	16	13,0	2,50	1
45118	42,90	18	14,0	3,50	1
45120	48,50	20	15,5	4,80	1
45122	52,30	22	15,5	5,50	1
45124	58,30	24	16,0	7,00	1
45126	63,60	26	16,0	8,00	1
45128	72,30	28	17,0	10,00	1





**Cazo recto**

Casserole  
Stielkasserolle, flach  
saucepan  
Caçarola direita

Ref	€	Ø (cm)	h (cm)	L	Pack
45214	25,90	14	7,5	1,00	1
45216	28,10	16	7,5	1,50	1
45218	31,20	18	8,5	2,00	1
45220	35,20	20	9,5	3,00	1



**Tartera con tapa**

Plat rond avec couvercle  
Pfanne mit Deckel  
Round dish with lid  
Tarteira com tampa

Ref	€	Ø (cm)	h (cm)	L	Pack
45624	49,90	24	6,5	2,80	1
45626	54,60	26	6,5	3,00	1
45628	58,50	28	6,5	4,00	1

**Tapa**

Couvercle  
Deckel  
Lid  
Tampa



Ref	€	Ø (cm)	Pack
45916	9,90	16	1
45918	10,40	18	1
45920	11,20	20	1
45922	12,00	22	1
45924	13,00	24	1
45926	14,00	26	1
45928	15,30	28	1

## Black & White



**Toda la pieza (cuerpo, asas y mangos) fabricada en Acero Inoxidable 18/10**  
**Asas y mangos ergonómicos para un mejor agarre**  
**Tapa de cristal: permite visualizar el proceso de cocción sin tener que retirarla.**  
**Fondo Termodifusor sándwich (Inox 18/10 - Aluminio - Inox)**  
**Sistema de ahorro energético: Distribución rápida y uniforme del calor**  
**Destaca por su novedoso diseño; su acabado exterior blanco o negro**  
**Apta para todo tipo de cocinas (incluido inducción y horno). Apta para el lavavajillas**

Toute la pièce (corps, poignées et manches) est fabriquée en acier inoxydable 18/10  
 Poignées et manches ergonomiques pour une meilleure prise en main  
 Couvercle en verre : permet de visualiser le processus de cuisson sans avoir à le retirer  
 Fond thermo-diffuseur sandwich (Inox 18/10 - Aluminium - Inox)  
 Système d'économies d'énergie : distribution rapide et uniforme de la chaleur  
 Se distingue par son style innovant ; sa finition extérieure blanche ou noire  
 Compatible avec tout type de cuisinières (y compris induction et four)  
 Apte pour le lave-vaisselle

Ganzes Stück (Topf, Griffe und Stiele) aus rostfreiem Stahl 18/10  
 Ergonomische Griffe und Stiele für besseren Halt  
 Glasdeckel: Kochvorgang im Blick, ohne Deckel abzuheben.  
 Wärmeleitender Sandwichboden (Edelstahl 18/10 - Aluminium - Edelstahl)  
 Energiesparsystem: Gleichmäßige und schnelle Wärmeverteilung  
 Punktet mit neuem Design und Außenseite in Schwarz oder Weiß  
 Für alle Herdarten geeignet (inkl. Induktion und Ofen)  
 Waschmaschinen tauglich

The whole product (body, handles and grips) is made in 18/10 stainless steel  
 Ergonomic handles for a better grip  
 Glass cover: allows you to see the cooking process without needing to remove it.  
 Heat diffuser sandwich (18/10 stainless steel - Aluminium - Stainless)  
 Energy saving system: Quickly and uniformly distributes heat  
 Stands out for its new design; its black or white exterior finish  
 Suitable for all types of cooking surfaces (including induction and the oven)  
 Dishwasher safe

Peça fabricada inteiramente (corpo, asas e mangos) em aço inoxidável 18/10  
 Asas e mangos ergonómicos para melhor sujeição  
 Tampa de vidro, que permite visualizar o processo de cocção sem destapar.  
 Fundo termodifusor tipo sanduíche (Inox 18/10 - Alumínio - Inox)  
 Sistema de poupança energética, para uma distribuição rápida e uniforme do calor  
 Design inovador, com acabamento exterior em branco ou em preto  
 Apta para todo o tipo de fogões (incluindo placas de indução e forno)  
 Apta para máquinas de lavar louça

### Batería 5 piezas

Batterie 5 pcs.  
 5-Tlg-Batterie  
 Battery 5 pcs.  
 Bateria 5 pcs.

Ref	€	Pack
43005	249,40	1



Cacerola Ø20-24 cm  
 Olla Ø20-24 cm  
 Cazo Ø16 cm

### Batería 5 piezas

Batterie 5 pcs.  
 5-Tlg-Batterie  
 Battery 5 pcs.  
 Bateria 5 pcs.

Ref	€	Pack
44005	249,40	1



Cacerola Ø20-24 cm  
 Olla Ø20-24 cm  
 Cazo Ø16 cm

**Cacerola con tapa**  
Faitout av/couvercle  
Bratentopf m/Deckel  
Casserole with lid  
Caçarola com tampa



Ref	€	Ø (cm)	h (cm)	L	Pack
43016	39,40	16	8,0	1,60	1
43020	46,30	20	9,0	2,80	1
43024	57,00	24	9,5	4,20	1
43028	72,90	28	11,0	6,70	1

**Cacerola con tapa**  
Faitout avec couvercle  
Bratentopf mit Deckel  
Casserole with lid  
Caçarola com tampa



Ref	€	Ø (cm)	h (cm)	L	Pack
44016	39,40	16	8,0	1,60	1
44020	46,30	20	9,0	2,80	1
44024	57,00	24	9,5	4,20	1
44028	72,90	28	11,0	6,70	1

**Olla con tapa**  
Marmite avec couvercle  
Fleischtopf mit Deckel  
Stock pot with lid  
Panela com tampa



Ref	€	Ø (cm)	h (cm)	L	Pack
43116	43,90	16	13,0	2,50	1
43120	51,20	20	13,5	4,20	1
43124	65,40	24	15,0	6,50	1
43128	82,30	28	17,0	10,20	1

**Olla con tapa**  
Marmite avec couvercle  
Fleischtopf mit Deckel  
Stock pot with lid  
Panela com tampa



Ref	€	Ø (cm)	h (cm)	L	Pack
44116	43,90	16	13,0	2,50	1
44120	51,20	20	13,5	4,20	1
44124	65,40	24	15,0	6,50	1
44128	82,30	28	17,0	10,20	1

**Cazo Recto**  
Casserole  
Stielkasserole, flach  
Saucepan  
Caçarola direita



Ref	€	Ø (cm)	h (cm)	L	Pack
43214	26,30	14	7,5	1,15	1
43216	29,50	16	8,0	1,50	1
43218	33,20	18	8,5	2,00	1
43220	36,00	20	8,5	3,60	1

**Cazo recto**  
Casserole  
Stielkasserole, flach  
Saucepan  
Caçarola direita



Ref	€	Ø (cm)	h (cm)	L	Pack
44214	26,30	14	7,5	1,15	1
44216	29,50	16	8,0	1,50	1
44218	33,20	18	8,5	2,00	1
44220	36,00	20	8,5	3,60	1

**Tartera con tapa**  
Plat rond avec couvercle  
Pfanne mit Deckel  
Round dish with lid  
Tarteira com tampa



Ref	€	Ø (cm)	h (cm)	L	Pack
43624	54,40	24	7,0	3,00	1
43628	66,60	28	8,0	4,70	1

**Tartera con tapa**  
Plat rond avec couvercle  
Pfanne mit Deckel  
Round dish with lid  
Tarteira com tampa



Ref	€	Ø (cm)	h (cm)	L	Pack
44624	54,40	24	7,0	3,00	1
44628	66,60	28	8,0	4,70	1

**Pote cilíndrico**  
Pot-cilindrique  
Milchtopf  
Cylindrical pot  
Canela cilíndrica



Ref	€	Ø (cm)	h (cm)	L	Pack
43714	29,80	14	12,5	1,90	1
43716	34,50	16	13,0	3,00	1

**Pote cilíndrico**  
Pot-cilindrique  
Milchtopf  
Cylindrical pot  
Canela cilíndrica



Ref	€	Ø (cm)	h (cm)	L	Pack
44714	29,80	14	12,5	1,90	1
44716	34,50	16	13,0	3,00	1

## Pofesional



**Toda la pieza (cuerpo, asas y mangos) fabricada en Acero Inoxidable 18/10**  
**Favorece una distribución rápida y homogénea del calor**  
**Acabado pulido brillante exterior y lijado mate interior**  
**Máxima garantía en cuanto a resistencia, durabilidad e higiene**  
**Apta para todo tipo de cocinas (incluido inducción y horno)**  
**Fondo Termodifusor sándwich (Inox 18/10 - Aluminio - Inox)**  
**Apta para el lavavajillas**

Toute la pièce (corps, poignées et manches) est fabriquée en acier inoxydable 18/10  
 Favorise une distribution rapide et homogène de la chaleur  
 Finition extérieure polie brillante et intérieur polie mate  
 Garantie maximale en termes de résistance, de durabilité et d'hygiène  
 Compatible avec tout type de cuisinières (y compris induction et four)  
 Fond thermo-diffuseur sandwich (Inox 18/10 - Aluminium - Inox)  
 Apte pour le lave-vaisselle

Ganzes Stück (Topf, Griffe und Stiele) aus rostfreiem Stahl 18/10  
 Fördert eine gleichmäßige und schnelle Wärmeverteilung  
 Hochglanzpolierte Außen- und glänzend matte Innenseite  
 Garantiert robust, langlebig und hygienisch  
 Für alle Herdarten geeignet (inkl. Induktion und Ofen)  
 Wärmeleitender Sandwichboden (Edelstahl 18/10 - Aluminium - Edelstahl)  
 Waschmaschinen tauglich

The whole product (body, handles and grips) is made in 18/10 stainless steel  
 It favours quick and homogeneous heat distribution  
 Exterior glossy, polished finish and sanded matte interior.  
 Maximum guarantee in terms of resistance, durability and hygiene  
 Suitable for all types of cooking surfaces (including induction and the oven)  
 Sandwich heat diffuser (18/10 stainless steel - Aluminium - Stainless steel)  
 Dishwasher safe

Peça fabricada inteiramente (corpo, asas e mangos) em aço inoxidável 18/10  
 Favorece a distribuição rápida e homogénea do calor  
 Acabamento exterior brilhante polido, e interior mate lixado  
 Máxima garantia de resistência, durabilidade e higiene  
 Apta para todo o tipo de fogões (incluindo placas de indução e forno)  
 Fundo termodifusor tipo sanduiche (Inox 18/10 - Alumínio - Inox)  
 Apta para máquinas de lavar louça



### Bateria 8 piezas

Batterie 8 pcs.  
 8-Tlg-Batterie  
 Battery 8 pcs.  
 Bateria 8 pcs.

Ref	€	Pack
72000	314,70	1

Cacerola Ø16-20-24 cm  
 Olla Ø16-20 cm  
 Cazo Ø14-16 cm  
 Pote Ø14 cm

### Cacerola con tapa

Faitout a/couvercle  
 Bratentopf m/Deckel  
 Casserole with lid  
 Caçarola com tampa



Ref	€	Ø (cm)	h (cm)	L	Pack
72016	40,80	16	8,0	1,50	1
72020	47,60	20	8,5	2,50	1
72024	56,70	24	9,5	3,50	1
72028	72,20	28	11,0	6,50	1
72032	98,40	32	12,5	9,00	1

### Cazo Recto

Casserole  
 Stielkasserole, flach  
 Saucepan  
 Caçarola direita



Ref	€	Ø (cm)	h (cm)	L	Pack
72214	22,30	14	7,5	1,00	1
72216	25,10	16	8,0	1,50	1
72218	27,00	18	8,5	2,00	1
72220	30,30	20	8,5	2,50	1



**Olla con tapa**

Marmite a/couvercle  
Fleischtopf m/Deckel  
Stock pot with Lid  
Panela com tampa



Ref	€	Ø (cm)	h (cm)	L	Pack
72116	44,60	16	13,0	2,50	1
72120	51,50	20	14,5	4,50	1
72124	62,00	24	15,0	6,50	1
72128	80,90	28	17,0	10,00	1
72132	103,30	32	17,5	13,50	1

**Olla super alta con tapa**

Marmite S. Haute a/couvercle  
Hoher Fleischtopf mit Deckel  
Deep Stock pot with Lid  
Panela super alta com tampa



Ref	€	Ø (cm)	h (cm)	L	Pack
72125	68,00	24	20,0	9,00	1
72129	89,00	28	22,0	13,50	1

**Colador esférico**

Passoire à queue  
Seiher, mit Stiel  
Strainer  
Coador esférico



Ref	€	Ø (cm)	h (cm)	Pack
72318	26,60	18	8,5	1

**Escurridera**

Passoire sur pied  
Abtropfschüssel  
Colander with stand  
Escorredor



Ref	€	Ø (cm)	h (cm)	Pack
72324	40,50	24	11,0	1

**Cacerola vapor**

Panier vapeur  
Dampfkoch-Aufsatz  
Steam casserole  
Caçarola a vapor



Ref	€	Ø (cm)	h (cm)	L	Pack
72420	34,30	20	8,5	2,50	1
72424	41,60	24	9,5	3,50	1
72428	45,60	28	11,0	6,50	1

**Cuecepastas sin tapa**

Cuit-pâte sans couvercle  
Nudelkoch-Einsatz ohne Deckel  
Pasta cooker without lid  
Coze-massas sem tampa



Ref	€	Ø (cm)	h (cm)	L	Pack
72423	55,70	24	17,5	9,50	1

**Tartera con tapa**

Plat rond avec couvercle  
Pfanne m/Deckel  
Round dish with lid  
Tarteira com tampa



Ref	€	Ø (cm)	h (cm)	L	Pack
72620	46,50	20	6,5	2,00	1
72624	55,20	24	7,0	3,00	1
72628	69,80	28	8,0	4,50	1
72632	92,10	32	8,0	6,00	1

**Sautex**

Sauteuse  
Sauteuse  
Sauteuse  
Frigideira



Ref	€	Ø (cm)	h (cm)	L	Pack
72625	40,80	24	7,0	3,00	1
72629	51,00	28	8,0	4,50	1

**Pote cilíndrico**

Pot-cilindrique  
Milchtopf  
Cylindrical pot  
Caneca cilíndrica



Ref	€	Ø (cm)	h (cm)	L	Pack
72714	26,00	14	12,5	1,50	1
72716	29,60	16	13,0	2,50	1
72720	33,50	20	14,5	4,50	1

**Tapa**

Couvercle  
Deckel  
Lid  
Tampa



Ref	€	Ø (cm)	Pack
72916	10,80	16	1
72918	11,50	18	1
72920	13,60	20	1
72924	15,80	24	1
72928	20,50	28	1
72932	22,20	32	1



## Belly



**Toda la pieza (cuerpo, asas y mangos) fabricada en Acero Inoxidable 18/10**  
**El diseño de los cuerpos bombeados proporciona mayor capacidad**  
**Acabado interior pulido y exterior doble; lijado y pulido**  
**Ideal para cocinar de forma saludable y ahorrar energía**  
**Apta para todo tipo de cocinas (incluido inducción y horno)**  
**Apta para el lavavajillas**

Toute la pièce (corps, poignées et manches) est fabriquée en acier inoxydable 18/10  
 La forme bombée des corps confère une plus grande capacité  
 Finition intérieur polie et extérieur double; limage et polissage  
 Idéal pour cuisiner sainement et réaliser des économies d'énergie  
 Compatible avec tout type de cuisinières (y compris induction et four)  
 Apte pour le lave-vaisselle

Ganzes Stück (Topf, Griffe und Stiele) aus rostfreiem Stahl 18/10  
 Konvex geformter Kessel mit höherem Fassungsvermögen  
 Polierte Innen- und hochglanzpolierte Außenseite  
 Ideal für gesundheitsbewusste und energiesparende Küche  
 Für alle Herdarten geeignet (inkl. Induktion und Ofen)  
 Waschmaschinen tauglich

The whole product (body, handles and grips) is made in 18/10 stainless steel  
 Its rounded body provides greater capacity  
 A polished interior finish and double coated, sanded and polished exterior.  
 Ideal for cooking healthy while saving energy  
 Suitable for all types of cooking surfaces (including induction and the oven)  
 Dishwasher safe

Peça fabricada integralmente (corpo, asas e mangos) em aço inoxidável 18/10  
 O design côncavo proporciona maior capacidade  
 Acabamento interior polido, e exterior lixado e polido  
 Ideal para cozinhar de forma saudável e poupar energia  
 Apta para todo o tipo de fogões (incluindo placas de indução e forno)  
 Apta para máquinas de lavar louça



### Batería 8 piezas

Batterie 8 pcs.  
 8-Tlg-Batterie  
 Battery 8 pcs.  
 Bateria 8 pcs.

Ref	€	Pack
79000	337,90	1

Cacerola Ø16-20 cm  
 Olla Ø16-20 cm  
 Cazo Ø14-16 cm  
 Pote Ø14 cm

### Lote 4 cazos

Ensemble 4 casseroles  
 Set 4 Tlg. Stielkasserollen  
 Set 4 saucepans  
 Lote de 4 caçarola

Ref	€	Pack
79003	111,70	1



Cazo Ø14 cm  
 Ø16 cm  
 Ø18 cm  
 Ø20 cm



**Cacerola con tapa**  
Faitout avec couvercle  
Bratentopf mit Deckel  
Casserole with lid  
Caçarola com tampa

Ref	€	Ø (cm)	h (cm)	L	Pack
79016	37,20	16	8,0	1,80	1
79020	50,50	20	10,0	3,50	1
79024	68,80	24	14,0	6,00	1
79028	90,40	28	14,5	9,50	1



**Olla con tapa**  
Marmite avec couvercle  
Fleischtopf mit Deckel  
Stock pot with Lid  
Panela com tampa

Ref	€	Ø (cm)	h (cm)	L	Pack
79116	41,60	16	11,5	2,20	1
79120	57,10	20	13,0	4,00	1
79124	73,30	24	15,0	7,00	1
79128	97,00	28	16,0	11,00	1



**Cazo Recto**  
Casserole  
Stielkasserole, flach  
Saucepan  
Caçarola direite

Ref	€	Ø (cm)	h (cm)	L	Pack
79214	26,10	14	7,5	1,20	1
79216	30,40	16	8,0	1,80	1
79218	34,50	18	9,0	2,50	1
79220	39,90	20	10,0	3,50	1



**Cacerola vapor**  
Panier vapeur  
Dampfkoch-Aufsatz  
Steam casserole  
Caçarola a vapor

Ref	€	Ø (cm)	h (cm)	L	Pack
79420	32,40	20	9,5	3,00	1
79424	43,20	24	12,0	4,50	1



**Tartera con tapa**  
Plat rond avec couvercle  
Pfanne mit Deckel  
Round dish with lid  
Tarteira com tampa

Ref	€	Ø (cm)	h (cm)	L	Pack
79624	57,40	24	6,0	3,00	1
79628	72,80	28	7,0	4,80	1



**Pote**  
Pot  
Milchtopf  
Pot  
Caneca

Ref	€	Ø (cm)	h (cm)	L	Pack
79714	26,10	14	11,0	1,40	1



**Wok**  
Wok  
Wok  
Wok  
Wok

Ref	€	Ø (cm)	h (cm)	L	Pack
79830	58,50	30	11,0	5,00	1



**Tapa**  
Couvercle  
Deckel  
Lid  
Tampa

Ref	€	Ø (cm)	Pack
79916	11,90	16	1
79920	15,90	20	1
79924	19,70	24	1
79928	24,90	28	1

## Vitrocor



**Toda la pieza (Cuerpo, asas y mangos) fabricada en Acero Inoxidable 18/10**  
**Favorece una distribución rápida y homogénea del calor**  
**Destaca por su diseño clásico, funcionalidad y sencillez práctica**  
**Acabado pulido brillante exterior y lijado mate interior**  
**Apta para todo tipo de cocinas (incluido inducción y horno)**  
**Fondo Termodifusor sándwich (Inox 18/10 - Aluminio - Inox)**  
**Apta para el lavavajillas**

Toute la pièce (corps, poignées et manches) est fabriquée en acier inoxydable 18/10  
 Favorise une distribution rapide et homogène de la chaleur  
 Se distingue par son style classique, sa fonctionnalité et sa simplicité pratique  
 Finition extérieur polie brillante et intérieur limage mat  
 Compatible avec tout type de cuisinières (y compris induction et four)  
 Fond thermo-diffuseur sandwich (Inox 18/10 - Aluminium - Inox)  
 Apte pour le lave-vaisselle

Ganzes Stück (Topf, Griffe und Stiele) aus rostfreiem Stahl 18/10  
 Fördert gleichmäßige und schnelle Wärmeverteilung  
 Punktet mit klassischem Design, Funktionalität und einfacher Handhabung  
 Hochglanzpolierte Außen- und glänzend matte Innenseite  
 Für alle Herdarten geeignet (inkl. Induktion und Ofen)  
 Wärmeleitender Sandwichboden (Edelstahl 18/10 - Aluminium - Edelstahl)  
 Waschmaschinen tauglich

The whole product (body, handles and grips) is made in 18/10 stainless steel  
 It favours quick and homogeneous heat distribution  
 Stands out for its classic design, functionality and practical simplicity  
 Exterior glossy, polished finish and sanded matte interior.  
 Suitable for all types of cooking surfaces (including induction and the oven)  
 Sandwich heat diffuser (18/10 stainless steel - Aluminium - Stainless steel)  
 Dishwasher safe

Peça fabricada integralmente (corpo, asas e mangos) em aço inoxidável 18/10  
 Favorece a distribuição rápida e homogénea do calor  
 Design clássico, simples e funcional  
 Acabamento exterior polido brilhante, e mate lixado no interior  
 Apta para todo o tipo de fogões (incluindo placas de indução e forno)  
 Fundo termodifusor tipo sanduíche (Inox 18/10 - Alumínio - Inox)  
 Apta para máquinas de lavar louça

### Batería 8 piezas

Batterie 8 pcs.  
 8-Tlg-Batterie  
 Battery 8 pcs.  
 Bateria 8 pcs.

Ref	€	Pack
40000	259,90	1



Cacerola Ø16-20-24 cm  
 Olla Ø16-20 cm  
 Cazo Ø14-16 cm  
 Pote Ø14 cm

### Cacerola con tapa

Faitout avec couvercle  
 Bratentopf mit Deckel  
 Casserole with lid  
 Caçarola com tampa



Ref	€	Ø (cm)	h (cm)	L	Pack
40016	31,70	16	8,0	1,50	1
40018	34,60	18	8,5	2,00	1
40020	38,20	20	8,5	2,50	1
40022	42,00	22	9,0	3,00	1
40024	44,60	24	9,5	3,50	1
40026	50,90	26	9,5	4,50	1
40028	65,10	28	11,0	6,50	1
40032	82,10	32	12,5	9,50	1
40036	111,60	36	14,0	14,20	1
40040	129,60	40	15,5	19,50	1

### Olla con tapa

Marmite avec couvercle  
 Fleischtopf mit Deckel  
 Stock pot with Lid  
 Panela com tampa



Ref	€	Ø (cm)	h (cm)	L	Pack
40116	35,40	16	13,0	2,50	1
40118	37,70	18	14,0	3,50	1
40120	41,20	20	14,5	4,50	1
40122	45,70	22	14,5	5,50	1
40124	51,00	24	15,0	6,50	1
40126	55,90	26	15,0	7,50	1
40128	71,20	28	17,0	10,00	1
40132	86,00	32	17,5	13,50	1
40136	121,90	36	21,5	22,00	1
40140	148,50	40	24,5	30,80	1



**Olla super alta con tapa**

Marmite S. Haute a/couvercle  
Hoher Fleischtopf mit Deckel  
Deep Stock pot with Lid  
Panela super alta com tampa



Ref	€	Ø (cm)	h (cm)	L	Pack
40121	45,00	20	17,5	5,50	1
40125	58,70	24	20,0	9,00	1
40129	79,20	28	22,0	13,50	1
40133	117,40	32	28,0	22,50	1

**Cazo Recto**

Casserole  
Stielkasserole, flach  
Saucepan  
Çaçarola direite



Ref	€	Ø (cm)	h (cm)	L	Pack
40212	19,90	12	7,0	0,80	1
40214	20,70	14	7,5	1,00	1
40216	23,40	16	8,0	1,50	1
40218	25,40	18	8,5	2,00	1
40220	29,40	20	8,5	2,50	1

**Cacerola vapor**

Panier vapeur  
Dampfkoch-Aufsatz  
Steam casserole  
Çaçarola a vapor



Ref	€	Ø (cm)	h (cm)	L	Pack
40420	28,20	20	8,5	2,50	1
40424	35,70	24	9,5	3,50	1
40428	39,20	28	11,0	6,50	1

**Cuecepastas sin tapa**

Cuit-pâte sans couvercle  
Nudelkoch-Einsatz ohne Deckel  
Pasta cooker without lid  
Coze-massas sem tampa



Ref	€	Ø (cm)	h (cm)	L	Pack
40426	51,90	24	17,5	9,50	1

**Pote cilíndrico**

Pot-cilindrique  
Milchtopf  
Cylindrical pot  
Caneca cilíndrica



Ref	€	Ø (cm)	h (cm)	L	Pack
40712	23,40	12	12,0	1,00	1
40714	24,70	14	12,5	1,50	1
40716	27,30	16	13,0	2,50	1
40718	30,40	18	14,0	3,50	1

**Tartera con tapa**

Plat rond avec couvercle  
Pfanne mit Deckel  
Round dish with lid  
Tarteira com tampa



Ref	€	Ø (cm)	h (cm)	L	Pack
40620	37,70	20	6,5	2,00	1
40622	40,20	22	6,5	2,50	1
40624	44,20	24	7,0	3,00	1
40626	48,00	26	7,0	3,50	1
40628	60,00	28	8,0	4,50	1
40632	73,00	32	8,0	6,00	1
40636	96,70	36	8,5	7,50	1
40640	111,80	40	8,5	11,00	1

**Colador esférico**

Passoire à queue  
Seiher, mit Stiel  
Strainer  
Coador esférico



Ref	€	Ø (cm)	h (cm)	Pack
40318	25,20	18	8,5	1

**Tapa**

Couvercle  
Deckel  
Lid  
Tampa



Ref	€	Ø (cm)	Pack
40912	7,80	12	1
40914	8,40	14	1
40916	8,50	16	1
40918	8,60	18	1
40920	9,20	20	1
40922	9,70	22	1
40924	10,70	24	1
40926	11,50	26	1
40928	14,50	28	1
40932	18,10	32	1
40936	23,70	36	1
40940	27,00	40	1

**Escurridera**

Passoire sur pied  
Abtropfschüssel  
Colander with stand  
Escorredor



Ref	€	Ø (cm)	h (cm)	Pack
40324	39,70	24	11,0	1





## Gourmet



**Toda la pieza (cuerpo, asas y mangos) fabricada en Acero Inoxidable 18/10**  
**Favorece una distribución rápida y homogénea del calor**  
**Extremadamente robustos**  
**Acabado pulido brillante exterior y lijado mate interior**  
**Apta para todo tipo de cocinas (Incluido inducción y horno)**  
**Triple fondo difusor que asegura un eficiente reparto del calor**  
**Apta para el lavavajillas**

Toute la pièce (corps, poignées et manches) est fabriquée en acier inoxydable 18/10  
 Favorise une distribution rapide et homogène de la chaleur  
 Extrêmement robustes  
 Finition extérieur polie brillante et intérieur limage mat  
 Compatible avec tout type de cuisinières (y compris induction et four)  
 Triple fond diffuseur qui garantit une répartition efficace de la chaleur  
 Apte pour le lave-vaisselle

Ganzes Stück (Topf, Griffe und Stiele) aus rostfreiem Stahl 18/10  
 Fördert gleichmäßige und schnelle Wärmeverteilung  
 Sehr robust  
 Hochglanzpolierte Außen- und glänzend matte Innenseite  
 Für alle Herdarten geeignet (inkl. Induktion und Ofen)  
 Dreifachboden gewährleistet leistungsstarke Wärmeleitung  
 Waschmaschinen tauglich

The whole product (body, handles and grips) is made in 18/10 stainless steel  
 It favours quick and homogeneous heat distribution  
 Extremely robust  
 Exterior glossy, polished finish and sanded matte interior.  
 Suitable for all types of cooking surfaces (including induction and the oven)  
 Triple diffuser bottom assuring efficient distribution of heat  
 Dishwasher safe

Peça fabricada integralmente (corpo, asas e mangos) em aço inoxidável 18/10  
 Favorece a distribuição rápida e homogénea do calor  
 Extremamente robustas  
 Acabamento exterior polido brilhante, e mate lixado no interior  
 Aptas para todo o tipo de fogões (incluindo placas de indução e forno)  
 Fundo difusor triplo, para uma distribuição eficiente do calor  
 Apta para máquinas de lavar louça



### Batería 8 piezas

Batterie 8 pcs.  
 8-Tlg-Batterie  
 Battery 8 pcs.  
 Bateria 8 pcs.

Ref	€	Pack
90000	279,20	1

Cacerola Ø16-20-24 cm  
 Olla Ø16-20 cm  
 Cazo Ø14-16 cm  
 Pote Ø14 cm

### Cacerola con tapa

Faitout avec couvercle  
 Bratentopf mit Deckel  
 Casserole with lid  
 Caçarola com tampa



### Cazo Recto

Casserole  
 Stielkasserole, flach  
 Saucepan  
 Caçarola direita



Ref	€	Ø (cm)	h (cm)	L	Pack
90016	34,90	16	8,0	1,50	1
90018	37,70	18	8,5	2,00	1
90020	41,10	20	8,5	2,50	1
90022	44,70	22	9,0	3,00	1
90024	48,30	24	9,5	3,50	1
90026	54,10	26	9,5	4,50	1
90028	66,90	28	11,0	6,50	1
90032	83,20	32	12,5	9,50	1

Ref	€	Ø (cm)	h (cm)	L	Pack
90212	21,50	12	7,0	0,80	1
90214	22,60	14	7,5	1,00	1
90216	25,20	16	8,0	1,50	1
90218	27,20	18	8,5	2,00	1
90220	30,80	20	8,5	2,50	1



**Olla con tapa**

Marmite avec couvercle  
Fleischtopf mit Deckel  
Stock pot with Lid  
Panela com tampa

Ref	€	Ø (cm)	h (cm)	L	Pack
90116	38,10	16	13,0	2,50	1
90118	41,50	18	14,0	3,50	1
90120	43,90	20	14,5	4,50	1
90122	49,00	22	14,5	5,50	1
90124	54,30	24	15,0	6,50	1
90126	58,50	26	15,0	7,50	1
90128	73,10	28	17,0	10,00	1
90132	94,70	32	17,5	13,50	1



**Olla super alta con tapa**

Marmite S. Haute a/couvercle  
Hoher Fleischtopf mit Deckel  
Deep Stock pot with Lid  
Panela super alta com tampa

Ref	€	Ø (cm)	h (cm)	L	Pack
90125	62,70	24	20,0	9,00	1
90129	81,50	28	22,0	13,50	1



**Cacerola vapor**

Panier vapeur  
Dampfkoch-Aufsatz  
Steam casserole  
Caçarola a vapor

Ref	€	Ø (cm)	h (cm)	L	Pack
90420	32,00	20	8,5	2,50	1
90424	39,10	24	9,5	3,50	1



**Tartera con tapa**

Plat rond a/couvercle  
Pfanne mit Deckel  
Round dish with lid  
Tarteira com tampa

Ref	€	Ø (cm)	h (cm)	L	Pack
90620	41,10	20	6,5	2,00	1
90622	44,00	22	6,5	2,50	1
90624	47,10	24	7,0	3,00	1
90626	51,30	26	7,0	3,50	1
90628	61,00	28	8,0	4,50	1
90632	75,90	32	8,0	6,00	1



**Escurridera**

Passoire sur pied  
Abtropfschüssel  
Colander with stand  
Escorredor

Ref	€	Ø (cm)	h (cm)	Pack
90324	37,90	24	11,0	1



**Colador esférico**

Passoire à queue  
Seiher, mit Stiel  
Strainer  
Coador esférico

Ref	€	Ø (cm)	h (cm)	Pack
90318	25,20	18	8,5	1



**Pote cilíndrico**

Pot-cilindrique  
Milchtopf  
Cylindrical pot  
Caneça cilíndrica

Ref	€	Ø (cm)	h (cm)	L	Pack
90712	23,70	12	12,0	1,00	1
90714	25,00	14	12,5	1,50	1
90716	27,90	16	13,0	2,50	1
90718	30,50	18	14,0	3,50	1

**Tapa**

Couvercle  
Deckel  
Lid  
Tampa



Ref	€	Ø (cm)	Pack
90912	9,20	12	1
90914	9,30	14	1
90916	9,40	16	1
90918	9,40	18	1
90920	9,50	20	1
90922	9,60	22	1
90924	10,60	24	1
90926	11,50	26	1
90928	15,00	28	1
90932	19,40	32	1

## Basic



**Toda la pieza ( cuerpo, asas y mangos) fabricada en Acero Inoxidable**  
**La tapa, con cierre de precisión, preserva los aromas y retiene el calor**  
**Ideal para cocinar de forma saludable y ahorrar energía**  
**Acabado exterior lijado satinado e interior pulido brillante**  
**Apta para todo tipo de cocinas (incluido inducción y horno)**  
**Apta para el lavavajillas**

Toute la pièce (corps, poignées et manches) est fabriquée en acier inoxydable  
 Le couvercle, avec fermeture de précision, préserve les arômes et retient la chaleur  
 Idéal pour cuisiner sainement et réaliser des économies d'énergie  
 Finition extérieure limée satinée et intérieur polie brillante  
 Compatible avec tout type de cuisinières (y compris induction et four)  
 Apte pour le lave-vaisselle

Ganzes Stück (Topf, Griffe und Stiele) aus rostfreiem Stahl  
 Deckel mit Druckverschluss bewahrt Geschmack und Wärme  
 Ideal für gesundheitsbewusste und energiesparende Küche  
 Innenseite mit mattem Schliff und Außenseite hochglanzpoliert  
 Für alle Herdarten geeignet (inkl. Induktion und Ofen)  
 Waschmaschinen tauglich

The whole product (body, handles and grips) is made in stainless steel  
 The cover, with precision fit, retains the aromas and heat.  
 Ideal for cooking healthy while saving energy  
 A sanded, satin exterior finish and shiny, polished interior  
 Suitable for all types of cooking surfaces (including induction and the oven)  
 Dishwasher safe

Peça fabricada integralmente (corpo, asas e mangos) em aço inoxidável  
 Tampa com fecho de precisão, para preservar melhor os aromas e conservar o calor  
 Ideal para cozinhar de forma saudável e poupar energia  
 Acabamento exterior acetinado lixado, e brilhante polido no interior  
 Apta para todo o tipo de fogões (incluindo placas de indução e forno)  
 Apta para máquinas de lavar louça



### Bateria 8 piezas

Batterie 8 pcs.  
 8-Tlg-Batterie  
 Battery 8 pcs.  
 Bateria 8 pcs.

Ref	€	Pack
32000	211,60	1

Cacerola Ø16-20-24 cm  
 Olla Ø16-20 cm  
 Cazo Ø14-16 cm  
 Pote Ø14 cm

### Lote 4 cazos

Ensemble 4 casseroles  
 Set 4 Tlg. Stielkasserollen  
 Set 4 saucepans  
 Lote de 4 caçarola

Ref	€	Pack
32003	73,10	1

Cazo Ø14 cm  
 Ø16 cm  
 Ø18 cm  
 Ø20 cm



**Cacerola con tapa**

Faitout a/couvercle  
Bratentopf m/Deckel  
Casserole with lid  
Çaçarola com tampa



Ref	€	Ø (cm)	h (cm)	L	Pack
32016	25,50	16	8,0	1,50	1
32020	31,00	20	8,5	2,50	1
32024	38,40	24	9,5	3,50	1
32028	49,70	28	11,0	6,50	1

**Cazo Recto**

Casserole  
Stielkasserole, flach  
Saucepan  
Çaçarola direite



Ref	€	Ø (cm)	h (cm)	L	Pack
32214	14,70	14	7,5	1,00	1
32216	17,30	16	8,0	1,50	1
32218	19,10	18	8,5	2,00	1
32220	21,90	20	8,5	2,50	1

**Olla con tapa**

Marmite avec couvercle  
Fleischtopf mit Deckel  
Stock pot with Lid  
Panela com tampa



Ref	€	Ø (cm)	h (cm)	L	Pack
32116	31,00	16	13,0	2,50	1
32120	34,30	20	13,5	4,50	1
32124	43,50	24	15,0	6,50	1
32128	56,50	28	17,0	10,00	1

**Olla super alta con tapa**

Marmite S. Haute a/couvercle  
Hoher Fleischtopf mit Deckel  
Deep Stock pot with Lid  
Panela super alta com tampa



Ref	€	Ø (cm)	h (cm)	L	Pack
32125	53,40	24	20,0	9,00	1
32129	67,30	28	22,5	13,50	1

**Cacerola vapor**

Panier vapeur  
Dampfkoch-Aufsatz  
Steam casserole  
Çaçarola a vapor



Ref	€	Ø (cm)	h (cm)	L	Pack
32420	19,70	20	8,5	2,50	1
32424	23,10	24	9,5	3,50	1

**Tartera con tapa**

Plat rond avec couvercle  
Pfanne mit Deckel  
Round dish with lid  
Tarteira com tampa



Ref	€	Ø (cm)	h (cm)	L	Pack
32624	31,90	24	7,0	3,00	1
32628	45,20	28	8,0	4,50	1

**Colador esférico**

Passoire à queue  
Seiher, mit Stiel  
Strainer  
Coador esférico



Ref	€	Ø (cm)	h (cm)	Pack
32318	29,40	18	8,5	1

**Escurridera**

Passoire sur pied  
Abtropfschüssel  
Colander with stand  
Escorredor



Ref	€	Ø (cm)	h (cm)	Pack
32324	41,30	24	11,0	1

**Pote cilíndrico**

Pot-cilindrique  
Milchtopf  
Cylindrical pot  
Caneca cilíndrica



Ref	€	Ø (cm)	h (cm)	L	Pack
32714	19,40	14	12,5	1,50	1
32716	22,70	16	13,0	2,50	1

**Tapa**

Couvercle  
Deckel  
Lid  
Tampa



Ref	€	Ø (cm)	Pack
32916	7,20	16	1
32920	8,50	20	1
32924	10,20	24	1
32928	12,40	28	1



## Premium



**Toda la pieza ( cuerpo, asas y mangos) fabricada en Acero Inoxidable**  
**Asas y mangos ergonómicos recubiertos en silicona para facilitar un agarre perfecto**  
**Acabado interior y exterior lijado satinado**  
**Apta para todo tipo de cocinas (incluido inducción)**  
**Apta para el lavavajillas**

Toute la pièce (corps, poignées et manches) est fabriquée en acier inoxydable  
 Poignées et manches ergonomiques recouverts de silicone pour faciliter une prise en main parfaite  
 Finition intérieure et extérieure limée satinée  
 Compatible avec tout type de cuisinières (y compris induction)  
 Apte pour le lave-vaisselle

Ganzes Stück (Topf, Griffe und Stiele) aus rostfreiem Stahl  
 Ergonomische Griffe und Stiele mit Silikonbezug für festen Halt  
 Außen- und Innenseite in mattem Schliiff  
 Für alle Herdarten geeignet (inkl. Induktion)  
 Waschmaschinen tauglich

The whole product (body, handles and grips) is made in stainless steel  
 Ergonomic handles and grips with silicone coating to facilitate a perfect grip  
 Sanded, satin interior and exterior finish  
 Suitable for all types of cooking surfaces (including induction)  
 Dishwasher safe

Peça fabricada integralmente (corpo, asas e mangos) em aço inoxidável  
 Asas e mangos ergonómicos revestidos com silicone, para uma sujeição perfeita  
 Acabamento interior e exterior acetinado lixado  
 Apta para todo o tipo de fogões (incluindo placas de indução)  
 Apta para máquinas de lavar louça



### Batería 8 piezas

Batterie 8 pcs.  
 8-Tlg-Batterie  
 Battery 8 pcs.  
 Bateria 8 pcs.

Ref	€	Pack
94000	311,10	1

Cacerola Ø16-20-24 cm  
 Olla Ø16-20 cm  
 Cazo Ø14-16 cm  
 Pote Ø14 cm

### Lote 4 cazos

Ensemble 4 casseroles  
 Set 4 Tlg. Stielkasserollen  
 Set 4 saucepans  
 Lote de 4 caçarola

Ref	€	Pack
94003	117,80	1



Cazo Ø14 cm  
 Ø16 cm  
 Ø18 cm  
 Ø20 cm

**Cacerola con tapa**

Faitout avec couvercle  
Bratentopf mit Deckel  
Casserole with lid  
Çaçarola com tampa



Ref	€	Ø (cm)	h (cm)	L	Pack
94016	38,80	16	8,0	1,50	1
94020	45,50	20	8,5	2,50	1
94024	55,20	24	9,5	3,50	1
94028	69,00	28	11,0	6,50	1

**Cazo Recto**

Casserole  
Stielkasserole, flach  
Saucepan  
Çaçarola direite



Ref	€	Ø (cm)	h (cm)	L	Pack
94214	24,50	14	7,5	1,00	1
94216	28,20	16	8,0	1,50	1
94218	30,70	18	8,5	2,00	1
94220	34,40	20	8,5	2,50	1

**Olla con tapa**

Marmite avec couvercle  
Fleischtopf mit Deckel  
Stock pot with Lid  
Panela com tampa



Ref	€	Ø (cm)	h (cm)	L	Pack
94116	42,10	16	13,0	2,50	1
94120	49,50	20	13,5	4,50	1
94124	60,70	24	15,0	6,50	1
94128	77,60	28	17,0	10,00	1

**Olla super alta con tapa**

Marmite S. Haute a/couvercle  
Hoher Fleischtopf mit Deckel  
Deep Stock pot with Lid  
Panela super alta con tampa



Ref	€	Ø (cm)	h (cm)	L	Pack
94125	64,10	24	20,0	9,00	1
94129	83,10	28	22,5	13,50	1

**Cacerola vapor**

Panier vapeur  
Dampfkoch-Aufsatz  
Steam casserole  
Çaçarola a vapor



Ref	€	Ø (cm)	h (cm)	L	Pack
94420	27,40	20	8,5	2,50	1
94424	31,40	24	9,5	3,50	1

**Tartera con tapa**

Plat rond avec couvercle  
Pfanne mit Deckel  
Round dish with lid  
Tarteira com tampa



Ref	€	Ø (cm)	h (cm)	L	Pack
94620	41,50	20	6,5	2,00	1
94624	50,50	24	7,0	3,00	1
94628	64,30	28	8,0	4,50	1

**Colador esférico**

Passoire à queue  
Seiher, mit Stiel  
Strainer  
Coador esférico



Ref	€	Ø (cm)	h (cm)	Pack
94318	22,50	18	8,5	1

**Escurridera**

Passoire sur pied  
Abtropfschüssel  
Colander with stand  
Escorredor



Ref	€	Ø (cm)	h (cm)	Pack
94324	31,80	24	11,0	1

**Pote cilíndrico**

Pot-cylindrique  
Milchtopf  
Cylindrical pot  
Caneca cilíndrica



Ref	€	Ø (cm)	h (cm)	L	Pack
94714	27,30	14	12,5	1,50	1
94716	31,30	16	13,0	2,50	1

**Tapa**

Couvercle  
Deckel  
Lid  
Tampa



Ref	€	Ø (cm)	Pack
94916	9,40	16	1
94920	10,70	20	1
94924	12,50	24	1
94928	14,60	28	1

## Nova-Ladycor



**Cuerpo fabricado en acero inoxidable 18/10**  
**Asas, mangos y pomo en baquelita termoaislante**  
**Destaca por su diseño clásico, funcionalidad y sencillez práctica**  
**Acabado pulido brillante exterior y lijado mate interior**  
**Triple fondo difusor que asegura un eficiente reparto del calor**  
**Apta para todo tipo de cocinas (Incluido inducción). Apta para el lavavajillas**

Corps fabriqué en acier inoxydable 18/10  
 Poignées, manches et pommeau en bakélite thermo-isolante  
 Se distingue par son style classique, sa fonctionnalité et sa simplicité pratique  
 Finition polie brillante extérieur et limage mat intérieur  
 Triple fond diffuseur qui garantit une répartition efficace de la chaleur  
 Compatible avec tout type de cuisinières (y compris induction). Apte pour le lave-vaisselle

Kessel aus nicht rostendem 18/10-Stahl  
 Griffe, Stiele und Deckelgriff aus wärmeabweisendem Bakelit  
 Punktet mit klassischem Design, Funktionalität und einfacher Handhabung  
 Hochglanzpolierte Außen- und glänzend matte Innenseite  
 Dreifachboden garantiert leistungsstarke Wärmeleitung  
 Für alle Herdarten geeignet (inkl. Induktion). Waschmaschinen tauglich

Body made in 18/10 stainless steel  
 Handles, grips and knob in heat resistant bakelite  
 Stands out for its classic design, functionality and practical simplicity  
 Exterior glossy, polished finish and sanded matte interior.  
 Triple diffuser bottom assuring efficient distribution of heat  
 Suitable for all types of cooking surfaces (including induction). Dishwasher safe

Corpo fabricado em aço inoxidável 18/10  
 Asas, mangos e pomo em baquelite termo-isolante  
 Design clássico, prático e funcional  
 Acabamento exterior brilhante polido, e interior mate lixado  
 Fundo difusor triplo, para uma distribuição eficiente do calor  
 Apta para todo o tipo de fogões (incluido indução). Apta para máquinas de lavar louça



### Batería 8 piezas

Batterie 8 pcs.  
 8-Tlg-Batterie  
 Battery 8 pcs.  
 Bateria 8 pcs.

Ref	€	Pack
88000	280,30	1

Cacerola Ø16-20-24 cm  
 Olla Ø16-20 cm  
 Cazo Ø14-16 cm  
 Pote Ø14 cm

### Cacerola con tapa

Faitout avec couvercle  
 Bratentopf mit Deckel  
 Casserole with lid  
 Caçarola com tampa



Ref	€	Ø (cm)	h (cm)	L	Pack
88016	35,50	16	8,0	1,50	1
88018	38,00	18	8,5	2,00	1
88020	41,30	20	8,5	2,50	1
88022	45,20	22	9,0	3,00	1
88024	48,60	24	9,5	3,50	1
88026	54,50	26	9,5	4,50	1
88028	66,20	28	11,0	9,50	1
88032	84,30	32	12,5	9,50	1

### Cazo Recto

Casserole  
 Stielkasserole, flach  
 Saucepan  
 Caçarola direite



Ref	€	Ø (cm)	h (cm)	L	Pack
88212	21,40	12	7,0	0,80	1
88214	22,10	14	7,5	1,00	1
88216	24,30	16	8,0	1,50	1
88218	26,50	18	8,5	2,00	1
88220	30,30	20	8,5	2,50	1



**Olla con tapa**

Marmite avec couvercle  
Fleischtopf mit Deckel  
Stock pot with Lid  
Panela com tampa

Ref	€	Ø (cm)	h (cm)	L	Pack
88116	39,20	16	13,0	2,50	1
88118	40,80	18	14,0	3,50	1
88120	44,10	20	14,5	4,50	1
88122	48,10	22	14,5	5,50	1
88124	53,30	24	15,0	6,50	1
88126	60,50	26	15,0	7,50	1
88128	73,70	28	17,0	10,00	1
88132	89,00	32	17,5	13,50	1



**Olla super alta con tapa**

Marmite S. Haute a/couvercle  
Hoher Fleischtopf mit Deckel  
Deep Stock pot with Lid  
Panela super alta com tampa

Ref	€	Ø (cm)	h (cm)	L	Pack
88121	47,50	20	17,5	5,50	1
88125	60,90	24	20,0	9,00	1
88129	86,50	28	22,0	13,50	1



**Cacerola vapor**

Panier vapeur  
Dampfkoch-Aufsatz  
Steam casserole  
Çaçarola a vapor

Ref	€	Ø (cm)	h (cm)	L	Pack
88420	32,70	20	9,0	2,50	1
88424	40,50	24	10,5	3,50	1



**Tartera con tapa**

Plat rond avec couvercle  
Pfanne mit Deckel  
Round dish with lid  
Tarteira com tampa

Ref	€	Ø (cm)	h (cm)	L	Pack
88620	40,90	20	6,5	2,00	1
88622	43,90	22	6,5	2,50	1
88624	47,60	24	7,0	3,00	1
88626	50,70	26	7,0	3,50	1
88628	58,20	28	8,0	4,50	1
88632	74,40	32	8,0	6,00	1



**Colador esférico**

Passoire à queue  
Seiher, mit Stiel  
Strainer  
Coador esférico

Ref	€	Ø (cm)	h (cm)	Pack
88318	27,00	18	8,5	1



**Escurridera**

Passoire sur pied  
Abtropfschüssel  
Colander with stand  
Escorredor

Ref	€	Ø (cm)	h (cm)	Pack
88324	38,30	24	11,0	1



**Pote cilíndrico**

Pot-cilindrique  
Milchtopf  
Cylindrical pot  
Caneca cilíndrica

Ref	€	Ø (cm)	h (cm)	L	Pack
88712	23,30	12	12,0	1,00	1
88714	25,10	14	12,5	1,50	1
88716	27,50	16	13,0	2,50	1
88718	30,30	18	14,0	3,50	1

**Tapa**

Couvercle  
Deckel  
Lid  
Tampa

Ref	€	Ø (cm)	Pack
88912	7,40	12	1
88914	8,20	14	1
88916	8,30	16	1
88918	8,40	18	1
88920	8,80	20	1
88922	9,20	22	1
88924	9,80	24	1
88926	10,90	26	1
88928	13,80	28	1
88932	18,90	32	1





## Estudio



**Cuerpo fabricado en acero inoxidable 18/10**  
**Asas, mangos y pomo en baquelita termoaislante**  
**Su pomo abatible consigue una reducción del espacio manteniendo una ergonomía perfecta**  
**Acabado pulido brillante exterior y lijado mate interior**  
**Triple fondo difusor que asegura un eficiente reparto del calor**  
**Apta para todo tipo de cocinas (Incluido inducción). Apta para el lavavajillas**

Corps fabriqué en acier inoxydable 18/10  
 Poignées, manches et pommeau en bakélite thermo-isolante  
 Son pommeau rabattable permet un gain d'espace en conservant une ergonomie parfaite  
 Finition extérieur polie brillante et intérieur limage mat  
 Triple fond diffuseur qui garantit une répartition efficace de la chaleur  
 Compatible avec tout type de cuisinières (y compris induction). Apte pour le lave-vaisselle

Kessel aus nicht rostendem 18/10-Stahl  
 Griffe, Stiele und Deckelgriff aus wärmeabweisendem Bakelit  
 Mit umklappbarem Deckelgriff - platzsparend und sehr ergonomisch  
 Hochglanzpolierte Außen- und matt geschliffene Innenseite  
 Dreifachboden garantiert leistungsstarke Wärmeleitung  
 Für alle Herdarten geeignet (inkl. Induktion). Waschmaschinen tauglich

Body made in 18/10 stainless steel  
 Handles, grips and knob in heat resistant bakelite  
 Its folding knob reduces storage space maintaining ergonomic perfection  
 Exterior glossy, polished finish and sanded matte interior.  
 Triple diffuser bottom assuring efficient distribution of heat  
 Suitable for all types of cooking surfaces (including induction). Dishwasher safe

Corpo fabricado em aço inoxidável 18/10  
 Asas, mangos e pomo em baquelite termo-isolante  
 O pomo rebatível permite reduzir o espaço ocupado conservando a sua ergonomia  
 Acabamento exterior brilhante polido, e mate lixado no interior  
 Fundo difusor triplo, para uma distribuição eficiente do calor  
 Apta para todo o tipo de fogões (incluindo placas de indução). Apta para máquinas de lavar louça



Cacerola Ø16-20-24 cm  
 Olla Ø16-20 cm  
 Cazo Ø14-16 cm  
 Pote Ø14 cm

### Bateria 8 piezas

Batterie 8 pcs.  
 8-Tlg-Batterie  
 Battery 8 pcs.  
 Bateria 8 pcs.

Ref	€	Pack
85000	281,10	1

### Lote 5 cazos

Ensemble 5 casseroles  
 Set 5 Tlg. Stielkasserollen  
 Set 5 saucepans  
 Lote de 5 caçarola

Ref	€	Pack
85003	124,50	1



Cazo Ø12 cm  
 Ø14 cm  
 Ø16 cm  
 Ø18 cm  
 Ø20 cm

**Cacerola con tapa**

Faitout avec couvercle  
Bratentopf mit Deckel  
Casserole with lid  
Çaçarola com tampa



Ref	€	Ø (cm)	h (cm)	L	Pack
85016	35,70	16	8,0	1,50	1
85018	38,10	18	8,5	2,00	1
85020	42,00	20	8,5	2,50	1
85022	45,00	22	9,0	3,00	1
85024	48,20	24	9,5	3,50	1
85026	52,90	26	9,5	4,50	1
85028	61,60	28	11,0	6,50	1
85032	76,30	32	12,5	9,50	1

**Cazo Recto**

Casserole  
Stielkasserole, flach  
Saucepan  
Çaçarola direita



Ref	€	Ø (cm)	h (cm)	L	Pack
85212	21,10	12	7,0	0,80	1
85214	22,10	14	7,5	1,00	1
85216	24,30	16	8,0	1,50	1
85218	26,80	18	8,5	2,00	1
85220	30,10	20	8,5	2,50	1

**Olla con tapa**

Marmite a/couvercle  
Fleischtopf mit Deckel  
Stock pot with Lid  
Panela com tampa



Ref	€	Ø (cm)	h (cm)	L	Pack
85116	38,70	16	13,0	2,50	1
85118	40,70	18	14,0	3,50	1
85120	44,70	20	14,5	4,50	1
85122	49,10	22	14,5	5,50	1
85124	53,60	24	15,0	6,50	1
85126	57,80	26	15,0	7,50	1
85128	69,00	28	17,0	10,00	1
85132	81,40	32	17,5	13,50	1

**Olla super alta con tapa**

Marmite S. Haute a/couvercle  
Hoher Fleischtopf mit Deckel  
Deep Stock pot with Lid  
Panela super alta com tampa



Ref	€	Ø (cm)	h (cm)	L	Pack
85125	61,40	24	20,0	9,00	1
85129	76,30	28	22,0	13,50	1

**Sautex**

Sauteuse  
Sauteuse  
Sauteuse  
Frigideira



Ref	€	Ø (cm)	h (cm)	L	Pack
85624	32,40	24	7,0	3,50	1

**Cacerola vapor**

Panier vapeur  
Dampfkoch-Aufsatz  
Steam casserole  
Çaçarola a vapor



Ref	€	Ø (cm)	h (cm)	L	Pack
85420	31,70	20	9,0	2,50	1
85424	38,60	24	10,5	3,50	1

**Sartén**

Poêle  
Pfanne  
Frying pan  
Sertãs



Ref	€	Ø (cm)	h (cm)	L	Pack
85625	29,60	24	7,0	3,50	1
85629	32,40	28	8,0	4,50	1

**Pote cilíndrico**

Pot-cilindrique  
Milchtopf  
Cylindrical pot  
Caneca cilíndrica



Ref	€	Ø (cm)	h (cm)	L	Pack
85712	23,70	12	12,0	1,00	1
85714	25,30	14	12,5	1,50	1
85716	26,80	16	13,0	2,50	1
85718	29,80	18	14,0	3,50	1

**Tapa**

Couvercle  
Deckel  
Lid  
Tampa



Ref	€	Ø (cm)	Pack
85916	7,40	16	1
85918	7,90	18	1
85920	8,60	20	1
85922	8,90	22	1
85924	9,90	24	1
85926	10,30	26	1
85928	13,40	28	1
85932	18,10	32	1

# Garinox



**Cuerpo fabricado en Acero Inoxidable 18/10**  
**Asas, mangos y pomo en baquelita termoaislante**  
**Acabado pulido brillante**  
**Fondo Termodifusor (Inox 18/10 - Aluminio - Inox)**  
**Apta para todo tipo de cocinas (incluido inducción)**  
**Apta para el lavavajillas**

Corps fabriqué en acier inoxydable 18/10  
 Poignées, manches et pommeau en bakélite thermo-isolante  
 Finition polie brillante  
 Fond thermo-diffuseur (Inox 18/10 - Aluminium - Inox)  
 Compatible avec tout type de cuisinières (y compris induction)  
 Apte pour le lave-vaisselle

Kessel aus nicht rostendem 18/10-Stahl  
 Griffe, Stiele und Deckelgriff aus wärmeabweisendem Bakelit  
 Hochglanzpoliert  
 Wärmeleitender Boden (Edelstahl 18/10 - Aluminium - Edelstahl)  
 Für alle Herdarten geeignet (inkl. Induktion)  
 Waschmaschinen tauglich

Body made in 18/10 stainless steel  
 Handles, grips and knob in heat resistant bakelite  
 Glossy polished finish  
 Heat diffuser bottom (18/10 stainless steel - Aluminium - Stainless Steel)  
 Suitable for all types of cooking surfaces (including induction)  
 Dishwasher safe

Corpo fabricado em aço inoxidável 18/10  
 Asas, mangos e pomo em baquelite termo-isolante  
 Acabamento brilhante polido  
 Fundo termodifusor (Inox 18/10 - Alumínio - Inox)  
 Apta para todo o tipo de fogões (incluindo placas de indução)  
 Apta para máquinas de lavar louça



**Cacerola con tapa**  
 Faitout a/couvercle  
 Bratentopf mit Deckel  
 Casserole with lid  
 Caçarola com tampa

Ref	€	Ø (cm)	h (cm)	L	Pack
14318	22,50	18	9,0	2,00	1
14320	26,00	20	10,0	3,00	1
14322	30,60	22	11,0	4,00	1
14324	35,40	24	12,0	5,00	1



**Olla con tapa**  
 Marmite avec couvercle  
 Fleischtopf mit Deckel  
 Stock pot with Lid  
 Panela com tampa

Ref	€	Ø (cm)	h (cm)	L	Pack
14420	27,80	20	12,0	3,80	1
14422	32,60	22	13,0	5,00	1
14424	39,10	24	15,0	7,00	1

**Cazo Recto**  
 Casserole  
 Stielkasserole, flach  
 Saucepan  
 Caçarola direite



Ref	€	Ø (cm)	h (cm)	L	Pack
14212	8,00	12	5,5	0,60	1
14214	9,90	14	6,5	1,50	1
14216	12,50	16	7,5	1,50	1
14218	15,00	18	9,0	2,00	1
14220	17,60	20	10,0	3,00	1



**Lote 5 cazos**  
 Ensemble 5 casseroles  
 Set 5 Tlg. Stielkasserollen  
 Set 5 saucepans  
 Lote de 5 caçarola

Ref	€	Pack
14205	63,00	1

Cazo Ø12 cm  
 Ø14 cm  
 Ø16 cm  
 Ø18 cm  
 Ø20 cm

## Trimetal



**TRImetal**  
· DESIGNED ·



**Cuerpo fabricado en 3 capas: acero inoxidable 18/10, aluminio, acero inoxidable 18%**  
El aluminio interior garantiza una cocción uniforme de los alimentos. Además de un ahorro importante en el uso de energía necesaria.  
La capa exterior, es de acero inoxidable con componentes ferríticos, lo que la convierte totalmente compatible con las cocinas de inducción  
Las asas y los mangos están fabricados en acero inoxidable 18/10 y recubiertas con un protector térmico de silicona para facilitar un agarre perfecto y seguro.  
La tapa de vidrio cuenta con un borde de silicona que le permite un cierre más eficiente y retener mayor calor, logrando así una mejor cocción

Corps fabriqué avec 3 couches : acier inoxydable 18/10, aluminium, acier inoxydable 18%  
L'aluminium intérieur garantit une cuisson uniforme des aliments, ainsi qu'une importante économie de l'utilisation de l'énergie nécessaire  
La couche extérieure est en acier inoxydable avec des composants ferritiques, ce qui lui permet d'être totalement compatible avec les cuisinières à induction  
Les poignées et les manches sont fabriqués en acier inoxydable 18/10 et recouverts d'une protection thermique en silicone pour faciliter une prise en main parfaite et sûre  
Le couvercle en verre possède un bord en silicone qui lui permet une fermeture plus efficace et de retenir davantage de chaleur, obtenant ainsi une meilleure cuisson

Kessel aus dreilagigem Material: rostfreier Stahl 18/10, Aluminium, rostfreier Stahl 18%  
Zwischenlage aus Aluminium gewährleistet gleichmäßigen Kochvorgang und wirkt energiesparend

Induktionsherdgeeignet dank Außenschicht aus rostfreiem Stahl mit ferritischen Bestandteilen  
Die Griffe und Stiele aus rostfreiem Stahl 18/10 und mit wärmeabweisender Silikonummantelung geben sicheren und perfekten Halt  
Der Glasdeckel mit Silikonumrandung sorgt für festen Verschluss und Wärmerückhalt und damit für einen optimierten Kochvorgang

Body manufactured in a 3-layered: 18/19 stainless steel, aluminium, 18% stainless steel  
The interior aluminium guarantees uniform cooking of the food. Besides an important savings in the use of the necessary energy  
Exterior layer, of stainless steel with ferrite materials, making it completely compatible with inductio cookers  
The handles and grips are made in 18/10 stainless steel and covered in a silicon heat protection for easy and safe gripping  
The glass cover has a silicone border permitting a more efficient covering and heat retention, resulting in better cooking

Corpo fabricado em 3 capas: aço inoxidável 18/10, alumínio, aço inoxidável 18%  
O interior de alumínio garante uma cocção uniforme dos alimentos, e uma grande poupança de energia  
Capa exterior de aço inoxidável com componentes ferríticos, totalmente compatível com as placas de indução  
Asas e mangos fabricados em aço Inoxidável 18/10, revestidos com um protetor térmico de silicone para uma sujeição perfeita e segura  
Tampa de vidro com rebordo de silicone, para um fecho mais eficiente e uma maior retenção do calor, proporcionando uma cocção melhor dos alimentos

### Cacerola con tapa

Faitout avec couvercle  
Bratentopf mit Deckel  
Casserole with lid  
Caçarola com tampa



### Cazo recto

casserole  
Stielkasserole, flach  
Saucepan  
Caçarola direita



Ref	€	Ø (cm)	h (cm)	L	Pack
53016	58,00	16	9,0	1,80	1
53018	67,50	18	10,0	2,50	1
53020	75,20	20	11,0	3,50	1
53024	89,30	24	13,0	5,50	1

Ref	€	Ø (cm)	h (cm)	L	Pack
53214	38,70	14	7,0	0,80	1
53216	42,30	16	8,0	1,30	1
53218	46,80	18	9,0	2,00	1
53220	52,20	20	10,0	3,00	1





**Tapa**  
Couverture  
Deckel  
Lid  
Tampa

Ref	€	Ø (cm)	Pack
53916	15,90	16	1
53918	16,40	18	1
53920	17,10	20	1
53924	17,80	24	1



**Sautex**  
Sauteuse  
Sauteuse  
Sauteuse  
Frigideira

Ref	€	Ø (cm)	h (cm)	L	Pack
53625	58,30	24	7,0	2,60	1



**Sartén**  
Poêle  
Pfanne  
Frying pan  
Sertã

Ref	€	Ø (cm)	h (cm)	L	Pack
53720	44,10	20	4,5	1,00	1
53724	49,10	24	5,0	1,50	1
53728	60,30	28	5,5	2,50	1



**Sartén antiadherente**  
Poêle antiadherent  
Pfanne, Antihalt  
Non-stick frying pan  
Sertã anti-aderente

Ref	€	Ø (cm)	h (cm)	L	Pack
53721	51,40	20	4,5	1,00	1
53725	61,50	24	5,0	1,50	1
53729	77,70	28	5,5	2,50	1

**New**



**Wok**  
Wok  
Wok  
Wok  
Wok

Ref	€	Ø (cm)	h (cm)	L	Pack
53828	66,80	28	8,0	3	1

**New**



**Wok antiadherente**  
Wok, Antiadherent  
Wok, Antihalt  
Wok, non-stick  
Wok anti-aderente

Ref	€	Ø (cm)	h (cm)	L	Pack
53829	74,30	28	8,0	3	1

## Forte



**Fabricada en Aluminio fundido y construida en una sola pieza**  
**Máxima robustez y gran resistencia a la deformación**  
**Es la pieza ideal para guisos, cocidos, sopas y salsas**  
**Revestimiento antiadherente interior y exterior, libre de PFOA**  
**Apta para todo tipo de cocinas (Incluido inducción). Apta para el lavavajillas**  
**Incluye una tapa de vidrio templado con válvula resistente a los golpes (excepto cazo)**

Fabriquée en fonte d'aluminium et construite en une seule pièce  
 Robustesse maximale et grande résistance à la déformation  
 C'est la pièce idéale pour les ragoûts, pot-au-feu, soupes et sauces  
 Revêtement antiadhésif intérieur et extérieur sans PFOA  
 Compatible avec tout type de cuisinières (y compris induction). Apte pour le lave-vaisselle  
 Inclut un couvercle en verre trempé avec soupape résistante aux chocs (excepté la casserole)

In einem Stück aus Aluminium gegossen  
 Höchst widerstandsfähig und formbeständig  
 Ideal für Schmorgerichte, Eintöpfe, Suppen und Soßen  
 Antihafbeschichtung innen und außen, ohne PFOA  
 Für alle Herdarten geeignet (inkl. Induktion). Waschmaschinen tauglich  
 Deckel aus gehärtetem Glas mit stoßfestem Ventil (außer Topf)

Made in Cast Aluminium and in a single piece  
 Maximum robustness and great resistance to deformation  
 This is the ideal product for stews, soups and sauces.  
 Interior non-stick coating and exterior, PFOA free  
 Suitable for all types of cooking surfaces (including induction). Dishwasher safe  
 It includes a tempered glass cover with pressure valve resistant to bumps (except small pot)

Fabricada em alumínio fundido e como uma única peça  
 Máxima robustez e grande resistência à deformação  
 Ideal para estofados, cozidos, sopas e molhos  
 Revestimento antiaderente interior e exterior, isento de PFOA  
 Apta para todo o tipo de fogões (incl. placas de indução). Apta para máquinas de lavar louça  
 Tampa de vidro temperado com válvula, resistente aos golpes (exceto caçarola)

### Cacerola con tapa cristal

Faitout avec couvercle verre  
 Bratentopf mit Glasdeckel  
 Round casserole with glass lid  
 Caçarola com tampa de vidro



### Cacerola baja con tapa cristal

Faitout bas avec couvercle verre  
 Bratentopf mit Glasdeckel  
 Round low casserole with glass lid  
 Caçarola baixa com tampa de vidro



Ref	€	Ø (cm)	h (cm)	L	Pack
25816	24,50	16	8,5	1,50	8
25820	26,50	20	8,5	2,50	8
25824	33,00	24	10,5	4,50	8
25828	40,90	28	12,5	7,00	8
25831	48,50	30	13,5	8,70	8

Ref	€	Ø (cm)	h (cm)	L	Pack
25823	33,20	24	7,5	2,60	8
25827	40,70	28	7,5	3,60	4
25832	52,70	32	7,5	5,20	4
25835	60,90	36	8,5	7,50	4

### Cacerola cuadrada con tapa cristal

Faitout carré avec couvercle verre  
 Bratentopf mit Glasdeckel  
 Square casserole with glass lid  
 Caçarola quadrada com tampa de vidro



### Cacerola baja cuadrada c/tapa cristal

Faitout basse carré a/couvercle verre  
 Bratentopf mit Glasdeckel  
 Square low square casserole w/lid  
 Caçarola baixa quadrada c/ tampa de vidro



Ref	€	cm	h (cm)	L	Pack
25821	31,10	20x20	8,0	2,70	8
25825	38,60	24x24	10,0	4,70	8
25829	48,60	28x28	12,0	7,50	8

Ref	€	cm	h (cm)	L	Pack
25830	47,30	28x28	9,0	4,20	4

### Cazo Recto

Casserole  
 Stielkasserole, flach  
 Saucepan  
 Caçarola direita



Ref	€	Ø (cm)	h (cm)	L	Pack
25815	28,50	16	7,5	1,20	1
25817	30,60	18	9,0	1,80	1

## Stilo



**Construidas en aluminio fundido de una sola pieza**  
**Garantiza una resistencia máxima y una distribución homogénea del calor**  
**Revestimiento antiadherente de alta calidad y ecológico, libre de PFOA**  
**Reforzada con un acabado en piedra**  
**Pomo y asa SOFT TOUCH. Tapa de cristal con cierre de silicona**  
**Apta para todo tipo de cocinas, incluida la inducción**

Fabriquéés en fonte d'aluminium d'une seule pièce  
 Garantit une résistance maximale et une distribution homogène de la chaleur  
 Revêtement antiadhésif de grande qualité et écologique, sans PFOA  
 Renforcée avec une finition en pierre  
 Pommeau et poignée SOFT TOUCH. Couvercle en verre avec fermeture en silicone  
 Compatible avec tout type de cuisinières, y compris à induction

In einem Stück aus Aluminium gegossen  
 Gewährleistet höchste Widerstandsfähigkeit und gleichmäßige Wärmeverteilung  
 Umweltfreundliche und qualitätsvolle Antihaftbeschichtung ohne PFOA  
 Mit Steinbeschichtung gehärtet  
 SOFT TOUCH-Griff an Pfanne und Deckel Glasdeckel mit Silikondichtung  
 Für alle Herdarten geeignet, inkl. Induktion

Made in a single, cast aluminum body  
 This guarantees maximum resistance and a homogeneous distribution of heat  
 Its high quality and eco-friendly non-stick coating is PFOA-free  
 Reinforced with a stone finish  
 SOFT TOUCH knob and handle Glass cover with silicon seal  
 Apt for all types of cooking surfaces (including induction)

Fabricadas em alumínio fundido de uma só peça  
 Oferece máxima resistência e uma distribuição homogénea do calor  
 Revestimento antiaderente de alta qualidade e ecológico, isento de PFOA  
 Reforçadas com acabamento em pedra  
 Pomo e asa SOFT TOUCH. Tapa de vidro com fecho de silicone  
 Aptas para todo o tipo de placas, incluindo as de indução

### Cacerola con tapa cristal

Faitout avec couvercle verre  
 Bratentopf mit Glasdeckel  
 Casserole with glass lid  
 Caçarola com tampa de vidro



Ref	€	Ø (cm)	h (cm)	L	Pack
27320	41,40	20	10,5	2,50	1
27324	48,10	24	12,0	4,00	1
27328	56,80	28	12,5	6,00	1

### Cacerola baja con tapa cristal

Faitout bas avec couvercle verre  
 Bratentopf mit Glasdeckel  
 Low casserole with glass lid  
 Caçarola baixa com tampa de vidro



Ref	€	Ø (cm)	h (cm)	L	Pack
27327	53,60	28	8,5	4,00	1

### Cazo recto

Casserole  
 Stielkasserole, flach  
 Saucepan  
 Caçarola direita



Ref	€	Ø (cm)	h (cm)	L	Pack
27416	26,40	16	7,5	1,20	1
27418	28,20	18	8,8	1,80	1

### Tapa cristal

Couvercle verre  
 Glasdeckel  
 Glass lid  
 Tapa de vidro



Ref	€	Ø (cm)	Pack
27920	6,80	20	1
27924	8,00	24	1
27928	9,90	28	1

### Sartén

Poêle  
 Pfanne  
 Frying pan  
 Sertã



Ref	€	Ø (cm)	h (cm)	Pack
27620	27,60	20	4,5	1
27624	31,40	24	5,2	1
27626	34,80	26	5,5	1
27628	37,60	28	6,0	1

### Grill

Grill  
 Grill Induktionfähig  
 Grill  
 Grelhador



Ref	€	cm	h (cm)	Pack
27625	34,50	24x24	4,8	1
27629	39,90	28x28	5,2	1

## Fundición: Cocottes



### Fabricadas en aluminio fundido

Garantizan la absorción y distribución uniforme del calor, sin puntos de sobrecalentamiento

La distribución del calor uniforme por toda la pieza hace que los alimentos no pierdan su jugo durante la cocción, conservando así todos sus nutrientes y vitaminas

Las puntas situadas bajo la tapa, hacen que las gotas fruto de la condensación, vuelvan a caer sobre los alimentos formando un flujo circulante y permanente

reduciendo la pérdida de sabores y jugos de los alimentos

Es la pieza perfecta para: arroces, carnes, pescados, legumbres, verduras, guisos, cremas, salsas, sopas, etc.

Revestimiento antiadherente interior y exterior ILAG:ULTIMATE

Diseño atractivo y funcional

Fabriqué en fonte d'aluminium

Garantit l'absorption et la distribution uniforme de la chaleur, sans points de surchauffe

La distribution de la chaleur uniforme sur toute la pièce permet aux aliments de ne pas perdre leur jus pendant la cuisson, conservant ainsi tous leurs nutriments et vitamines Les pointes situées sous le couvercle permettent aux gouttes issues de la condensation de retomber sur les aliments, formant ainsi un flux permanent de circulation qui réduit la perte des saveurs et des jus des aliments

C'est la pièce parfaite pour : riz, viandes, poissons, légumes, ragoûts, crèmes, sauces, soupes, etc.

Revêtement antiadhésif intérieur et extérieur ILAG: ULTIMATE

Style attractif et grande fonctionnalité

Aus gegossenem Aluminium

Garantiert gleichmäßige Wärmeaufnahme und -verteilung ohne Überhitzungspunkte

Gleichmäßige Wärmeverteilung im gesamten Kessel erhalten die Lebensmittel beim Kochen saftig und somit auch alle ihre Nährstoffe und Vitamine

Die Spitzen unter dem Deckel bewirken, dass die Kondensationstropfen wieder auf das Kochgut tropfen und so einen permanent zirkulierenden Fluss darstellen, der den Verlust von Geschmack und Flüssigkeit der Lebensmittel verhindert

Ideal für Reis, Fleisch, Fisch, Hülsenfrüchte, Gemüse, Schmorgerichte, Cremes, Soßen, Suppen usw.

Antihafbeschichtung innen und außen ILAG: ULTIMATE

Attraktives Design und funktionelle Beschaffenheit

Made in cast aluminium

It guarantees the absorption and uniform distribution of heat, without overheating points

The uniform distribution of heat throughout the product makes keep its juices during cooking, preserving all its nutrients and vitamins

The points located under the lid cause the condensation drops to fall back onto the food, forming a permanent and circulating flow and reducing the loss of the food's flavours and juices

This is an ideal product for: rice, meats, fish, beans, vegetables, stews, creams, sauces, soups, etc.

Interior and exterior non-stick coating ILAG: ULTIMATE

Attractive design and great functionality

Fabricadas em alumínio fundido

Garantem a absorção e a distribuição uniforme do calor, sem pontos de sobreaquecimento

A distribuição uniforme do calor por toda a peça faz com que os alimentos não percam o seu suco durante a cocção, conservando assim todos os seus nutrientes e vitaminas

As pontas situadas sob a tampa fazem com que as gotas produzidas pela condensação voltem a cair sobre os alimentos, formando um fluxo circulante e permanente, reduzindo a perda de sabores e de líquidos dos alimentos

Ideal para cozinhar arrozes, carnes, peixes, legumes, verduras, guisados, cremes, molhos, sopas, etc.

Revestimento antiaderente interior e exterior ILAG: ULTIMATE

Design atraente funcional



## Fundición: Cocottes

### Cacerola con tapa MINI

Faitout avec couvercle "MINI"  
"MINI" Bratentopf mit Deckel  
"MINI" round casserole with lid  
Çaçarola com tampa "MINI"



### Cacerola con tapa MINI negra

Faitout avec couvercle MINI noir  
MINI Bratentopf mit Deckel, grau  
"MINI" black round casserole with lid  
Çaçarola com tampa MINI negra



Ref	€	Ø (cm)	h (cm)	L	Pack
25909	18,20	10	5,0	0,24	12
25914	26,90	14	7,5	0,90	12

Ref	€	Ø (cm)	h (cm)	L	Pack
25910	18,20	10	5,0	0,24	12
25915	26,90	14	7,5	0,90	12

### Cacerola oval con tapa MINI

Faitout Ovale avec couvercle "MINI"  
"MINI" Oval Bratentopf mit Deckel  
"MINI" oval round casserole with lid  
Çaçarola oval com tampa "MINI"



### Cacerola oval con tapa MINI negra

Faitout ovale avec couvercle MINI noir  
MINI Oval Bratentopf mit Deckel, grau  
"MINI" black oval round casserole with lid  
Çaçarola oval com tampa MINI negra



Ref	€	cm	h (cm)	L	Pack
25911	19,20	12x8,5	5,0	0,25	12

Ref	€	cm	h (cm)	L	Pack
25912	18,10	12x8,5	5,0	0,25	12

*Incluye manoplas de silicona*  
*Includes silicone mittens*

### Cacerola con tapa

Faitout avec couvercle  
Bratentopf mit Deckel  
Round casserole with lid  
Çaçarola com tampa



### Cacerola con tapa negra

Faitout avec couvercle noir  
Bratentopf mit Deckel, grau  
Black round casserole with lid  
Çaçarola com tampa negra



Ref	€	Ø (cm)	h (cm)	L	Pack
25916	39,30	16	7,0	1,30	12
25920	51,20	20	8,0	2,40	6
25924	66,10	24	10,0	4,20	6
25928	84,30	28	11,5	6,70	4

Ref	€	Ø (cm)	h (cm)	L	Pack
25917	43,60	16	7,0	1,30	12
25921	57,50	20	8,0	2,40	6
25925	72,00	24	10,0	4,20	4
25929	88,20	28	11,5	6,70	4

*Incluye manoplas de silicona*  
*Includes silicone mittens*

### Cacerola oval con tapa

Faitout Ovale avec couvercle  
Oval Bratentopf mit Deckel  
Oval round casserole with lid  
Çaçarola oval com tampa



### Cacerola oval con tapa negra

Faitout ovale avec couvercle noir  
Oval Bratentopf mit Deckel, grau  
Black oval round casserole with lid  
Çaçarola oval com tampa negra



Ref	€	cm	h (cm)	L	Pack
25927	60,90	26x20	9,0	3,50	4
25931	83,60	31x25	11,0	6,30	4

Ref	€	cm	h (cm)	L	Pack
25933	65,80	26x20	9,0	3,50	4
25935	90,60	31x25	11,0	6,30	4



**Manoplas de silicona**

Mouflettes en silicone

Fäustling aus Silikon

Silicone mittlen

Pegas de silicone

Ref	€	Ø (cm)	Pack
R25921C	6,70	20-24-28	1
R25935C	6,70	31x25	1

**New**



**Manoplas de silicona GRIS**

Mouflettes en silicone

Fäustling aus Silikon

Silicone mittlen

Pegas de silicone

Ref	€	Ø (cm)	Pack
R25921G	6,20	20-24-28	1
R25935G	6,20	31x25	1

# Magma



Hierro Fundido  
Cast Iron

**Construida en una sola pieza**  
**Recubierta con una capa de aceite vegetal**  
**Ideal para cocinar, prolonga suavemente la cocción**  
**Gran conductor del calor, mantiene el calor mientras disfrutas y saboreas la comida**  
**Base de madera para servir y presentar la comida recién cocinada**

Construite en une seule pièce  
 Revêtu d'une couche d'huile végétale  
 Idéal pour cuisiner, prolonge délicatement la cuisson  
 Grand conducteur de chaleur, maintient le plat au chaud pendant que vous dégustez la nourriture  
 Base en bois pour servir et présenter le plat fraîchement cuisiné

Aus einem Stück gefertigt  
 Beschichtet mit einer Schicht von Pflanzenöl  
 Ideal zum Kochen, verlängert den Kochvorgang auf sanfte Weise  
 Hervorragender Wärmeleiter; erhält die Wärme während Sie die Speisen genießen  
 Holzbasis, auf der das soeben zubereitete Gericht serviert und präsentiert wird

Built in one piece  
 Coated with a layer of vegetable oil  
 Ideal for cooking; gently continues to cook  
 Great heat conductor; retains heat while you enjoy and savour the food  
 Wooden base to serve and present freshly cooked food

Elementos fabricados a partir de uma única peça  
 Revestidos com uma camada de óleo vegetal  
 Ideal para cozinhar, prolonga suavemente a cocção  
 Excelente condutor do calor, mantém o calor enquanto desfrutas da comida  
 Base de madeira para servir e apresentar a comida recém-preparada



**Cacerola con base**

Faitout avec basse  
 Bratentopf mit Holzsockel  
 Casserola with base  
 Caçarola com base

Ref	€	Ø (cm)	ml	Pack
25871	12,40	12,0	150	1
25872	17,00	15,5	300	1
25873	21,80	18,0	600	1

**New**



**Cacerola oval con base**

Faitout ovale avec basse  
 Oval Bratentopf mit Holzsockel  
 Oval casserola with base  
 Caçarola oval com base

Ref	€	cm	ml	Pack
25881	12,50	15x10	200	1
25882	19,30	17,5x12,5	300	1
25883	21,60	21,7x15	700	1

**New**

**New**



**Cacerola sin base**

Faitout sans basse  
 Bratentopf ohne Holzsockel  
 Casserola without base  
 Caçarola sem base

Ref	€	Ø (cm)	ml	Pack
25771	8,50	12,0	150	1
25772	12,50	15,5	300	1
25773	15,10	18,0	600	1

**New**



**Cacerola oval sin base**

Faitout ovale sans basse  
 Oval Bratentopf ohne Holzsockel  
 Oval casserola without base  
 Caçarola oval sem base

Ref	€	cm	ml	Pack
25781	9,80	15x10	200	1
25782	15,30	17,5x12,5	300	1
25783	17,40	21,7x15	700	1

**New**



**Mini Plancha Grill lisa rectangular**

Mini Plaque Grill lisse rectangulaire  
Mini Platte Grill, glatt, rechteckiger  
Mini rectangular Grill plaque flat  
Mini Plancha Grill liso rectangular

Ref	€	cm	h (cm)	Pack
25874	12,20	22,5x10	2,5	1

**New**



**Mini Plancha Grill cuadrado**

Mini Plaque Grill carré  
Mini Platte Grill, Quadrat  
Mini square Grill plaque  
Mini Plancha Grill cuadrado

Ref	€	cm	h (cm)	Pack
25875	12,20	19,5x14	1,7	1

**New**



**Mini Grill**

Mini Grill  
Mini Grill  
Mini Grill  
Mini Grill

Ref	€	cm	h (cm)	Pack
25876	13,90	21x13,5	2,5	1

**New**



**Mini sartén lisa**

Mini poêle lisse  
Mini Pfanne  
Mini frying pan flat  
Mini sertã lisa

Ref	€	cm	h (cm)	Pack
25877	12,90	22x12,5	1,7	1



## Fondue



### Fondue 6 personas con base cristal

Service à Fondue sur socle en verre  
Fondue für 6 Personen mit Glasfuß, Rostfrei  
6 People St. Steel Fondue w/glass lazy susan  
Fondue 6 pessoas com base vidro

Ref	€	L	Pack
71710	122,90	2,00	1

Lacor dispone de 2 tipos de fondue, una con base de cristal y otra sin base, ambas para 6 personas

Fabricadas en acero inoxidable de máxima calidad y resistencia  
Constan de un recipiente con asas anticalentamiento, un quemador, 6 tenedores-pinchos y 6 cucharas de diferentes colores para diferenciarlos, y 6 tazas  
Un recurso muy demandado tanto en cocina profesional como en cocina doméstica por su gran versatilidad  
Ideal para reuniones familiares, fiestas infantiles, eventos, catering, comidas informales, etc... porque puede servir tanto para preparar un entrante de queso como una comida principal de carne e incluso el postre de chocolate combinado con frutas

Lacor dispose de 2 types de fondues, l'une avec une base en verre et l'autre sans base, toutes deux pour 6 personnes.

Fabriquées en acier inoxydable d'une qualité et d'une résistance maximales. Elles disposent d'un récipient avec des poignées anti-chauffe, un brûleur, 6 fourchettes-piques et 6 cuillères de différentes couleurs pour les différencier, et 6 tasses.

Un accessoire très demandé aussi bien dans une cuisine professionnelle qu'une cuisine domestique, en raison de sa grande versatilité.

Idéale pour les réunions de famille, fêtes pour enfants, événements, buffets, repas informels, etc. car elle peut aussi bien servir pour préparer une entrée de fromage qu'un plat principal de viande et même un dessert au chocolat combiné avec des fruits.

Lacor hat zwei Arten von Fondue-Sets, eins mit Glasfuß und eins ohne Fuß, beide für 6 Personen.

Aus rostfreiem und widerstandsfähigem Edelstahl hergestellt.

Sets bestehen aus einem Topf mit hitzeisolierten Griffen, einem Brenner, 6 Steckgabeln, 6 farbig markierten Löffeln und 6 Tassen.

Küchenutensil, das wegen seiner Vielseitigkeit sowohl bei Haus- als auch Profiköchen gefragt ist.

Ideal für Familientreffen, Kindergeburtstage, Veranstaltungen, Catering, gemütliches Beisammensein, etc. Dient sowohl für Käsevorspeisen sowie für Hauptgänge aus Fleisch und sogar für den Schoko-Dessert mit Früchten.

Lacor has 2 types of fondue, one with a glass base and the other without a base, both for 6 people.

Made of stainless steel of the highest quality and strength.

They include a pot with heat-resistant handle, a burner, 6 forks-skewers and 6 spoons in different colours to differentiate them, and 6 cups.

A highly sought after asset in both professional and household cooking thanks to its versatility.

Ideal for family reunions, children's parties, events, catering, informal meals, etc... as it can be used to prepare a cheese starter, a main meal with meat and even a chocolate and fruit dessert.

Lacor dispõe de 2 tipos de fondue para 6 pessoas, uma com base de vidro e outra sem base.

Fabricadas em aço inoxidável da máxima qualidade e resistência.

Os fondue são compostos por um recipiente com asas anti-aquecimento, um queimador, 6 garfos-espantos, 6 colheres de diferentes cores e 6 tigelas.

Um recurso muito procurado, tanto nas cozinhas profissionais como domésticas, pela sua grande versatilidade.

Ideal para reuniões familiares, festas infantis, eventos, catering, almoços informais, etc. Pode servir tanto para preparar uma entrada de queijo como uma refeição principal de carne, ou uma sobremesa de chocolate combinada com frutas.



### Fondue 6 personas sin base

Service à Fondue pour 6 personnes  
Fondue für 6 Personen, Rostfrei  
6 People St. Steel Fondue  
Fondue 6 pessoas sem base vidro

Ref	€	L	Pack
71723	78,00	2,00	1

### 6 pinchos Fondue

Jeu 6 fourchettes à Fondue  
6 Fonduespiesse, Rostfrei  
6 Pcs. Fondue forks  
6 espetos Fondue

Ref	€	L (cm)	Pack
R71710	6,90	25	1

### 6 cucharas Fondue

Jeu 6 cuillères à Fondue  
6 Fonduelöffel, Rostfrei  
6 Pcs. Fondue spoons  
6 colheres Fondue

Ref	€	L (cm)	Pack
R71711	6,70	15	1

### Taza Inox Fondue

Bol à Fondue  
Fonduetasse, Rostfrei  
St. Steel Fondue cup  
Taça Inox Fondue

Ref	€	Ø Interior (cm)	Ø Exterior (cm)
R71723	2,10	9	8,6



## Gel

**El gel combustible destinado a uso gastronómico es de origen orgánico, alcohol procedente de origen vegetal**  
**Encendido rápido y combustión silenciosa, limpia, inodora, sin humos y sin cenizas. No produce emanaciones tóxicas**  
**Su presentación en gel evita accidentes por derrame o caídas, por lo que es eficaz y seguro**

Le gel combustible destiné à un usage lié à la cuisine est d'origine organique, l'alcool étant d'origine végétale.  
 Allumage rapide et combustion silencieuse, propre, inodore, sans fumée et sans cendres. Ne produit pas d'émanations toxiques.  
 Sa présentation en gel évite les accidents dus à des fuites ou des chutes, c'est pourquoi il est efficace et sûr.

Das Brenngel für gastronomischen Gebrauch ist organisch. Der Alkohol ist pflanzlichen Ursprungs.  
 Schnelles Anzünden. Brennt sauber, geräusch- und geruchlos, ohne Rauch oder Asche. Verströmt keine giftigen Dämpfe  
 Gelförmige Darbietung verhindert Unfälle durch Verschütten oder Herunterfallen und ist daher leistungsstark und sicher

This organic gel fuel for culinary use is made from vegetable-based alcohol  
 Quick-lighting and quiet-burning, clean, odourless, smokeless and ash-free  
 Does not produce toxic fumes  
 Its gel form avoids accidents due to spilling or dropping, which makes it effective and safe

Este gel combustível destinado a uso gastronómico é de origem orgânica, e utiliza álcool de origem vegetal  
 Ignição rápida e combustão silenciosa e limpa, inodora, sem fumos e sem cinzas. Não produz emanações tóxicas  
 A sua apresentação em forma de gel evita acidentes por derrame ou quedas, o que o torna mais eficaz e seguro

### Contenedor de combustible

Porte-brûleur  
 Brennpasten-Behälter  
 Burner holder  
 Recipiente de combustível



Ref	€	Ø (cm)	h (cm)	Asa L (cm)	Pack
69006	19,40	9,0	6,0	7,0	1

### Pack 3 latas combustible Fondue

Pack de 3 boîtes FGel de chauffe  
 Brennpasten  
 3 can Fondue burning Gel  
 Pack 3 latas combustível Fondue



Ref	€	g	Minutos	Pack
71780	3,60	80	80	1

### Botellas gel ETANOL

Flacon al alcool gelifie ETHANOL  
 Flasche, ETHYALKOHOL  
 Bottle, ETHANOL  
 Garrafas de gel ETANOL



Ref	€	g	Pack
69107	6,80	840	12

### Lata gel combustible ETANOL

Boîte gel chauffe ETHANOL  
 Brennpaste, ETHYALKOHOL  
 Fuel gel can, ETHANOL  
 Lata de gel combustível ETANOL



Ref	€	g	Horas	Pack
69108	2,10	225	3	72

### Bidón gel combustible ETANOL

Bidon gel chauffe ETHANOL  
 Bidon, ETHYALKOHOL  
 Fuel gel barrel, ETHANOL  
 Bidón de gel combustível ETANOL



Ref	€	Kg	Pack
69109	31,10	4,0	72



Ollas a presión  
Pressure Cookers

#CocinaConLacor



## Chef-Luxe



**Sistema de apertura y cierre con una sola mano**  
**Selección de posiciones (3 posiciones: 0 - I - II)**  
**Se puede utilizar como una cacerola normal**

Ouverture et de fermeture d'une seule main  
 Sélection positions (3 positions: 0 - I - II)  
 Peut être utilisé comme une casserole normale

Das Öffnen und Schließen mit einer Hand  
 Auswählen Stellungen (3 Position: 0 - I - II)  
 Kann als normaler als normaler bratentopf

Opening and closing system with one hand  
 Selecting positions (3 position: 0 - I - II)  
 Can be used as a normal casserole

Sistema de abertura e fechar com uma mão  
 A seleção de posições (3 posições: 0 - I - II)  
 Pode ser usado como uma panela normais



### Olla a presión LUXE

Cocotte à pression Luxe  
 Luxe Schnellkochtopf  
 Luxe Pressure cooker  
 Panela de pressão

Ref	€	Ø (cm)	h (cm)	L	Pack
50815	473,10	32	18,0	15,0	1
50818	486,90	32	23,0	18,0	1
50823	506,50	32	32,0	22,0	1

### Cuerpo Olla a presión LUXE

Corps Cocotte à pression Luxe  
 Schnellkochtopf-Körper Luxe  
 Luxe Pressure cooker stockpot  
 Corpo panela de pressão

Ref	€	Ø (cm)	h (cm)	L	Pack
50816	138,40	32	18,0	15,0	1
50819	152,70	32	23,0	18,0	1
50824	172,80	32	32,0	22,0	1



### Tapa

Couvercle  
 Deckel  
 Lid  
 Tampa



Ref	€	Ø (cm)	Pack
50933	309,90	32	1

### Tapa

Couvercle  
 Deckel  
 Lid  
 Tampa



Ref	€	Ø (cm)	Pack
54932	21,30	32	1



## Chef



**Las asas de la olla están diseñadas para una fijación segura**  
**Sistema de bloqueo para evitar que la olla coja presión en caso de mal acople**  
**Ventana de salida de vapor en la tapa, en caso de fallo de los sistemas de seguridad, esta ventana permite la pérdida de presión**

Les poignées de l'autocuiseur sont conçues pour une fixation sûre  
 Système de blocage pour éviter que la cocotte se remplisse de pression en cas de mauvais ajustement  
 Fenêtre de sortie de vapeur sur le couvercle. En cas de dysfonctionnement des systèmes de sécurité, cette fenêtre permet d'évacuer la pression

Die Griffe Schnellkochtöpfe sind für einen festen Verschluss ausgelegt  
 Blockiersystem zur Vermeidung des Druckaufbaus bei nicht korrekt aufgesetztem Deckel  
 Dampfaustrittsfenster, falls die Sicherheitsvorrichtungen ausfallen, kann der Dampf über dieses Fenster entweichen

The handles of the cooker are designed with safety interlock  
 Locking system to prevent the cooker from gaining pressure if it has not been properly closed  
 Steam output window in the lid; in the event that the security systems fail, this window enables pressure to be released

As asas da panela foram desenhadas com uma fixação segura  
 Sistema de bloqueio, que evita que a panela acumule pressão se estiver mal fechada  
 Janela de saída de vapor na tampa: em caso de falha dos sistemas de segurança, permite a saída da pressão



### Olla a presión

Cocotte à pression  
 Schnellkochtopf  
 Pressure cooker  
 Panela de pressão

Ref	€	Ø (cm)	h (cm)	L	Pack
71815	366,80	28	25,0	15,0	1
71821	381,00	28	33,0	20,0	1

## Robust



**Fabricada en aluminio de máxima calidad (grado de pureza 99,55)**  
**Diseño elegante, selecto, de gran durabilidad. Triple sistema de seguridad**  
**Ahorro de tiempo y energía (Reduce los tiempos de cocción hasta un 70%)**

Il est conçu en aluminium haute qualité (degré de pureté de 99,5 %)  
 Design élégant, sélect, d'une grande durabilité. Triple système de sécurité  
 Gain de temps et économie d'énergie (réduit les durées de cuisson jusqu'à 70%)

Aus hochwertigem Aluminium (mit einem Reinheitsgrad von 99,5 %) gefertigt  
 Elegantes, ausgesuchtes Design und äußerst robust. Dreifaches Sicherheitssystem  
 Zeit- und Energieersparnis (die Garzeiten werden um bis zu 70% reduziert)

Made of high quality aluminium (with a 99.5% degree of purity)  
 Elegant, exclusive and highly durable design. Triple safety system  
 Time and energy saving (Reduces cooking times by up to 70%)

Fabricada em alumínio da máxima qualidade, (grau de pureza é de 99,5 %)  
 Design elegante e exclusivo, de grande durabilidade. Triplo sistema de segurança  
 Poupa tempo e energia (reduz os tempos de cocção até 70%)



### Olla a presión

Cocotte à pression  
 Schnellkochtopf  
 Pressure cooker  
 Panela de pressão

Ref	€	Ø (cm)	h (cm)	L	Pack
20830	1.066,10	42	31	30	1
20840	1.148,10	42	39	40	1
20850	1.219,90	42	46	50	1

## Pro-Classic



**Para uso profesional**  
**Fabricado en aluminio puro**  
**Ahorro de tiempo y energía (70%) con máximo aprovechamiento de los nutrientes y vitaminas**

À usage professionnel  
 Fabriqué en aluminium pur  
 Gain de temps et économie d'énergie (réduit les durées de cuisson jusqu'à 70%)

Für den gewerblichen Gebrauch  
 Reines Aluminium  
 Zeit- und Energieersparnis (die Garzeiten werden um bis zu 70% reduziert)

For professional use  
 Manufactured in pure aluminium  
 Time and energy saving (Reduces cooking times by up to 70%)

Para uso profissional  
 Fabricado em alumínio puro  
 Poupa tempo e energia (reduz os tempos de cocção até 70%)



### Olla a presión

Cocotte à pression  
 Schnellkochtopf  
 Pressure cooker  
 Panela de pressão

Ref	€	Ø (cm)	h (cm)	L	Pack
20518	118,80	32	23,0	18,0	1
20522	132,00	34	23,0	22,0	1

## Aluminio



**Para uso profesional. Fabricado en aluminio puro**  
**Ahorro de tiempo y energía (70%) con máximo aprovechamiento de los nutrientes y vitaminas**

À usage professionnel. Fabriqué en aluminium pur  
 Gain de temps et économie d'énergie (réduit les durées de cuisson jusqu'à 70%)

Für den gewerblichen Gebrauch  
 Reines Aluminium  
 Zeit- und Energieersparnis (die Garzeiten werden um bis zu 70% reduziert)

For professional use. Manufactured in pure aluminium  
 Time and energy saving (Reduces cooking times by up to 70%)

Para uso profissional. Fabricado em alumínio puro  
 Poupa tempo e energia (reduz os tempos de cocção até 70%)



### Olla a presión

Cocotte à pression  
 Schnellkochtopf  
 Pressure cooker  
 Panela de pressão

Ref	€	Ø (cm)	h (cm)	L	Pack
20615	162,30	27	27,5	15,0	1
20618	173,10	27	32,5	18,0	1

## Tempo



**Ahorro de tiempo y energía (Reduce los tiempos de cocción hasta un 70%)**  
 Gain de temps et économie d'énergie (réduit les durées de cuisson jusqu'à 70%)  
 Zeit- und Energieersparnis (die Garzeiten werden um bis zu 70% reduziert)  
 Time and energy saving (Reduces cooking times by up to 70%)  
 Poupa tempo e energia (reduz os tempos de cocção até 70%)



### Olla a presión

Cocotte à pression  
 Schnellkochtopf  
 Pressure cooker  
 Panela de pressão

Ref	€	Ø (cm)	h (cm)	L	Pack
71864	69,10	22	12,0	4,0	1
71866	71,10	22	16,0	6,0	1
71868	76,40	22	19,5	8,0	1



### Set de ollas a presión 6-4 L

Ensemble de cocottes à pression 6-4 L  
 Schnellkochtopf-Satz, 6-4 L  
 Set of 6-4 L pressure cooker  
 Conj. de panelas de pressão 6-4 L

Ref	€	Ø (cm)	h (cm)	L	Pack
71862	108,40	22	16,0	6,0	1
		22	12,0	4,0	

## Classic



**Ahorro de tiempo y energía (Reduce los tiempos de cocción hasta un 70%)**  
 \* Las referencias 71872-71875 contienen un cestillo

Gain de temps et économie d'énergie (réduit les durées de cuisson jusqu'à 70%)  
 \* Les références 71872-71875 contiennent un panier

Zeit- und Energieersparnis (die Garzeiten werden um bis zu 70% reduziert)  
 \* In den Artikeln 71872-71875 ist ein Korb im Lieferumfang enthalten

Time and energy saving (Reduces cooking times by up to 70%)  
 \* The 71872-71875 references contain a basket

Poupa tempo e energia (reduz os tempos de cocção até 70%)  
 \* As referências 71872-71875 incluem um cesto

### Olla a presión

Cocotte à pression  
 Schnellkochtopf  
 Pressure cooker  
 Panela de pressão

Ref	€	Ø (cm)	h (cm)	L	Pack
71874	80,60	22	11,5	4,0	1
71876	87,70	22	17,0	6,0	1
71878	95,90	24	19,0	8,0	1
71871	102,50	24	23,0	10,0	1
71872	151,50	26	23,0	12,0	1 *
71875	163,10	26	29,0	15,0	1 *







Sartenes  
FryPans

#CocinaConLacor



## Inox

### Diseñadas para los Chefs más exigentes

Gran resistencia y un rendimiento excelente en cocinas exigentes

Homogeneidad y eficacia térmica

Cocción ultra-rápida

Recubrimiento antiadherente TRlcapa Eclipse Plus, de gran calidad y ecológico

Libre de PFOA

Aptas para todo tipo de cocinas



Conçues pour les Chefs les plus exigeants

Grande résistance et excellent rendement dans les cuisines exigeantes

Homogénéité et efficacité thermique

Cuisson ultra-rapide

Revêtement antiadhésif Tri-couche, de grande qualité et écologique Eclipse Plus sans PFOA

Compatibles avec tout type de cuisinières

Sehr anspruchsvolle Küchenchefs

Hohe Beständigkeit und exzellente Leistung in anspruchsvollen Küchen

Gleichförmigkeit und thermische Effektivität

Ultraschnelles Garen

Qualitätsvolle und umweltfreundliche Antihafbeschichtung TRlcapa Eclipse Plus ohne PFOA

Für alle Herdarten mit Ausnahme

Designed for the most demanding Chefs

Great resistance and excellent performance in demanding kitchens

Thermal homogeneity and efficiency

Ultra-rapid cooking

TRI-layer non-stick coating, high quality and eco-friendly Eclipse Plus, PFOA-free

Suitable for all types of cooking surfaces

Pensadas para os Chefs mais exigentes

Grande resistência e um rendimento excelente em cozinhas exigentes

Homogeneidade e eficácia térmica

Cocção ultra-rápida

Revestimento antiaderente TRlcapa, de grande qualidade e ecológico Eclipse Plus, sem PFOA

Aptas para todo o tipo de fogões

### Sartén Chef-Inox

Poêle Chef-Inox

Pfanne Chef-Inox

Frying-pan Chef-Inox

Sertã Chef-Inox

Ref	€	Ø (cm)	h (cm)	e (mm)	Pack
51620	33,00	20	4,0	1,0	1
51624	36,30	24	4,5	1,0	1
51628	44,10	28	5,5	1,0	1
51632	52,80	32	6,0	1,0	1
51636	66,10	36	6,5	1,0	1
51640	79,20	40	6,5	1,0	1

### Sartén Chef-Inox Plus

Poêle Chef-Inox Plus

Pfanne Chef-Inox Plus

Frying-pan Chef-Inox Plus

Sertã Chef-Inox Plus



Ref	€	Ø (cm)	h (cm)	e (mm)	Pack
51621	40,40	20	4,0	1,0	1
51625	45,30	24	4,5	1,0	1
51629	54,60	28	5,5	1,0	1
51633	67,80	32	6,0	1,0	1
51637	87,80	36	6,5	1,0	1
51641	102,30	40	6,5	1,0	1

Acabado cerámico  
Ceramic finished



### Sartén Chef-Inox Ceram

Poêle Chef-Inox Ceram

Pfanne Chef-Inox Ceram

Frying-pan Chef-Inox Ceram

Sertã Chef-Inox Ceram

Ref	€	Ø (cm)	h (cm)	e (mm)	Pack
51720	41,90	20	4,0	1,0	1
51724	47,40	24	4,5	1,0	1
51728	57,30	28	5,5	1,0	1
51732	71,50	32	6,0	1,0	1
51736	88,50	36	6,5	1,0	1
51740	103,70	40	6,5	1,0	1

### Sartén Vitrocor

Poêle

Pfanne

Frying pan

Sertã



Ref	€	Ø (cm)	h (cm)	e (mm)	Pack
40619	26,00	18	4,5	0,7	1
40621	27,60	20	4,5	0,7	1
40623	29,10	22	5,0	0,7	1
40625	30,70	24	5,2	0,7	1
40627	31,60	26	6,0	0,7	1
40629	34,00	28	6,5	0,7	1

## Aluminio Inducción

Diseñadas para los Chefs más exigentes

Garantiza una cocción uniforme de los alimentos además de un ahorro importante en el uso de energía necesaria

Recubrimiento antiadherente TRICapa Eclipse Plus, de gran calidad y ecológico Libre de PFOA

Ideales para un uso intensivo

Ligeras, manejables y fáciles de limpiar

Aptas para todo tipo de cocinas

Conçues pour les Chefs les plus exigeants

Garantit une cuisson uniforme des aliments ainsi qu'une importante économie de l'utilisation de l'énergie nécessaire.

Revêtement antiadhésif Tri-couche, de grande qualité et écologique Eclipse Plus sans PFOA

Idéales pour un usage intensif

Légères, maniables et faciles à nettoyer

Compatibles avec tout type de cuisinières

Sehr anspruchsvolle Küchenchefs

Garantiert gleichmäßigen Kochvorgang und wirkt energiesparend

Qualitätsvolle und umweltfreundliche Antihaftbeschichtung TRICapa Eclipse Plus ohne PFOA

Ideal für dauernden Einsatz

Leicht, handlich und einfach zu reinigen

Für alle Herdarten mit Ausnahme

Designed for the most demanding Chefs

It guarantees uniform cooking of the food, besides strong savings in the use of the necessary energy

TRI-layer non-stick coating, high quality and eco-friendly Eclipse Plus, PFOA-free

Ideal for an intensive use

Light, easy handling and easy to clean

Suitable for all types of cooking surfaces

Pensadas para os Chefs mais exigentes

Cocção uniforme dos alimentos, com uma significativa poupança de energia

Revestimento antiaderente TRICapa, de grande qualidade e ecológico Eclipse Plus, sem PFOA

Pensadas para um uso intensivo

Leves, fáceis de manipular e de limpar

Aptas para todo o tipo de fogões

### Sartén Tricapa Plus con fondo

Poêle Tricapa Plus avec fond

Pfanne Tricapa Plus mit Boden

Frying-pan Tricapa Plus with botton

Sertã Tricapa Plus com fundo



Ref	€	Ø (cm)	h (cm)	e (mm)	Pack
21718	22,40	18	3,8	2,5	1
21720	25,50	20	4,0	3,5	1
21722	27,00	22	4,0	3,5	1
21724	29,60	24	4,5	3,5	1
21726	34,50	26	4,5	4,0	1
21728	37,30	28	4,5	4,0	1
21732	43,50	32	4,7	4,0	1
21736	53,10	36	5,5	4,0	1



Acabado cerámico  
Ceramic finished



### Sartén Eco-Chef con fondo

Poêle Eco-Chef avec fond

Pfanne Eco-Chef mit Boden

Frying-pan Eco-Chef with botton

Sertã Eco-Chef com fundo

Ref	€	Ø (cm)	h (cm)	e (mm)	Pack
22718	23,90	18	3,8	2,5	1
22720	27,30	20	4,0	3,5	1
22722	29,70	22	4,0	3,5	1
22724	32,00	24	4,5	3,5	1
22726	36,20	26	4,5	4,0	1
22728	40,30	28	4,5	4,0	1
22732	47,20	32	4,7	4,0	1
22736	55,60	36	5,5	4,0	1



## Aluminio



### Sartén Chef-Tricapa

Poêle Chef tri capa.  
Pfanne Chef, Tri Capa  
Frying pan Chef tri capa  
Sertã Chef Tri-capa



**Sartenes fabricadas en aluminio de máxima calidad diseñadas para uso profesional**  
**Óptima distribución de calor conservando las propiedades nutritivas de los alimentos y con un mínimo gasto de aceite y energía**  
**Recubrimiento antiadherente Multi-capa ecológico y libre de PFOA**  
**Ideales para un uso continuo**  
**Ligeras, manejables y fáciles de limpiar**  
**Aptas para todo tipo de cocinas, excepto inducción**

Poêles fabriquées en aluminium de grande qualité conçues pour un usage professionnel

Distribution optimale de la chaleur en conservant les propriétés nutritives des aliments et avec une utilisation d'huile et d'énergie minimales  
Revêtement antiadhésif multicouches écologique et sans PFOA  
Idéales pour un usage continu  
Légères, maniables et faciles à nettoyer  
Compatibles avec tout type de cuisinière, excepté l'induction

Pfannen aus qualitativem Aluminium für professionellen Gebrauch  
Optimale Wärmeverteilung bewahrt Nährwert der Speisen und verbraucht wenig Energie und Öl  
Umweltfreundliche mehrlagige Antihafbeschichtung ohne PFOA  
Ideal für dauernden Einsatz. Leicht, handlich und einfach zu reinigen  
Für alle Herdarten mit Ausnahme von Induktion geeignet

Pans made in top quality aluminium and design for professional use  
Optimal heat distribution, preserving the nutritional properties and with a minimal waste of oil and energy  
Multi-layer eco-friendly non-stick coating, PFOA-free  
Ideal for continuous use. Light, easy handling and easy to clean  
Suitable for all types of cooking surfaces, except induction

Sertãs fabricadas em alumínio da máxima qualidade, pensadas para uso profissional  
Ótima distribuição do calor, conservando as propriedades nutritivas dos alimentos, e reduzindo ao mínimo o gasto de óleo e de energia  
Revestimento antiaderente Multicapa, ecológico e sem PFOA  
Ideais para um uso contínuo  
Leves, fáceis de manipular e de limpar  
Aptas para todo o tipo de fogões (exceto placas de indução)

Ref	€	Ø (cm)	h (cm)	e (mm)	Pack
21618	20,80	18	3,8	2,5	1
21620	22,80	20	4,0	3,5	1
21622	24,90	22	4,0	3,5	1
21624	27,50	24	4,5	3,5	1
21626	30,40	26	4,5	4,0	1
21628	34,70	28	4,5	4,0	1
21632	41,00	32	4,7	4,0	1
21636	48,80	36	5,5	4,0	1
21640	56,50	40	5,5	4,0	1



**New**



### Sartén DYNAMIC

Poêler  
Eisen-Pfanne  
Frying-pan  
Sertã



Pans made in top quality aluminium and design for professional use  
Optimal heat distribution, preserving the nutritional properties and with a minimal waste of oil and energy  
Multi-layer eco-friendly non-stick coating, PFOA-free  
Ideal for continuous use. Light, easy handling and easy to clean  
Suitable for all types of cooking surfaces, except induction

Sertãs fabricadas em alumínio da máxima qualidade, pensadas para uso profissional  
Ótima distribuição do calor, conservando as propriedades nutritivas dos alimentos, e reduzindo ao mínimo o gasto de óleo e de energia  
Revestimento antiaderente Multicapa, ecológico e sem PFOA  
Ideais para um uso contínuo  
Leves, fáceis de manipular e de limpar  
Aptas para todo o tipo de fogões (exceto placas de indução)

Ref	€	Ø (cm)	h (cm)	e (mm)	Pack
23416	11,50	16	3,5	2,5	1
23418	12,40	18	3,5	2,5	1
23420	14,30	20	4,0	3,5	1
23422	16,70	22	4,0	3,5	1
23424	18,50	24	4,5	3,5	1
23426	23,50	28	4,5	4,0	1
23428	24,10	28	4,5	4,0	1
23432	29,50	32	4,7	4,0	1
23436	37,30	36	5,5	4,0	1

### Sartén Robust Aluminio

Poêle Robust aluminium  
Pfanne Robust, Aluminium  
Frying-pan Robust aluminium  
Sertã Robust Alumínio



### Sartén Robust Plus Aluminio

Poêle Robust aluminium  
Pfanne Robust, Aluminium  
Frying-pan Robust aluminium  
Sertã Robust Plus Alumínio



Ref	€	Ø (cm)	h (cm)	e (mm)	Pack
23616	11,60	16	3,5	2,5	1
23618	12,50	18	3,5	2,5	1
23620	14,80	20	4,0	3,5	1
23622	17,00	22	4,0	3,5	1
23624	18,90	24	4,5	3,5	1
23626	22,80	26	4,5	4,0	1
23628	24,50	28	4,5	4,0	1
23632	29,90	32	4,7	4,0	1
23636	38,50	36	5,5	4,0	1
23640	45,70	40	5,5	4,0	1

Ref	€	Ø (cm)	h (cm)	e (mm)	Pack
23816	13,00	16	3,5	2,5	1
23818	13,80	18	3,5	2,5	1
23820	16,80	20	4,0	3,5	1
23822	18,50	22	4,0	3,5	1
23824	21,00	24	4,5	3,5	1
23826	24,00	26	4,5	4,0	1
23828	28,00	28	4,5	4,0	1
23832	32,70	32	4,7	4,0	1
23836	39,80	36	5,5	4,0	1
23840	48,70	40	5,5	4,0	1

## Hierro

### Sartén FERRUM

Poêle r  
Eisen-Pfanne  
Frying-pan I  
Sertã



Ref	€	Ø (cm)	h (cm)	e (mm)	Pack
63620	18,10	20	3,5	2,5	1
63624	21,00	24	4,5	2,5	1
63626	22,50	26	4,5	2,5	1
63628	23,80	28	5,0	2,5	1
63632	28,00	32	5,3	2,5	1
63636	35,90	36	5,5	2,5	1
63640	39,70	40	5,8	2,5	1

**New**

### SIN ANTIADHERENTE / WITHOUT NON-STICK COATING

**Disfruta de una sartén para toda la vida**  
**Fabricadas artesanalmente con 100% hierro natural**  
**Calidad Premium; duraderas y resistentes a arañazos**  
**Especial para cocciones a alta temperatura**  
**Espesor 2,5mm. Fácil limpieza. Cocina ecológica, cocina saludable**

Une poêle qui vous durera toute la vie  
Fabriquées de façon artisanale avec 100% de métal naturel  
Qualité Premium; durables et résistantes aux rayures  
Spéciales pour des cuissons à haute température  
Épaisseur 2,5mm. Nettoyage facile. Cuisine écologique, cuisine saine

Profitiere von einer Pfanne fürs ganze Leben  
Von Hand aus 100% natürlichem Eisen hergestellt  
Premiumqualität - langlebig und kratzfest  
Ideal für Kochen bei hohen Temperaturen  
2,5 mm dick. Einfach zu reinigen. Umweltfreundliche und gesunde Küche

Enjoy this one pan your whole life  
Hand-made in 100% natural iron  
Premium Quality; long lasting and resistant to scratching  
Specially for cooking at high temperatures  
2.5mm thickness. Easy to clean. Eco-friendly, healthy kitchen

Desfrute de uma sertã para toda a vida  
Fabricadas artesanalmente, 100% ferro natural  
Qualidade Premium, de longa duração e resistentes aos riscos  
Especial para cocções a alta temperatura  
Espessura de 2,5 mm. Fácil limpeza. Cozinha ecológica, cozinha saudável

### CON ANTIADHERENTE / WITH NON-STICK COATING

**Disfruta de una sartén para toda la vida**  
**Fabricadas artesanalmente con 100% hierro natural.**  
**Alta conductividad térmica. El hierro al ser un excelente conductor del calor, permite conseguir y mantener la temperatura ideal de cocción con un menor consumo energético**  
**Antiadherente premium, libre de PFOA**  
**Calidad Premium; duraderas y resistentes a arañazos**  
**Espesor 2,5mm. Fácil limpieza**

Une poêle qui vous durera toute la vie  
Fabriquées de façon artisanale avec 100% de métal naturel  
Haute conductivité thermique. Le métal, excellent conducteur de chaleur, permet d'obtenir et de maintenir la température de cuisson idéale avec une consommation d'énergie moins importante  
Antiadhésif premium, sans PFOA  
Qualité Premium; durables et résistantes aux rayures  
Épaisseur 2,5mm. Facile à nettoyer

Profitiere von einer Pfanne fürs ganze Leben  
Von Hand aus 100% natürlichem Eisen hergestellt  
Hohe Wärmeleitfähigkeit Sehr stark wärmeleitendes Eisen sorgt für anhaltend ideale Kochtemperatur bei geringerem Energieverbrauch  
Antihaft Premium ohne PFAO  
Premiumqualität - langlebig und kratzfest  
2,5 mm dick. Einfach zu reinigen

Enjoy this one pan your whole life  
Hand-made in 100% natural iron  
High heat conduction. Iron is an excellent conductor of heat, allowing you to obtain and maintain the ideal temperature with less energy consumption  
Premium non-stick, PFOA free  
Premium Quality; long lasting and resistant to scratching  
2.5mm thickness. Easy to clean

Desfrute de uma sertã para toda a vida.  
Fabricadas artesanalmente, 100% ferro natural  
Alta condutividade térmica. Ao ser um excelente condutor do calor, o ferro permite alcançar e manter a temperatura ideal de cocção com um menor consumo energético  
Antiaderente Premium, sem PFOA  
Qualidade Premium, de longa duração e resistentes aos riscos  
Espessura de 2,5 mm. Fácil limpeza

### Sartén FERRUM antiadherente

Poêle antiadherent  
Eisen-Pfanne, Antihaft  
Frying-pan, non-stick  
Sertã anti-aderente



Ref	€	Ø (cm)	h (cm)	e (mm)	Pack
63720	20,80	20	3,5	2,5	1
63724	22,80	24	4,5	2,5	1
63726	24,50	26	4,5	2,5	1
63728	25,80	28	5,0	2,5	1
63732	29,90	32	5,3	2,5	1
63736	37,20	36	5,5	2,5	1
63740	42,60	40	5,8	2,5	1

**New**



## Sartén Blinis



### Sartén "Blinis" Robust Aluminium

Poêle "Blinis" Robust aluminium  
Pfanne "Blinis" Robust, Aluminium  
Frying-pan "Blinis" Robust aluminium  
Sertã "Blinis" Robust Aluminium



Ref	€	Ø (cm)	h (cm)	e (mm)	Pack
23612	8,70	12	2,1	2,5	6
23614	10,20	14	2,2	2,5	6

**New**

### Sartén Blinis FERRUM

Poêle Blinis  
Blinis Pfanne  
Blinis frying pan  
Sertã Blinis



Ref	€	Ø (cm)	h (cm)	e (mm)	Pack
63613	15,50	12	2,1	2,0	6
63614	17,20	14	2,2	2,0	6

### Sartén Blinis FERRUM antiadherente

Poêle Blinis antiadherent  
Blinis Pfanne, Antihaft  
Blinis frying pan, Non-stick  
Sertã Blinis anti-aderente



Ref	€	Ø (cm)	h (cm)	e (mm)	Pack
63712	16,10	12	2,1	2,0	6
63714	17,40	14	2,2	2,0	6

## Woks

**New**



### Wok Robust Aluminium

Wok Robust aluminium  
Wok Robust, Aluminium  
Robust wok aluminium  
WokRobust Aluminium



Ref	€	Ø (cm)	h (cm)	e (mm)	Pack
23830	34,50	30	7,0	4,0	1

### Wok FERRUM

Wok  
Wok  
Wok  
Wok



Ref	€	Ø (cm)	h (cm)	e (mm)	Pack
63828	30,40	28	8,0	2,0	1

**New**

### Wok antiadherente

Wok, Antiadherent  
Wok, Antihaft  
Wok, Non-stick  
Wok anti-aderente



Ref	€	Ø (cm)	h (cm)	e (mm)	Pack
63729	21,90	28	8,5	0,9	1

### Wok antiadherente FERRUM

Wok, Antiadherent  
Wok, Antihalt  
Wok, non-stick  
Wok anti-aderente



Ref	€	Ø (cm)	h (cm)	e (mm)	Pack
63829	31,60	28	8,0	2,0	1

## Asadoras

**New**

### Asador FERRUM

Rôtissoire  
Grillspieß  
Rotisserie  
Grelhador



Ref	€	Ø (cm)	h (cm)	e (mm)	Pack
63725	23,10	26	3,0	2,5	1

**New**

### Asador FERRUM antiadherente

Rôtissoire, antiadherent  
Grillspieß, Antihaf  
Non-stick rotisserie  
Grelhador anti-aderente



Ref	€	Ø (cm)	h (cm)	e (mm)	Pack
63727	23,60	26	3,0	2,5	1

## Creperas



### Crepera Robust Aluminio

Crepiera Robust aluminium  
Crêpes Pfanne, Aluminium  
Crepiera Robust aluminium  
Crepeira Robust Alumínio



Ref	€	Ø (cm)	h (cm)	e (mm)	Pack
23322	14,00	22	1,8	2,5	1
23326	17,30	26	1,8	2,7	1
23330	25,10	30	2,2	4,0	1

### Crepera FERRUM antiadherente

Crepiera, antiadherent  
Crêpes-Pfanne, Antihaf  
Crepiera, Non-stick  
Crepeira anti-aderente



Ref	€	Ø (cm)	h (cm)	e (mm)	Pack
23323	16,40	22	1,8	2,5	1
23327	18,70	26	2,2	2,5	1

## Sartén Oval · Rectangular



### Sartén Oval Robust Aluminio

Poêle oval Robust aluminium  
Pfanne Robust, oval, Aluminium  
Oval frying-pan robust aluminium  
Sertã oval Robust Alumínio



Ref	€	cm	h (cm)	e (mm)	Pack
23637	47,90	36x26	5,0	2,7	1
23641	49,80	40x29	5,5	2,7	1

### Sartén Rectangular Robust Alum.

Poêle rectangulière Robust alum.  
Pfanne Robust, rechteckig  
Rectangular frying-pan Robust alum  
Sertã rectangular Robust Alum.



Ref	€	cm	h (cm)	e (mm)	Pack
23638	41,50	38x26	5,0	4,0	1

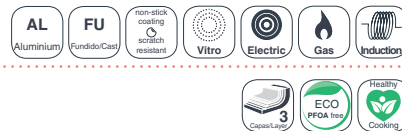

• **Doméstico** •

## Eco-Piedra Black

### Sartén

Poêle  
Pfanne  
Frying pan  
Sertã



Ref	€	Ø (cm)	e (mm)	Pack
24120	24,70	20	4,0	1
24122	26,40	22	4,0	1
24124	28,50	24	4,0	1
24126	31,90	26	4,0	1
24128	33,80	28	4,0	1

Fabricadas en aluminio fundido de gran calidad y espesor, están reforzada con un acabado en piedra que le da la posibilidad de cocinar con menos aceite sin comprometer la salud y aprovechando una mayor durabilidad

La base de aluminio permite una distribución homogénea del calor, permitiendo que los alimentos se cocinen rápidamente y de manera uniforme, sin apenas utilizar aceite

Su antiadherente TRlcapa de máxima calidad y ecológico, es libre de PFOA Fácil limpieza interior y exterior gracias a protección antiadherente

Son aptas para todo tipo de fuegos y se puede lavar en el lavavajillas

\* Planchas: Incluyen asas ergonómicas extraíbles de silicona de alta resistencia (180°C) y termo aislantes

Fabriquées en fonte d'aluminium de grande qualité et épaisseur, elles sont renforcées par une finition en pierre qui leur confère la possibilité de cuisiner avec moins d'huile sans compromettre la santé, ainsi qu'une plus grande durabilité

La base en aluminium permet une distribution homogène de la chaleur, permettant aux aliments de se cuire rapidement et de façon uniforme, sans à peine utiliser d'huile Leur antiadhésif Tri-couche d'une qualité maximale et écologique, est sans PFOA. Intérieur et extérieur faciles à nettoyer grâce à la protection antiadhésive

Elles sont compatibles avec tout type de feux et peuvent être lavées au lave-vaisselle

\* Planchas : incluent des poignées ergonomiques extractibles en silicone d'une grande résistance (180°C) et thermo-isolantes

Aus besonders dickem und qualitativem Aluminium gegossen und mit Steinbeschichtung für ölsparendes Kochen ohne Gefahr für die Gesundheit und mit längerer Haltbarkeit

Aluminiumgrundlage sorgt für gleichmäßige Wärmeverteilung um Lebensmittel schnell und gleichmäßig und ohne viel Öl zu kochen Umweltfreundliche und qualitätsvolle Antihafbeschichtung TRlcapa ohne PFOA

Innen und außen einfach zu reinigen, dank Antihafbeschichtung

Für alle Herdarten geeignet und Waschmaschinen tauglich

\* Bleche: Inkl. ergonomischer und ausziehbarer Silikongriffe mit hoher Hitzebeständigkeit (180°C) und Wärmeisolierung

Made in high quality and thickness cast aluminium, it is reinforced with a stone coating allowing you to cook with less oil, without compromising your health and making it longer lasting

The aluminium base allows for a homogeneous heat distribution, allowing the food to cook quickly and uniformly, without barely any oil

Its high quality and eco-friendly non-stick coating TRlcapa is PFOA-free

Easy to clean interior and exterior with its non-stick protection

They are suitable for all range cookers and they are dishwasher safe

\* Skillets: These include removable, ergonomic silicon handles of high resistance (180°C) and heat insulators

Fabricadas em alumínio fundido de grande qualidade e espessura, reforçadas com um acabamento em pedra, que permite cozinhar com menos óleo sem comprometer a saúde, e proporciona uma maior durabilidade

A base de alumínio permite uma distribuição homogénea do calor, e uma cocção mais rápida de uniforme dos alimentos, com uma quantidade mínima de óleo

Revestimento antiaderente TRlcapa de máxima qualidade e ecológico, sem PFOA

Fácil limpeza interior e exterior graças à sua proteção antiaderente

Aptas para todo o tipo de fogões, e para máquinas de lavar louça

\* As placas para grelhar incluem asas ergonómicas extraíveis de silicone de alta resistência (180 °C) e termo-isolantes

### Grill liso

Grill lisse  
Grill Induktionfähig  
Grill flat  
Grelhador liso



Ref	€	cm	e (mm)	Pack
24123	29,40	24x24	4,0	1
24127	35,30	28x28	4,0	1

Aus besonders dickem und qualitativem Aluminium gegossen und mit Steinbeschichtung für ölsparendes Kochen ohne Gefahr für die Gesundheit und mit längerer Haltbarkeit

Aluminiumgrundlage sorgt für gleichmäßige Wärmeverteilung um Lebensmittel schnell und gleichmäßig und ohne viel Öl zu kochen Umweltfreundliche und qualitätsvolle Antihafbeschichtung TRlcapa ohne PFOA

Innen und außen einfach zu reinigen, dank Antihafbeschichtung

Für alle Herdarten geeignet und Waschmaschinen tauglich

\* Bleche: Inkl. ergonomischer und ausziehbarer Silikongriffe mit hoher Hitzebeständigkeit (180°C) und Wärmeisolierung

Made in high quality and thickness cast aluminium, it is reinforced with a stone coating allowing you to cook with less oil, without compromising your health and making it longer lasting

The aluminium base allows for a homogeneous heat distribution, allowing the food to cook quickly and uniformly, without barely any oil

Its high quality and eco-friendly non-stick coating TRlcapa is PFOA-free

Easy to clean interior and exterior with its non-stick protection

They are suitable for all range cookers and they are dishwasher safe

\* Skillets: These include removable, ergonomic silicon handles of high resistance (180°C) and heat insulators

Fabricadas em alumínio fundido de grande qualidade e espessura, reforçadas com um acabamento em pedra, que permite cozinhar com menos óleo sem comprometer a saúde, e proporciona uma maior durabilidade

A base de alumínio permite uma distribuição homogénea do calor, e uma cocção mais rápida de uniforme dos alimentos, com uma quantidade mínima de óleo

Revestimento antiaderente TRlcapa de máxima qualidade e ecológico, sem PFOA

Fácil limpeza interior e exterior graças à sua proteção antiaderente

Aptas para todo o tipo de fogões, e para máquinas de lavar louça

\* As placas para grelhar incluem asas ergonómicas extraíveis de silicone de alta resistência (180 °C) e termo-isolantes

### Grill

Grill  
Grill Induktionfähig  
Grill  
Grelhador



Ref	€	cm	e (mm)	Pack
24125	29,50	24x24	4,0	1
24129	35,40	28x28	4,0	1

Aus besonders dickem und qualitativem Aluminium gegossen und mit Steinbeschichtung für ölsparendes Kochen ohne Gefahr für die Gesundheit und mit längerer Haltbarkeit

Aluminiumgrundlage sorgt für gleichmäßige Wärmeverteilung um Lebensmittel schnell und gleichmäßig und ohne viel Öl zu kochen Umweltfreundliche und qualitätsvolle Antihafbeschichtung TRlcapa ohne PFOA

Innen und außen einfach zu reinigen, dank Antihafbeschichtung

Für alle Herdarten geeignet und Waschmaschinen tauglich

\* Bleche: Inkl. ergonomischer und ausziehbarer Silikongriffe mit hoher Hitzebeständigkeit (180°C) und Wärmeisolierung

Made in high quality and thickness cast aluminium, it is reinforced with a stone coating allowing you to cook with less oil, without compromising your health and making it longer lasting

The aluminium base allows for a homogeneous heat distribution, allowing the food to cook quickly and uniformly, without barely any oil

Its high quality and eco-friendly non-stick coating TRlcapa is PFOA-free

Easy to clean interior and exterior with its non-stick protection

They are suitable for all range cookers and they are dishwasher safe

\* Skillets: These include removable, ergonomic silicon handles of high resistance (180°C) and heat insulators

Fabricadas em alumínio fundido de grande qualidade e espessura, reforçadas com um acabamento em pedra, que permite cozinhar com menos óleo sem comprometer a saúde, e proporciona uma maior durabilidade

A base de alumínio permite uma distribuição homogénea do calor, e uma cocção mais rápida de uniforme dos alimentos, com uma quantidade mínima de óleo

Revestimento antiaderente TRlcapa de máxima qualidade e ecológico, sem PFOA

Fácil limpeza interior e exterior graças à sua proteção antiaderente

Aptas para todo o tipo de fogões, e para máquinas de lavar louça

\* As placas para grelhar incluem asas ergonómicas extraíveis de silicone de alta resistência (180 °C) e termo-isolantes

### Crepera

Crépiere  
Crêpes Pfanne  
Crepiere  
Crepeira



Ref	€	Ø (cm)	h (cm)	e (mm)	Pack
24137	25,80	24	1,8	4,0	1
24136	28,50	26	1,8	4,0	1

### Wok

Wok  
Wok  
Wok  
Wok



Ref	€	Ø (cm)	h (cm)	e (mm)	Pack
24138	34,10	28	9,0	4,0	1

## Eco-Piedra Black



### Plancha Grill

Plaque à Grill  
Platte Grill  
Grill plaque  
Plancha Grill



Ref	€	Area cocción (cm)	h (cm)	e (mm)	Pack
24134	51,60	34x26	2,0	4,0	1



### Plancha Grill lisa

Plaque à Grill lisse  
Platte Grill, glatt  
Grill flat plaque  
Plancha Grill lisa



Ref	€	Area cocción (cm)	h (cm)	e (mm)	Pack
24135	53,60	34x26	2,0	4,0	1



### Plancha Grill

Plaque à Grill  
Platte Grill  
Grill plaque  
Plancha Grill



Ref	€	Area cocción (cm)	h (cm)	e (mm)	Pack
25536	29,60	29x22,5	1,5	4,0	1
25547	41,10	47x27	2,0	4,0	1



## Quantanium



### Sartén

Poêle  
Pfanne  
Frying pan  
Sertã

Ref	€	Ø (cm)	e (mm)	Pack
25120	24,30	20	4,0	1
25122	25,90	22	4,0	1
25124	27,80	24	4,0	1
25126	31,90	26	4,0	1
25128	35,00	28	4,0	1

Antiadherente reforzado con **Titanio**

## Quantanium®

Advanced **Titanium** reinforced nonstick

**Fabricadas en aluminio fundido de gran calidad y espesor**

**La base de aluminio permite una distribución homogénea del calor, permitiendo que los alimentos se cocinen rápidamente y de manera uniforme, sin apenas utilizar aceite**

**Antiadherente Quantanium, el primero y único antiadherente multi-capa con una mezcla de partículas de titanio. Libre de PFOA**

**Máxima resistencia al desgaste**

**Fácil limpieza interior y exterior gracias a su protección antiadherente**

**Son aptas para todo tipo de fuegos**

Fabriquéés en fonte d'aluminium de grande qualité et épaisseur.

La base en aluminium permet une distribution homogène de la chaleur permettant aux aliments de se cuire rapidement et de façon uniforme, sans à peine utiliser d'huile.

Antiadhésif Quantanium, le premier et unique antiadhésif multicouches avec un mélange de particules de titane. Sans PFOA.

Résistance maximale à l'usure

Intérieur et extérieur faciles à nettoyer grâce à la protection antiadhésive

Elles sont compatibles avec tout type de feux



### Grill liso

Grill lisse  
Grill Induktionfähig  
Grill flat  
Grelhador liso

Ref	€	cm	e (mm)	Pack
25523	30,80	24x24	4,0	1
25527	36,90	28x28	4,0	1

Aus besonders dickem und qualitativem Aluminium gegossen.

Aluminiumgrundlage sorgt für gleichmäßige Wärmeverteilung um Lebensmittel schnell und gleichmäßig und ohne viel Öl zu kochen.

Quantanium-Antihaf, die erste und einzige mehrlagige Antihafbeschichtung mit Titanbeimischung. Ohne PFOA

Sehr Verschleißfest

Innen und außen einfach zu reinigen, dank Antihafbeschichtung

Für alle Herdarten geeignet

Made in high quality and thickness cast aluminium

The aluminium base allows for a homogeneous heat distribution, allowing the food to cook quickly and uniformly, without barely any oil.

Quantanium Non-stick coating, the first and only multi-layered non-stick coating with a mix of titanium particles. PFOA-free.

High resistance to wear and tear

Easy to clean interior and exterior with its non-stick protection.

They are suitable for all range cookers



### Grill

Grill  
Grill Induktionfähig  
Grill  
Grelhador

Ref	€	cm	e (mm)	Pack
25525	30,80	24x24	4,0	1
25529	37,30	28x28	4,0	1

Fabricadas em alumínio fundido de grande qualidade e espessura.

A base de alumínio permite uma distribuição homogénea do calor, e uma cocção mais rápida de uniforme dos alimentos, com uma quantidade mínima de óleo

Antiaderente Quantanium: o primeiro e único antiaderente multicapa com uma mistura de partículas de titânio, sem PFOA.

Máxima resistência ao desgaste

Proteção antiaderente de fácil limpeza interior e exterior

Aptas para todo o tipo de fogões

## Stilo



### Sartén STILO

Poêle  
Pfanne  
Frying pan  
Sertã

Ref	€	Ø (cm)	h (cm)	Pack
27620	27,60	20	4,5	1
27624	31,40	24	5,2	1
27626	34,80	26	5,5	1
27628	37,60	28	6,0	1



### Grill STILO

Grill  
Grill Induktionfähig  
Grill  
Grelhador

Ref	€	cm	h (cm)	Pack
27625	34,50	24x24	4,8	1
27629	39,90	28x28	5,2	1

## Voga & Capri

### Sartén VOGA

Poêle  
Pfanne  
Frying-pan  
Sertã



Ref	€	Ø (cm)	h (cm)	e (mm)	Pack
24720	25,80	20	4,5	4,0	1
24722	28,10	22	5,0	4,0	1
24724	31,60	24	5,0	4,0	1
24726	34,90	26	5,5	4,0	1
24728	37,30	28	6,0	4,0	1
24732	42,60	32	6,5	4,0	1

### Sartén CAPRI

Poêle  
Pfanne  
Frying-pan  
Sertã



Ref	€	Ø (cm)	h (cm)	e (mm)	Pack
24820	17,10	20	4,5	4,0	1
24822	18,60	22	5,0	4,0	1
24824	20,50	24	5,0	4,0	1
24826	22,90	26	5,5	4,0	1
24828	24,70	28	6,0	4,0	1
24832	31,70	32	6,5	4,0	1

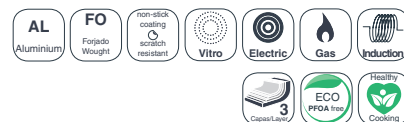

**Fabricado en aluminio forjado, acabado fuerte y robusto**  
**Calentamiento rápido y uniforme**

**24720-32 - Recubrimiento antiadherente ILAG:ULTIMATE (Tricapa) de gran calidad ultrasensible y de uso intensivo**  
**Mango de acero inoxidable, no se calienta**

**24820-32 - Recubrimiento antiadherente de calidad y larga duración**  
**Mango ergonómico en baquelita**

Fabriqué en aluminium forgé, finition solide et robuste  
Chauffe rapide et uniforme

24720-32 - Revêtement antiadhésif ILAG:ULTIMATE (tri-couche) de grande qualité ultra résistante et à usage intensif  
Manche en acier inoxydable, ne chauffe pas

24820-32 - Revêtement antiadhésif de grande qualité et longue durée  
Manche ergonomique en bakélite

Hergestellt aus geschmiedetem Aluminium, starke und robuste Verarbeitung  
Schnelle und gleichmäßige Erwärmung

24720-32 - Qualitativ hochwertige und widerstandsfähige Antihafbeschichtung ILAG:ULTIMATE (dreifach) für hohe Beanspruchung  
Edelstahlgriff wird nicht heiß

24820-32 - Antihafbeschichtung, Qualität und lange Lebensdauer  
Ergonomischer Griff aus Bakelit

Made of forged aluminium, strong and robust finish  
Quick and even heating

24720-32 - Ultra-resistant high-quality ILAG:ULTIMATE non-stick coating (Triple-layer) for intensive use. Heat-resistant stainless steel handle

24820-32 - Quality, long lasting non-stick coating  
Bakelite ergonomic handle

Fabricado em alumínio forjado, com um acabamento forte e robusto.  
Aquecimento rápido e uniforme

24720-32 - Revestimento antiaderente ILAG:ULTIMATE (Tricapa) de grande qualidade, ultra-resistente e de uso intensivo. Mango de aço inoxidável, que não aquece

24820-32 - Revestimento antiaderente de qualidade e de larga duração  
Mango ergonómico em baquelite

## Loft

### Sartén LOFT

Poêle  
Pfanne  
Frying-pan  
Sertã



Ref	€	Ø (cm)	h (cm)	e (mm)	Pack
24918	14,90	18	3,8	3,5	1
24920	16,40	20	4,3	3,5	1
24922	17,60	22	4,3	3,5	1
24924	19,80	24	4,8	3,5	1
24926	21,10	26	4,8	3,5	1
24928	24,30	28	5,3	3,5	1



**Fabricada en aluminio embutido, acabado fuerte y robusto**  
**Recubrimiento antiadherente. Calidad y larga duración**  
**Exterior en negro mate**  
**Calentamiento rápido y uniforme**  
**Mango SOFT TOUCH**

Fabriquée en aluminium embouti, finition forte et robuste.  
Revêtement antiadhésif. Qualité et longue durée de vie.

Extérieur en noir mat  
Chauffe rapide et uniforme  
Manche SOFT TOUCH

Aus gepresstem Aluminium mit gehärtetem und robustem Finish  
Antihafbeschichtung. Qualität und lange Haltbarkeit

Mattschwarzes Äußeres  
Gleichmäßige und schnelle Erwärmung  
SOFT TOUCH-Griff

Made from deep drawn aluminium, strong and robust finish  
Non-stick coating. Quality and long life

Outside in matte black  
Quick and uniform heating  
SOFT TOUCH handle

Fabricada em alumínio embutido, com acabamento forte e robusto  
Revestimento antiaderente, de qualidade e longa duração

Exterior em negro mate  
Aquecimento rápido e uniforme  
Mango SOFT TOUCH

## Home

**Sartén HOME Lisa**

Poêle Home, lisse  
Pfanne Home, glatt  
HomeFrying-pan flat  
Sertã Home Lisa



Ref	€	Ø (cm)	h (cm)	e (mm)	Pack
71318	30,60	18	5,5	0,7	1
71320	32,20	20	5,5	0,7	1
71322	35,90	22	5,5	0,7	1
71324	39,20	24	6,0	0,7	1
71326	43,10	26	6,0	0,7	1
71328	48,40	28	6,5	0,7	1

**Fabricadas en acero inoxidable 18/10 de máxima calidad**  
**Sartén con recubrimiento antiadherente TRlcapa Eclipse Plus de dureza extrema, libre de PFOA**  
**Su fondo difusor permite una cocina envolvente, rápida y eficaz**  
**Extremadamente resistentes**  
**Mango baquelita, aislante del calor y de excelente ergonomía**  
**Aptas para todo tipo de fuegos**

Fabriquées en acier inoxydable 18/10 de grande qualité  
Poêle dotée d'un revêtement antiadhésif Tri-couche Eclipse Plus d'une dureté extrême, sans PFOA.  
Leur fond diffuseur permet une cuisine à chaleur tournante, rapide et efficace.  
Extrêmement résistantes  
Manche en bakélite, isolant de la chaleur et doté d'une excellente ergonomie.  
Compatibles avec tout type de feux

Aus nicht rostendem Edelstahl 18/10  
Pfanne mit sehr harter Antihafbeschichtung TRlcapa Eclipse Plus ohne PFOA  
Wärmeleitender Boden sorgt für schnelles, wirkungsvolles und umhüllendes Kochen  
Sehr widerstandsfähig  
Sehr ergonomischer und wärmeabweisender Stiel aus Bakelit  
Für alle Herdarten geeignet

Made in high quality 18/10 stainless steel  
This pan with TRlcapa Eclipse Plus non-stick coating offers extreme hardness, and is PFOA-free.  
Its bottom diffuser allows for quick, effective, comprehensive cooking.  
Extremely resistant  
Bakelite handle, minimizing heat with excellent ergonomics  
Suitable for all types of cookers.

Fabricadas em aço inoxidável 18/10 de máxima qualidade  
Sertã com revestimento antiaderente TRlcapa Eclipse Plus de dureza extrema, sem PFOA  
Fundo difusor para uma cocção envolvente, rápida e eficaz  
Extremamente resistentes  
Mango de baquelite termo-isolante, de excelente ergonomia  
Aptas para todo tipo de fuegos

**Sartén HOME**

Poêle Home  
Pfanne Home  
Home Frying-pan  
Sertã Home



Ref	€	Ø (cm)	h (cm)	e (mm)	Pack
71818	30,60	18	5,5	0,7	1
71820	32,20	20	5,5	0,7	1
71822	35,90	22	5,5	0,7	1
71824	39,20	24	6,0	0,7	1
71826	43,10	26	6,0	0,7	1
71828	48,40	28	6,5	0,7	1

**Crepera MILAN**

Crêpiere  
Crêpes Pfanne  
Crepiere  
Crepeira



Ref	€	Ø (cm)	h (cm)	e (mm)	Pack
71726	43,80	26	2,0	0,7	1

## Trimetal



**TRImetal**  
• DESIGNED •



**Cuerpo fabricado en 3 capas: acero inoxidable 18/10, aluminio, acero inoxidable 18%  
El aluminio interior garantiza una cocción uniforme de los alimentos  
Además de un ahorro importante el en uso de energía necesaria  
La capa exterior, es de acero inoxidable con componentes ferríticos, lo que la  
convierte totalmente compatible con las cocinas de inducción  
Los mangos están fabricados en acero Inoxidable 18/10 y recubiertas  
con un protector térmico de silicona para facilitar un agarre perfecto y seguro**

Corps fabriqué avec 3 couches : acier inoxydable 18/10, aluminium, acier inoxydable 18%  
L'aluminium intérieur garantit une cuisson uniforme des aliments, ainsi qu'une  
importante économie de l'utilisation de l'énergie nécessaire  
La couche extérieure est en acier inoxydable avec des composants ferritiques, ce  
qui lui permet d'être totalement compatible avec les cuisinières à induction  
Les manches sont fabriqués en acier inoxydable 18/10 et recouverts  
d'une protection thermique en silicone pour faciliter une prise en main parfaite et  
sûre

Kessel aus dreilagigem Material: rostfreier Stahl 18/10, Aluminium, rostfreier Stahl 18%  
Zwischenlage aus Aluminium gewährleistet gleichmäßigen Kochvorgang und wirkt  
energiesparend  
Induktionsherdgeeignet dank Außenschicht aus rostfreiem Stahl mit ferritischen  
Bestandteilen Die Griffe und Stiele aus rostfreiem Stahl 18/10 und mit wärmeabwei-  
sender Silikonummantelung geben sicheren und perfekten Halt

Body manufactured in a 3-layered: 18/19 stainless steel, aluminium, 18% stainless steel  
The interior aluminium guarantees uniform cooking of the food  
Besides an important savings in the use of the necessary energy  
Exterior layer, of stainless steel with ferrite materials, making it completely compatible with  
induction cookers  
The grips are made in 18/10 stainless steel and covered in a silicon heat protection  
for easy and safe gripping

Corpo fabricado em 3 capas: aço inoxidável 18/10, alumínio, aço inoxidável 18%  
O interior de alumínio garante uma cocção uniforme dos alimentos, e uma grande  
poupança de energia  
Capa exterior de aço inoxidável com componentes ferríticos, totalmente compatível com as  
placas de indução  
Mangos fabricados em aço Inoxidável 18/10, revestidos com um protetor térmico  
de silicone para uma sujeição perfeita e segura

**Sartén**  
Poêle  
Pfanne  
Frying pan  
Sertã



Ref	€	Ø (cm)	h (cm)	e (mm)	Pack
53720	44,10	20	4,5	2,3	1
53724	49,10	24	5,0	2,3	1
53728	60,30	28	5,5	2,3	1

**Sartén antiadherente**  
Poêle antiadherent  
Pfanne, Antihalt  
Non-stick frying pan  
Sertã anti-aderente



Ref	€	Ø (cm)	h (cm)	e (mm)	Pack
53721	51,40	20	4,5	2,3	1
53725	61,50	24	5,0	2,3	1
53729	77,70	28	5,5	2,3	1

**New**

**Wok**  
Wok  
Wok  
Wok  
Wok



Ref	€	Ø (cm)	h (cm)	e (mm)	Pack
53828	66,80	28	8,0	2,3	1

**Wok antiadherente**  
Wok, Antiadherent  
Wok, Antihalt  
Wok, non-stick  
Wok anti-aderente



Ref	€	Ø (cm)	h (cm)	e (mm)	Pack
53829	74,30	28	8,0	2,3	1



## Tapas

### Tapa de cristal con desvaporizador

Couvercle en verre avec sortie de vapeur  
 Glasdeckel  
 Glass Lid with steam hole  
 Tampa de vidro con desvaporizador



Ref	€	Ø (cm)	Pack
71914	8,40	14	1
71916	8,60	16	1
71918	8,90	18	1
71920	9,60	20	1
71922	9,70	22	1
71924	10,10	24	1
71926	11,20	26	1
71928	11,70	28	1
71932	13,10	32	1

### Se adapta a todo tipo de baterías de cocina Vidrio térmico resistente a altas temperaturas Borde de acero inoxidable 18/10

S'adapte à tout type de batteries de cuisine  
 Verre thermique résistant aux hautes températures  
 Bord en acier inoxydable 18/10

Passend zu allen Arten von Küchenausstattung  
 Sehr hitzebeständiges Thermoglas  
 Rand aus nicht rostendem 18/10-Stahl

Fits all types of cookware  
 Tempered glass resistant to high temperatures  
 18/10 stainless steel rim

Adapta-se a todo o tipo de baterias de cozinha  
 Vidro térmico resistente a altas temperaturas  
 Rebordo em aço inoxidável 18/10

### Tapa

Couvercle  
 Deckel  
 Lid  
 Tampa



Ref	€	Ø (cm)	Pack
53916	15,90	16	1
53918	16,40	18	1
53920	17,10	20	1
53924	17,80	24	1

### Vidrio térmico resistente a altas temperaturas Borde de silicona para un mejor ajuste

Verre thermique résistant aux hautes températures  
 Bord en silicone pour un meilleur ajustement

Sehr hitzebeständiges Thermoglas  
 Silikonrand für bessere Passform

Tempered glass resistant to high temperatures  
 Silicone rim for a better fit

Vidro térmico resistente a altas temperaturas  
 Borda de silicone para um melhor ajuste



Ø20-Ø28



### Tapa aluminio antisalpicaduras Universal

Couvercle en aluminium anti-projections Universel  
 Universal-Anti Spritzschutz, Aluminium  
 Universal aluminium anti spalsh cover  
 Tampa alumínio anti respingo Universal

Ref	€	Ø (cm)	Pack
71931	13,60	20-28	12

### Acabado antiadherente y vidrio resistente al calor Asa resistente al calor Stay Cool

Finition antiadhésive et verre résistant à la chaleur  
 Pommeau résistant à la chaleur Stay Cool

Antihaftendes Finish und hitzebeständiges Glas  
 Hitzebeständiger Stay Cool Griff

Non-stick finish and heat-resistant glass  
 Stay Cool heat-resistant handle

Acabamento antiaderente e vidro resistente ao calor  
 Asa resistente ao calor Stay Cool



3 en 1



### Tapa antisalpicadura

Couvercle anti-projections  
 Anti Spritzschutz  
 Anti splash cover  
 Tampa anti respingo

Ref	€	Ø (cm)	Pack
71933	22,00	28	1

### Silicona resistente a altas temperaturas Tres artículos en uno: Tapa • Escurridor • Salvamanteles

Silicone résistante aux hautes températures  
 Trois articles en un : Couverture • Passoire • Dessous de plat

Sehr hitzebeständiges Silikon  
 Drei Artikel in einem: Deckel • Abtropfsieb • Untersetzer

Silicone resistant to high temperatures  
 Three items in one: Lid • Drainer • Table Mat

Silicone resistente a altas temperaturas  
 Três artigos num só: Tampa • Escorredor • Protetor de toalhas



Rustideras - Horno  
Roasting Pans - Oven

#CocinaConLacor

## Rustideras

Inox  
18/10

**Rustidera**  
Plat à rotir  
Lasagneform  
Roaster  
Assadeira



**Gran calidad, resistencia, tamaño y capacidad, muy útiles en la cocina**  
**Ideales para la cocción de platos y asados al horno**  
**Soportan sin problemas temperaturas muy altas**  
**Excelente resistencia a la corrosión y a los ácidos alimentarios y sales**  
**Asas atóxicas**

Grande qualité, robustesse, taille et capacité, très utiles dans la cuisine.  
Idéal pour la cuisson de plats et de rôtis au four  
Supporte sans problèmes des températures très élevées  
Excellente résistance à la corrosion et aux sels et acides alimentaires  
Poignées athermiques

Qualität, Widerstandsfähigkeit, Größe und Fassungsvermögen auf hohem Niveau.  
Ein sehr praktischer Küchenhelfer.  
Ideal für Gerichte und Braten aus dem Ofen  
Hält hohen Temperaturen problemlos stand  
Sehr korrosionsbeständig und widerstandsfähig gegen Säure aus  
Lebensmitteln und Salzen  
Hitzeabweisende Griffe

Great quality, durability, size and capacity, very useful in the kitchen  
Ideal for cooking dishes and roasts in the oven  
Easily withstands very high temperatures  
Excellent resistance to corrosion and to food acids and salts  
Heat-resistant handles

Ótima qualidade e resistência, grande tamanho e capacidade, muito útil na cozinha  
Ideais para a elaboração de pratos e de assados no forno  
Suportam temperaturas muito elevadas sem problemas  
Excelente resistência à corrosão e aos ácidos e sais alimentares  
Asas atóxicas

Ref	€	cm	h (cm)	Pack
62530	25,90	30x21	5,5	1
62535	34,20	35x26	5,5	1
62540	43,50	40x31	6,0	1

Inox  
18/10

**Rustidera**  
Plat à roir  
Bratpfanne  
Roaster  
Assadeira



Inox  
18%Cr

Ref	€	cm	h (cm)	Pack
50540	92,50	40x30	8,0	1
50550	122,50	50x40	8,0	1
50560	154,20	60x45	8,0	1
50570	176,20	70x45	9,5	1

**Rustidera asa abatible**  
Plat à gratin anse tombante  
Bratpfanne mit Fallgriffen  
Roaster moving handles  
Assadeira funda asa abatível



Ref	€	cm	h (cm)	Pack
61530	12,60	30x22	5,0	1
61535	15,90	35x26	5,3	1
61540	20,20	40x28	5,6	1
61545	29,40	45x32	7,5	1
61550	55,70	50x36	8,5	1



Inox  
18/10

**Rustidera Honda asa abatible**  
Plat á rotir anse tombante  
Bratpfanne mit Fallgriffen  
Roaster moving handles  
Assadeira funda asa abatível

Ref	€	cm	h (cm)	Pack
62530A	29,30	30x22	7,5	1
62535A	35,60	35x26	7,8	1
62540A	42,50	40x28	8,5	1
62545A	49,20	45x32	9,0	1

AL  
Aluminium

**Rustidera aluminio fundido inducción**  
Plat à gratin en aluminium fondu induction  
Bratpfanne Inductionnfähig, Aluminium  
Aluminium cast induction roaster  
Assadeira alumínio fundido inducción



**Tapa de cristal rustidera**  
Couvercle en verre pour plat à rôtir  
Deckel Glas für Bratpfanne  
Lid glass for roaster  
Tampa de vidro para assadeira

Ref	€	cm	Pack
25539	11,70	34x28x8	1



Ref	€	cm	h (cm)	Pack
25534	47,40	34x28	8	1





AL  
Aluminium

**Rustidera con asa abatible**  
Plat à rotir anse tombante  
Bratpfanne mit Fallgriffen  
Roaster moving handle  
Assadeira com asa abatível



Ref	€	cm	h (cm)	e (mm)	L	Pack
20540A	42,00	40x30	6,2	2,5	7,45	1
20545A	45,00	45x32	6,2	2,5	10,40	1
20550A	56,40	50x35	7,0	3,0	12,60	1
20555A	61,40	55x37	7,7	3,0	16,30	1
20560A	66,00	60x40	7,7	3,0	18,95	1
20565A	73,80	65x43	7,9	3,0	24,30	1
20570A	78,00	70x45	9,0	3,0	28,65	1

AL  
Aluminium

**Rustidera con asa fija**  
Plat à rotir anse fixe  
Bratpfanne  
Roaster fix handle  
Assadeira com asa fixa



Ref	€	cm	h (cm)	e (mm)	L	Pack
20540F	42,00	40x30	6,2	2,5	7,45	1
20545F	45,00	45x32	6,2	2,5	10,40	1
20550F	56,40	50x35	7,0	3,0	12,60	1
20555F	61,40	55x37	7,7	3,0	16,30	1
20560F	66,00	60x40	7,7	3,0	18,95	1
20565F	73,80	65x43	7,9	3,0	24,30	1
20570F	78,00	70x45	9,0	3,0	28,65	1

AL  
Aluminium

**Rustidera Robust c/asa abatible antiadherente**  
Plat à rotir Robust anse tombante, antiadherent  
Bratpfanne Robust mit Fallgriffen, Aluminium, Antihaf  
Roaster Robust moving handle, non-stick  
Assadeira Robust com asa abatível anti-aderente



Ref	€	cm	h (cm)	Pack
23540A	48,70	40x30	6,0	1
23550A	59,20	50x35	8,0	1

Inox  
18/10

**Parrilla**  
Grille  
Grillpfanne  
Grate  
Grelha



Ref	€	cm	h (cm)	Pack
68741	24,50	60x40	0,8	1



**Placa horno aluminio antiadherente**  
Plaque à four aluminium anti-adhésif teflon  
Backblech, Aluminium, Teflon  
Teflon non-stick coated oven aluminium tray  
Placa forno alumínio anti-aderente

Ref	€	cm	h (cm)	Pack
68660	28,80	60x40	1,0	1

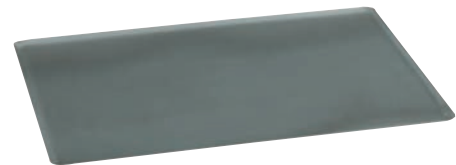

**Placa Horno acero negro**  
Plaque à four tole noire  
Backblech, Schwarzstahl  
Baking sheet black steel  
Placa de forno aço negro

Ref	€	cm	h (cm)	Pack
68640	29,60	60x40	0,8	1



**Placa Horno Inox 18%**  
Plaque à four en Inox 18%  
Backblech, Edelstahl 18%  
Baking sheet st steel 18%  
Placa de forno inóx 18%

Ref	€	cm	h (cm)	Pack
68740	35,10	60x40	0,8	1



**Placa Horno Aluminio**  
Plaque à four aluminium  
Backblech, Aluminium  
Baking sheet aluminium  
Placa de forno alumínio

Ref	€	cm	h (cm)	Pack
68641	27,40	60x40	0,8	1





**Fácil sistema de cierre y sujeción**  
Système simple de fermeture et de fixation  
Das leichte Verschluss- und Zusammenhaltssystem  
Easy to close and fasten  
Fácil sistema de fecho e fixação

230°C  
-40°C



**Para bridar, albardar, atar asados y rellenos**  
Pour ficeler, barder, attacher les rôtis et les aliments farcis  
Zum Binden, Umwickeln und Verschnüren von Braten und Füllungen  
For tying, wrapping and trussing roasts and stuffing  
Para embridar, envolver e atar assados e recheios

**Lazos de cocina**  
Lacets de cuisine  
Küchensilikonbänder  
Food loop  
Laços de cozinha



**Cordel cocina**  
Fil de cuisine  
Küche Zeichenkette  
Kitchen string  
Fio de cozinha



Ref	€	L (cm)	Pack
60448	4,30	54	6

Ref	€	m	Pack
61414	4,70	80	6

**Material: Rayón**  
Rayonne · Kunstseide · Rayon · Raiom

**Tapete de silicona**  
Tapis en silicone  
Backblech-Auflage Silikon  
Silicone covering  
Tapete de silicone



220°C  
Max.

**Flexible, antiadherente y reutilizable**  
Flexible, anti-adhérente et réutilisable  
Flexible, Antihaft- und wiederverwendbar  
Flexible, non-stick and reusable  
Flexível, antiaderente e reutilizável

Ref	€	cm	Pack
66749	16,40	30x40	1
66731	23,80	60x40	1
66732	17,60	52x32 GN 1/1	1

**New**

**Incluye - Includes:**  
1.- Tablas de conversión de temperatura (°C / °F)  
2.- Peso (gr / oz)  
3.- Volumen ml / floz / pt)  
4.- Longitud (mm / inch)  
5.- Reglas laterales (cm / inch)



**Tapete de silicona impreso**  
Tapis en silicone imprime  
Gedruckte Silikonmatte  
Printed silicon mat  
Tapete de silicone impresso

Ref	€	cm	Pack
66759	23,40	60x40	12



30 macarons -> 5cm  
48 macarons -> 4cm



**Molde macarons doble**  
moule macarons double  
Doppel Macaronsform  
Macarons dual mould  
Molde macarons duplo

Ref	€	cm	Pack
66753	8,70	39x29	6



**Permite hornear sin necesidad de utilizar papel de horno**  
Permet d'enfourner sans avoir à utiliser de papier sulfurisé  
Zum Backen ohne Backpapier  
Lets you bake without having to use oven paper  
Permite cozinhar no forno sem necessidade de utilizar papel de forno



**Láminas antiadherentes**  
Feuilles antiadhésif  
Antihaft-Blätter  
Non-stick sheets  
Lâminas antiaderentes

Ref	€	cm	unidades	Pack
66746	7,30	30x40	3	1

**New**



**Láminas de fibra de vidrio con recubrimiento antiadherente PTFE (Tefex) de gran calidad**  
Ideal para colocar sobre bandejas o parrillas de hornos y deshidratadores  
Vida útil aproximadamente de 1000 horneados  
Diseñadas para soportar temperaturas de hasta 250°C  
Recortable para adaptar a cualquier recipiente  
Reutilizables, para una correcta conservación se recomienda su lavado a mano  
No aptas para lavavajillas

Feuilles en fibre de verre avec revêtement antiadhésif PTFE (Teflex) de grande qualité  
Idéales pour poser sur des plaques ou des grilles de fours et déshydratants  
Durée de vie : environ 1 000 enfournages  
Conçues pour supporter des températures de jusqu'à 250°C  
Feuilles à découper adaptables à tout type de récipient  
Réutilisables ; pour une bonne conservation il est recommandé de les laver à la main  
Incompatibles avec le lave-vaisselle

Fibreglass sheets with non-stick coating high-quality PTFE (teflex)  
Ideal for placing on baking trays, oven racks and dehydrators  
Can be used approximately 1,000 times  
Designed to withstand temperatures up to 250°C  
Can be cut to fit any container  
Reusable; in order to keep the sheets in good condition, we recommend washing by hand  
Non-dishwasher safe

## Pinzas Horno



### Pinza para horno y bandeja GN

Pince inox pour bac Gastronorm  
Zange für GN Behälter  
Tong GN tray  
Pinça para forno e bandejas GN

Ref	€	L (cm)	Pack
62989	13,60	20	1



### Pinza con silicona para horno y bandeja

Pince Inox pour bac Gastronorm avec Silicone  
Zange für GN Behälter, mit Silikon  
Oven tray tong with Silicone  
Pinça para forno e bandejas com silicone

Ref	€	L (cm)	Pack
62998	13,70	20	12



### Pinza para platos calientes con silicona

Pince pour les plats chauds avec Silicone  
Zange für heisse Platten, mit Silikon  
Tong for hot plates with Silicone  
Pinça para pratos quentes com silicone

Ref	€	L (cm)	Pack
62999	13,70	19	12

## Reloj



### Reloj de cocina magnético

Minuteur de cuisine magnetique  
KMagnetküchentimer  
magnetic kitchen timer  
Relógio de cozinha magnetico



Ref	€	Tiempo	cm	Pack
60803	8,70	60 min.	9,2x3,5	12

Gracias a su parte posterior magnética podrá colocar el reloj de cocina en cualquier parte metálica de su cocina  
Alarma acústica programable

Grâce à sa partie arrière magnétique, le minuteur peut être placé sur n'importe quelle partie métallique de la cuisine  
Alarme acoustique programmable

Dank der magnetischen Rückseite kann die Küchenuhr an jede metalische Oberfläche in Ihrer Küche angebracht werden  
Programmierbarer akustischer alarm

Thanks to the magnet on the back, the kitchen timer can be placed on any metal surface in the kitchen  
Programmable acoustics alarm

Graças à sua parte posterior magnética, poderá colocar o relógio de cozinha em qualquer parte metálica da sua cozinha  
Alarme sonoro programável



Resistente al agua - Water resistance

### Reloj de cocina con alarma

Minuteur de Cuisine avec Alarme  
Küchen-Zeitschaltuhr mit Alarm  
Kitchen Timer Alarm  
Relógio de cozinha com alarme

Ref	€	cm	Pack
60804	30,20	13x24,5x2,5	1



### Reloj Digital de cocina con avisador acústico

Minuter Électronique  
Digitale Küchen-Zeitschaltuhr mit Alarm  
Digital kitchen timer w/alarm  
Relógio digital de cozinha com alarme acústico

Ref	€	cm
60805	7,00	10,5x7



## Guantes · Manoplas



**Materiales de alta calidad y una alta protección contra el calor**  
**Guante ambidiestro**  
**Manga que cubre la mayor parte del antebrazo**  
**Seguro y cómodo en el manejo de objetos calientes**

Matériaux de grande qualité et une haute protection contre la chaleur  
 Gant ambidextre  
 Manchette qui couvre la plus grande partie de l'avant-bras  
 Sûr et pratique pour la manipulation d'objets chaud

Hohe Materialqualität und Hitzeschutz  
 Beidhändiger Handschuh  
 Ärmel der fast den gesamten Unterarm bedeckt  
 Heiße Gegenstände sicher und bequem handhaben

High quality materials and excellent heat protection  
 Ambidextrous glove  
 Sleeve that covers most of the forearm  
 Safe and comfortable when handling hot objects

Materiais de alta qualidade, que proporcionam uma boa proteção contra o calor  
 Luva ambidextra  
 Manga que cobre a maior parte do antebraço  
 Cómoda e segura para a manipulação de objetos quentes

200°C  
Max.

200°C  
Max.

2  
Units



### Guante Universal algodón + silicona

Gant Universel en cotton + silicone  
 Universal-Küchenhandschuch, Silikon + Baumwolle  
 Cotton + silicone Universal glove  
 Luva Universal de algodão + silicone

Ref	€	cm	Pack
60062	26,70	32	1



2  
Units



### Guante Universal XL algodón + silicona

Gant Universel XL en cotton + silicone  
 Universal XL-Küchenhandschuch, Silikon + Baumwolle  
 Cotton + silicone Universal XL glove  
 Luva Universal XL de algodão + silicone

Ref	€	cm	Pack
60068	30,10	48	1



200°C  
Max.

200°C  
Max.

### Guante cocina textil + silicona

Gant de cuisine en cotton + silicone  
 Küchehandschuch aus Baumwolle + Silikon  
 Gray kitchen cotton + silicone  
 Luva de cozinha de algodão + silicone

Ref	€	cm	Pack
61034	7,80	32	12



### Guante cocina algodón + silicona

Gant de cuisine silicone  
 Küchehandschuh, Silikon + Baumwolle, grau  
 Gray kitchen silicone + cotton glove  
 Luva de cozinha de algodão + silicone

Ref	€	cm	Pack
61033	17,20	33	1





200°C  
Max.



**Propiedades autoextinguibles**

Propriétés arrêt automatiques  
Selbstlöschend Eigenschaften  
Self-extinguishing properties  
Propiedades auto-extinguível

300°C  
Max.

**Guante algodón aluminizado**

Gant de cuisine coton aluminisé  
Küchenhandschuh, Baumwolle, Aluminisierte  
Aluminized cotton oven glove  
Luva de cozinha de algodão alumínio

Ref	€	cm	Pack
61024	4,00	24	20
61030	4,80	30	20
61036	5,10	36	20



**Guante de cocina retardante llama**

Gant du cuisine retardateurs de feu  
Feuerhemmende Küchenhandschuh  
Fire retardant kitchen glove  
Luva de cozinha retardante de fogo

Ref	€	cm	Pack
60070	9,50	36	6



**ORKA**

220°C  
-30°C



**Guante silicona Profesional**

Gant de cuisine silicone  
Küchenhandschuh, Silikon  
Silicone oven glove  
Luva silicone

Ref	€	cm	Pack
60010	28,70	29	1
60011	47,00	42	1

200°C  
Max.



**Guante silicona Roja**

Gant de cuisine rouge silicone  
Küchenhandschuh aus Silikon  
Red silicon oven glove  
Luva silicone vermelho

Ref	€	cm	Pack
60017	22,30	29	12



**Guante silicona 5 dedos**

Gant en silicone 5 doigts  
Silikon Handschuh 5 fingers  
5 fingers silicone glove  
Luva silicone 5 dedos

Ref	€	cm	Pack
60034	7,70	27	40

200°C  
Max.

**Manoplas de silicona**

Mouflettes en silicone  
Fäustling aus Silikon  
Silicone mitten  
Pegas de silicone

Ref	€	Ø (cm)	Pack
R25921C	6,70	20-24-28	1
R25935C	6,70	31x25	1



180°C  
Max.

**Manoplas de silicona GRIS**

Mouflettes en silicone  
Fäustling aus Silikon  
Silicone mitten  
Pegas de silicone

Ref	€	Ø (cm)	Pack
R25921G	6,20	20-24-28	1
R25935G	6,20	31x25	1



**New**

180°C  
Max.



2  
Units

**Manoplas cobre asas**

Mouflette  
Handschuh  
Mitten  
Pegas cobre-asas

Ref	€	Pack
60012	7,80	12

180°C  
Max.

2  
Units

**Manoplas cobre asas**

Mouflette  
Handschuh  
Mitten  
Pegas cobre-asas

Ref	€	Pack
60052	7,80	12



180°C  
Max.

**Manopla de silicona**

Mouflette en silicone  
Fäustling aus Silikon  
Silicone mitten  
Pegas de silicone

Ref	€	Pack
60014	7,70	24



180°C  
Max.



Paelleras  
Paella Pans

#CocinaConLacor



## Inoxidable

### Paellera con tapa CHEF-LUXE

Plat rond avec couvercle  
Pfanne mit Deckel  
Round dish with lid  
Paelheira com tampa

Ref	€	Ø (cm)	h (cm)	e (mm)	L	Pack
54636	135,00	36	7,0	1,5	7,00	1
54640	154,90	40	8,0	1,5	10,00	1
54645	183,20	45	8,5	2,0	12,00	1
* 54650	234,80	50	9,0	2,0	17,00	1

\* NO inducción · NOT induction

### Paellera sin tapa CHEF-LUXE

Plat rond s/couvercle  
Pfanne ohne Deckel  
Round dish without lid  
Paelheira sem tampa

Ref	€	Pack
54636S	103,80	1
54640S	128,70	1
54645S	149,40	1
*54650S	191,00	1

\* NO inducción · NOT induction



### Paellera con tapa CHEF-CLASSIC

Plat rond a/couvercle  
Pfanne mit Deckel  
Round with lid  
Paelheira com tampa

Ref	€	Ø (cm)	h (cm)	e (mm)	L	Pack
50624	49,90	24	6,0	0,8	2,70	1
50628	68,00	28	6,0	0,8	3,60	1
50632	87,90	32	6,0	0,8	5,00	1
50636	111,20	36	7,0	1,0	7,10	1
50640	128,20	40	8,0	1,0	10,00	1
50645	150,60	45	8,5	1,0	13,50	1
50650	195,30	50	9,0	1,0	17,60	1
* 50660	282,30	60	9,0	1,0	25,40	1

\* NO inducción · NOT induction



### Paellera sin tapa WAGNER

Plat rond s/couvercle  
Pfanne ohne Deckel  
Round dish without lid  
Paelheira sem tampa

Ref	€	Ø (cm)	h (cm)	e (mm)	L	Pack
50624W	40,60	24	6,0	0,8	2,70	1
50628W	53,70	28	6,0	0,8	3,60	1
50632W	66,60	32	6,0	0,8	5,00	1
50636W	90,60	36	7,0	1,0	7,10	1
50640W	103,50	40	8,0	1,0	10,00	1
50645W	119,40	45	8,5	1,0	13,50	1
50650W	161,50	50	9,0	1,0	17,60	1
*50660W	229,90	60	9,0	1,0	25,40	1

\* NO inducción · NOT induction



### Paellera sin tapa ECO-CHEF

Plat rond sans couvercle  
Pfanne ohne Deckel  
Round without lid  
Paelheira sem tampa

Ref	€	Ø (cm)	h (cm)	e (mm)	L	Pack
57624	32,50	24	6,5	0,8	3,00	1
57628	45,20	28	6,5	0,8	4,00	1
57632	57,60	32	7,0	0,8	5,00	1
57636	74,00	36	7,0	1,0	7,10	1
57640	85,30	40	8,0	1,0	10,00	1

### Paellera Valenciana Inox 18/10

Plat à paella inox 18/10  
Paellapfanne, Rostfrei 18/10  
Round dish for paella s. steel 18/10  
Paelheira valenciana Inóx 18/10

Ref	€	Ø (cm)	Raciones	Pack
60130	49,40	30	4	1
60134	60,20	34	6	1
60138	71,90	38	8	1
60142	87,90	42	10	1
60146	104,50	46	12	1
60150	135,20	50	14	1
60155	172,10	55	16	1
60160	213,90	60	18	1



### Paellera Valenciana Inox 18/10 antiadherente

Plat à paella inox 18/10 anti-adhesif  
Paellapfanne, Rostfrei 18/10, Antihaf  
Round dish for paella s. steel 18/10 non-stick  
Paelheira valenciana Inóx 18/10 anti-aderente

Ref	€	Ø (cm)	Raciones	Pack
60224	44,70	24	1	1
60228	51,70	28	3	1
60232	60,50	32	5	1
60236	72,20	36	7	1
60240	86,40	40	9	1
60245	108,50	45	12	1
60250	130,60	50	14	1



## Aluminio



### Paellera CHEF-ALUMINIO

Plat rond  
Pfanne  
Round  
Paelheira

Ref	€	Ø (cm)	h (cm)	L	Pack
20628	32,50	28	7,0	4,30	1
20630	34,60	30	6,5	4,75	1
20632	36,90	32	7,0	5,50	1
20634	39,10	34	7,0	6,35	1
20636	41,40	36	7,5	7,45	1
20638	42,00	38	7,5	8,60	1
20640	49,40	40	8,0	10,05	1
20645	54,00	45	8,0	12,50	1
20650	62,90	50	8,0	15,50	1
20655	75,40	55	9,0	21,00	1
20660	89,90	60	10,0	28,00	1



### Paellera Robust Aluminio

Plat rond Robust aluminium  
Paellapfanne Robust, Aluminium  
Round dish Robust aluminium  
Paelheira Robust alumínio

Ref	€	Ø (cm)	h (cm)	Pack
23724	17,90	24	4,00	1
23728	23,60	28	4,50	1
23732	27,70	32	5,00	1
23736	33,50	36	5,50	1
23740	41,40	40	6,00	1



Antiadherente reforzado con **Titanio**

## Quantanium®

Advanced **Titanium** reinforced nonstick

**Revestimiento antiadherente interior y exterior de alta calidad**  
**Asas robustas generadas junto con la pieza en el proceso de fundición**  
**Pueden ser utilizadas en hornos convencionales hasta una temperatura máxima de 300°C**

Revêtement intérieur et extérieur antiadhésif de grande qualité  
Poignées robustes créées avec la pièce lors du processus de fonte  
Peuvent être utilisées dans des fours fonctionnels jusqu'à une température maximum de 300°C

Hochwertige Antihalt-Beschichtung innen und außen  
Robuste Tragegriffe, die zusammen mit dem Produkt während des Guß-Vorgangs hergestellt werden  
Sie können in konventionellen Öfen bis zu einer Höchsttemperatur von 300°C verwendet werden

High-quality interior and exterior non-stick coating  
Robust handles produced together with the piece in the casting process  
Can be used in conventional ovens up to a maximum temperature of 300°C

Revestimento antiaderente interior e exterior de alta qualidade  
Asas robustas, geradas junto com a peça no processo de fundição  
Podem utilizar-se em fornos convencionais, até uma temperatura máxima de 300° C



### Paellera aluminio fundido

Plat à paella Aluminium fondu carré  
Pfanne Aluminiumguss  
Cast Aluminium round dish  
Paelheira alumínio fundido

Ref	€	Ø (cm)	h (cm)	L	Pack
25132	55,50	32	7,0	4,50	6
25136	65,70	36	7,0	6,00	6
25140	90,80	40	7,0	8,00	6



## Acero



**Paellera STEEL PRO**  
Plat à paella  
Paellapfanne  
Round dish for paella  
Paelheira

Ref	€	Ø (cm)	Raciones	Pack
63621	5,20	20	1	6
63623	5,30	22	1	6
63625	5,40	24	1	6
63627	6,10	26	2	6
63629	6,30	28	3	6
63631	6,90	30	4	6
63633	7,60	32	5	6
63635	8,30	34	6	6
63637	8,90	36	7	6
63639	9,90	38	8	6
63641	10,80	40	9	6
63643	12,40	42	10	6
63647	14,10	46	12	5
63651	16,80	50	14	5
63656	27,50	55	16	5
63661	32,50	60	19	4
63666	40,30	65	22	4
63671	57,30	70	25	1
63681	78,80	80	40	1
63691	110,10	90	50	1
63115	328,20	115	120	1
63130	681,50	130	200	1

**Con 4 asas**  
With 4 handles

**Con 6 asas**  
With 6 handles



**Paellera antiadherente STEEL**  
Plat à paella, antiadhesive  
Paellapfanne, Antihaft  
Round dish for paella, non stick  
Paelheira anti-aderente

Ref	€	Ø (cm)	Raciones	Pack
60127	16,10	28	3	1
60131	18,30	32	5	1
60135	21,20	36	7	1
60139	23,60	40	9	1
60144	31,60	45	12	1
60149	37,70	50	14	1
60159	48,80	60	19	1



**Paellera esmaltada**  
Plat à paella  
Paellapfanne, emailiert  
Round dish for paelle  
Paelheira esmaltada

Ref	€	Ø (cm)	Raciones	Pack
60141	19,20	40	9	6
60151	29,40	50	14	4
60161	46,30	60	19	4

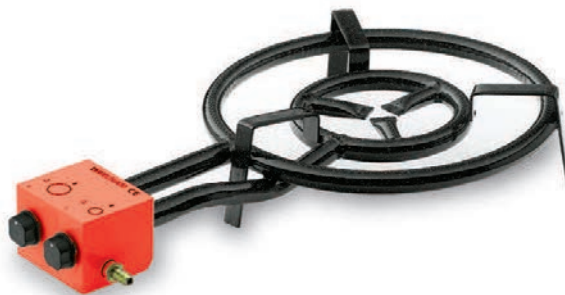

**Paellero Gas Butano**  
Rechaud  
Ständer fuer Brenner  
Burner  
Paelheira gás butanos

Ref	€	Ø (cm)	Quemadores	Kw	Presión (mbar)	Pack	Paelleras recomendadas
63731	37,90	30	1	6,50	37	1	Ø36-38-40-42-46
63741	65,70	40	2	11,40	37	1	Ø28-30-32-34-36-46-50-55
63751	86,80	50	2	14,10	37	1	Ø38-40-42-46-60-65-70
63761	122,30	60	3	21,00	37	1	Ø28-30-32-34-36-46-50-55-70-80
63771	201,00	70	3	24,50	37	1	Ø38-40-42-46-60-65-70-80-90

**Válido propano y butano · NO válidas Gas Natural y Gas Ciudad**  
Valid propane and butane · NOT valid Natural Gas and Gas City



**Soporte paellero**  
Pied pour rechaud  
Gaskocher-Stände  
Base for burner  
Cuporte paelheira

Ref	€	Pack
63700	37,70	1









UTENSILIOS

•

UTENSILS

Juegos de Cocina

*Kitchen Tools*

•

Preparación

*Food Processing*

•

Básculas+Termómetros

*Scales+Thermometers*

## U.P

### Cacillo

Louche  
Schöpfkelle  
Ladle  
Concha



Ref	€	Ø (cm)	L (cm)	L	Pack
60306	8,20	6,50	33,50	0,07	6
60308	9,40	8,00	33,50	0,12	6
60309	10,00	9,00	44,50	0,20	6
60310	11,30	10,00	44,50	0,25	6
60312	13,20	12,00	49,00	0,50	6
60314	17,00	14,00	54,00	0,75	6
60316	17,50	16,00	55,50	1,00	6

### Cacillo Perforado

Louche perforee  
Schöpfkelle, gelocht  
Perforated ladle  
Concha perforada



Ref	€	Ø (cm)	L (cm)	L	Pack
61308	8,70	8	39	0,12	6
61310	11,30	10	46	0,25	6
61312	13,20	12	47	0,50	6

### Cuchara Lisa

Cuillère lisse  
Servierlöffel  
Spoon  
Colher lisa



Ref	€	Ø (cm)	L (cm)	Pack
60507	8,70	7,50	47	6

### Cuchara Perforada

Cuillère perforee  
Servierlöffel, gelocht  
Perforated spoon  
Colher perforada



Ref	€	Ø (cm)	L (cm)	Pack
60508	10,40	7,50	47	6

### Espátula Lisa

Spatule lisse  
Backschaufel  
Spatula  
Espátula lisa



Ref	€	cm	L (cm)	Pack
61410	9,90	10	49,50	6
61412	11,20	12	50,50	6

### Espátula Perforada

Spatule perforee  
Backschaufel, gelocht  
Perforated spatula  
Espátula perforada



Ref	€	cm	L (cm)	Pack
61411	10,30	10	49,50	6
61413	11,40	12	50,50	6

### Espumadera

Ecumoire  
Schaumlöffel  
Skimmer  
Escumadeira



Ref	€	Ø (cm)	L (cm)	Pack
60408	7,60	8	34,00	6
60410	9,30	10	48,00	6
60412	9,50	12	49,50	6
60414	12,80	14	55,00	6
60416	13,90	16	57,00	6

### Paleta de pescado Profesional

Pelle à poisson Professionnel  
Fischheber, professional  
Professional long fish turner  
Espátula de peixe profissional



Ref	€	cm	L (cm)	Pack
62988	16,00	20,5x8	37,00	6

### Cuchara oblicua

Cuillère oblique  
Gießlöffel, quer  
One piece crosswire spoon  
Colher oblíqua



Ref	€	Ø (cm)	ml	Pack
60509	11,70	7,5x34	70	6

### Tenedor

Fourchette  
Tranchiergabel  
Fork  
Garfo



Ref	€	Puntas	L (cm)	cm	Pack
60002	12,50	2	57	7x7	6
60003	13,80	3	57	7x7	6

**Espumadera alambre**

Ecumoire à friture  
Fritierlöffel  
Skimmer  
Escumadeira arame



Ref	€	Ø (cm)	L (cm)	Pack
60409	10,00	10	47,50	6
60411	10,90	12	50,00	6
60413	13,20	14	51,00	6
60415	14,70	16	53,00	6
60417	17,00	18	62,00	6
60419	20,50	20	62,00	6
60423	26,10	24	73,00	6
60427	30,60	28	73,00	6

**Rasera alambre**

Araignée à fil  
Fritierlöffel  
Mesh skimmer  
Escumadeira arame



Ref	€	Ø (cm)	L (cm)	Pack
67410	11,10	10	37,00	6
67412	15,00	12	44,00	6
67415	24,10	15	55,50	6
67417	28,30	17	56,00	6
67420	34,40	20	58,00	6

**Espumadera alambre**

Ecumoire etamee  
Fritierschaufel  
Tinned skimmer  
Escumadeira de arame



Ref	€	Ø (cm)	L (cm)	Pack
63514	9,50	14	54,00	10
63516	10,00	16	56,50	10
63518	10,40	18	56,50	10
63520	12,80	20	67,00	10
63524	14,20	24	70,50	10
63528	17,00	28	76,00	10

**Alambre estañado** · Tinned wire

**Colador doble malla**

Passoir maillee  
Passiersieb, stark  
Mesh strainer  
Coador rede dupla



Ref	€	Ø (cm)	Pack
61316	6,40	16	12
61318	7,40	18	12
61320	8,40	20	12
61323	21,70	23	12
61326	23,60	26	12
61330	42,60	30	12
61335	51,40	35	6

**2 Ganchos**  
2 Hooks

**1 Gancho**  
1 Hook

**Alambre estañado** · Tinned wire

**Tenedor**

Fourchette etamee  
Tranchiergabel  
Tinned fork  
Garfo



Ref	€	L (cm)	cm	Pack
64040	6,10	40,50	7x7	12
64060	7,20	60,50	7,5x9	12

**Alambre estañado** · Tinned wire

**Nidos de alambre**

Panier à nid  
Nestbacklöffel  
Bird's nest mould  
Ninhos de arame



Ref	€	cm	Pack
62957	18,10	7-9	1
62959	21,30	9-11	1

**Cazo servir 'POCHON'**

Pochon  
Suppenkelle "Pochon" (Fur server)  
Pochon soup ladle for server  
Çaçarole servir "Pochon"



Ref	€	Ø (cm)	Mango (cm)	L	Pack
60520	48,30	20	22,50	2,00	6

**Cuchara apoya utensilios**

Cuillère ramasse ustensiles  
Löffelsammler in Geschirr  
St steel spoon holder utensils  
Colher recolhe utensilios



Ref	€	L (cm)	Pack
62972	9,40	25	12



## Buffet

### Cacillo

Louche  
Schöpfkelle  
Ladle  
Concha



Ref	€	ml	Ø (cm)	Pack
72853	9,00	0,07	6x24,5	6

### Cacillo salsa

Louche sauce  
Saucengliesslöffle  
Gravy ladle  
Concha para molho



Ref	€	ml	L (cm)	Pack
72850	8,90	0,10	23,50	6

### Cuchara Lisa

Cuillère lisse  
Servierlöffel  
Spoon  
Colher lisa



Ref	€	L (cm)	Pack
72857	8,10	27,50	6

### Cuchara Perforada

Cuillère perforee  
Servierlöffel, gelocht  
Perforated spoon  
Colher perfurada



Ref	€	L (cm)	Pack
72858	8,20	27,50	6

### Espumadera

Ecumoire  
Schaumlöffel  
Skimmer  
Escumadeira



Ref	€	Ø (cm)	Pack
72854	9,90	Ø8x27	6

### Espátula Perforada

Spatule perforee  
Pfannenschaufel, gelocht  
Perforated spatula  
Espátula perfurada



Ref	€	L (cm)	Pack
72859	9,00	28,50	6

### Tenedor

Fourchette  
Tranchiergabel  
Fork  
Garfo



Ref	€	L (cm)	Pack
72855	7,20	28,50	6

### Pala ensalada

Pelle à salade  
Salatschaufel  
Salat scoop  
Espátula de salada



Ref	€	L (cm)	Pack
72851	8,50	28,00	6

### Pala pastel perforada

Palette à gâteau perforee  
Kuchenschaufel, gelocht  
Perforated cake scoop  
Espátula de bolos



Ref	€	L (cm)	Pack
72856	9,00	31,50	6

## Profesional

Cacillo (72803)  
Espumadera (72804)  
Tenedor (72805)  
Cuchara lisa (72807)  
Espátula perforada (72809)  
Cacillo salsa (72810)

### Juego de cocina 6 piezas pie giratorio

6 Ustensiles de cuisine sur serviteur pivotant  
6 Tlg. Vorlegeteile auf Drehgestell  
6 piece kitchen tool set revolving rack  
Jogo de cozinha 6 peças pé giratório



Ref	€	h (cm)	Pack
72801	127,10		1
72831	37,70	44	6

**Soporte** · Hanging rack

Cacillo (72803)  
Espumadera (72804)  
Tenedor (72805)  
Cuchara lisa (72807)  
Espátula perforada (72809)  
Cacillo salsa (72810)

### Juego de cocina 6 piezas pared

6 utensiles de cuisine sur penderie murale  
6 Tlg. Vorlegeteile mit Hängeleiste  
6 piece kitchen tool set hanging rack  
Jogo de cozinha 6 peças parede



Ref	€	L (cm)	Pack
72802	100,40		1
62631	12,40	42,5	6

**Soporte** · Hanging rack

### Cacillo

Louche  
Schöpfkelle  
Ladle  
Concha



Ref	€	ml	Ø (cm)	Pack
72803	16,20	150	10x37	6

### Espumadera

Ecumoire  
Schaumlöffel  
Skimmer  
Escumadeira



Ref	€	L (cm)	Pack
72804	13,60	36,0	6

### Tenedor

Fourchette  
Tranchiergabel  
Fork  
Garfo



Ref	€	L (cm)	Pack
72805	10,70	35,50	6

### Espátula Lisa

Spatule lisse  
Backschaufel  
Spatula  
Espátula lisa



Ref	€	L (cm)	Pack
72806	11,40	39,0	6

### Cuchara Lisa

Cuillère lisse  
Servierlöffel  
Spoon  
Colher lisa



Ref	€	L (cm)	Pack
72807	12,00	36,0	12

### Cuchara Perforada

Cuillère perforee  
Servierlöffel, gelocht  
Perforated spoon  
Colher perfurada



Ref	€	L (cm)	Pack
72808	12,00	35,50	12

### Espátula Perforada

Spatule perforee  
Pfannenschaufel, gelocht  
Perforated spatula  
Espátula perforada



Ref	€	L (cm)	Pack
72809	13,20	39,0	12

### Cacillo salsa

Louche sauce  
Saucengliessleröffe  
Gravy ladle  
Concha para molho



Ref	€	ml	Ø (cm)
72810	12,10	50	6x28,5

### Servidor espaguetis

Cuillère à spaguëtis  
Spaghettiheber  
Spaguëtti server  
Servidor de esparguete



Ref	€	L (cm)	Pack
72811	12,70	34,0	12

## Super Monoblock

Cacillo (62603)  
Espumadera (62604)  
Tenedor (62605)  
Espátula (62606)  
Cuchara lisa (62607)

### Juego de cocina 5 piezas pie giratorio

5 Ustensiles de cuisine sur serviteur pivotant  
5 Tlg. Vorlegeteile auf Drehgestell  
5 piece kitchen tool set revolving rack  
Jogo de cozinha 5 peças pé giratório

Ref	€	h (cm)	Pack
62601	71,80		1
62630	19,00	40,0	1

**Soporte** · Hanging rack



Cacillo (62603)  
Espumadera (62604)  
Tenedor (62605)  
Espátula (62606)  
Cuchara lisa (62607)

### Juego de cocina 5 piezas pared

5 utens. de cuisine sur penderie murale  
Küche-Vorlegeteile, 5-tlg., mit Hängeleiste  
5 pcs. Kitchen tool set hanging rack  
Jogo de cozinha 5 peças parede

Ref	€	L (cm)	pack
62602	73,20		1
62631	12,40	42,5	1

**Soporte** · Hanging rack



### Cacillo

Louche  
Schöpfkelle  
Ladle  
Concha

Ref	€	ml	L (cm)	Pack
62603	13,40	100	31,00	6



### Espumadera

Ecumoire  
Schaumlöffel  
Skimmer  
Escumadeira

Ref	€	L (cm)	Pack
62604	13,40	36,50	6



### Tenedor

Fourchette  
Tranchiergabel  
Fork  
Garfo

Ref	€	L (cm)	Pack
62605	8,40	33,50	6



### Espátula

Spatule lisse  
Backschaufel  
Spatula  
Espátula

Ref	€	L (cm)	Pack
62606	9,40	33,50	6



### Cuchara Lisa

Cuillère lisse  
Servierlöffel  
Spoon  
Colher lisa

Ref	€	L (cm)	Pack
62607	9,90	32,00	6



### Cuchara Perforada

Cuillère perforée  
Servierlöffel, gelocht  
Perforated spoon  
Colher perfurada

Ref	€	L (cm)	Pack
62608	9,20	32,00	6



### Cacillo salsa

Louche sauce  
Saucengliesslöffle  
Gravy ladle  
Concha para molho

Ref	€	ml	L (cm)	Pack
62609	11,80	30	31,00	6



### Servidor spaguetis

Cuillère à spaguetis  
Spaghettiheber  
Spaguetti server  
Servidor de esparguete

Ref	€	L (cm)	Pack
62811	11,20	31,00	6



### Batidor

Fouet  
Rührbesen  
Whisk  
batedor

Ref	€	L (cm)	Pack
62812	8,70	30,00	6



## Monoblock

### Cacillo

Louche  
Schöpfkelle  
Ladle  
Concha



Ref	€	ml	L (cm)	Pack
62503	6,70	100	31,00	6

### Espumadera

Ecumoire  
Schaumlöffel  
Skimmer  
Escumadeira



Ref	€	L (cm)	Pack
62504	6,80	34,00	6

### Tenedor

Fourchette  
Tranchiergabel  
Fork  
Garfo



Ref	€	L (cm)	Pack
62505	4,50	32,00	6

### Espátula

Spatule lisse  
Backschaufel  
Spatula  
Espátula



Ref	€	L (cm)	Pack
62506	5,20	34,50	6

### Cuchara Lisa

Cuillère lisse  
Servierlöffel  
Spoon  
Colher lisa



Ref	€	L (cm)	Pack
62507	5,30	33,50	6



## Black

### Cacillo

Louche  
Schöpfkelle  
Ladle  
Concha



Ref	€	ml	cm	Pack
98903	3,00	125	30x9x7	12

### Espumadera

Ecumoire  
Schaumlöffel  
Skimmer  
Escumadeira



Ref	€	cm	Pack
98904	3,00	33x11x6	12

### Cuchara salsa

Cuillère sauce  
Saucenservierlöffel  
Gravy spoon  
Colher para molho



Ref	€	cm	Pack
98905	3,00	25x7x2	12

### Espátula perforada

Spatule perforée  
Schaufel, Gelocht  
Perforated spatula  
Espátula perforada



Ref	€	cm	Pack
98906	3,00	32x9x4	12

### Cuchara lisa

Cuillère  
Servierlöffel  
Spoon  
Colher lisa



Ref	€	cm	Pack
98907	3,00	30x7x5	12

### Cuchara perforada

Cuillère perforée  
Servierlöffel, gelocht  
Perforated spoon  
Colher perforada



Ref	€	cm	Pack
98908	3,00	30x7x5	12

### Paleta de pescado

Pelle à poisson  
Fischheber  
Fish turner  
Espátula de peixe



Ref	€	cm	Pack
98909	3,00	32x8x2	12

### Cacillo salsa

Louche sauce  
Saucengliesslöffel  
Gravy andle  
Concha para molho



Ref	€	cm	Pack
98910	3,00	27x8x5	12

### Servidor Spaguetis

Cuillère à spaguëtis  
Spaghettiheber  
Spaguëtti server  
Servidor de esparguete



Ref	€	cm	Pack
98911	3,00	29,00	12

### Espátula corta

Spatule court  
Palette, Kurz  
Short spatula  
Espátula corta



Ref	€	cm	Pack
98912	3,00	28x8x3	12

### Espátula larga

Spatule longue  
Palette, Lang  
Long spatula  
Espátula comprida



Ref	€	cm	Pack
98913	3,00	31x4x2	12

### Batidor

Fouët  
Schneebeesen  
Whisk  
Batedor



Ref	€	cm	Pack
98914	3,00	30x7x7	12

## Eco

### Cacillo

Louche  
Schöpfkelle  
Ladle  
Concha



Ref	€	ml	L (cm)	Pack
98803	3,90	110	30,0	12

### No rayan

Pensadas para rendir a la perfección con piezas antiadherentes

Ils ne rayent pas  
Conçus pour une efficacité optimum avec récipients antiadhésifs

Kein Verkratzen  
Töpfen und Pfannen und deshalb ideal für Antiafversiegelung

They do not scratch  
Designed to perform perfectly with non-stick parts

Não riscam  
Pensadas para tirar o máximo rendimento e perfeição com peças anti-aderentes

### Espumadera

Ecumoire  
Schaumlöffel  
Skimmer  
Escumadeira



Ref	€	L (cm)	Pack
98804	3,70	31,50	12

### Espátula perforada

Spatule perforee  
Schaufel, gelocht  
Perforated spatula  
Espátula perforada



Ref	€	L (cm)	Pack
98806	3,30	31,50	12

### Cuchara Lisa

Cuillère  
Servierlöffel  
Spoon  
Colher lisa



Ref	€	L (cm)	Pack
98807	3,20	30,50	12

### Cuchara Perforada

Cuillère perforee  
Servierlöffel, gelocht  
Perforated spoon  
Colher perforada



Ref	€	L (cm)	Pack
98808	3,10	30,50	12

### Cacillo salsa

Louche sauce  
Saucengliesslöffel  
Gravy ladle  
Concha para molho



Ref	€	ml	L (cm)	Pack
98810	2,90	40	28,0	12

### Servidor Spaguetis

Cuillère à spaguetis  
Spaghettiheber  
Spaghetti server  
Servidor de esparguete



Ref	€	L (cm)	Pack
98811	3,00	29,00	12

## Brun

### Cuchara ensalada

Cuillère à salade  
Salad Servierlöffel  
Salad spoon  
Colher de salada



Ref	€	L (cm)	Pack
68173	5,70	30,00	6

**Imprescindible en cualquier cocina por su resistencia a altas temperaturas y durabilidad**

**Conserva mejor los sabores de los alimentos al cocinarlos**

**Fabricadas en madera haya natural de alta calidad y acabadas con aceites naturales**

**Gran mango que hace muy fácil el agarre y el manejo en la cocina**

**Apta para uso en sartenes con revestimiento antiadherente**

Indispensable dans toute cuisine en raison de sa résistance aux hautes températures et sa durabilité

Conserve mieux les saveurs des aliments lors de leur cuisson

Fabriquées en hêtre naturel de grande qualité et dotées d'une finition aux huiles naturelles

Grand manche qui rend très facile la prise en main et la manipulation dans la

Apte pour un usage sur des poêles avec revêtement antiadhésif cuisine

Sehr temperaturbeständig und langlebig und daher in jeder Küche unentbehrlich  
Geschmack der Lebensmittel bleibt beim Kochen besser erhalten

Aus naturbelassenem Buchenholz von hoher Qualität und mit organischer Lasur  
hr guter Handgriff, der das Greifen und die Handhabung in der Küche erleichtert  
Zur Verwendung mit antihafbeschichteten Pfannen geeignet

Essential in any kitchen because of their resistance to high temperatures and their durability

Better preserve the flavours of cooked food

Made from natural beech wood of high quality and finished with natural oils

Large handle making it very easy to pick up and manipulate when cooking

Suitable for use in frying pans with non-stick coating

Imprescindível em qualquer cozinha pela sua durabilidade e resistência a altas temperaturas

Conservam melhor os sabores dos alimentos ao cozinhá-los

Fabricados em madeira de faia natural de alta qualidade e com acabamento de óleos naturais

Mango de grandes dimensões, que facilita o agarre e o manejo na cozinha

Apta para uso em sertãs com revestimento antiaderente

### Tenedor ensalada

Fourchette à salade  
Salad Tranchiergabel  
Salad fork  
Garfo de salada



Ref	€	L (cm)	Pack
68174	5,70	30,00	6

### Cuchara lisa

Cuillère  
Servierlöffel  
Spoon  
Colher lisa



Ref	€	L (cm)	Pack
68175	4,90	30,00	6

### Cuchara perforada

Cuillère perforee  
Servierlöffel, gelocht  
Perforated spoon  
Colher perfurada



Ref	€	L (cm)	Pack
68176	5,20	30,00	6

### Espátula lisa

Spatule  
Backschauffel  
Spatule  
Espátula lisa



Ref	€	L (cm)	Pack
68177	4,90	30,00	6

### Espátula perforada

Spatule perforee  
Backschauffel, gelocht  
Perforated spatule  
Espátula perfurada



Ref	€	L (cm)	Pack
68178	5,10	30,00	6

### Cuchara especial

Cuillère spécial  
Special Servierlöffel  
Special spoon  
Colher especial



Ref	€	L (cm)	Pack
68179	5,30	30,00	6

## Natura



**Fabricadas en bambú natural, un complemento ideal para cualquier cocina**  
**Conserva los sabores de los alimentos al cocinarlos**  
**Robustos y muy resistentes por su resistencia a altas temperaturas**  
**Permiten remover los alimentos sin rayar las cacerolas y sartenes con antiadherente**  
**Mango de silicona, facilita el agarre y manejo en la cocina**

Fabriquéés en bambou naturel, il s'agit d'un accessoire idéal pour tout type de cuisine  
 Conserve les saveurs des aliments à la cuisson  
 Robustes et très résistants car ils supportent des températures élevées  
 Permettent de remuer les aliments sans rayer les casseroles et les poêles avec antiadhésif  
 Manche en silicone, qui facilite la prise en main et la maniabilité dans la cuisine

Aus Naturbambus gefertigt, das ideale Zubehör für jede Küche  
 Behält die Aromen der Speisen beim Kochen  
 Robust und sehr widerstandsfähig wegen seiner hohen Temperaturbeständigkeit  
 Entfernt Lebensmittel aus Töpfen und Pfannen ohne die Antihafbeschichtung  
 Silikon-Griff für leichteres Fassen und Handhabung in der Küche

Made of natural bamboo, it is the perfect accessory for any kitchen  
 Preserves the flavours of food when cooking  
 Robust and highly durable thanks to their resistance to high temperatures  
 Enable you to stir food without scratching pots and pans with non-stick coating  
 Silicone handle for easy grip and handling in the kitchen

Fabricadas em bambu natural, um complemento ideal para qualquer cozinha  
 Conserva os sabores dos alimentos ao cozinhá-los  
 Robustos e resistentes a altas temperaturas  
 Permitem mexer os alimentos sem riscar as caçarolas e as sertãs antiaderente  
 Mango de silicone, que facilita a sujeição e o manejo na cozinha



### Cuchara-Tenedor ensalada GREY

Cuillère-Fourchette à salade  
 Servierlöffel-Schauffel, Salad  
 Salad spoon-fork  
 Garfo-Colher de salada

Ref	€	L (cm)	Pack	
68183	7,60	32	6	Cuchara · Spoon
68184	7,60	32	6	Tenedor · Fork



### Cuchara-Tenedor ensalada WHITE

Cuillère-Fourchette à salade  
 Servierlöffel-Schauffel, Salad  
 Salad spoon-fork  
 Garfo-Colher de salada

Ref	€	L (cm)	Pack	
68193	7,60	32	6	Cuchara · Spoon
68194	7,60	32	6	Tenedor · Fork

### Espátula silicona con termómetro sonda

Spatule en silicone avec Thermometre sonde  
 Teigschaber mit Thermometer Messfüler  
 Silicone spatula with Thermometer probe  
 Espátula silicone com Termómetro sonda



Ref	€	L (cm)	Pack
62500	13,00	29	12

### Cuchara silicona con termómetro sonda

Cuillère en silicone avec Thermometre sonde  
 Digikonlöffel mit Thermometer Messfüler  
 Silicone spoon with Thermometer probe  
 Colher silicone com Termómetro sonda



Ref	€	L (cm)	Pack
62528	14,00	29	12





## Utensilios



Inox

### Contenedor de cubiertos

Panier à couverts  
Besteckköcher  
Cuttlery holder  
Copos para talheres

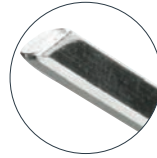

Sección cuadrada  
(2,5x2,5 mm)  
Square section

### Pincho moruno (6) Inox

Brochette carre en inox. (6)  
Fleischspiesse (6), Rostfrei  
St. steel skewers square wire (6)  
Espeto moruno Inóx (6)



Ref	€	Ø (cm)	h (cm)	L	Pack
62962	16,10	12	13,6	1,40	6
62963	19,00	12	18,7	2,00	6

Ref	€	L (cm)	Pack
62446	3,90	20,0	12
62435	4,50	30,5	12
62445	5,40	40,5	12

### Barra sujeción notas aluminio

Barre à notes en Aluminium  
Zettelhalter, Aluminium  
Aluminium Order rall  
Barra fixação notas alumínio



AL  
Aluminium

Ref	€	L (cm)	Pack
60731	9,50	30,50	6
60746	12,50	46,00	6
60761	14,80	61,00	6
60776	17,10	76,00	6
60791	21,30	91,50	6



### Colgador de barra Inox 18/10

Penderie murale Inox 18/10  
Hängeleiste, Rostfrei 18/10  
S. Steel 18/10 Wall hanger  
Suporte de barra Inóx 18/10

Ref	€	Unidades	L (cm)	Pack
60740	18,20	6	40	72
60760	25,20	8	60	50
60710	34,70	12	100	30

### Juego de 6 ganchos Inox 18/10

Ensemble 6 crochets en Inox 18/10  
Aufhängehaken, 6er.-Set, Rostfrei 18/10  
S. Steel 18/10 6 hook set  
Jogo de 6 ganchos Inóx 18/10



Ref	€	Pack
60700	5,30	12

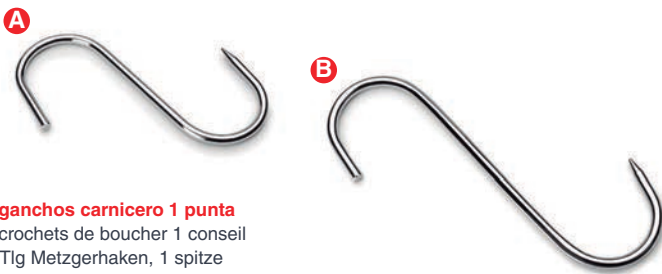

### 6 ganchos carnicero 1 punta

6 crochets de boucher 1 conseil  
6-Tlg Metzgerhaken, 1 spitze  
6 butchers hook 1 point  
6 ganchos de carnicero 1 ponta

	Ref	€	Ø (mm)	L (cm)	Pack
A	39043	8,90	6	12,5	4
B	39044	14,00	6	18,5	4



### 6 ganchos carnicero 2 puntas

6 crochets de boucher 2 conseils  
6-Tlg Metzgerhaken, 2 spitze  
6 butchers hook 2 points  
6 ganchos de carnicero 2 pontas

	Ref	€	Ø (mm)	L (cm)	Pack
A	39047	8,90	6	12,5	4
B	39048	14,00	6	18,5	4



Preparación  
Food Processing  
#CocinaConLacor

## Espátulas

### Rasqueta Inox

Coupe pate en Inox  
Schaufel, Edelstahl  
OSt. steel scraper  
Raspador Inóx



Ref	€	cm	Pack
67029	7,50	16,5x11	6

### Rasqueta silicona

Coupe pate en Silicone  
Schaufel, Silikon  
Silicone chopper  
Raspador silicone



Ref	€	cm	Pack
67414	7,40	9x15	6

### Rasqueta Inox 18/10

Coupe pate en Inox 18/10  
Einhand-Wiegemesser, Edelstahl 18/10  
St steel 18/10 hopper-scraper  
Raspador en Inóx 18/10



	Ref	€	cm	Pack
<b>A</b>	67005	10,10	15x9	1
<b>B</b>	67006	10,00	15x9	1

### Espátula Silicona

Spatule en silicone  
Teigschaber  
Silicone spatula  
Espátula de silicone

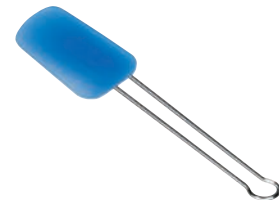

	Ref	€	cm	Pack
	67434	3,70	7,5x5	12
	67435	4,20	9x6	12

### Espátula Silicona

Spatule en silicone  
Teigschaber  
Silicone spatula  
Espátula de silicone

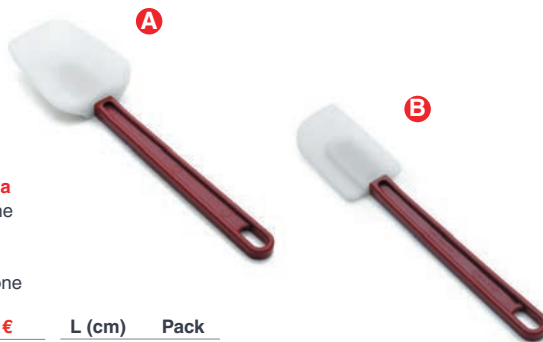

	Ref	€	L (cm)	Pack
<b>A</b>	64450	4,40	25	6
	64451	7,20	35	6
<b>B</b>	64460	4,70	25	6
	64461	7,80	35	6

### Espátula Silicona

Spatule en silicone  
Teigschaber  
Silicone spatula  
Espátula de silicone



	Ref	€	L (cm)	Pack
	67421	3,60	20	12
	67427	5,50	26	12
	67433	12,10	32	12

### Espátula Silicona

Spatule en silicone  
Teigschaber  
Silicone spatula  
Espátula de silicone



	Ref	€	L (cm)	Pack
<b>A</b>	64444	4,70	28	12
<b>B</b>	64445	5,30	30	12
<b>C</b>	64446	5,40	31	12



**Set repostería (20 pcs.)**

Exposant pâtisserie  
Ausstellendkasten, pastry  
Pastry display  
Expositor pastelaria

	Ref	€	L (cm)	Pieza	Pack
<b>A</b>	64424	60,10	-	Caja (20 pcs) / Set (20 pcs)	1
<b>B</b>	64426	3,00	23,0	Pincel / Brush	12
<b>C</b>	64427	3,00	23,0	Espátula / Spatula	12
<b>D</b>	64428	3,00	23,0	lingua gato / Spatula	12
<b>E</b>	64429	3,00	23,0	Batidor / Whisk	12

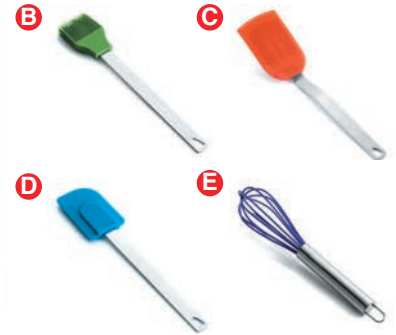
**Espátula grill acodada**

Spatule coudée our grill  
Winkelplatte, Feststoffe, Rostfrei  
Bent grillspatula  
Espátula comprida grelha

Ref	€	cm	Pack
60434	4,60	12x27	6

**Espátula flexible pescado**

Spatule flexible à poisson  
Fisch Schaufel, flexible  
Flexible spatula to fish  
Espátula flexível para peixe

Ref	€	L (cm)	Pack
60426	3,50	30	1



2 en 1

**Espátula serrada**

Spatule à gâteau  
Backschaufel  
Serrated spatula  
Espátula com serrilha

Ref	€	cm	Pack
62677	7,10	30x5,5x5	6

**Espátula plancha mango solido Inox**

Spatule m/solide en Inox  
Grillschaufel f. Feststoffe, Rostfrei  
St. Steel straight spatula  
Espátula grelha cabo sólido Inóx

Ref	€	cm	Pack
60422	3,60	10x11,5	12

**Espátula recta m/solido Inox**

Spatule m/solide en Inox  
Schaufel, gerade, f. Feststoffe, Rostfrei  
St. Steel straight spatula  
Espátula cabo sólido Inóx

Ref	€	cm	Pack
60425	3,80	7x13,5	12

**Paleta triangular mango solido Inox**

Grattoir manche noir m/solide en Inox  
Bratenspachtel, m/schwarzem Stiel, f. Feststoffe  
St. Steel straight Scraper/turner  
Espátula triangular cabo sólido Inóx

Ref	€	cm	Pack
60430	5,40	10x11,5	12



**Espátula lisa mango solido Inox**

Spatule lisse m/solide en Inox  
Backschaufel, f. Feststoffe, Rostfrei  
St. steel straight spatula  
Espátula lisa cabo sólido Inóx

	Ref	€	cm	Pack
<b>A</b>	60420	4,30	7,5x21,5	12
<b>B</b>	60421	4,20	7,5x21,5	12

**Espátula mango negro**

Spatule manche noir  
Schaufel mit schwarzem Stiel  
Solid turner w/black H.  
Espátula cabo negro

	Ref	€	L (cm)	Pack
<b>A</b>	60435	6,10	35	6
<b>B</b>	60438	6,20	35	6

**Espátula mango madera**

Spatule manche en bois  
Schaufel mit Holzstiel  
Solid turner w/wooden hand.  
Espátula cabo madeira

	Ref.	€	cm	Pack
<b>A</b>	60428	6,10	28x7,1	12
<b>B</b>	60436	6,90	36x7,2	12
<b>C</b>	60437	6,90	36x7,2	12

**Espátula larga recta mango solido Inox**

Spatule longue droite m/solide en Inox  
Palette, lang, gerade, f. Feststoffe, Rostfrei  
St. Steel long straight spatula  
Espátula comprida c/cabo sólido Inóx

Ref	€	L (cm)	Pack
60461	3,00	15	12
60462	3,10	20	12
60463	3,20	25	12
60464	3,30	30	12
60465	3,40	35	12

**Espátula larga acodada mango solido Inox**

Spatule longue coudée m/solide en Inox  
Winkelpalette, lang, f. Feststoffe, Rostfrei  
St. Steel Long bent spatula  
Espátula comprida c/cabo sólido Inóx

Ref	€	L (cm)	Pack
60467	3,20	20	12
60468	3,30	25	12
60469	3,40	30	12

Inox  
18/10**Espátula pizza**

Spatule pizza  
Pizzaspatel  
Pizza spatula  
Espátula pizza

Ref	€	cm	Pack
60424	11,40	16,5x17,5x5	12

ABS  
Plastic

Inox

**Pala Pizza Inox**

Pelle pizza en Inox  
Pizzaoefen-schaufel, edelstahl  
St. steel pizza flat scoop  
Espátula Pizza Inóx

Ref	€	cm	Pack
61461	11,60	25x36	6

**Pala Profesional Polietileno**

Pelle Professionnelle Polyéthylène  
 Professionelle Ruhrspatel, Polyethylen  
 Polyethylene Professional shovel  
 Pá Profissional Polietileno

Ref.	€	L (cm) Total	Pack
60404	64,60	84	12

**Espátula gigante Inox**

Spatule geante en Inox  
 Rührspatel, Edelstahl  
 St steel long handle Turner  
 Espátula gigante Inox

Ref.	€	L (cm)	Pack
61481	55,10	80	1
61421	60,40	120	1

**Pala Pizza mango desmontable 18% Cr.**

Pelle Pizza manche desmontable en 18%Cr.  
 Pizzaofen-Schaufel, viereckig, 18%Cr.  
 Square Pizza oven scoop, 18%Cr.  
 Pá de pizza cabo desmontável 18% Cr.

Ref.	€	L (cm)	Pack
61460	84,40	160	1

**Cortapizza**

Roulette pizza  
 Pizzaschneider  
 Pizza cutter  
 Corta-Pizza

	Ref	€	Ø (cm)	Pack
<b>A</b>	60429	4,00	10	12
<b>B</b>	67004	14,20	10	6
<b>C</b>	67028	10,00	10	12
<b>D</b>	67027	4,70	8	12

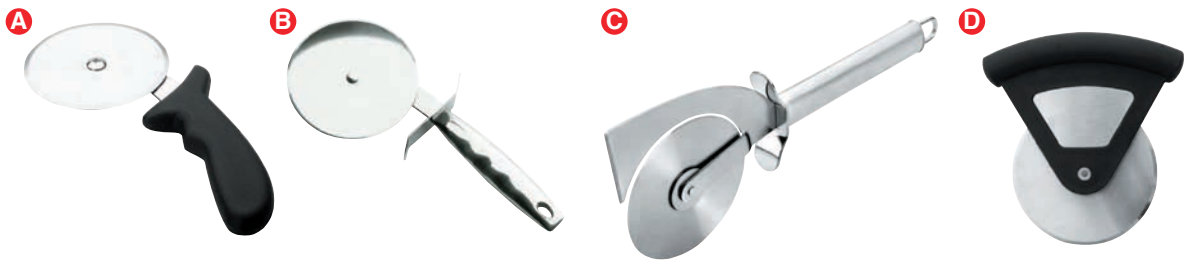

## Batidores

SI 250°C  
Silicone max.

### Batidor silicona FIBREGLASS

Fouet en silicone FIBREGLASS  
FIBREGLASS Schneebesen, Silikon  
FIBREGLASS silicone whisk  
Batedores silicona FIBREGLASS



Ref	€	L (cm)	Pack
61524	8,70	25	6
61529	9,60	30	6
61534	11,20	35	6
61539	11,70	40	6

Indeformable - Ergonomic  
Indeformable - Ergonomic

### Batidor FIBREGLASS

Fouet FIBREGLASS  
FIBREGLASS Schneebesen  
FIBREGLASS Whisk  
Batedores FIBREGLASS



Ref	€	L (cm)	Pack
61624	9,70	25	6
61629	11,10	30	6
61634	12,60	35	6
61639	14,00	40	6
61644	16,70	45	6
61649	17,50	50	6

Indeformable - Ergonomic  
Indeformable - Ergonomic

### Batidor EXTRA 8

Fouet inox extra 8  
Schneebesen, Extra 8  
Extra 8 whisk  
Batidor Extra 8



Ref	€	L (cm)	Pack
61625	7,00	25	12
61630	7,10	30	12
61635	7,50	35	12
61640	8,30	40	12
61645	8,90	45	12
61650	10,10	50	12
61655	10,60	55	12
61660	11,50	60	12

### Batidor SUPER 12

Fouet inox super 12  
Schneebesen, super 12  
Super 12 whisk  
Batidor Super 12



Ref	€	L (cm)	Pack
61626	6,40	25	12
61631	6,90	30	12
61636	7,50	35	12
61641	7,90	40	12
61646	8,20	45	12
61651	8,90	50	12

SI 250°C  
Silicone max.

### Batidor varilla silicona

Fouet en silicone  
Rührbesen auf Silikon  
Silicone wirw whisk  
Batidor vareta silicone



Ref	€	L (cm)	Pack
61621	6,40	20	12
61622	7,10	25	12
61623	7,80	30	12

### Batidor MINI Inox

Mini fouet Inox  
Mini-Schneebesen  
Mini whisk  
Mini batedor Inóx



Ref	€	L (cm)	Pack
61615	4,40	15	6
61620	4,90	20	6



### Batidor manivela Inox 18% Cr.

Batteur-mélangeur à manivelle 18% Cr.  
Schneequir  
Egg beater 18% Cr.  
Batedor de manivela Inóx 18%Cr.

Ref	€	Pack
62901	15,00	12

### Batidor Capuccino

Batteur pour Cappuccino  
Capuccino- Mixer  
Capuccino mixer  
Batedor capuccino



Ref	€	W	Pack
69041	20,70	2,7	1

**Batidor Gigante**

Fouet á purée  
Kesselbesen  
Big whisk  
Batedor gigante



Ref.	€	cm	Pack
60610	49,80	100	1
60612	63,70	129	1

**Pinceles**

**Pincel virola Inox mango Polipropileno**

Pinceau patisier V. Inox M. Polipropylene  
Fett-/Kuchenpinsel, mit Stiel aus Polypropylen, schaft Edelstahl  
Flat pastry brush s.steel Polypropylene handle  
Pincel aro Inóx cabo polietileno



Ref	€	cm	Pack
64430	3,40	4,4x3,0	20
64435	4,00	4,4x3,5	20
64440	4,20	4,4x4,0	20
65044	5,20	5,0x4,5	20
65050	6,20	5,0x5,0	20



**Pincel de Silicona**

Pinceau en silicone  
Silikonpinsel,  
Silicon brush  
Pincel de silicone



Ref	€	L (cm)	Pack
64441	5,00	23	12

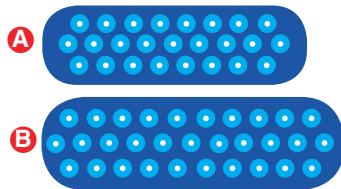

Dimensiones Reales - Real Dimensions

**Pincel de silicona mango Inox**

Pinceau de cuisine embout en silicone  
Silikonpinsel, langer stiel  
Silicone brush st.steel long handle  
Pincel de silicone cabo Inóx 18/10



	Ref	€	L (cm)	Pack
<b>A</b>	64425	5,30	24	12
<b>B</b>	64431	5,70	24	12

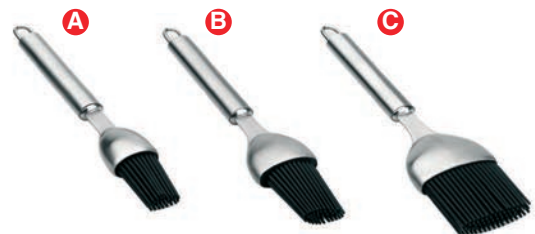

**Pincel de Silicona Inox 18/10**

Pinceau en silicone Inox 18/10  
Silikonpinsel, Rostfrei 18/10  
St. steel 18/10 silicon brush  
Pincel silicone inóx 18/10

	Ref	€	L (cm)	Pack
<b>A</b>	64418	8,60	22	6
<b>B</b>	64422	9,80	23	6
<b>C</b>	64438	10,40	24	6



## Utensilios huevo

**Separador de claras**

Séparateur à oeuf  
Eier-Separator  
Eggs separator  
Separador de ovos



Ref	€	Pack
61608	6,20	1

**Fabricados en acero inoxidable 18/10, garantiza resistencia, durabilidad e higiene**

**Asegura una separación limpia**

Fabriqué en acier inoxydable 18/10, il garantit résistance, durabilité et hygiène  
Garantit une séparation propre

Aus nicht rostendem 18/10-Stahl hergestellt, garantiert strapazierfähig, langlebig und hygienisch. Sorgt für saubere Trennung

Made from 18/10 stainless steel, resistance, durability and hygiene are guaranteed  
Ensures clean separation

Fabricado em aço inoxidável 18/10, que lhe oferece uma grande resistência, durabilidade e higiene  
Assegura uma separação limpa

**Separador de claras con pinza**

Séparateur à oeuf avec pince  
Eier-Separator mit Zange  
Eggs separator with long  
Separador de ovos con pinça



Ref	€	Pack
61609	9,70	1

Inox

**Molde huevo-sandwich**

Moule à oeufs-sandwich  
Eier-/Sandwichring  
Mould for egg-sandwich  
Molde ovo-Sandwich

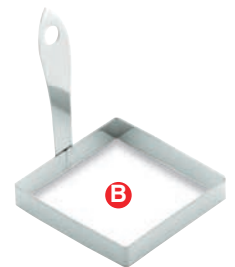

	Ref	€	cm	Pack
<b>A</b>	68005	2,50	Ø8,5	1
<b>B</b>	68006	2,50	8,5x8,5	1

SI  
Silicone230°C  
Max.**Molde huevo redondo silicona**

Moule à oeufs rond en silicone  
Silikon Eierform  
Silicone round shape egg mould  
Molde ovo redondo de silicone



Ref	€	Ø (cm)	Pack
68080	4,90	10x2	12

SI  
Silicone230°C  
Max.**Molde huevo corazón silicona**

Moule à oeufs coeur en silicone  
Silikon Herzform  
Silicone heart shape egg mould  
Molde ovo coração de silicone



Ref	€	cm	Pack
68082	4,90	10,5x10,5x2	12

**Soporte huevo OVUM**

Support d'oeufs  
Ei-Unterstützung  
Egg stand  
Suporte de ovo



Ref	€	Ø (cm)	Pack
68285	2,30	4,5x5	24

**Abridor huevos OVUM**

Oeufs ouvrir  
Eier opener  
Egg opener  
Ovos abridor



Ref	€	Ø (cm)	Pack
68286	10,10	4,5x5,5	24



## Jarras medidoras · Calderos



**Jarra 5 litros**  
Pot en inox 5 L  
Wasserkanne 5 L  
5 L.pitcher  
Jarra 5 L



**Jarra de medidas cónica**  
Pot mesureur  
Mass Behälter  
Measuring cup  
Jarra de medidas cónica



**Jarra medidora**  
Pot mesureur  
Mass Behälter  
Measuring jug  
Jarra de medidas



Ref.	€	Ø (cm)	L	Pack
62750	58,60	17x22,5	5,00	1

Ref.	€	L	Pack
67010	27,00	1,00	1

Ref.	€	ml	Pack
67136	3,70	500	1



**Juego 3 jarras medidoras**  
Ensemble de 3 pot mesureur  
3 tlg. satz mass behälter  
3 piece measuring jugs  
Jogo 3 jarras de medidas

Ref.	€	ml	Pack
67131	11,30	250-500-1000	1

**Jarra medidora doble**  
Double pot mesureur  
Dual Mass Behälter  
Dual measuring jug  
Jarra de medidas dupla



Ref.	€	Unidades	ml	Pack
67137	10,30	ml-oz-cup	500-100	6

**Caldero cónico con asas**  
Bassine conique à anses  
Wanne mit Griffen  
Conical mixing bowl  
Bacia cónica con asas



Ref.	€	Ø (cm)	h (cm)	L	Pack
50828	34,00	28	13,2	5,00	1
50832	37,20	32	14,5	7,00	1
50836	43,30	36	16,0	11,00	1
50840	47,60	40	18,0	15,00	1
50845	57,40	45	20,0	22,00	1
50850	69,20	50	21,0	30,00	1

**Fuente honda cónica**  
Bassine pâtisier  
Schüssel, tief, konisch  
Deep and conical dish  
Bacia alta cónica



Ref.	€	Ø (cm)	h (cm)	L	Pack
60013	9,70	13	6,1	0,55	1
60016	10,50	16	9,1	1,00	1
60020	14,50	20	11,7	2,12	1
60024	17,40	24	12,6	3,50	1
60028	21,90	28	13,4	5,25	1
60032	23,80	32	15,0	7,65	1
60036	34,00	36	16,0	11,00	1
60040	39,40	40	18,0	15,00	1

**Caldero semi-esférico con asas**  
Bassine hemispherique a/anses  
Schneeslagkessel mit Griffen  
Semi-spherical mixing bowl w/handles  
Bacia semi-esférica com asas



Ref.	€	Ø (cm)	h (cm)	L	Pack
50323	37,70	22	11,0	2,70	1
50327	42,20	26	13,0	4,00	1
50333	54,80	32	17,0	9,50	1
50337	59,10	36	18,0	12,00	1
50341	85,80	40	21,0	14,50	1

**Caldero semi-esférico sin asas**  
Bassine hemispherique s/anses  
Schneeslagkessel ohne Griffen  
Semi-spherical mixing bowl wout/handles  
Bacia semi-esférica sem asas



Ref.	€	Ø (cm)	h (cm)	L	Pack
50323S	28,70	22	11,0	2,70	1
50327S	33,30	26	13,0	4,00	1
50333S	44,70	32	17,0	9,50	1
50337S	51,20	36	18,0	12,00	1
50341S	86,30	40	21,0	14,50	1



**Bol cónico Inox 18% Cr.**

Bol conique inox 18% Cr.  
Schüssel, konisch, Edelstahl 18% Cr.  
st. steel 18% Cr. conical mixing bowl  
Bacia cónica Inóx 18% Cr.



Ref	€	Ø (cm)	h (cm)	L	Pack
14016	2,80	16	6,5	0,90	1
14019	4,00	20	7,5	1,40	1
14025	7,40	24	9,0	2,50	1
14029	9,90	30	11,0	4,30	1
14033	13,90	34	13,5	7,50	1

**Soporte de caldero s/esfericos**

Support cul de poule  
Ringständer  
Bowl stand  
Suporte de bacias semi-esféricas



Ref.	€	Pack
50300	20,10	6



**Cubo Inox 18% Cr.**

Seau Inox 18% Cr.  
Eimer, Edelstahl 18% Cr.  
Pail, St. Steel 18% Cr.  
Balde Inóx. 18% Cr.



Ref	€	Ø (cm)	h (cm)	L	Pack
14114	7,00	16-12	15,5	1,40	6
14119	13,60	20-15	20,0	4,60	6
14124	17,00	24-17,2	20,5	5,60	6
14128	31,00	28-21	25,8	14,00	6

**Cuece especias**

Diffuseur épices  
Kräuterkochsieb  
Spice cooker  
Cozedor de especiarias



Ref	€	Ø (cm)	h (cm)	Pack
62958	9,90	4	15,4	12

**Cacerola Vapor**

Panier vapeur  
Dampfkoch-Aussatz o/Untertopf  
Steam casserole  
Çaçarola a vapor



Ref	€	Ø (cm)	h (cm)	Pack
50428	46,80	28	11,0	1
50432	51,20	32	12,5	1

**Cuscusera**

Couscoussier  
Kuskustopf  
Couscous pot  
Couscouseirar



Ref	€	Ø (cm)	Ø Base	L	Pack
50437	75,50	36x16,5	28	15,0	1
50441	85,70	40x22	32	22,0	1

**Hervidor pescado**

Poissonniere avec grille  
Fischkochkessel  
Fish kettle with grill  
Peixeira



Ref.	€	cm	h (cm)	L	Pack
50440	74,60	40x19	11	10,05	1
50445	82,10	50x17	11	13,80	1
50460	107,30	60x19	11	20,80	1

**Hervidor extensible Inox**

Panier marguerite extensible en Inox  
Kocher, ausdehnbar, Rostfrei  
St steel extensible steamer  
Grelha extensível Inóx



Ref	€	Ø (cm)	Pack
60349	5,40	24	12
60348	7,90	28	12



## Escurridores

### Escurridera cónica con base

Passoire conique sur pied  
Abtropfschüssel  
Conical colander with stand  
Escorredor cónico com base



Ref	€	Ø (cm)	h (cm)	L	Pack
50829	56,00	28	17	13,2	1
50833	61,40	32	20	14,5	1
50837	70,00	36	23	16,0	1
50841	75,70	40	26	18,0	1
50846	86,80	45	29	20,0	1
50851	98,80	50	33	22,0	1

### Escurridera con base Inox

Passoire sur pied en Inox  
Abtropfschüssel mit Fussreif,Edelstahl  
S. Steel Colander with stand  
Escorredora com base inóx



Ref.	€	Ø (cm)	h (cm)	L	Pack
50332	170,10	32	18	9,5	1
50336	207,00	36	19	12,0	1
50340	244,90	40	21	14,5	1



### Escurridera Inox

Passoire Inox  
Abtropfschüssel  
Colander St. Steel  
Escorredor inóx



Ref	€	Ø (cm)	Pack
14122	14,30	22	6
14125	17,80	25	6
14130	26,00	30	6

### Escurridor extensible para fregadera

Passoire extensible pour l'évier  
Spülbank-Sieb, ausziehbar  
Extensible sink strainer  
Escorredor extensível para bancada



Ref	€	cm	Max (cm)	Pack
62987	19,10	34x24	55x24	6

Agujeros · Holes : 1x1 cm



### Escurrefritos

Passoire a friture  
Abtropfschüssel für Frittiertes  
Fry colander  
Escorre-fritos

Ref.	€	cm	h (cm)	Pack
50541	143,80	40x29	8,0	1
50551	169,60	50x39	8,0	1
50561	194,90	60x39	8,0	1

### Harinero

Tamis à farine à glissière  
Mehlbehälter  
Flour bin mesh  
Farinheiro

Ref.	€	cm	Pack
50438	129,70	18x37x26,5	1
50450	133,80	18x50x26,5	1

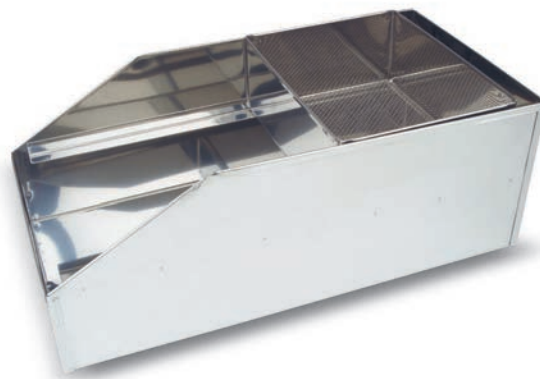



## Coladores

**Colador 4 sectores**

Passoire avec 4 segments  
4 Einsätze für Teigwaren  
4 segmented colander  
Coador 4 sectores

Ref.	€	Ø (cm)	h (cm)	Pack
50335	230,60	36	23,0	1
50339	281,80	40	26,0	1

**Colador**

Passoire  
Teigwaren  
Colander  
Coador

Ref.	€	Ø (cm)	h (cm)	Pack
50334	57,70	36	23,0	1
50338	69,80	40	26,0	1

**Colador**

Passoire à queue  
Seiher mit Stiel  
Strainer  
Coador



Ref.	€	Ø (cm)	h (cm)	L	Pack
50320	44,60	20	12	3,5	1
50324	50,70	24	14	6,5	1
50328	59,40	28	15	9,3	1

**Colador redondo**

Passoire ronde  
Rund seiher  
Round expandable colander  
Coador redondo



SI  
Silicone

180°C  
Max.

Ref	€	Ø (cm)	L	Pack
62624	18,30	24	4,0	6

**Colador chino**

Passoire "Chinois"  
Spitzsieb mit Flachstiel  
"Chinese" strainer  
Passador chinês



Ref	€	Ø (cm)	Pack
60311	13,50	10	1
60313	13,90	12	1
60315	14,60	14	1
60317	16,10	16	1
60318	16,80	18	1
60320	18,10	20	1
60322	19,80	22	1
60324	21,00	24	1
60326	22,60	26	1

**Colador chino m/varilla c/pestaña**

Passoire "Chinois" manche fil  
Spitzsieb mit Rundstiel  
Wire handle "Chinese" strainer  
Passador chinês cabo vareta com suporte



Ref	€	Ø (cm)	Pack
60316P	13,30	16	1
60318P	14,30	18	1
60320P	15,60	20	1
60322P	17,50	22	1
60324P	18,80	24	1

**Colador chino mango varilla sin pestaña**

Passoire "Chinois" manche fil  
Spitzsieb mit Rundstiel  
Wire handle "Chinese" strainer  
Passador chinês cabo vareta sem suporte



Ref	€	Ø (cm)	Pack
60316V	13,90	16	1
60319V	15,90	20	1

**Colador chino de malla**

Passoire "Chinois" toile-metallique  
Gazespitzsieb  
Meshed "Chinese" strainer  
Coador chinês de rede



Ref	€	Ø (cm)	Pack
60319	22,40	18	1
60321	27,50	20	1
60323	28,00	22	1
60325	30,90	24	1

**Colador malla con refuerzo**

Chinois toile-metallique a croissillon  
Gewebedurchschlag, konisch, verstärkt  
Conical mesh strainer w/protection  
Coador de rede com reforço

Ref.	€	Ø (cm)	Pack
62621	40,60	20x22	1

**Mano chino**

Poussoir á chinois  
Holz-Stössel, Buche  
Chinesse strainer pusher  
Pilão p/passador chinês



Ref	€	L (cm)	Pack
60300	4,90	25	1

**Colador cónico**

Passoire conique  
Passiersieb, konisch  
Conical sieve  
Coador cónico

Ref	€	Ø (cm)	Pack
62690	5,70	8	12
62611	7,50	10	12
62613	9,60	12	12
62615	11,90	14	12
62617	14,10	16	12
62619	15,90	18	12

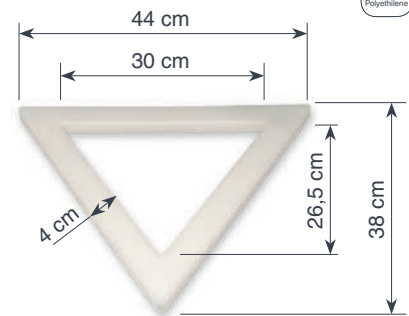
**Triangulo**

Triangle  
Dreieck  
Triangle  
Triângulo

Ref.	€	h (cm)	mm
60402	45,40	2	400

**Colador 1/2 bola**

Passe-bouillon  
Passiersieb  
Sieve  
Coador 1/2

Ref	€	Ø (cm)	Pack
62680	4,30	8	12
62610	7,10	10	12
62612	9,10	12	12
62614	10,60	14	12
62616	12,50	16	12
62618	14,60	18	12
62620	18,90	20	12
62623	22,80	23	12

**Embudo Expandible**

Entonnoir extensible  
Trichter  
Foldable funnel  
Funil extensível



Ref	€	Ø (cm)	Pack
68085	4,70	12	12

**Embudo**

Entonnoir  
Trichter  
Funnel  
Funil

Ref	€	Ø (cm)	Pack
62512	12,50	12	1
62516	18,00	16	1
62521	23,40	20	1
62524	26,20	24	1

**Embudo con filtro**

Entonnoir à filtre mobile  
Trichter mit Sieb  
Funnel with movable filter  
Funil com filtro



Ref	€	Ø (cm)	Pack
62531	10,10	10	1
62513	12,00	12	1
62515	13,90	14	1

## Pasapurés



**No falta en ninguna cocina. Utensilio de cocina muy útil y práctico  
Consigue finos y cremosos purés de hortalizas, frutas y verduras**

Indispensable dans toutes les cuisines. Ustensile de cuisine très utile et pratique  
Permet d'obtenir de fines et crémeuses purées de légumes et de fruits

Fehlt in keiner Küche. Sehr nützliches und praktisches Küchenutensil  
Zur Zubereitung von feinen und cremigen Gemüse- und Obstpürees

Every kitchen should have it. Very useful and practical kitchenware  
Achieve fine, creamy fruit and vegetable purées

Indispensável em qualquer cozinha. Um utensílio de cozinha útil e prático  
Consiga finos e cremosos purés de hortalizas, frutas e verduras

### Pasapurés Profesional 2 discos

Presse-Puree (2 disques)  
Passiergerät  
Potato mashing machine 2 discs  
Passa-puré profissional 2 discos



### Pasapurés 2 discos

Presse-puree (2 disques)  
Passiergerät 2 Scheiben  
Potato mashing machine 2 discs  
Passa-puré 2 discos



Ref.	€	Ø (cm)	L	Ø Disco (cm)	Pack
60026	98,50	26	5,0	16,5	1
60031	102,90	32	8,0	16,5	1

Ref	€	Ø (cm)	L	Ø Disco (cm)	Pack
60030	64,40	30	3,5	16,5	1

### Pasapurés 3 discos

Presse-puree (3 disq.)  
Passiergerät 3 Scheiben  
Potato mashing machine 3 discs  
Passa-puré 3 discos



### Pasapurés Doméstico 2 discos

Presse-Puree (2 disques)  
Passiergerät  
Home Potato mashing machine 2 discs  
Passa-puré doméstico 2 discos



Ref	€	Ø (cm)	L	Ø Disco (cm)	Pack
60048	42,00	18	0,7	10,5	1
60027	57,10	24	1,5	13,5	1

Ref	€	Ø (cm)	L	Ø Disco (cm)	Pack
60021	43,40	20	1,5	11,5	1

## Prensadores

### Prensa patatas

Presse-pomme de terre  
Kartoffelpresse  
Potato press  
Esmaga-batatas



Ref	€	cm	Pack
62902	27,40	9x28x11	6

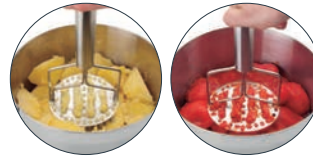

### Prensador de patatas

Presse-purée  
Kartoffelpresse  
Potato masher  
Prensa-batatas



Ref	€	cm	h (cm)	Pack
62892	15,50	10,5x8,5	24	6



### Prensa ajos y laminador

Presse ail coupe  
Knoblauchpresse, Schneider  
Garlic press and slicer  
Esmaga-alhos y laminador



Ref	€	L (cm)	Pack
60387	20,50	20	6

### Ablandacarne Inox

Attendrisseur à viande en Inox  
Fleischklopf, Edelstahl  
St. steel meat tenderizer  
Ablandacarne Inóx



Ref	€	cm	Pack
60432	29,60	12x2	1

### Martillo ablandacarne

Marteau attendrisseur de viande  
Fleischklopf Hammer  
Meat hammer tenderizer  
Martelo ablandador de carne



Ref	€	cm	Pack
60431	13,30	7x24	4



### Maza ablandacarne doble uso

Attendrisseur viande double utilisation  
Fleischklopf zweischlagflächen  
Double use meat tenderizer  
Martelo ablandador de carne dupla



Ref	€	Ø (cm)	Pack
60433	26,20	9x16	6

### Molde empanadillas

Moule à chaussons  
Pastetenformen  
Dumpling mould  
Forma para salgados



Ref	€	Ø (cm)	Pack
68101	16,60	10	6
68102	18,20	12	6



Inox



## Picadoras

**Picador MINI Inox**

Mini hachoir en Inox  
Minizerhacker, Rostfrei  
Mini st. steel chopper  
Picador Mini Inóx



Ref	€	Ø (cm)	Pack
62979	14,40	6x17	6

**Picador de cebolla**

Hachoir-oignon  
Zwiebelhacker  
Onion chopper  
Picador de cebola



Ref	€	Ø (cm)	Pack
62980	24,90	9,5x22	6

**Picaperejil**

Hachoir à manivèlle pour fines herbes  
Kräutermühle, fein, Rostfrei  
St. steel fine herbs mincer  
Pica-salsa



Ref	€	cm	Pack
60334	17,60	13,5x20x7,5	6

**Rallador Inox 2 cuchillas**

Hachoir en Inox 2 lame  
Käsereibe, 2 Schneiden, Rostfrei  
St. steel cheese grater (2 blades)  
Rallador Inóx com manivela com 2 lâminas



Ref	€	cm	Pack
60335	27,30	13,5x20x10	6

**Picadora de carne manual Inox**

Hachoir avec manivelle Inox  
Fleischwolf mit handkurbel Inox  
St. steel meat mincer  
Picadora de carne manual Inóx



Ref	€	cm	Pack
60329	99,60	17x12x19	1

**Picadora**

Mincer  
Fleischwolf  
Hachoir  
Picadora



Ref	€	cm	Pack
60340	27,20	18x22	1

## Deshojador

**New**

ABS  
Plastic

BPA free



### Deshojador de hierbas aromáticas

Effeulleuse à herbes aromatiques  
Entblätterer für gewürzkräuter  
Aromatic herb stripper  
Desfolhador de ervas aromáticas

Ref	€	cm	Pack
61359	5,20	16,5x7,5x2	6

Utensilio para facilitar la separación de las hojas del tallo y cortarlas  
Insérer el tallo en el agujero que mejor se adapte y deslizar la rama en dirección contraria

Los agujeros pequeños para deshojar hierbas aromáticas como el romero, orégano, tomillo estragón, etc.

Los agujeros más grandes para separar el tallo más duro que tienen algunas verduras de la hoja como las acelgas, espinacas, col rizada, etc.

Gracias a la parte más aguda, se pueden cortar las hojas con el mismo utensilio

Ustensile pour faciliter la séparation des feuilles de la tige et les couper  
Insérer la tige dans le trou qui s'adapte le mieux et faire glisser la branche dans le sens contraire

Les trous petits; servent à effeuiller les herbes aromatiques telles que le romarin, l'origan, le thym, l'estragon, etc.

Les trous plus grands; servent à séparer la tige plus dure de certains légumes comme les blettes, les épinards, le chou frisé, etc.

Grâce à la partie plus pointue, les feuilles peuvent être coupées avec le même ustensile

Utensil for easily separating leaves from stalks and cutting them

Put the stalk into the hole where it fits best and pull the herb in the opposite direction.

The small holes are for stripping leaves from aromatic herbs like rosemary, oregano, thyme, tarragon, etc.

The bigger holes are for separating harder stalks found in some leafy vegetables like chards, spinach, kale, etc.

With the sharp end you can use the same utensil to cut leaves

## Laminadora de pasta

### Máquina laminadora pasta

Machine Lamineuse à pâte  
Pastamaschine  
Pasta Machine Slicer  
Maquina de Pasta

	Ref	€	mm	Pack
<b>A</b>	60390	36,60	145	4
<b>B</b>	60391	67,50	260	2



### Accesorio para Ravioli

Accessoire pour Raviolis  
Zubehör für Ravioli  
Ravioli maker  
Accesório para Ravióis

	Ref	€	Columnas	Ravioli	Pack
<b>A</b>	60497	17,60	2	45x45 mm	6
<b>B</b>	60498	17,60	3	30x30 mm	6

Solo puede utilizarse en la máquina de 145 mm (Ref: 60390)  
Only can be used in the machine of 145 mm (Ref: 60390)



### Medidor de pasta Inox

Mesureur pour pâtes en Inox

Spaghetti-Mass Rostfrei

St steel pasta measurer

Medidor para macarrao en Inóx

	Ref	€	cm	Pack
<b>A</b>	62942	2,60	18	25
<b>B</b>	62943	3,60	11x9	25

Inox  
18/10

# Morteros



**Fabricados en granito de calidad Premium. Pesados y bien balanceados Interior no poroso lo que permite extraer los aceites naturales de las hierbas y especias**

Composé de granit de qualité supérieure. Lourd et bien équilibré  
Intérieur non poreux permettant d'extraire les huiles essentielles des herbes et épices

Aus Granit der Premium Qualität gefertigt. Schwer und gut balanciert  
Innenfläche nicht porös so dass ermöglicht es daher, die natürlichen Kräuter- und Gewürzöle

Manufactured from Premium quality granite. Heavy and well balanced  
Interior not porous allowing extracting natural oils from herbs and spices

Fabricado em granito de qualidade Premium. Pesado e bem equilibrado  
Interior não poroso permitindo extrair os óleos naturais das ervas e especiarias



**Mortero con mano de granito**

Mortier et pilon en granit  
Mörser und stampfe der Granit  
Granite mortar and pestles  
Argamassa e pilão do granito

	Ref	€	Ø (cm)	Pack
<b>A</b>	60512	20,70	12x8	4
<b>B</b>	60514	24,10	14x10	2
<b>C</b>	60516	25,10	16x12	2

**Mortero con mano de granito**

Mortier et pilon en granit  
Mörser und stampfe der Granit  
Granite mortar and pestles  
Argamassa e pilão do granito

	Ref	€	Ø (cm)	Pack
<b>A</b>	60517	20,00	10,5x7,5	1
<b>B</b>	60518	20,40	12x12	1



**Mortero**

Mortier  
Mörser  
Mortar  
Almofariz

Ref.	€	Ø (cm)	Pack
60403	131,90	18	1

**Mano mortero**

Poussoir à mortier  
Stößel  
Pestle  
Pilão p/almofariz



Ref.	€	Ø (cm)	Pack
60401	32,20	Ø4,8x25	1

## Botellas biberón



### Botella biberón

Bouteille biberon  
Dosierflasche  
Squeeze bottle  
Garrafa

Ref	€	Ø (cm)	L	Pack
61912	1,15	4x10	0,12	12
61925	1,20	5x19	0,25	12
61940	1,25	5,5x21,5	0,40	12
61970	1,55	7x26	0,70	12



### Botella biberón

Bouteille biberon  
Dosierflasche  
Squeeze bottle  
Garrafa

Ref	€	Ø (cm)	L	Pack
61925R	1,25	5x19	0,25	12
61940R	1,35	5,5x21,5	0,40	12
61970R	1,65	7x26	0,70	12



### Botella biberón

Bouteille biberon  
Dosierflasche  
Squeeze bottle  
Garrafa

Ref	€	Ø (cm)	L	Pack
61925A	1,25	5x19	0,25	12
61940A	1,35	5,5x21,5	0,40	12
61970A	1,65	7x26	0,70	12

Ideales para salsas, cremas, aceites, aliños, vinagretas y todo tipo de condimentos líquidos

Dibuja, adorna y personaliza con estilo tus platos, creando un efecto visual y gastronómico muy atractivo

Uso muy sencillo, cuentan con un tapón de rosca para poder introducir el aliño

Idéal pour les sauces, les crèmes, les huiles, les assaisonnements, les vinaigrettes et tout type de condiments liquides

Il dessine, décore et personnalise les plats avec style en créant un effet visuel et gastronomique très attrayant

Utilisation très simple : dispose d'un bouchon à vis pour pouvoir introduire l'assaisonnement

Ideal für Soßen, Cremes, Öle, Dressings, Vinaigretten und alle möglichen flüssigen Gewürze

Verschönern und verzieren Sie Ihre Gerichte und geben Sie ihnen Ihren persönlichen Touch, indem Sie einen äußerst attraktiven visuellen und gastronomischen Effekt erzeugen

Sehr einfache Handhabung mit Schraubverschluss, um das Gewürz einzufüllen.

Ideal for sauces, creams, oils, dressings, vinaigrettes and all kinds of liquid condiments  
Draw, decorate and personalize your dishes with style, creating a very attractive visual and gastronomic effect

Very simple to use, it features a screw cap for pouring in the dressing

Ideais para molhos, cremes, óleos e azeites, temperos, vinagretas e todo o tipo de condimentos líquidos

Desenha, decora e personaliza com estilo os teus pratos, criando um efeito visual e gastronómico espetacular

Fácil de utilizar, com tampão de rosca para introduzir o tempero

SIN BISPHENOL A  
Without Bisphenol A



New

PE  
Polyethylene

PELD  
Polyethylene



### Botella biberón con boquilla triple

Bouteille biberon avec douille triple  
Dosierflasche mit Dreifachdüse  
Squeeze bottle with triple nozzle  
Garrafa com boquilha tripla

Ref	€	Ø (cm)	ml	Pack
61974	2,70	7x20	472	12
61977	2,90	7x26	708	12

SI  
Silicone

SI  
Silicone

PP  
Polipropileno



### Biberón decoración

Biberon à decorer  
Dekorieren dosierflasche  
Decorating pen  
Garrafa decoração

Ref	€	Ø (cm)	ml	Pack
64457	7,00	5,5x16	140	24



2 en 1



### Biberón decoración

Biberon à decorer  
Dekorieren dosierflasche  
Decorating pen  
Garrafa decoração

Ref	€	Ø (cm)	ml	Pack
64458	7,10	5x17,5	150	6





## Pipeta · Jeringas



**Jeringa para cocina**  
Seringue pour cuisine  
Spritze Küche  
Kitchen syringe  
Seringa para cozinha



Ref	€	ml	Unidades	Pack
61418	4,70	30	ml-oz-tsp-Tbsp	6



**Inyecta salsas o especias**  
**Extrae la salsa para reducirla en la sartén**

Injecter des sauces ou des épices  
Extraire du plat afin de les réduire dans une poêle à feu vif

Sie Sossen oder Gewürzen Sie können diese auch absaugen  
Der Pfanne heiss abschwitzen

Syringe to inject sauces or spices  
Extract them to separately reduce them in a frying pan

Injetar molhos ou especiarias  
Extrair os molhos para reduzi-los numa frigideira a lume vivo

Inox

**Pipeta para salsa**  
Poire à jus  
Sossenspritze  
Sauce syringe  
Pipeta para molho



Ref	€	L (cm)	ml	Pack
61408	14,00	30	40	12



**Pipeta para salsa**  
Poire à jus  
Sossenspritze  
Sauce syringe  
Pipeta para molho



Ref	€	L (cm)	ml	Pack
61416	10,30	30	40	12

## Contenedor



**Contenedor alimentos con tapa**  
Boîte à condiments avec couvercle  
Gewürzkasten mit Deckel  
Condiments holder with lid  
Caixa condimentos com tampa

	Ref	€	cm	Cavidades	Unidad (ml)	Pack
<b>A</b>	61133	21,20	50x16x9	3	1000	1
<b>B</b>	61134	21,20	50x16x9	4	750	1
<b>C</b>	61135	21,20	50x16x9	5	600	1
<b>D</b>	61136	21,20	50x16x9	6	450	1



## Exprimidores

### Exprimidor manual Inox

Presse citron manuel  
Manuelle zitronenpresse, rostfrei  
Manual lemon reamer  
Espremedor manual Inóx



Ref	€	Ø (cm)	L	Pack
62952	14,00	10	0,15	6
62912	16,20	12	0,20	6

### Exprimidor Limón

Presse-citron  
Zitruspresse  
Lemón squeezer  
Espremedor de limão



	Ref	€	Pack
A	62945	10,40	6
B	62946	9,20	6



### Exprimidor

Presse-fruits  
Zitruspresse  
Citrus press  
Espremedor



Ref	€	cm	Pack
63912	10,10	4,5x16	10



### Exprimidor manual

Presse citron manuel  
Manuelle zitronenpresse  
Manual lemon reamer  
Espremedor manual



Ref	€	L (cm)	Pack
63915	8,80	22	1



### Exprimidor manual con vaso

Presse citron manuel avec verre  
Manuelle Zitronenpresse mit Becher  
Manual lemon reamer with glass  
Espremedor manual com copo



Ref	€	Ø (cm)	ml	Pack
60385	7,90	11x20	500	24



### Exprimidor de zumo bajo

Presse-fruits manuel  
Manuelle fruchtpresse, klein  
Manual squeezer low  
Espremedor de sumos baixo



Ref	€	cm	Pack
63913	42,60	21x18x21	1



### Exprimidor de zumo alto

Presse-fruits manuel grand  
Manuelle fruchtpresse, hoch  
Manual squeezer high  
Espremedor de sumos alto



Ref	€	cm	Pack
63914	40,00	15x19x39	1

AL  
Aluminium

# Centrifugadoras

*Práctica y cómoda  
Practical and comfortable*



### Centrifugadora Profesional

Essoreuse à salade  
Salatschleuder  
Salad spinner drier  
Centrifugadora Professional

Ref.	€	Ø (cm)	h (cm)	L	Pack
61420	167,90	32	33	12,0	1
61425	187,10	42	40	25,0	1

Gracias a su gran velocidad de centrifugado las centrifugadoras NO escurren sino que secan la verdura por completo en segundos  
**Funcionamiento muy sencillo**  
 El giro del cestillo hará que el agua se desplace fuera, dejando las verduras y vegetales secos  
**Compuesta por tapa desmontable, escurridor y bol para hacer uso también por separado**

Grâce à sa grande vitesse d'essorage essoreuse sèche complètement les légumes au lieu de simplement les essorer en quelques secondes  
 Fonctionnement très simple  
 La rotation du panier fera se déplacer l'eau vers l'extérieur, laissant ainsi les légumes secs  
 Composée d'un couvercle démontable, d'un panier de filtrage et d'un bol pouvant également être utilisé séparément

Dank der hohen Schleudergeschwindigkeit Entwässert NICHT sondern trocknet das Gemüse komplett sekundschnell getrocknet  
 Einfache Funktionsweise  
 Die Drehung des Körbchens treibt das Wasser nach außen und trocknet Gemüse und pflanzliche Erzeugnisse  
 Bestehend aus einem abnehmbaren Deckel, Abtropfsieb und Gefäß, die auch getrennt verwendbar sind

Thanks to its high centrifugal speed the kreisels NO drips and completely dries the vegetables in seconds  
 Very easy to operate  
 The rotation of the basket causes the water to exit, leaving the vegetables dry  
 Includes a removable lid, colander and bowl that can be used separately



*700 r.p.m.*



A sua grande velocidade de centrifugação as centrifugadora secan completamente a verdura, sem a escorrer em segundos  
**Funcionamiento simples**  
 A rotação do cesto faz com que a água se desloque para fora, deixando as verduras e os vegetais secos  
 Inclui tampa desmontável, escorredor e taça que se podem utilizar por separado

*3 en 1*

Centrifugadora	Essoreuse	Kreisel	Spinner	Centrifugadora
Escurridor	Passoire	Abtropfschüssel	Colander	Escurridor
Ensaladera	Saladier	Salatschüssel	Salad bowl	Saladeira

### Centrifugadora WHITE

Essoreuse  
Kreisel  
Spinner  
Centrifugadora

Ref	€	Ø (cm)	L	Pack
61403	23,50	26x20	5,00	1

### Centrifugadora

Essoreuse  
Kreisel  
Spinner  
Centrifugadora

Ref	€	Ø (cm)	L	Pack
61404	62,40	24	4,00	1

Inox



**Doble uso** · Double utilisation  
Doppelter gebrauch  
Double use · Duplo uso

Inox



### Centrifugadora Inox

Essoreuse en Inox  
Salatschleuder, Rostfrei  
St. Steel Spinner  
Centrifugadora Inóx

Ref	€	Ø (cm)	L	Pack
61405	76,30	24	4,50	1

## Dosificador

**Cono de acero inoxidable 18/10, excelente resistencia a la corrosión, los ácidos alimentarios y sales. Capacidad 2 L**  
**Soporte mango con sistema de gatillo para un caudal ajustable**  
**Base con mucha estabilidad y fácil desmontaje para una cómoda y sencilla limpieza**  
**Contiene una válvula y 3 boquillas para que las cremas y salsas fluyan en menor o mayor cantidad tanto calientes como frías**

Cône en acier inoxydable 18/10, excellente résistance à la corrosion ainsi qu'aux acides et sels alimentaires. Capacité 2 L  
 Supporte manche avec système de gâchette pour un débit ajustable  
 Base d'une très grande stabilité et facile à démonter pour un nettoyage simple et pratique  
 Contient une valve et 3 embouts pour que les crèmes et les sauces, aussi bien chaudes que froides, coulent en quantité plus ou moins importante

Konus aus Edelstahl 18/10, besonders widerstandsfähig gegen Korrosion, Lebensmittelsäuren und Salze. Kapazität 2 L  
 Griff mit Abzug für einen regulierbaren Durchflussmesser  
 Stabile und einfach auseinandernehmbare Halterung für eine bequeme und einfache Reinigung  
 Beinhaltet ein Ventil und 3 Tüllen damit Cremes und Saucen, sowohl kalte als auch warme, in kleinerer oder größerer Menge fließen

18/10 stainless steel cone, excellent resistance to corrosion, food acids and salts. 2 litre capacity  
 Support handle with trigger system for an adjustable flow  
 Base offers great stability and easy disassembly for convenient and easy cleaning  
 Contains a valve and 3 nozzles so that hot and cold creams and sauces flow in greater or lesser quantities

Cone em aço inoxidável 18/10, com excelente resistência à corrosão, aos ácidos alimentares e aos sais. Capacidade para 2 litros  
 Suporte com mango com sistema de gatilho, para um caudal ajustável  
 Base com grande estabilidade e fácil de desmontar, para uma limpeza fácil e cómoda  
 Contém uma válvula e 3 boquilhas para dosar com precisão a quantidade de cremes e molhos, quentes ou frios



**Consigue la mejor presentación en el emplatado**  
 Helps you achieve the best presentation when plating up

**Ideal para rellenar, verter et décorar**  
 Ideal for filling, pouring and decorating

*Diseño premiado en certámenes internacionales*

*International award-winning flow  
 Good Design 2003 International Industrial  
 Graphic Design Competition The Chicago Athenaeum*



**Dosificador**  
 Entonnoir à décor  
 Dosierer  
 Portionner  
 Dosificador

Ref.	€	L	Pack
67000	72,00	2,00	1

### Cono Inox 18/10

Cône  
 Trichter  
 Cone  
 Cone Inóx 18/10

Ref.	€	L	Pack
R67000	32,00	2,00	1



### Soporte mango

Supporte  
 Stütze  
 Support  
 Suporte cabo

Ref.	€	Pack
R67001	28,80	1



### Base negra

Base noire  
 Ständer, schwarz  
 Black base  
 Base negra

Ref.	€	Pack
R67002	11,30	1



### Boquillas

Douille  
 Düse  
 Nozzle  
 Boquilhas

	Ref.	€	Ø (mm)	Pack
<b>A</b>	R67003	1,30	1	1
<b>B</b>	R67004	1,50	4	1
<b>C</b>	R67005	1,50	6	1
<b>D</b>	R67006	1,50	8	1

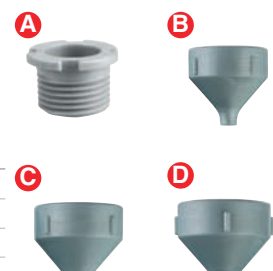



## Sifones

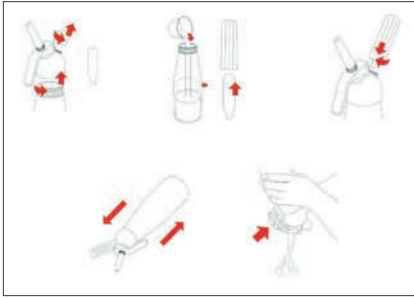

**APTO SOLAMENTE PARA MEZCLAS FRIAS Y TEMPLADAS (<50°C)**  
 À UTILISER UNIQUEMENT POUR LES MÉLANGES FROIDS ET TREMPÉS (<50°C)  
 ONLY SUITABLE FOR COLD AND TEMPERED MIXTURES (<50°C)



**Realice en segundos purés, mousses, cremas montadas, espumas, salsas y deliciosos postres, un toque de elegancia en la cocina. Ofrece 4 veces más volumen que el volumen líquido.**

**NO debe ser empleado con líquidos calientes. NUNCA ponga los sifones al baño maría, puede producirse una explosión con graves consecuencias**

Réalisez en quelques secondes des purées, des mousses, des crèmes montées, des sauces et de délicieux desserts, une touche d'élegance dans la cuisine. Confère 4 fois plus de volume que le volume liquide

**NE DOIT PAS** être utilisé avec des liquides chauds. **NE JAMAIS** mettre les siphons au bain marie car une explosion pourrait avoir lieu et provoquer de graves conséquences

Pürees, Mousses, Schlagsahne, Schäume, Saucen und köstliche Desserts im Nu zubereiten, ein Hauch von Eleganz in der Küche Vervielfacht das Ausgangsvolumen der Flüssigkeit **NICHT** für Verwendung mit heißen Flüssigkeiten geeignet. Gerät **NIE** in Wasserbad legen. Dies kann zu einer folgenschweren Explosion führen

Make purées, mousses, whipped creams, foams, sauces and delicious desserts in seconds. A touch of elegance in the kitchen Whips content up to 4 times the liquid volume Should **NOT** be used with hot liquids. **NEVER** put siphons in a water bath, as this may cause an explosion with serious consequences

Prepare em segundos purés, mousses, cremas batidos, espumas, molhos e deliciosas sobremesas, dando um toque de elegância à sua cozinha Proporciona 4 vezes mais volume do que o volume líquido **NÃO** utilizar com líquidos quentes. **NUNCA** coloque os sifões em banho-maria, para evitar o risco de explosão com consequências graves

### Botellas sifón N2O

Cartouches N2O pour siphon  
 N2O Sahnekäsel-Packung  
 N2O cream charger  
 Botijas de sifão N2O



Ref	€	Botellas	g	Pack
68402	6,50	10	8	10
68403	15,20	24	8	24

**Cabezal** · Head: Aluminio / Aluminium  
**Botella** · Bottle: Inox



### Sifón crema.

Siphon à crème  
 Sahnebereite  
 Cream whipper  
 Sifão creme

Ref	€	L	Ø (cm)	Pack
68404	98,00	0,50	7,8x25	1
68405	112,50	1,00	9,3x32,5	1

**Temperatura de uso** · Temperatura de uso  
 min = +5°C / max = +50°C

**Cabezal** · Head: Plástico PBT / PBT Plastic  
**Botella** · Bottle: Aluminio / Aluminium



### Sifón crema

Siphon à creme  
 Sahnebereiter  
 Cream whipper  
 Sifão creme

Ref	€	Ø (cm)	L	Pack
68502	33,80	9x27	0,25	12
68500	40,10	9x31	0,50	12
68501	44,60	11x36	1,00	12

**Cabezal** · Head: Aluminio / Aluminium  
**Botella** · Bottle: Aluminio / Aluminium



### Botella sifón GREEN

Siphon à creme  
 Sahnebereiter  
 Cream whipper  
 Sifão creme

Ref	€	L	Ø (cm)	Pack
68504	42,30	0,5	7,8x27,3	12
68505	46,50	1,0	9,3x32,5	12

**Temperatura de uso** · Temperatura de uso  
 min = +5°C / max = +50°C

**Cabezal** · Head: Aluminio / Aluminium  
**Botella** · Bottle: Aluminio / Aluminium



### Botella Sifón BLACK

Siphon à creme  
 Sahnebereiter  
 Cream whipper  
 Sifão creme

Ref	€	L	Ø (cm)	Pack
68604	42,30	0,50	7,8x27,3	12
68605	46,50	1,00	9,3x32,5	12

**Temperatura de uso** · Temperatura de uso  
 min = +5°C / max = +50°C



Básculas + Termómetros  
Scales + Thermometers

#CocinaConLacor



## Básculas eléctricas



### Báscula electrónica con base cuadrada 150 Kg (20 g)

Balance professionnel électronique 150 Kgs. (20g)  
Elektronische Küchenwaage mit rechteckigem Oberteil 150 Kg (20g)  
Electronic bench scale w/square base 150 Kg (20g)  
Balança electrónica com base quadrada 150 Kg (20 g)

Ref	€	Pack
61700	941,40	1

**Plataforma inoxidable 53x44cm (21"x17")**  
**Cable conexión 230V 50 Hz**  
**Batería interna recargable (Autonomía 15 días)**  
**Cabezal orientable y abatible**  
**Cuerpo aluminio fundido**  
**Patas de apoyo regulables**  
**Visor de nivel, planitud**  
**Avisador acústico de sobrecarga**  
**Teclado intuitivo y de fácil uso**  
**Funciones de calculadora**  
**Acumulación de importes**  
**Unidades de medida (Kgs., Oz., Libras)**  
**Función de tara**  
**Libro de instrucciones en 7 idiomas**

Plateau Inoxydable 53x44 cm  
Câble connexion 230 V 50 Hz  
Batterie interne rechargeable (Autonomie 15 jours)  
Afficheur orientable et rabattable  
Corp en aluminium moulé  
Pieds réglables  
Indicateur de niveau, de planéité  
Avertisseur acoustique de surcharge  
Clavier intuitif d'utilisation facile  
Fonctions de calculatrice  
Accumulation de sommes  
Unités de mesure: (Kgs., Oz, Livres)  
Fonction de tare  
Mode d'emploi en 7 langues

Rostfrei Auflagefläche 53x44 cm  
Anschlusskable 230 V 50 Hz  
Integrierte aufladbare (Leistungsdauer 15 Tage)  
Ausrichtbarer, abnehmbarer Kopfteil  
Geräterumpf aus Aluminiumguss  
Regulierbare Stützfläche  
Nivellierung-, Planheitsanzeige  
Akustischer Warnton bei Überlastung  
Berührungsempfindliche, einfach anzuwendende Tastatur  
Rechenfunktionen  
Kumulierung mehrerer Beträge  
Gewichteinheiten: (Kgrs., Oz, Pfund)  
Tara- funktion  
Handbuch in 7 Sprachen

St. Steel platform, 53x44 cm  
230 V 50 Hz connection cable  
Rechargeable internal battery (Last 15 days)  
Retractable, swivelling head  
Cast aluminium case  
Adjustable support feet  
Level and flatness indicator  
Overload alarm  
Intelligent and easy-to-use keyboard  
Calculator functions  
Total counter  
Measurement units: (Kgrs, Oz, pounds)  
Tare function  
Instructions book in 7 languages

Plataforma inoxidável 53x44 cm  
230 V 50 Hz cabo de ligação  
Bateria interna recarregável (Autonomia 15 dias)  
Cabeça orientável e abatível  
Corpo alumínio fundido  
Patras de apoi reguláveis  
Vidor de nível, plintude  
Avisador acústico de sobrecarga  
Teclado intuitivo e de fácil uso  
Função de calculadora  
cumulação de portes  
Unidades de medida (Kgrs, Oz, pounds)  
Função de tara  
Livro de instruções em 7 idiomas

Ref	Tensión/Voltage	Tara/Tare	Dimensiones/Sizes	Peso/Weight
61700	220-240 V / 50-60 Hz	150 Kgr (20 g)	49x75x90 cm	45 Kg

CERTIF.: 89/336/ECC, 91/263/EEC, 92/31/ECC, 93/68/EEC en 50 082 - 1:1992



### Báscula electrónica con base cuadrada

Balance de cuisine électronique  
Elektronische Küchenwaage mit rechteckigem Oberteil  
Electronic scale w/square base  
Balança electrónica com base quadrada

Ref	€	Tara
61716	385,70	15kg/5g
61730	415,10	30kg/10g

**Plataforma inoxidable 30x24 cm (12"x9 1/2")**  
**Cable conexión 230V 50 Hz**  
**Batería interna recargable (Autonomía 15 días)**  
**Doble display**  
**Plataforma extraíble, fácil limpieza**  
**Patras de apoyo regulables**  
**Visor de nivel, planitud**  
**Avisador acústico de sobrecarga**  
**Teclado intuitivo y de fácil uso**  
**Funciones cambio**  
**Seis memorias programable**  
**Unidades de medida (Kgs., Oz., Libras)**  
**Función de tara**  
**Libro de instrucciones en 7 idiomas**

Plateau Inoxydable 30x24 cms. (12"x9 1/2")  
Câble connexion 230 V 50 Hz  
Batterie interne rechargeable (Autonomie 15 jours)  
Double display  
Plateau amovible, nettoyage facile  
Pieds réglables  
Indicateur de niveau, de planéité  
Avertisseur acoustique de surcharge  
Clavier intuitif d'utilisation facile  
Fonctions changement  
Six mémoire programmable  
Unités de mesure: (Kgs., Oz, Livres)  
Fonction de tare  
Mode d'emploi en 7 langues

Rostfrei Auflagefläche 30x24 cms. (12"x9 1/2")  
Anschlusskable 230 V 50 Hz  
Integrierte aufladbare (Leistungsdauer 15 Tage)  
Doppertes Display  
Abnehmbare Stützfläche einfache Reinigung  
Regulierbare Stützfläche  
Nivellierung-, Planheitsanzeige  
Akustischer Warnton bei Überlastung  
Berührungsempfindliche, einfach anzuwendende Tastatur  
Tauschfunktionen  
Sechs programmierbare Speicher  
Gewichteinheiten: (Kgrs., Oz, Pfund)  
Tara- funktion  
Handbuch in 7 Sprachen

St. Steel platform, 30x24 cms. (12"x9 1/2")  
230 V 50 Hz connection cable  
Rechargeable internal battery (Last 15 days)  
Double display  
Removable, easy-to-clean platform  
Adjustable support feet  
Level and flatness indicator  
Overload alarm  
Intelligent and easy-to-use keyboard  
Change functions  
Seis memória programável  
Measurement units: (Kgrs, Oz, pounds)  
Tare function  
Instructions book in 7 languages

Plataforma inoxidável 30x24 cms. (12"x9 1/2")  
230 V 50 Hz cabo de ligação  
Bateria interna recarregável (Autonomia 15 dias)  
Duplo avanço  
Plataforma extraível, fácil limpeza  
Patras de apoi reguláveis  
Vidor de nível, plintude  
Avisador acústico de sobrecarga  
Teclado intuitivo e de fácil uso  
Função de mudança  
Seis memória programável  
Unidades de medida (Kgrs, Oz, pounds)  
Função de tara  
Livro de instruções em 7 idiomas

Ref	Tensión/Voltage	Potencia/Power	Tara/Tare	Dimensiones/Sizes	Peso/Weight
61716	220-240 V / 50-60 Hz	0,2 W (max)	15 Kgr (5 g)	30x32x12 cm	4,60 Kg
61730	220-240 V / 50-60 Hz	0,2 W (max)	30 Kgr (10 g)	30x32x12 cm	4,60 Kg

CERTIF.: OIML R76 Clase III, 60/384/ECC

## Básculas



### Báscula de cocina analógica de diseño retro

**Bol de acero inoxidable desmontable, muy fácil de limpiar (2 L)**

**Unidades de peso: Kilogramo/gramo. Capacidad máxima de 5 Kg. Precisión de 20 g**

Balance de cuisine analogique au design rétro

Bol en acier inoxydable démontable, donc très facile à nettoyer (2L)

Unités de poids : kilogramme/gramme. Capacité maximale de 5 kg. Précision de 20 g

Analoge Küchenwaage mit Retro-Design

Abnehmbare Schale aus rostfreiem Stahl, daher sehr leicht zu reinigen (2L)

Wiegeeinheiten: Kilogramm/Gramm. Höchstkapazität 5 kg. Präzision 20 g

Retro-design analogue kitchen scale

Detachable stainless steel bowl, very easy to clean (2L)

Weight units: Kilogram/gram. Maximum capacity 5 kg. Precision 20 g

Balança de cozinha analógica de design retro

Taça desmontável em aço inoxidável, fácil de limpar (2L)

Unidades de peso: Quilogramas/gramas. Capacidade máxima: 5 Kg. Precisão de 20 g



### Báscula RETRO WHITE

Balance  
Küchenwaage  
Scale  
Balança



### Báscula RETRO RED

Balance  
Küchenwaage  
Scale  
Balança



Ref	€	Kg	División (g)	Ø Bol (cm)	Pack
61714	30,50	5	20	24 (21)	1

Ref	€	Kg	División (g)	Ø Bol (cm)	Pack
61718	30,50	5	20	24 (21)	1

### Báscula mecánica con bol

Balance mécanique avec plateau creux  
Mechanische Waage mit Schale  
Mechanical scale w/bowl  
Balança mecânica com bacia



Ref	€	Kg	División (g)	Ø Bol (cm)	Pack
61705	44,20	5	20	20,5x4	1
61710	45,60	10	5	26x5,5	1

### Báscula mecánica con plato

Balance mécanique avec plateau plat  
Mechanische Waage mit flachem Oberteil  
Mechanical scale w/plain top  
Balança mecânica com prato



Ref	€	Kg	División (g)	Pack
61715	66,30	15	50	1



### Báscula cocina plástico cromado

Balance de cuisine Chrome  
Küchenwaage, verchromt  
Chromed body kitchen scale  
Balança cozinha plástico cromada

Ref	€	Kg	División (g)	Pack
61702	16,30	1	5	12





**Bol extraíble**  
Bol amovible  
Abnehmbarer Schale  
Removable bowl  
Bacia removível



**Apertura y cierre deslizante**  
Ouverture et fermeture glissière  
Das Öffnen und Schließen slide  
Opening and closing slide  
Abertura e fechament deslizante

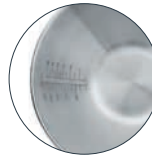

**Marcas de llenado**  
Graduation  
Füllmarken  
Filler marking  
Marcas de enchimento



**Teclado · Pantalla**  
Clavier · Ecran  
Keyboard · Bildschirm  
Keyboard · Display  
Teclado · Tela

**Báscula digital con bol extraíble**

Balance numérique avec bol amovible  
Digitalwaage mit abnehmbarer Schale  
Scale digital with removable bowl  
Balança digital con bacia removível

Ref	€	Ø (cm)	L	Kg	División (g)	Pack
61707	28,80	21 (bol)	1,50	5	1	1

**Información calórica de:**  
Information calorique de · Kalorieninformation zu  
Caloric information about · Informação de caloria

**1.800**

Alimentos · Alimentaire · Lebensmittel · Foods · Alimentos



**Equipado con un sistema de sensores de galgas extesiométricas de alta precisión**

Utiliza 4 pilas de AAA de 1,5 V  
Unidades de peso: g - Kg - oz - lb & oz  
Peso máximo: 5000g - Peso mínimo: 20 g

Equipped with a high precision strain gauge sensor system  
Used 4 batteries AAA -1,5V.  
Weight unit: g - Kg - oz - lb & oz  
Max. weight: 5000 g - Min. weight: 20 g



**Báscula electrónica de uso dietético**

Balance électronique à usage diététique  
Elektronische Diätwaage  
Electronic scales for dietetic use  
Balança electrónica de uso dietético

Ref	€	Kg	División (g)	cm	Pack
61706	45,90	5	1	17x25x2,5	1

**Apagado automático**

Tras 3 minutos sin uso, la báscula se apaga automáticamente  
Capacidad; 5 kg, el peso máximo a medir no deberá exceder 115% de la capacidad específica de la báscula  
Detección de nivel bajo de batería  
Seleccionado por el usuario

Auto power off  
When nobody use the scale after 3 minutes, then, the scale turn off automatically  
Capacity: 5kg, the total weight under measurement still cannot exceed 115% of the specified capacity of the scale  
Low battery detection. It is user selectable



**Báscula de cocina electrónica**

Balance de cuisine électronique  
Elektronische Küchenwaage  
Electronic kitchen scale  
Balança cozinha electrónica

Ref	€	Kg	División (g)	cm	Pack
61703	49,70	5	1	15,5x12	6

**Báscula electrónica**

Balance Électronique  
Elektronische Küchenwaage  
Electronic scale  
Balança Electrónica



Ref	€	Kg	División (g)	Ø Cristal (cm)	Pack
61735	30,60	5	1	18	10

**Báscula sobremesa cristal**

Balance électronique pour cuisine  
ElektronischeKüchenwaage  
Electronic kitchen scale  
Balança sobremesa em vidro

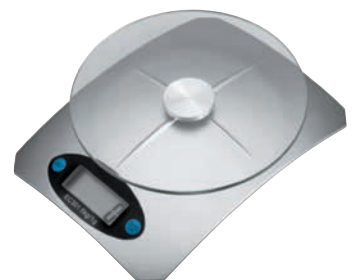

Ref	€	Kg	División (g)	Pack
61725	18,40	5	1	1

**Báscula digital**

Balance numérique  
Digital Küchenwaage  
Digital scale  
Balança digital



Ref	€	Kg	División (g)	Base	Pack
61746	54,30	5	1	17,7x17,7	1

**Báscula eléctrica**

Balance électrique  
Elektrische Küchenwaage  
Electric scale  
Balança eléctrica



Ref	€	Kg	División (g)	cm	Unidades	Pack
61708	22,10	5	1	27x18x4	gr/oz/ml/cups	10

**Cuchara medidora digital**

Cuillère avec Balance Digital  
Digitale Löffelwaage  
Digital spoon scale  
Colher de pesar Digital



Ref	€	g	División (g)	L (cm)	Pack
62519	32,30	300	0,10	28	6

**Báscula de precisión de bolsillo**

Balance de précision de poche  
Tasche Präzisionswaage  
Pocket precision scale  
Balança de precificação de bolso



Ref	€	g	División (g)	Pack
61709	14,10	650	0,1	1

**Báscula con gancho**

Balance électronique avec crochet  
ElektronischeKüchenwaage mit Haken  
Electronic scale w/hook  
Balança de gancho



Ref	€	Kg	División (g)	Pack
61721	18,60	10	5	1

**Báscula con gancho PROFESIONAL**

Balance électronique avec crochet  
ElektronischeKüchenwaage mit Haken  
Electronic scale w/hook  
Balança de gancho



Ref	€	Kg	División (g)	cm	Pack
61722	59,60	150	100	32x10	16

**Báscula de baño**

Pèse personne  
Personeneage  
Bathroom scale  
Escala de banheiro



Ref	€	Kg	División (Kg)	cm	Unidades	Pack
61740	25,90	180 (397lb)	0,1 (0,22lb)	31x31x4	Kg / lb	5

**Báscula de baño con base de cristal**

Pèse personne avec base en verre  
Personeneage mit einem glassockel  
Bathroom scale with glass base  
Escala de banheiro base de vidro



Ref	€	Kg	División (Kg)	cm	Unidades	Pack
61741	34,60	200 (441lb)	0,1 (0,22lb)	32x32x4	Kg / lb	5

# Termómetros

## Termómetro horno con base

Thermometre avec base pour four  
Backofen-Thermometer mit Ständer (mit halter)  
Oven thermometer with base  
Termómetro forno com base

300°C (180°F)  
50°C (122°F)



Ref	€	Pack
62454	7,90	12

## Termómetro refrigerador con base

Thermometre avec base pour refrigerateur  
Külschrank-Thermometer mit Ständer (mit halter)  
Refrigerator thermometer with base  
Termómetro refrigerador com base

30°C (86°F)  
-30°C (22°F)



Ref	€	Pack
62450	6,20	12

## Termómetro carne

Thermometre à cadran avec sonde pour viande  
Fleisch-Thermometer  
Meat thermometer  
Termómetro de carne

88°C (190°F)  
-54°C (65°F)



Ref	€	L (cm)	Pack
62452	6,80	11	12

## Termómetro analógico de aceite

Thermometre analogique de huile  
Analog Thermometer für Öl)  
Oil analogic thermometer  
Termómetro analógico óleo

Ref	€	cm	Pack
62495	10,30	5x30,5	1



30°C (86°F)  
-30°C (22°F)



300°C (572°F)  
0°C (32°F)

## Termómetro Digital con alarma

Thermomètre numérique avec Alarme  
Digital Thermometer mit Alarm  
Digital thermometer with Alarm  
Termómetro Digital con Alarme

Ref	€	Ø (cm)	Pack
62487	24,80	5x23	6



## Termómetro multiusos con alarma

Thermomètre multi-usages avec alarme  
Mehrweg thermometer mit wecker  
Multipurpose thermometer with alarme  
termómetro multiusos com alarme

Ref	€	L (cm)	Pack
62489	32,40	41,50	12



150°C (302°F)  
-40°C (40°F)

## Termómetro electrónico carne

Thermometre Electronique a/sonde pour viande  
Fleisch - Thermometer, Elektronisch  
Electronic meat thermometer  
Termómetro electrónico de carne

Ref	€	L (mm)	Pack
62453	16,90	150	12



230°C (446°F)   
-40°C (40°F)

## Termómetro electrónico

Thermometre Electronique  
Electric Thermometer  
Thermometer, Elektronisch  
Termómetro Electrónico

Ref	€	Pack
62459	17,10	6

300°C (572°F)  
-50°C (58°F)



**Espátula silicona con termómetro sonda**

Spatule en silicone avec Thermometre sonde  
Teigschaber mit Thermometer Messfühler  
Silicone spatula with Thermometer probe  
Espátula silicone com Termómetro sonda

Ref	€	L (cm)	Pack
62500	13,00	29	12

300°C (572°F)  
-50°C (58°F)



**Cuchara silicona con termómetro sonda**

Cuillère en silicone avec Thermometre sonde  
Digikonlöffel mit Thermometer Messfühler  
Silicone spoon with Thermometer probe  
Colher silicone com Termómetro sonda

Ref	€	L (cm)	Pack
62528	14,00	29	12

**La lente debería mantenerse limpia en todo momento  
No gire la sonda en dirección errónea**

La lentille devrait être à tout moment  
No tournez pas la sonde dans la  
mauvaise direction

Die Linse sollte stets sauber gehalten  
werden  
Den Messfühler ningt verdrehen oder in  
die falsche Richtung ausrichten

The lens should be kept clean at all times  
Do not twist the probe and rotate the  
probe in wrong direction

A lente deverá manter-se sempre limpa  
Não aponte a sonda em direcção errada

220°C (428°F) 230°C (452°F) 300°C (572°F)  
-33°C (27°F) -40°C (40°F) 0°C (32°F)  
SONDA

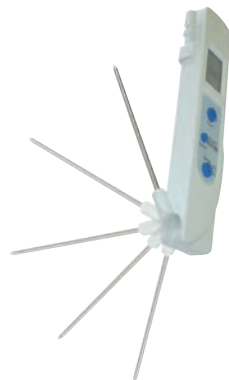

**Termómetro DUAL Infrarrojos - Sonda**

Thermomètre Dual Infrarouge - Sonde  
Dual Thermometer Infrarot - Kältesonde  
Dual Thermometer Infrared - Probe  
Termómetro duplo infravermelhos - Sonda

Ref	€	Pack
62458	85,80	1

**Base magnética para fijación sobre superficies metálicas**

Base magnétique pour fixation sur  
de superficies métalliques

Magnetische Unterseite zum  
befestigen auf metallobenfache

Magnetic base to fix metal  
surfaces

Base magnética para fixação  
sobre superficies metálicas

300°C (572°F)  
0°C (32°F)



**Termómetro Digital horno con sonda**

Thermomètre Numérique pour le four avec sonde  
Digital Thermometer des ofens mit Messfühler  
Oven Digital Thermometer with probe  
Termómetro digital forno com sonda

Ref	€	cm	Pack
62498	40,70	12x7,5	1

**NUNCA APUNTE CON EL DISPOSITIVO LOS OJOS DE ALGUIEN**

He jamais pointer l'instrument vers les yeux de quelqu'un  
Das gerät niemals auf augen von personen richten  
Never point the device towards anyone's eyes  
Nunca aponte o aparelho aos olhos de alguém



400°C (752°F)  
-50°C (58°F)



**Termómetro Infrarrojos puntero laser y funda**

Therm. mesure de surface par infra rouge a/visée  
Laser et son étui  
Infrarot Thermometer mit Lichtzeiger/Hülle  
Infrared Thermometer W/Laser Pointer/Pouch  
Termómetro infravermelhos ponta laser e interior

Ref	€	Pack
62457	101,80	6

**Base magnética para fijación sobre superficies metálicas**

Base magnétique pour fixation sur  
de superficies métalliques

Magnetische Unterseite zum  
befestigen auf metallobenfache

Magnetic base to fix metal  
surfaces

Base magnética para fixação  
sobre superficies metálicas

300°C (572°F)  
0°C (32°F)

**Doble pantalla para nevera y congelador  
Base magnética**

Double écran pour réfrigérateur  
et congélateur  
Base magnétique

Doppelanzeige für Kühlschrank  
und Gefrierschrank  
Magnetische Unterseite

Double screen for fridge and freezer  
Magnetic base

Dupla parede, para frigorífico  
e congelador  
Base magnética

70°C (158°F) 0°C (32°F)  
0°C (32°F) -40°C (40°F)



**Termómetro alarma para nevera/congelador**

Thermomètre alarme de réfrigérateur/congélateur  
Thermometer, m/Alarm f/Kühlschrank/Gefrierfach  
Fridge/Freezer Alarm Thermometer  
Termómetro alarme para refrigerador/congelador

Ref	€	Pack
62456	31,30	1



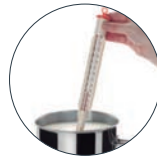

**Alcance la temperatura deseada**  
**Escala de temperatura en grados Celsius**  
**Protector de plástico**

Atteint la température souhaitée  
 Échelle de température en degrés Celsius  
 Protecteur en plastique

Die gewünschte Temperatur erreicht  
 Temperaturskala in Grad Celsius  
 Kunststoff-Schutzfolie

Reaches the desired temperature  
 Celsius temperature scale  
 Plastic protector

Atinge a temperatura desejada  
 Escala de temperatura em graus Celsius  
 Protetor de plástico



**Termómetro de leche**

Thermomètre à lait  
 Milch Thermometer  
 Milk thermometer  
 Termômetro de leite

Ref	€	L (cm)	T°	Unidad	Pack
62532	9,70	26,5	-10°C/110°C	°C	10



**Ideal para medir las temperaturas de cocción (azúcar, caramelo, mermelada, etc...)**  
**Escalas de temperatura en grados Celsius y Fahrenheit**  
**Clip de sujeción (Cacerolas) y bola de madera para un fácil manejo**  
**Funda de protección incluida**

Idéal pour mesurer les températures de cuisson (sucre, bonbons, confitures, etc.)  
 Échelles de température en degrés Celsius et Fahrenheit  
 Clip de fixation (Faitout) et boule en bois pour une utilisation aisée  
 Couverture de protection incluse

Idéal zur Messung der Temperaturen der Koch (Zucker, Süßigkeiten, Marmelade, usw.)  
 Temperaturskala in Grad Celsius und Fahrenheit  
 Halteclip ( Bratentopf) und Holzkugel zur leichten Bedienung  
 Einschließlich Schutzetui

Idéal for measuring the temperatures of cooking (sugar, candy, jam, etc.)  
 Celsius and Fahrenheit temperature scales  
 Hanging clip (Casserole) and wooden ball for easy handling  
 Protective cover included

Idéal para medir as temperaturas de cozimento (açúcar, doces, compotas, etc.)  
 Escalas de temperatura em graus Celsius e Fahrenheit  
 Clipe de fixação (Caçarolas) e bola de madeira para um fácil manuseio  
 Cobertura de proteção incluído



**Termómetro de azúcar**

Thermomètre à sucre  
 Zuckerthermometer  
 Sugar thermometer  
 Termômetro de açúcar

Ref	€	L (cm)	T°	Unidades	Pack
62533	3,80	21,5	200°C (400°F)	°C / °F	10

## Relojes



**Gracias a su parte posterior magnética podrá colocar el reloj de cocina en cualquier parte metálica de su cocina**  
**Alarma acústica programable**

Grâce à sa partie arrière magnétique, le minuteur peut être placé sur n'importe quelle partie métallique de la cuisine  
 Alarme acoustique programmable

Dank der magnetischen Rückseite kann die Küchenuhr an jede metalische Oberfläche in Ihrer Küche angebracht werden  
 Programmierbarer akustischer alarm

Thanks to the magnet on the back, the kitchen timer can be placed on any metal surface in the kitchen  
 Programmable acoustics alarm

Graças à sua parte posterior magnética, poderá colocar o relógio de cozinha em qualquer parte metálica da sua cozinha  
 Alarme sonoro programável



### Reloj de cocina magnético

Minuteur de cuisine magnetique  
 KMagnetküchentimer  
 magnetic kitchen timer  
 Relógio de cozinha magnetico

Ref	€	Tiempo	cm	Pack
60803	8,70	60 min.	9,2x3,5	12

*Resistente al agua*  
*Water resistance*

12  
Hours

IP65

99:99:99

### Reloj de cocina con alarma

Minuteur de Cuisine avec Alarme  
 Küchen-Zeitschaltuhr mit Alarm  
 Kitchen Timer Alarm  
 Relógio de cozinha com alarme



Ref	€	cm	Pack
60804	30,20	13x24,5x2,5	1



### Reloj Digital de cocina con avisador acústico

Miniuter Électronique  
 Digitale Küchen-Zeitschaltuhr mit Alarm  
 Digital kitchen timer w/alarm  
 Relógio digital de cozinha com alarme acústico

Ref	€	cm
60805	7,00	10,5x7









MESA  
•  
TABLE TOP

Bandejas-Fuentes  
*Trays*

•  
Servicio Mesa  
*Table Service*

•  
Pinzas  
*Tongs*

•  
Cafetería  
*Coffee*

•  
Termos  
*Thermos*

•  
Bar-Bodega  
*Bar-Wine Cellar*



## Bandejas Inox

### Fuente Oval Inox 18% Cr.

Plat ovale, Inox 18% Cr.  
Buffet-Tablett, oval, Edelstahl 18% Cr.  
Oval dish, St. Steel 18% Cr.  
Travessa oval Inóx 18% Cr.



Ref	€	cm	Pack
61820	4,60	20x13	1
61825	6,70	25x17	1
61830	7,20	30x20	1
61835	8,90	35x23	1
61840	10,70	40x26	1
61845	12,40	45x29	1
61850	15,30	50x31	1
61871	35,40	70x45	1
61881	41,40	80x48	1

### F. Oval pulido satinado Inox 18/10

Plat ovale poli-satine, Inox 18/10  
Buffet-Tablett, oval, Edelstahl 18/10  
Oval dish satin polish, St. Steel 18/10  
Travessa oval pulido mate Inóx



Ref	€	cm	Pack
62820	6,90	20x13	1
62825	8,70	25x17	1
62830	10,80	30x20	1
62835	13,30	35x23	1
62840	17,40	40x26	1
62845	20,00	45x29	1
62850	23,70	50x31	1



### Fuente de pescado Inox 18% Cr.

Plat à poisson, Inox 18% Cr.  
Fischplatte, Edelstahl 18% Cr.  
Fish tray, St. steel 18% Cr.  
Travessa peixe Inóx 18% Cr.

Ref	€	cm	Pack
61860	22,40	60x27	1
61880	28,80	80x30	1



### Fuente redonda Inox 18% Cr.

Plat rond, Inox 18% Cr.  
Bratenplatte, rund, Edelstahl 18% Cr.  
Round serving dish, St Steel 18% Cr.  
Travessa redonda Inóx 18% Cr.

Ref	€	Ø (cm)	Pack
61831	8,80	30	1
61836	10,90	35	1

### F. Honda Oval Inox 18%Cr.

Plat à gratin ovale, Inox 18% Cr.  
Schale, oval, Edelstahl 18% Cr.  
Deep oval dish, st. Steel 18% Cr.  
Travessa funda oval Inóx 18% Cr.



Ref	€	cm	h (cm)	Pack
61828	11,10	30x20	4,5	1
61832	13,40	35x24	4,5	1
61838	16,30	40x26	4,5	1
61843	17,70	45x29	4,5	1
61848	21,30	50x31	4,7	1

### Bandeja octogonal Inox 18/10

Plateau octogonal en Inox 18/10  
Platte, achteckig, Edlestahl 18/10  
St steel 18/10 octogonal tray  
Bandeja octogonal Inóx 18/10



Ref	€	cm	Pack
65031	43,30	31x24	1
65037	51,60	37x27	1
65041	90,40	41x32	1
65046	119,90	46x36	1



### Bandeja camarero pulido satinado Inox 18/10

Plateau limonadier poli-satine, Inox 18/10  
Serviertablett, rund, Edelstahl 18/10  
Serving tray satin polish, St. Steel 18/10  
Bandeja de servir pulido mate Inóx 18/10

Ref	€	Ø (cm)	Pack
62841	22,20	40	1



### Bandeja camarero Inox 18%Cr.

Plateau limonadier en Inox 18% Cr.  
Serviertablett, rund, Edelstahl 18% Cr.  
St. steel 18% Cr. serving tray  
Bandeja de servir Inóx 18% Cr.

Ref	€	Ø (cm)	Pack
61841	16,10	40	1



**Bandeja de marisco Inox**

Plateau a fruit de mer inox.  
Platte für Seemuschel  
Sea food tray st.steel  
Bandeja de mariscos inóx



Ref	€	Ø (cm)	Pack
14027	7,70	28	6
14042	17,30	42	6
14050	27,00	50	6

**Soporte para bandeja de mariscos Inox**

Support pour plateau a fruit de mer Inox  
Ständer für Seemuschelplatte,  
Stand for sea food tray st.steel  
Suporte para bandeja de mariscos Inóx



Ref	€	Ø Sup. (cm)	Ø Inf. (cm)	h (cm)	Pack
14100	11,90	24,5	19	20	1



**Bandeja camarero Inox**

Plateau limonadier inox.  
Servierblett  
Serving tray st.steel  
Bandeja de servir Inóx



Ref	€	Ø (cm)	Pack
14135	8,00	32	1
14136	9,30	36	1
14145	15,80	45	1

**Fibreglass**



**Redonda**

Rond  
Rund  
Round  
Redonda



Ref	€	Ø (cm)	Pack
69136	12,10	36	12
69140	17,90	40	12

**Indeformables, antiadherentes, antideslizantes y muy ligeras**

Indéformables, antiadhésives, antidérapantes et très légères  
Formbeständig, Antihafversiegelt, Rutschfest und Sehr leicht  
Do not lose shape, non-stick, non-slip and very light  
Deformável, stick-slip e extremamente leve

**Rectangular**

Rectangulaire  
Rechteckig  
Rectangular  
Rectangular



Ref	€	cm	Pack
69146	20,70	36x46	12
69152	24,90	38x52	12
69156	31,70	40x56	12
69165	45,50	45x65	12

**Oval**

Ovale  
Oval  
Oval  
Oval



Ref	€	cm	Pack
69168	54,90	56x68	6

**New**

## Bandejas Pizarra

*Pizarra natural 100% · 100% natural slate*

**Totalmente artesanales, cada bandeja es única e irrepetible**  
**Ideal para la presentación de platos fríos y calientes**  
**Ofrecen un aire de modernidad, elegancia y simpleza**  
**Excelente conductor del frío y del calor**  
**Evita los cambios bruscos de temperatura para su conservación**  
**Para conservarlas brillantes y con su color natural, cada ciertos usos impregnarlas con aceite de oliva virgen extra por ambas caras y cantos**  
**Contienen tacos antideslizantes para asegurar su estabilidad**

Totalement artisanaux, chaque plateau étant unique et inimitable  
 Idéal pour la présentation de plats froids et chauds  
 Ils apportent un air de modernité, d'élégance et de simplicité  
 Excellent conducteur du froid et de la chaleur  
 Évite les changements de température brusques pour leur conservation  
 Pour conserver leur brillance et leur couleur naturelle, il faut les imprégner régulièrement d'huile d'olive vierge sur les deux côtés et sur les bords  
 Possèdent des taquets antidérapants pour assurer leur stabilité

Handgefertigte Einzelstücke  
 Ideal zum Anrichten kalter und warmer Speisen  
 Modern, schlicht und elegant  
 Hervorragende Temperaturleitfähigkeit  
 Temperaturempfindlich, nicht schnell erhitzen oder abkühlen  
 Nach längerem Gebrauch Politur aus Olivenöl zum Erhalt von Farbe und Glanz beidseitig und an den Rändern auftragen  
 Stabilisierende Antirutschunterlagen inbegriffen

Entirely handmade, every tray is unique and unreproducible  
 Perfect for presenting hot and cold dishes  
 They have an air of modernity, elegance and simplicity  
 Excellent conductor of heat and cold  
 Avoid abrupt temperature changes to prevent damage  
 After every few uses, wipe the edges and both faces thoroughly with extra virgin olive oil to preserve their brightness and natural colour  
 They have anti-slip feet to ensure stability

Totalmente artesanais, sendo cada bandeja única e irrepetível  
 Ideal para a apresentação de pratos frios e quentes  
 Com um estilo moderno, simples e elegante  
 Excelente condutor do frio e do calor  
 Evita as mudanças bruscas de temperatura, conservando melhor a temperatura dos alimentos  
 Para as conservar brilhantes e com a sua cor natural, impregná-las periodicamente com azeite virgem extra em ambas as faces e dos lados  
 Com tacos antideslizantes que asseguram uma boa estabilidade



### Bandeja cuadrada

Plateau carré  
 Serviertablett, viereckig  
 Square tray  
 Bandeja quadrada

Ref	€	cm	e (mm)	Pack
61010	2,30	10x10	0,5	12
61015	3,40	15x15	0,5	6
61019	4,00	20x20	0,5	6
61044	12,90	40x40	0,5	6

### Bandeja rectangular

Plateau rectangulare  
 Serviertablett, rechteckig  
 Rectangular tray  
 Bandeja rectangular

Ref	€	cm	e (mm)	Pack
61016	3,30	10x15	0,5	8
61021	3,90	15x20	0,5	6
61029	4,90	15x30	0,5	6
61031	6,10	20x30	0,5	6
61041	7,20	20x40	0,5	6
61051	10,10	20x50	0,5	6
61043	11,20	40x30	0,5	6
61064	22,60	60x40	0,5	6
61082	12,90	80x20	0,5	6



**Bandeja redonda**

Plateau rond  
Servierblett rund  
Round tray  
Bandeja redonda

Ref	€	Ø (cm)	e (mm)	Pack
61070	2,60	20	5	1
61071	3,90	25	5	1
61072	5,40	30	5	1
61073	7,50	35	5	1



**Bandeja óleo**

Plateau palette  
Schieferpalette  
Palette-shaped tray  
Bandeja paleta

Ref	€	cm	e (mm)	Pack
61075	7,40	30x18	5	1
61076	9,50	35x22	5	1
61077	11,50	40x25	5	1



**Bandeja ondulada**

Plateau ondulé  
Tafelplatte, gewellt  
Undulated tray  
Bandeja ondulada

Ref	€	cm	e (mm)	Pack
61085	3,80	20x10	5	1
61086	6,60	30x15	5	1
61087	10,30	35x25	5	1



**Indicador con soporte**

Indicateur avec support  
Indikator mit Standfuß  
Indicator with stand  
Indicador com suporte

Ref	€	cm	e (mm)	Pack
61088	5,00	10x5	5	1



**Indicador cuadrado**

Indicateur carré  
Indikator, viereckig  
Square indicator  
Indicador quadrado

Ref	€	cm	e (mm)	Pack
61084	3,30	5x6	3	1



**Indicador oval**

Indicateur ovale  
Indikator, Oval  
Oval indicator  
Indicador oval

Ref	€	cm	e (mm)	Pack
61074	4,50	6x7	3	1



**Set de 4 lápices para pizarra**

Ensemble de 4 crayons pour ardoise  
Set von 4 Bleistifte für schiefer  
Set of 4 pencils for slate  
Conjunto de 4 lápis para ardósia

Ref	€	Ø (cm)	h (mm)	Pack
61089	2,10	1	8	12



## Platos

**Plato de huevos Inox 18% Cr.**

Plat à oeufs inox 18% Cr.  
Eiteller, Edelstahl 18% Cr.  
Egg serving dish s. steel 18% Cr.  
Prato de ovos Inóx 18% Cr.



Ref	€	Ø (cm)	Pack
61114	3,90	14x3	1
61116	4,10	16x3	1

**Rabanera Inox 18% Cr.**

Ravier inox 18% Cr.  
Buffet/Servier-Platte Edelstahl 18% Cr.  
Appetizer dish s. steel 18% Cr.  
Pratinho Inóx 18% Cr.



Ref	€	Ø (cm)	Pack
61013	2,60	13x6	1
61017	2,70	17x8	1
61020	3,10	20x10	1

**Plato camping llano Inox 18% Cr.**

Assiette plate de camping inox 18% Cr.  
Camping Platzteller, Edelstahl 18% Cr.  
Camping dinner plate s. steel 18% Cr.  
Prato camping raso Inóx 18% Cr.



Ref	€	Ø (cm)	Pack
61121	5,60	22	1

**Plato camping hondo Inox 18% Cr.**

Assiette creuse de camping inox 18% Cr.  
Camping Teller, tief, Edelstahl 18% Cr.  
Deep camping dinner plate s. steel 18% Cr.  
Prato camping fundo Inóx 18% Cr.



Ref	€	Ø (cm)	Pack
61122	5,90	22	1

**Posabotellas Inox 18% Cr.**

Dessous de bouteille inox 18% Cr.  
Flaschenuntersetzer, Edelstahl 18% Cr.  
Bottle stand s. steel 18% Cr.  
Pousa-garrafas Inóx 18% Cr.



Ref	€	Ø (cm)	Pack
61113	3,00	13	1

**Posavasos Inox 18% Cr.**

Sous-verre inox 18% Cr.  
Glasuntersetzer, Edelstahl 18% Cr.  
Glass stand s. steel 18% Cr.  
Pousa-copos Inóx 18% Cr. / Fuentes



Ref	€	Ø (cm)	Pack
61110	2,50	10,5	1

Melamina  
Melamine  
#CocinaConLacor

## Classic



**Una completa gama en blanco y negro de 95 piezas contemporáneas Diseñadas para realizar las creaciones del Chef**

Une gamme complète en noir et blanc de 95 pièces contemporaines Conçues pour rehausser les créations du Chef

Eine komplette Serie aus 95 modernen Teilen in schwarz und weiß Bringt die Kreationen des Küchenchefs noch besser zur Geltung

Wide collection of 95 contemporary black and white pieces Designed to complete the Chef's creations

Uma completa gama em preto e branco de 95 peças contemporâneas Pensadas para realçar as criações do chef



**Portartatas**  
uérídon pâtisserie  
Kuchenplatte  
Cake stand  
Porta-tartes

Ref	€	cm	Pack
63586	25,70	33x9	4

**Bandeja rectangular WHITE**

Plateau rectangulaire  
Serviertablet, rechteckig  
Rectangular tray  
Bandeja rectangular



Ref	€	cm	Pack
63531	6,70	26x16x2	6
63532	11,20	30x22x2	6

**Bandeja rectangular BLACK**

Plateau rectangulaire  
Serviertablet, rechteckig  
Rectangular tray  
Bandeja rectangular



Ref	€	cm	Pack
63541	6,70	26x16x2	6
63542	11,20	30x22x2	6

**Bandeja rectangular WHITE**

Plateau rectangulaire  
Serviertablet, rechteckig  
Rectangular tray  
Bandeja rectangular



Ref	€	cm	Pack
63533	14,70	30x21x3	6
63534	17,20	35x21x2	6

**Bandeja rectangular BLACK**

Plateau rectangulaire  
Serviertablet, rechteckig  
Rectangular tray  
Bandeja rectangular



Ref	€	cm	Pack
63543	14,70	30x21x3	6
63544	17,20	35x21x2	6

**Bandeja rectangular WHITE**

Plateau rectangulaire  
Serviertablet, rechteckig  
Rectangular tray  
Bandeja rectangular



Ref	€	cm	Pack
63535	29,50	53x32x3	6
63536	42,70	70x30x2	3

**Bandeja rectangular BLACK**

Plateau rectangulaire  
Serviertablet, rechteckig  
Rectangular tray  
Bandeja rectangular



Ref	€	cm	Pack
63545	29,50	53x32x3	6
63546	42,70	70x30x2	3

**Bandeja Delicatessen WHITE**

Plateau delicatessen  
Schüssel delicatessen  
Delicatessen tray  
Bandeja delicatessen



Ref	€	cm	Pack
63609	2,90	9,5x9,5	6

**Bandeja Delicatessen BLACK**

Plateau delicatessen  
Schüssel delicatessen  
Delicatessen tray  
Bandeja delicatessen



Ref	€	cm	Pack
63619	2,90	9,5x9,5	6

**Fuente redonda WHITE**

Plateau rond  
Rundplatte  
Round tray  
Travessa redonda



Ref	€	Ø (cm)	Pack
63551	23,00	40x6	6
63552	30,30	44,5x6,5	6

**Fuente redonda BLACK**

Plateau rond  
Rundplatte  
Round tray  
Travessa redonda



Ref	€	Ø (cm)	Pack
63561	23,00	40x6	6
63562	30,30	44,5x6,5	6

**Fuente redonda WHITE**

Plateau rond  
Rundplatte  
Round tray  
Travessa redonda



Ref	€	Ø (cm)	Pack
63550	18,50	35,5x7,5	6

**Fuente redonda WHITE**

Plateau rond  
Rundplatte  
Round tray  
Travessa redonda



Ref	€	Ø (cm)	L	Pack
63553	12,50	22x10	2,4	6
63554	18,40	28x10	4,0	6
63555	25,70	33x13	7,0	2
63556	31,90	38x14,5	11,0	2

**Fuente oval WHITE**

Plateau oval  
Oval platte  
Oval tray  
Travessa redonda



Ref	€	cm	L	Pack
63557	7,70	32x12x6	0,85	6
63558	12,20	41,5x17x8	2,20	6

**Fuente oval BLACK**

Plateau oval  
Oval platte  
Oval tray  
Travessa redonda



Ref	€	cm	L	Pack
63567	7,70	32x12x6	0,85	6
63568	12,20	41,5x17x8	2,20	6

**Fuente cuadrada WHITE**

Plateau rectangulaire  
Serviertablet, rechteckig  
Rectangular tray  
Travessa cuadrada



Ref	€	cm	L	Pack
63573	22,40	33,5x33,5x8,5	5,0	6

**Bol redondo WHITE**

Rond bol  
Boul rund  
Bowl round  
Bacia redonda



Ref	€	Ø (cm)	L	Pack
63574	6,00	20x10	1,50	6
63575	9,60	25x11,5	2,50	6

**Fuente WHITE**

Plateau  
Serviertablet  
Tray  
Travessa



Ref	€	Ø (cm)	L	Pack
63577	21,00	35,5x11	4,0	6

**Fuente WHITE**

Plateau  
Serviertablet  
Tray  
Travessa



Ref	€	Ø (cm)	L	Pack
63578	26,70	45,5x9	2,0	6



**Fuente redonda WHITE**

Plateau rond  
Rundplatte  
Round tray  
Travessa redonda



Ref	€	Ø (cm)	L	Pack
63559	14,90	30x6,5	3,0	6

**Fuente triangular WHITE**

Platte triange  
Scüssell weis  
triangle tray  
Travessa triangular



Ref	€	cm	L	Pack
63579	13,90	25x24x11	3,0	6

**Fuente oval WHITE**

Plateau oval  
Oval platte  
Oval tray  
Travessa oval



Ref	€	cm	L	Pack
63585	18,70	29x26x16	4,0	6

**Bol redondo WHITE**

Rond bol  
Boul rund  
Bowl round  
Bacia redonda



Ref	€	Ø (cm)	L	Pack
63576	13,00	20,5x15	2,5	6

**Fuente triangular WHITE**

Platte triange  
Scüssell weis  
Triangle tray  
Travessa triangular



Ref	€	cm	Pack
63588	23,30	40,5x40,5x6,5	6

**Fuente triangular BLACK**

Platte triange  
Scüssell weis  
Triangle tray  
Travessa triangular



Ref	€	cm	Pack
63598	23,30	40,5x40,5x6,5	6

**Fuente pescado WHITE**

Plateau poisson  
Schüssel weis  
Fish tray  
Travessa peixe



Ref	€	cm	Pack
63589	24,00	57x22x4	6

**Fuente pescado BLACK**

Plateau poisson  
Schüssel weis  
Fish tray  
Travessa peixe



Ref	€	cm	Pack
63599	24,00	57x22x4	6

**Bol ensalada WHITE**

Bac salade  
Schüssel  
Salad bowl  
Bacia de salada



Ref	€	cm	L	Pack
63570	6,00	13x13x6	0,5	6
63571	15,50	19x19x9	2,0	6
63572	30,20	25x25x12	4,8	6

**Bol ensalada BLACK**

Bac salade  
Schüssel  
Salad bowl  
Bacia de salada



Ref	€	cm	L	Pack
63580	6,00	13x13x6	0,5	6
63581	15,50	19x19x9	2,0	6
63582	30,20	25x25x12	4,8	6

**Bol antideslizante WHITE**

Antidérapant bol  
Schale Anti-Rutsch  
Bowl anti-slip  
Bacia antiderrapante



Ref	€	Ø (cm)	L	Pack
63606	8,30	13x10,5	0,8	6

**Bol antideslizante WHITE**

Antidérapant bol  
Schale Anti-Rutsch  
Bowl anti-slip  
Bacia antiderrapante



Ref	€	Ø (cm)	L	Pack
63607	8,80	14,5x7	0,65	6

**Bandeja Delicatessen WHITE**

Plateau Delicatessen  
Schüssel Delicatessen  
Delicatessen tray  
Bandeja Delicatessen



Ref	€	cm	L	Pack
63610	2,50	10x10x2,5	0,12	6

**Bandeja Delicatessen BLACK**

Plateau Delicatessen  
Schüssel Delicatessen  
Delicatessen tray  
Bandeja Delicatessen



Ref	€	cm	L	Pack
63617	2,50	10x10x2,5	0,12	6

**Ribbed bol**

Ribbed bol  
Schale Ribbed  
Bowl Ribbed  
Bacia Ribbed



Ref	€	Ø (cm)	L	Pack
63611	1,80	7x3	0,05	6
63612	2,20	8,5x4	0,10	6

**Bandeja oval**

Plateau ovale  
Servierblett oval  
Oval tray  
Bandeja oval



Ref	€	mm	Pack
62751	3,10	207x144x18	10
62753	4,90	250x183x22	10
62754	5,20	280x200x24	10
62755	6,20	314x234x25	10
62756	7,60	335x258x26	10
62757	8,40	326x285x27	10
62758	11,00	412x314x28	10
62759	12,70	458x348x30	10

**Bandeja redonda**

Plateau rond  
Servierblett rund  
Round tray  
Bandeja redonda



Ref	€	Ø (mm)	Pack
62761	3,20	180x24	10
62762	3,80	200x25	10
62764	5,70	254x29	10
62766	9,40	307x33	10
62768	11,40	335x32	10
62769	16,30	400x35	10

**Plato redondo ondulado**

Plateau rond ondulé  
Rund Teller gewellt  
Undulated round plate  
Plato redondo ondulado



Ref	€	Ø (mm)	Pack
62770	4,90	207x28	10
62771	8,20	250x30	10
62772	9,70	295x31	10
62773	13,70	345x33	10

**Bandeja rectangular**

Plateau rectangulaire  
Servierblett, rechteckig  
Rectangular tray  
Bandeja rectangular



Ref	€	mm	Pack
62791	5,50	248x160x23	10
62792	7,90	280x190x23	10
62793	9,20	300x208x23	10

**Bol cuadrado**

Bac carre  
Schüssel, viereckig  
Square bowl  
Bacia quadrada



Ref	€	mm	L	Pack
62780	3,10	123x123x63	0,40	10
62781	3,70	149x149x70	0,70	10
62782	4,70	173x173x79	1,00	10
62783	6,20	197x197x88	1,50	10
62784	8,00	215x215x95	2,00	10

**Bol redondo**

Bac rond  
Schüssel, rund  
Round bowl  
Bacia refondo



Ref	€	Ø (mm)	L	Pack
62785	2,70	118x51	0,30	10
62786	3,30	128x57	0,40	10
62787	3,90	149x65	0,60	10
62789	6,50	189x80	1,30	10
62790	7,90	206x88	1,80	10



**Bandeja camarero rectangular**

Plateau limonadier rectangulaire  
Serviertablet, rechteckig  
Rectangular serving tray  
Bandeja de servir rectangular

Ref	€	mm	Pack
62797	18,50	433x293x48	1

**Cuchara lisa**

Cuillère lisse  
ServierLöffel  
Plain spoon  
Colher lisa



Ref	€	cm	Pack
63600	0,80	18	6

**Pinza multiusos WHITE**

Pince à salade  
Allzweckzange  
Multi-usage tong  
Pinça universal



ABS Plastic

Ref	€	cm	Pack
63608	2,70	22,5	6
63638	3,60	30,0	6

**Pinza multiusos BLACK**

Pince à salade  
Allzweckzange  
Multi-usage tong  
Pinça universal



ABS Plastic

Ref	€	cm	Pack
63618	2,70	22,5	6
63648	3,60	30,0	6

**Cacillo recto**

Louche sauce  
Saucengliessl  
Soup ladle  
Concha molh



Ref	€	cm	ml	Pack
63602	2,20	27	150	6

**Cacillo perforado**

Louche perforee  
Saucengliessl  
Slotted ladle  
Concha perforada



Ref	€	cm	Pack
63605	2,30	27	6

**Cuchara recta**

Louche plain  
Saucengliessl  
Plainspoon  
Colher lisaa



Ref	€	cm	ml	Pack
63601	1,40	25	40	6
63604	1,90	30	50	6

**Cuchara perforada**

Louche perforee  
Saucengliessl  
Slotted spoon  
Colher perforada



Ref	€	cm	Pack
63603	1,80	30	6

# Fuji



## Inspiradas en la cocina oriental

La armonía entre el Ying y el Yang constituyen el diseño exclusivo de la gama Fuji

Inspirées de la cuisine orientale

L'harmonie du Ying et du Yang constitue le style exclusif de la gamme Fuji

Von der asiatischen Küche inspiriert. Das Design der Fuji-Serie ist exklusiv auf Harmonie zwischen Ying und Yang gegründet

Inspired by oriental cuisine

The harmony between Ying and Yang forms the exclusive design of the Fuji range

Inspiradas na cozinha oriental

A harmonia entre Ying e Yang serve de inspiração ao design exclusivo da gama Fuji

### Fuente hoja

Palt feuille  
Bratt platte  
Leaf plate  
Travessa folha



Ref	€	cm	pack
63176	12,00	37,5x16x4	6
63177	17,60	46,5x21x6,5	6

### Fuente cuadrada

Plateau rectangulaire  
Serviertablet, rechteckig  
Rectangular tray  
Travessa quadrada



Ref	€	cm	Pack
63161	12,20	22x22x2,5	6
63162	14,10	27,5x27,5x3	6

### Bandeja rectangular

Plateau rectangulaire  
Serviertablet, rechteckig  
Rectangular tray  
Bandeja rectangular



Ref	€	cm	Pack
63164	16,90	34x21,5x2,5	6

### Bandeja rectangular

Plateau rectangulaire  
Serviertablet, rechteckig  
Rectangular tray  
Bandeja rectangular



Ref	€	cm	Pack
63163	11,40	29x18x3	6

### Fuente oval

Carrée ovale  
Schale oval  
Oval tray  
Travessa oval



Ref	€	cm	L	Pack
63166	11,60	25x19x5	0,6	6

### Bandeja rectangular

Plateau rectangulaire  
Serviertablet, rechteckig  
Rectangular tray  
Bandeja rectangular



Ref	€	cm	Pack
63165	10,50	25x15x3	6

### Fuente lagrima

Plat feuille  
Träne platte  
Tear plate  
Travessa lagrima



Ref	€	cm	Pack
63175	11,90	34x13x3	6

### Bol oval

Ovale bol  
Schale oval  
Oval tray  
Bacia oval



Ref	€	cm	L	Pack
63171	7,70	18x13,5x6	0,5	6
63172	12,30	24x17,5x8	1,0	6

### Bol oval

Ovale bol  
Schale oval  
Oval tray  
Bacia oval



Ref	€	cm	Pack
63173	5,20	14x8x4	6
63174	5,70	15x10x5	6

### Plato llano

Assiette  
Teller  
Dinner plate  
Prato raso



Ref	€	Ø (cm)	Pack
63170	15,70	30x5	6

### Cuchara snack

Cuillère snack  
Löffel snack  
Snack spoon  
Colher sbnack



Ref	€	cm	Pack
63178	3,30	14,5x14,5x4,5	6

### Bol

Bol  
Schale  
Bowl  
Bacia



Ref	€	Ø (cm)	L	Pack
63167	12,40	19,5x9	1,0	6
63168	13,50	21,5x9,5	1,5	6
63169	19,20	26x8	2,2	6



## White & Black



**Combina formas suaves y orgánicas con un diseño puro y elegante  
Piezas en color BLANCO y NEGRO, únicas y elegantes**

Allie des formes douces et organiques à un style pur et élégant  
Pièces de couleur NOIRE et BLANCHE, uniques et élégantes

Weiche natürliche Formen samt klarem und elegantem Design  
Einzigartig schön geformte Teile in SCHWARZ und WEISS

Soft and organic forms are combined with pure, stylish design  
Unique and elegant WHITE and BLACK pieces

Formas suaves e orgánicas, combinadas com um desenho de linhas puras e elegantes  
Peças em branco e negro, únicas e elegantes

### Bol redondo WHITE

Rond bol  
Boul rund  
Bowl round  
Bacia redonda



Ref	€	Ø (cm)	L	Pack
63261	7,60	17x7	0,70	6
63262	9,20	21x8	1,25	6
63263	10,30	25x8,5	1,80	6

### Bol redondo BLACK

Rond bol  
Boul rund  
Bowl round  
Bacia redonda



Ref	€	Ø (cm)	L	Pack
63361	7,60	17x7	0,70	6
63362	9,20	21x8	1,25	6
63363	10,30	25x8,5	1,80	6

### Bol redondo WHITE

Rond bol  
Boul rund  
Bowl round  
Bacia redonda



Ref	€	Ø (cm)	L	Pack
63264	6,00	12,5x7,5	0,45	6
63265	7,00	14x7,5	0,60	6
63266	9,20	18x9,5	1,25	6

### Bol redondo BLACK

Rond bol  
Boul rund  
Bowl round  
Bacia redonda



Ref	€	Ø (cm)	L	Pack
63364	6,00	12,5x7,5	0,45	6
63365	7,00	14x7,5	0,60	6
63366	9,20	18x9,5	1,25	6

### Fuente redonda WHITE

Plateau rond  
Rundplatte  
Round tray  
Travessa redonda



Ref	€	Ø (cm)	L	Pack
63267	23,50	31x8	3,0	6

### Fuente redonda BLACK

Plateau rond  
Rundplatte  
Round tray  
Travessa redonda



Ref	€	Ø (cm)	L	Pack
63367	23,50	31x8	3,0	6

### Bol redondo WHITE

Rond bol  
Boul rund  
Bowl round  
Bacia redonda



Ref	€	Ø (cm)	L	Pack
63271	11,10	21,5x11	1,80	6

### Bol redondo BLACK

Rond bol  
Boul rund  
Bowl round  
Bacia redonda



Ref	€	Ø (cm)	L	Pack
63371	11,10	21,5x11	1,80	6

**Fuente redonda WHITE**

Plateau rond  
Rundplatte  
Round tray  
Travessa redonda



Ref	€	cm	L	Pack
63268	6,10	17x14x6	0,40	6
63269	13,90	24x20x9	1,70	6

**Fuente redonda BLACK**

Plateau rond  
Rundplatte  
Round tray  
Travessa redonda



Ref	€	cm	L	Pack
63368	6,10	17x14x6	0,40	6
63369	13,90	24x20x9	1,70	6

**Fuente semicircular WHITE**

Demi-circulaire plateau  
Halbkreisförmig platte  
Semicircular tray  
Travessa semicircular



Ref	€	cm	Pack
63276	7,10	24x13x2	6

**Fuente semicircular BLACK**

Demi-circulaire plateau  
Halbkreisförmig platte  
Semicircular tray  
Travessa semicircular



Ref	€	cm	Pack
63376	7,10	24x13x2	6

**Fuente cuadrada WHITE**

Plateau carrée  
Quadratischen platte  
Square tray  
Travessa cuadrado



Ref	€	cm	Pack
63272	5,80	19x19x4	6
63273	12,60	25x25x5	6

**Fuente cuadrada BLACK**

Plateau carrée  
Quadratischen platte  
Square tray  
Travessa cuadrado



Ref	€	cm	Pack
63372	5,80	19x19x4	6
63373	12,60	25x25x5	6

**Fuente rectangular WHITE**

Plateau rectangulaire  
Serviertablet, rechteckig  
SRectangular tray  
Travessa rectangular



Ref	€	cm	Pack
63274	7,60	25x17,5x3	6

**Fuente rectangular BLACK**

Plateau rectangulaire  
Serviertablet, rechteckig  
SRectangular tray  
Travessa rectangular



Ref	€	cm	Pack
63374	7,60	25x17,5x3	6

**Fuente rectangular WHITE**

Plateau rectangulaire  
Serviertablet, rechteckig  
SRectangular tray  
Travessa rectangular



Ref	€	cm	Pack
63275	10,50	32x14x4	6

**Fuente rectangular BLACK**

Plateau rectangulaire  
Serviertablet, rechteckig  
SRectangular tray  
Travessa rectangular



Ref	€	cm	Pack
63375	10,50	32x14x4	6

**Fuente triangular WHITE**

Platte triange  
Scüssell weis  
Triangle tray  
Travessa triangular



Ref	€	cm	Pack
63277	6,50	18x18x5	6
63278	16,50	30x30x7	6

**Fuente triangular BLACK**

Platte triange  
Scüssell weis  
Triangle tray  
Travessa triangular



Ref	€	cm	Pack
63377	6,50	18x18x5	6
63378	16,50	30x30x7	6

**Fuente salsa mini WHITE**

Plateau sauce mini  
Serviertablet sauce mini  
Sauce tray mini  
Travessa molho mini



Ref	€	cm	Pack
63279	3,10	9x7x3	6

**Fuente salsa mini BLACK**

Plateau sauce mini  
Serviertablet sauce mini  
Sauce tray mini  
Travessa molho mini



Ref	€	cm	Pack
63379	3,10	9x7x3	6

**Fuente salsa WHITE**

Plateau sauce  
Serviertablet sauce  
Sauce tray  
Travessa molho



Ref	€	cm	Pack
63280	4,30	19x8x3	6

**Fuente salsa BLACK**

Plateau sauce  
Serviertablet sauce  
Sauce tray  
Travessa molho



Ref	€	cm	Pack
63380	4,30	19x8x3	6

**Bol salsa WHITE**

Bac sauce  
Schüssel saucen  
Sauce bowl  
bacia molho



Ref	€	cm	L	Pack
63270	4,60	14x12x5	0,25	6

**Bol salsa BLACK**

Bac sauce  
Schüssel saucen  
Sauce bowl  
bacia molho



Ref	€	cm	L	Pack
63370	4,60	14x12x5	0,25	6

## Pizarra



**3 piezas exclusivas, que ofrecen un aspecto de pizarra natural  
Respondiendo así a las expectativas de los Chefs más exigentes**

3 pièces exclusives, qui offrent un aspect d'ardoise naturelle  
Répondant ainsi aux attentes des Chefs les plus exigeants

3 exklusive Teile in Schieferoptik  
Erfüllt die Erwartungen der anspruchsvollsten Köche

Three exclusive pieces that offer natural slate appearance  
Which therefore meet the expectations of the most demanding Chefs

3 peças exclusivas, com aspecto de ardósia natural  
Respondem às expetativas dos chefs mais exigentes



### Fuente Pizarra

Plateau ardoise

Tafelplatte Schiefer

Slate tray

Travessa de ardósia

Ref	€	cm	Pack
63461	17,30	28x28x1	6
63462	21,90	35x28x1	6
63463	26,30	43x28x1	6



## Cubetas White & Black



**Ligeros, indeformables y apilables. Higiénicos y fácilmente lavables**  
Aptos para procesos de refrigeración, congelación o distribución de alimentos

Légères, indéformables et empilables. Hygiéniques et facilement lavables  
Compatibles pour des processus de réfrigération, congélation ou distribution d'aliments

Leicht, nicht verformbar und stapelbar. Hygienisch und einfach zu reinigen  
 Geeignet für Kühl-, Gefriervorgänge, Mikrowellenherde oder Nahrungsmittelverteilung

Light, non-deformable and stackable. Hygienic and easily washable  
 Suitable for refrigeration and freezing processes and food distribution

Leves, indeformáveis e empilháveis. Higiénicos e facilmente laváveis  
Aptos para processos de refrigeração, congelação ou distribuição de alimentos

1/1  
530 x 325 mm

### Cubeta 1/1

Bac 1/1  
GN-Behälter 1/1  
Container 1/1  
Caixa 1/1



### Cubeta 1/1

Bac 1/1  
GN-Behälter 1/1  
Container 1/1  
Caixa 1/1



Ref	€	h (mm)	L	Pack
66165E	34,70	65	8,50	3
66110E	39,30	100	13,30	3

Ref	€	h (mm)	L	Pack
66165J	37,10	65	8,50	3
66110J	41,90	100	13,30	3

1/2  
265 x 325 mm

### Cubeta 1/2

Bac 1/2  
GN-Behälter 1/2  
Container 1/2  
Caixa 1/2



### Cubeta 1/2

Bac 1/2  
GN-Behälter 1/2  
Container 1/2  
Caixa 1/2



Ref	€	h (mm)	L	Pack
66265E	18,00	65	4,50	4
66210E	20,10	100	8,00	4

Ref	€	h (mm)	L	Pack
66265J	19,00	65	4,50	4
66210J	21,60	100	8,00	4

1/3  
176 x 325 mm

### Cubeta 1/3

Bac 1/3  
GN-Behälter 1/3  
Container 1/3  
Caixa 1/3



### Cubeta 1/3

Bac 1/3  
GN-Behälter 1/3  
Container 1/3  
Caixa 1/3



Ref	€	h (mm)	L	Pack
66365E	14,10	65	2,50	6
66310E	15,70	100	3,80	6

Ref	€	h (mm)	L	Pack
66365J	15,30	65	2,50	6
66310J	16,80	100	3,80	6

1/4  
265 x 162 mm

### Cubeta 1/4

Bac 1/4  
GN-Behälter 1/4  
Container 1/4  
Caixa 1/4



### Cubeta 1/4

Bac 1/4  
GN-Behälter 1/4  
Container 1/4  
Caixa 1/4



Ref	€	h (mm)	L	Pack
66465E	12,10	65	1,90	6
66410E	13,70	100	2,50	6

Ref	€	h (mm)	L	Pack
66465J	13,00	65	1,90	6
66410J	14,80	100	2,50	6

2/3  
350 x 325 mm



**Cubeta 2/3**  
Bac 2/3  
GN-Behälter 2/3  
Container 2/3  
Caixa 2/3

Ref	€	h (mm)	L	Pack
66565E	26,00	65	5,50	6



**Cubeta 2/3**  
Bac 2/3  
GN-Behälter 2/3  
Container 2/3  
Caixa 2/3

Ref	€	h (mm)	L	Pack
66565J	27,50	65	5,50	6

1/6  
176 x 162 mm



**Cubeta 1/6**  
Bac 1/6  
GN-Behälter 1/6  
Container 1/6  
Caixa 1/6

Ref	€	h (mm)	L	Pack
66665E	8,70	65	1,10	6
66610E	9,80	100	1,60	6



**Cubeta 1/6**  
Bac 1/6  
GN-Behälter 1/6  
Container 1/6  
Caixa 1/6

Ref	€	h (mm)	L	Pack
66665J	9,40	65	1,10	6
66610J	10,50	100	1,60	6

2/4  
530 x 165 mm



**Cubeta 2/4**  
Bac 2/4  
GN-Behälter 2/4  
Container 2/4  
Caixa 2/4

Ref	€	h (mm)	L	Pack
66765E	18,10	65	4,50	6



**Cubeta 2/4**  
Bac 2/4  
GN-Behälter 2/4  
Container 2/4  
Caixa 2/4

Ref	€	h (mm)	L	Pack
66765J	18,90	65	4,50	6





Servicio Mesa  
Table Service  
#CocinaConLacor





## Mantel mesa



**Lacor completa la colección de manteles con una nueva colección de caminos de mesa**

**Perfectos para vestir las mesas de restaurantes, cafeterías y hasta el propio hogar**

**Perfectos para comidas tanto formales como informales, al aire libre, meriendas o desayunos, ya que son prácticos y cómodos**

**Mesa puesta y protegida**

**Se colocan fácilmente**

**Altamente resistentes (cosido alrededor de los bordes para evitar que se deshilache) y aislantes del calor, protegiendo la superficie superior de la mesa y protección extra contra las manchas y derrames**

**Encontrarás manteles de todos los colores, diseño y materiales, de aspecto robusto y elegante**

**Combínalos y crea una decoración en tu mesa única**

**Se limpian fácilmente con un paño húmedo o una esponja**

Lacor complète la collection de sets de table avec une nouvelle collection de chemins de table

Parfaits pour habiller les tables des restaurants, des cafétérias et même de la maison

Parfaits pour les déjeuners, les repas informels, en plein air, les goûters ou les petits déjeuners car ils sont pratiques et fonctionnels

Table dressée et protégée en quelques minutes grâce à leur facilité d'installation

De plus, ces sets de table sont très résistants (cousus autour des bords pour éviter qu'ils s'effilochent) et isolent de la chaleur, protégeant ainsi la surface supérieure de la table

De plus, ils possèdent une protection extra contre les taches et les renversements

Vous trouverez des sets de table de toutes les couleurs, styles et matériaux, avec un aspect robuste et élégant

Combinez-les et créez une décoration de table unique.

Se nettoient facilement avec un chiffon humide ou une éponge

Lacor ergänzt seine Tafelkollektion um neue Tischläufer

Ideal als Tischbedeckung für Restaurants, Cafeterias und auch für Zuhause

Ideal für Mahlzeiten, ungezwungene Einladungen, Picknick, Vesper oder Frühstück - einfach praktisch und gemütlich Schnell platzieren und schon ist der Tisch gedeckt und wird geschont Diese Sets sind außerdem sehr strapazierfähig (rundum genähter Rand verhindert Ausfransen), wärmeisolierend, und schützen die Tischplatte zusätzlich vor Flecken und Verschütten.

Tischsets in allen Farben, Formen und Materialien in robuster und eleganter Optik

Zu einzigartigen Tischdekorationen kombinierbar

Einfach mit feuchtem Lappen oder Schwamm reinigen

Lacor rounds off its tablecloth collection with a new collection of table runners

Perfect for dressing tables in restaurants, coffee shops and even your own home.

Practical and convenient, they are perfect for meals, casual dining, outdoor dining, afternoon tea or breakfast. Easy to put into place; set and protect the table in minutes. These placemats are highly resistant (sewn around the edges to prevent fraying) and heat insulating, protecting the surface of the table and providing extra protection against stains and spills.

These robust and elegant placemats are available in all colours, designs and materials. Combine them and make a decoration on your unique table.

They are easily cleaned with a damp cloth or sponge

Lacor completa a sua coleção de toalhas com uma nova coleção de caminhos de mesa

Perfeitos para vestir as mesas de restaurantes, cafeterias e o próprio lar

Práticas e cómodas, são perfeitas para os almoços e jantares, refeições informais, ao ar livre, lanches e pequenos-almoços

Fáceis de colocar, para uma mesa posta e protegida em poucos minutos

Estas toalhas são altamente resistentes (cosidas no contorno para evitar que se desfiem) e isolam do calor, protegendo a superfície da mesa e proporcionando proteção adicional contra as manchas e derrames.

No nosso catálogo encontrará toalhas com uma ampla gama de cores, desenhos e materiais, de aspecto robusto e elegante

Combine-as como quiser para criar uma decoração única para a sua mesa

Limpam-se facilmente com um pano húmido ou com uma esponja



**Fabricados en 75% PVC + 25% Polyester**

Fait de 75% PVC + 25% Polyester  
 Hergestellt aus 75% PVC + 25% Polyester  
 Made of 75% PVC + 25% Polyester  
 Feita de 75% PVC + 25% Polyester

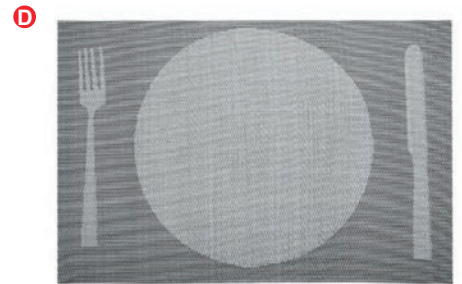
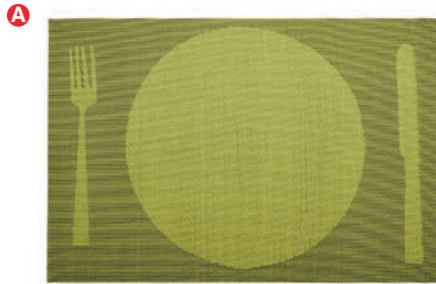

**Mantel individual**

Nappe individuel  
 Tischset  
 Individual placemat  
 Toalha de mesa individual

	Ref	€	cm	Pack	
A	66755	3,40	45x30	6	SAMUI
B	66756	3,40	45x30	6	KRABI
C	66757	3,40	45x30	6	TAPU
D	66758	3,40	45x30	6	SAMET

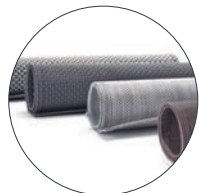

**Fabricados en 75% PVC + 25% Polyester**

Fait de 75% PVC + 25% Polyester  
 Hergestellt aus 75% PVC + 25% Polyester  
 Made of 75% PVC + 25% Polyester  
 Feita de 75% PVC + 25% Polyester

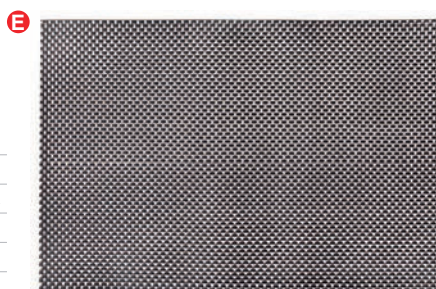

**Mantel individual**

Nappe individuel  
 Tischset  
 Individual placemat  
 Toalha de mesa individual

	Ref	€	cm	Pack	
A	66772	3,90	45x30	6	ANTA
B	66773	3,90	45x30	6	KOTAO
C	66780	3,80	45x30	6	SUMBA
D	66781	3,80	45x30	6	BIAK
E	66782	3,80	45x30	6	GI I
F	66783	3,80	45x30	6	RINCA



**Fabricados en PVC 100%**

Fait de 100% PVC  
Hergestellt aus 100% PVC  
Made of 100% PVC  
Feita de 100% PVC



**Mantel individual**

Nappe individuel  
Tischset  
Individual placemat  
Toalha de mesa individual

	Ref	€	cm	Pack	
A	66784	5,60	45x30	6	MASBATE
B	66785	5,60	45x30	6	EYTE

**Fabricados en PVC 100%**

Fait de 100% PVC  
Hergestellt aus 100% PVC  
Made of 100% PVC  
Feita de 100% PVC



**Mantel individual**

Nappe individuel  
Tischset  
Individual placemat  
Toalha de mesa individual

	Ref	€	cm	Pack	
A	66787	5,60	45x30	6	DAVAO
B	66788	5,60	45x30	6	TICAO

**New**



**Fabricados en 75% PVC + 25% Polyester**

Fait de 75% PVC + 25% Polyester  
Hergestellt aus 75% PVC + 25% Polyester  
Made of 75% PVC + 25% Polyester  
Feita de 75% PVC + 25% Polyester

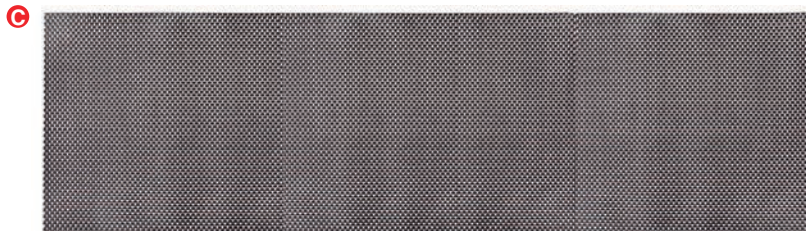

70°C max

**Camino de mesa**

Chemin de table  
Tischläufer  
Table runner  
Corre mesa

	Ref	€	cm	Pack	
A	66790	8,60	40x140	1	BORNEO
B	66791	8,60	40x140	1	MANGO E
C	66792	8,60	40x140	1	SIPURA
D	66793	8,60	40x140	1	TIMOR

## Salvamanteles



12,5x12,5 cm closed

**Salvamanteles silicona desplegable**  
dessous de plats en silicone dépliant  
Untersatz  
Silicone tablecloth foldable  
Protector de toalhas em silicone dobrável

Ref	€	cm	Pack
66752	9,20	16x16	6



**Salvamanteles**  
Dessous de plats  
Untersatz  
Tablecloth protector  
Protector de toalhas

Ref	€	cm	Pack
63008	14,90	23x23	12

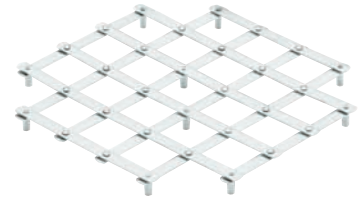

A



**Salvamanteles en silicona**  
Dessous de plats en silicone  
Untersatz, Silikon  
Silicone tablecloth protector  
Tapete silicone

	Ref	€	cm	Pack
A	66750	5,80	18x18	6
B	66751	6,60	Ø20	6

B



**Salvamanteles redondo Inox 18%Cr.**  
Dessous de plats rond Inox 18%Cr.  
Untersatz rund, Rostfrei 18%Cr  
St. steel 18%Cr. round tablecloth protector  
Protector de toalhas redondo en Inóx 18% Cr.

	Ref	€	cm	Pack
	63036	12,90	20x18x2	12



## Paneras

**Frutero - Panera Inox 18% Cr.**  
Paniere à fruit et à pain inox 18 Cr.  
Brot-/Obstkorb, Edelstahl 18 Cr.  
Fruits and bread basket s. steel 18 Cr.  
Fruteiro-Cesto Inóx 18% Cr.

	Ref	€	Ø (cm)	Pack
	61821	5,50	20	1
	61823	7,30	24	1



**Panera tela**  
Paniere en tissu  
Textil brot-/Obstkorb  
textil bread basket  
Cesta de pão têtil

	Ref	€	cm	Pack
	62948	23,20	27x12x12	4
	62949	26,60	38x19x11	4



## Paneras

Una gran gama, diseñadas para uso intensivo, elaboradas a mano y acabado en mate  
Alta resistencia y durabilidad. Apilables

Une large gamme conçue pour une utilisation intensive, fait à la main et fini mat  
Haute résistance et la durabilité. Empilable

Eine große Auswahl für den intensiven Gebrauch, handgemacht und matte Oberfläche entwickelt  
Hohe Festigkeit und Haltbarkeit. Stapelbar

A wide range designed for intensive use, handmade and matte finish  
High strength and durability. Stackable

Uma vasta gama projetado para uso intensivo, feito à mão e acabamento fosco  
Alta resistência e durabilidade. Ampilhável



### Cesta de pan redonda

Corbeille a pain ronde  
Crotkorb, rund  
Round bread basket  
Cesta de pão redonda

Ref	€	Ø (cm)	Pack
63471	6,00	19x8	12
63472	6,70	21x8	12
63473	7,20	23x8	12
63474	7,60	26x8	12



### Cesta de pan redonda

Corbeille a pain ronde  
Crotkorb, rund  
Round bread basket  
Cesta de pão redonda

Ref	€	Ø (cm)	Pack
63871	6,10	19x8	12
63872	6,70	21x8	12
63873	7,20	23x8	12
63874	7,60	26x8	12



### Cesta de pan oval

Corbeille a pain ovale  
Crotkorb, Oval  
Oval bread basket  
Cesta de pão oval

Ref	€	cm	Pack
63480	5,40	19x14x8	12
63481	6,50	24x17x8	12
63482	7,90	28x16x8,5	12



### Cesta de pan oval

Corbeille a pain ovale  
Crotkorb, Oval  
Oval bread basket  
Cesta de pão oval

Ref	€	cm	Pack
63880	5,40	19x14x8	12
63881	6,40	24x17x8	12
63882	7,80	28x16x8,5	12



### Cesta de pan cuadrada

Corbeille a pain carée  
Crotkorb, vierekig  
Aquare bread basket  
Cesta de pão quadrada

Ref	€	cm	Pack
63490	26,60	53x33,5x9	12



### Cesta de pan cuadrada

Corbeille a pain carée  
Crotkorb, vierekig  
Aquare bread basket  
Cesta de pão quadrada

Ref	€	cm	Pack
63890	26,30	53x33,5x9	12



### Cesta de pan

Corbeille a pain  
Crotkorb  
Bread basket  
Cesta de pão

Ref	€	Ø (cm)	Pack
63494	23,10	35x20	12



### Cesta de pan

Corbeille a pain  
Crotkorb  
Bread basket  
Cesta de pão

Ref	€	Ø (cm)	Pack
63894	22,80	35x20	12



## Luxe & Hiperlux



**REGULADOR: SISTEMA PATENTADO: Con dispositivo antigoteo para dosificar la cantidad a verter**

RÉGULATEUR: SYSTÈME BREVETÉ: Mini d'un dispositif antigouttes et régulateur pouvant doser la quantité à verser

REGLER: PATENTIERTES SYSTEM: Mit antitropfvorrichtung und Dosierregler

REGULATOR: PATENTED SYSTEM: With anti-drip device and regulator for controlling the amount to be poured

REGULADOR: SISTEMA PATENTEADO: Com dispositivo anti-gota e regulador para dosificar a quantidade a verter

### Juego vinagrera LUXE 4 piezas con soporte

Set vinaigriees LUXE 4 pièces socle rond

Essigkanne 4 rund LUXE

LUXE cruet set 4 pcs.

Jogo galheteiro LUXE 4 peças com suporte



### Juego vinagrera HIPERLUX 4 piezas con soporte

Set vinaigriees HIPERLUX 4 pièces socle carré

Essigkanne 4 viereckig HIPERLUX

HIPERLUX cruet set 4 pc.

Jogo galheteiro HIPERLUX 4 peças com suporte



Ref	€	ml	Pack
62464	40,20	170-30	1

Ref	€	ml	Pack
62465	41,70	200-35	1

### Juego aceitera-vinagrera LUXE con soporte

Set huilier et vinaigrier LUXE sur socle rond

Öil-Essig-Set LUXE

LUXE oil-vinegar set

Jogo azeiteira-galheteiro LUXE com suporte



### Juego aceitera-vinagrera HIPERLUX con soporte

Set huilier et vinaigrier HIPERLUX sur socle rond

Öil-Essig-Set HIPERLUX

HIPERLUX oil-vinegar set

Jogo azeiteira-galheteiro HIPERLUX com suporte



Ref	€	ml	Pack
62462	28,10	170	1

Ref	€	ml	Pack
62463	29,10	200	1

### Juego salero-Pimentero LUXE con soporte

Set sel-Poivre sur socle rond LUXE sur socle carré

Salz-Pfefferstreuer 2 viereckig LUXE

LUXE salt & pepper cruet set

Jogo saleiro e pimenteiro LUXE com suporte



### Juego salero-Pimentero HIPERLUX con soporte

Set sel et poivre HIPERLUX sur socle carré

Salz-Pfefferstreuer 2 viereckig HIPERLUX

HIPERLUX salt & pepper cruet set

Jogo saleiro e pimenteiro HIPERLUX com suporte



Ref	€	ml	Pack
62466	18,80	30	1

Ref	€	ml	Pack
62461	21,00	35	1

### Palillero redondo LUXE

Porte cure dents rond, LUXE

Zahnstocherbüchse, rund, LUXE

Round toothpick holder, LUXE

Paliteiro redondo LUXE



### Palillero cuadrado HIPERLUX

Porte cure dents carré, HIPERLUX

Zahnstocherbüchse, viereckig, HIPERLUX

Square toothpick holder, HIPERLUX

Paliteiro quadrado Hiperlux



Ref	€	ml	Pack
62470	3,50	30	6

Ref	€	ml	Pack
62469	3,80	35	6

## Basic

Inox

### Juego vinagrera

Set vinaigrie  
Menage  
Cruet set  
Jogo galheteiro

Ref	€	ml	Pack
62864	10,90	175-37,5	1



### Juego aceitera-vinagrera

Set huilier et vinaigries  
Öil-Essig-Set  
Oil-vinegar set  
Jogo azeiteira-galheteiro

Ref	€	ml	Pack
62862	8,60	175	1



### Juego Salero-Pimentero

Set calière et poiviere  
Satz-Pfeffer-Set  
Salt-Pepper set  
Jogo Saleiro-Pimenteiro

Ref	€	ml	Pack
62866	4,40	37,5	1



### Juego Salero-Pimentero-Mostaza

Set 3 pièces sel poivre moutarde  
Salz-Pfeffer-Senfkanne Set  
Salt-Pepper-Mustard set  
Saleiro-Pimenteiro-Mostarda set

Ref	€	ml	Pack
62867	7,20	37,5-150	1



## Ceramic

CE  
Ceramic

### Juego vinagrera 4 piezas

Set vinaigries 4 pièces  
Menage 4 Tlg.  
Cruet set 4 pcs.  
Jogo galheteiro 4 peças

Ref	€	ml	Pack
62384	32,20	250-100	1



### Juego aceitera-vinagrera

Set huilier et vinaigries  
Öil-Essig-Set  
Oil-vinager set  
Jogo azeiteira-galheteiro

Ref	€	ml	Pack
62382	24,10	250	1



### Juego Salero-Pimentero

Set calière et poiviere  
Satz-Pfeffer-Set  
Salt-pepper set  
Jogo saleiro-pimenteiro

Ref	€	ml	Pack
62381	11,40	100	1



## Pulverizador

### Jgo. aceitera-vinagrera Pulverizador

Set huilier et vinaigrier pulvérisateur  
Öl-Essig-Set Sprayer  
Oil-vinegar set sprayer  
Jogo azeiteira-galheteiros pulverizador



Ref	€	Ø (cm)	ml	Pack
62468	19,40	5x16	80	6

### Transforma el aceite en finísimas partículas

Permite dosificar su contenido y repartirlo uniformemente sobre los alimentos  
Muy práctico para pulverizar sobre la plancha, parrilla o sartén, creando una capa homogénea

Ahorra mucho el consumo de aceite y eso conlleva una menor ingesta de grasa y una dieta mas sana: menos aceite pero todo el sabor

Transforme l'huile en particules extrêmement fines

Permet de doser son contenu et de le répartir uniformément sur les aliments  
Très pratique pour pulvériser sur la plancha, le grill ou la poêle, créant ainsi une couche homogène

Permet une grande économie de la consommation d'huile, ce qui implique une ingestion moins importante de graisse et un régime alimentaire plus sain : moins d'huile mais toute la saveur

Verwandelt das Öl in feinste Partikel.

Ermöglicht seine Dosierung und die homogene Verteilung auf den Speisen.  
Spart den Ölverbrauch ein, sodass weniger Fett verzehrt wird für eine gesündere Diät: weniger Öl aber voller Geschmack.

Transforms the oil into very fine particles

Allows you to dose the content and distribute it evenly over food  
Very handy to spray on the griddle, grill or pan, creating an even layer  
It saves a lot of oil consumption and that leads to a lower fat intake and a healthier diet: less oil but all the flavour

Converte o óleo ou o azeite em finísimas partículas

Permite dosear o seu conteúdo e distribuí-lo uniformemente pelos alimentos  
Muito prático, para pulverizar sobre a plancha de grelhar ou na sertã, criando uma capa homogénea

Reduz o consumo de óleo e azeite, o que se traduz numa menor ingestão de gorduras, para uma dieta mais saudável. Menos óleo e azeite, conservando todo o sabor

### Pulverizador de aceite

Pulvérisateur d'huile  
Öl-Spray  
Oil Sprayer  
Pulverizador de azeite



Ref	€	Ø (cm)	ml	Pack
61908	12,50	7x18	100	6

### Pulverizador de aceite LUXE

Pulvérisateur d'huile LUXE  
Öl-Spray, LUXE  
LUXE Oil Sprayer  
Pulverizador de azeite LUXE



PC  
Polycarbon

Ref	€	Ø (cm)	ml	Pack
61901	12,30	7x20	200	6

### Aceitera - Vinagrera DUAL

Huile et vinaigries DUAL  
DUAL Öl-Essig - Dosiever  
DUAL oil-vinegar  
Azeite-galheteiro DUAL



PS  
Plastic

Ref	€	Ø (cm)	ml	Pack
61911	13,80	6x20	200	12

### Pulverizador de aceite-vinagre

Pulvérisateur d'huile et vinaigries  
Öl-Essig Spray  
Oil-vinegar bottle spray  
Pulverizador de azeite-galheteiro



PC  
Polycarbon

Ref	€	Ø (cm)	ml	Pack
61921	13,10	5,5x20	200	6

### Aceitera cónica

Huilier  
Ölkanne  
Oil can  
Azeiteira cónica



Inox  
18/10

Ref	€	L	h (cm)	Pack
62525	22,70	0,25	10,0	6
62555	34,10	0,50	19,0	4
62551	41,90	1,00	23,0	4

# Aliño

## Dosificador-Medidor de aceite

Doseur distributeur à huile  
Dispenser und Öl anzeige  
Oil portionner-measurer  
Distribuidor-manómetro de óleo

Ref	€	Ø (cm)	ml	Pack
62252	17,20	7,8x23	250	1



**Pulsar**  
Appuyez  
Drücken  
Press  
Impresa

C  
Crystal / Glass



**Medir**  
Mesure  
Ermessen  
Measure  
Medir



**Verter**  
Verser  
Gießen  
Empty  
Vazio

## Botella preparación aliño

Mélangeur  
Flasche vorbereitung verzierung  
Dressing mixer bottle  
Garrafa de preparação alino

Ref	€	Ø (cm)	ml	Pack
61918	9,30	6,5x21	300	12



**Añadir los ingredientes**  
Ajouter des ingrédients  
Zutaten hinzufügen  
Add ingredients  
Adicionar ingredientes

ASA  
Acrylic



**Agitar la botella**  
Agiter le bouteille  
Schütteln Sie die Flasche  
Shake the bottle  
Agitar o garrafa



**Verter el aliño**  
Verser la vinaigrette  
Gießen Dressing  
Slop dressing  
Derramar molho

## Aceitera aromatizadora

Huillier diffuseur d'arôme  
Aroma-Ölkanne  
Flavouring oil dispenser  
Dispensador azeite aromatizador

Ref	€	ml	Pack
61920	12,80	160	6

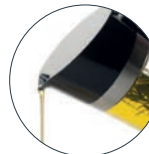

**Dispensador antigoteo**  
Verseur anti-goutte  
Antitropf -Spender  
Anti-drip dispenser  
Dispensador antigotejamento



**Sistema infusor para agregar sabor al aceite**  
Système infusoire pour ajouter du goût à l'huile  
Infuser-System zur Ölaromatisierung  
Infusion system to add flavour to the oil  
Sistema de infusão para agregar sabor ao óleo

PMMA  
Plastic

## Jarra separadora grasas

Séparateur de graisse  
Fettabscheider  
Gravy/fat separator  
Separador de gorduras

Ref	€	ml	Unidades	Pack
61610	5,10	500	ml-oz-cup	4



**Filtro resistente al calor**  
Filtre résistant à la chaleur  
Hitzebeständigen Filter  
Heat-resistant filter  
Filtro resistente ao calor

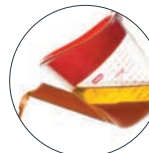

**Tres sistemas de medición (ml-oz-cup/tazas)**  
Trois systèmes de mesure (ml-oz-cups/tasses)  
Drei Messsysteme (ml-oz-cups/Tassen)  
Three systems of measurement (ml-oz-cups)  
Três sistemas de medição (ml-oz-cups/chávenas)

PS  
Polystyrene



## Especieros

Capacidad · Capacity: 100 gr



C  
Cristal / Glass

### Juego de especieros

Set à épices  
Spiel der Gewürze  
Spices set  
Jogo especiarias

Ref	€	cm	ml	Pack
61919	18,90	22x8x15	100	8

### Azucarero plástico

Saupoudreuse à sucre corps transparent  
Zuckerstreuer, transparent  
Transparent sugar shaker  
Acucareiro plástico

Ref	€	Ø (cm)	h (cm)	Pack
61904	9,90	7	12,5	6



### Salero plástico

Salière corps transparent  
Salzstreuer, transparent  
Transparent salt shaker  
Saleiro plástico

Ref	€	Ø (cm)	h (cm)	Pack
61907	8,70	7	12,5	6



### Pimentero plástico

Poivrière corps transparent  
Pfefferstreuer, transparent  
Transparent pepper shaker  
Pimenteiro plástico

Ref	€	Ø (cm)	h (cm)	Pack
61903	8,60	7	12,5	6



### Especiero queso rayado plástico

Saupoudreuse à fromage corps transparent  
Käsestreuer, transparent  
Transparent cheese shaker  
Polvilhadoqueijo ralado plástico

Ref	€	Ø (cm)	h (cm)	Pack
61905	8,60	7	12,5	6



### Especiero malla plástico

Saupoudreuse à maille fine corps transparent  
Mehlstreuer, transparent  
Transparent mesh shaker  
Polvilhador rede plástico

Ref	€	Ø (cm)	h (cm)	Pack
61906	9,30	7	12,5	6



### Dispensador miel

Distributeur de miel  
Honigbehälter  
Honey dispenser  
Dosificador mel

Ref	€	Ø (cm)	h (cm)	Pack
61909	11,30	7	12,5	6



### Molinillo plástico

Moulin corps transparent  
Salz-Pfeffertreuer, transparent  
Transparent grinder  
Moinho plástico

Ref	€	Ø (cm)	h (cm)	Pack
61913	10,90	7	12,5	6



## Especieros Inox

Capacidad · Capacity: 300 gr

### Especiero malla fina

Saupoudreuse à maille  
Gewürzdose/Streuer-Fein  
Shaker plastic cover fine mesh lid  
Polvilhador rede fina



Ref	€	Ø (cm)	h (cm)	Pack
62903	7,40	7	9,50	12

### Especiero agujeros queso

Saupoudreuse à figures, fromage  
Gewürzdose/Streuer für Käse  
Shaker plastic cover hole lid for cheese  
Polvilhador para queijo



Ref	€	Ø (cm)	h (cm)	Pack
62904	6,80	7	9,50	12

### Especiero agujeros grandes

Saupoudreuse à figures, grosses  
Gewürzdose/Streuer, Lochung Gross  
Large shaker plastic cover hole lid  
Polvilhador burucos grandes



Ref	€	Ø (cm)	h (cm)	Pack
62905	7,00	7	9,50	12

### Especiero agujeros pequeños

Saupoudreuse à figures, fines  
Gewürzdose/Streuer, Lochung Klein  
Small shaker plastic cover hole lid  
Polvilhador burucos pequeno



Ref	€	Ø (cm)	h (cm)	Pack
62906	7,00	7	9,50	12

### Especiero para hierbas

Saupoudreuse à épices et condiments  
Gewürzdose  
Shaker herb box  
Polvilhador para ervas



Ref	€	Ø (cm)	h (cm)	Pack
62907	6,70	7	9,50	12

Capacidad · Capacity: 80 gr

### Especiero Multiusos

Saupoudreuse multi-usage  
Gewürzdose/ Streuer, multifunktional  
Multipurpose shaker  
Polvilhador multiusos



Ref	€	Ø (cm)	h (cm)	Pack
62409	7,50	4,2	7,50	6



**Cerrado**  
Fermé  
Geschlossen  
Closed  
Fechado



**Espices**  
Épices  
Mehrzweck  
Spices  
Espécies



**Palillos**  
Cure-dents  
Zahnstocher  
Toothpicks  
Palitos



**Pimienta**  
Poivre  
Pfeffer  
Pepper  
Pimienta



**Sal**  
Sel  
Salz  
Salt  
Sal

### Salero-Pimentero WHITE

Salière et Poivrière  
Saltz-Pfeffer  
Salt-Pepper  
Saleiro-Pimenteiro



Ref	€	ml	Pack
62471	19,80	65	10



#### Base magnética. Apertura automática

Appuyez Appuyez Appuyez Appuyez  
Drücken Appuyez Appuyez Appuyez  
Appuyez Appuyez Appuyez Appuyez  
Impresa Impresa Impresa Impresa Impresa

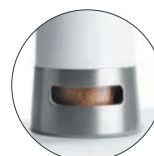

#### Ranura en la parte inferior para controlar el contenido

Appuyez Appuyez Appgfn thn uykmnuimkuiuyez Appuyez  
Drücken Appuy.mjkm.jkm.klm.kl.k.klez Appuyez Appuyez  
Appuyez Appuyez Anm.ljm.,ill.kjm.k.uk.lppuyez Appuyez  
Impresa Impresa ljm.jkm.jkm.jkm.lk.lm.,km.mpresa  
Impresa

Inox  
18/10

## Molinillos

### Molinillo DUAL Pimienta - Sal eléctrico

Moulin à poivre-sel électrique DUAL  
Elektrische Pfeffer-Satzmühlen, DUAL  
DUAL pepper-salt electric grinder  
Moinho pimenta-sal eléctrico DUAL

Ref	€	Ø (cm)	Pack
62824	17,50	7x18	12



**Compartimientos y pulsador independientes**  
Compartiments et bouton/poussoir indépendants  
Fächer und unabhängige Tasten  
Independent compartments and switch  
Compartimentos e botão de pressão independentes

**Fácil de rellenar**  
Facile à remplir  
Leicht zu befüllen  
Easy to fill  
Fácil de encher

### Molinillo de pimienta

Moulin à Poivre  
Pfeffermühle  
Pepper Grinder  
Moinho de pimenta em madeira

Ref	€	h (cm)	Pack
63215	21,30	15	1
63220	24,90	20	1
63225	29,60	25	1

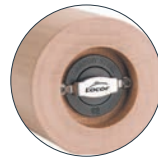

**Mecanismo de acero templado**  
Mécanisme en acier trempé  
Mechanismus aus gehärteten Stahl  
Mechanism in hardened steel  
Mecanismo de aço temperado

### Molinillo de pimienta en policarbonato

Moulin à Poivre en polycarbonate  
Pfeffer/Salzmühle aus Polycarbonat  
Pepper Grinder in polycarbonate  
Moinho de pimenta em policarbonato

Ref	€	h (cm)	Pack
62814	18,30	14	6
62818	18,80	18	6
62823	20,70	23	6



**Mecanismo cerámico**  
Mécanisme ceramique  
Mechanismus aus Keramish  
Mechanism ceramic  
Mecanismo de cerâmica

PC  
Polycarbon

### Molinillo doble

Moulin double  
Salz und Pfeffermühler Doppelt  
Double grinder  
Moinho duplo

Ref	€	Ø (cm)	g	Pack
62816	16,20	6x18	90	24

2 en 1



Mecanismo cerámico  
Mécanisme ceramique  
Mechanismus aus Keramish  
Mechanism ceramic  
Mecanismo de cerâmica



**Antideslizante en la parte superior e inferior**  
Antidérapant sur la partie supérieure et inférieure  
Oben und unten rutschfest  
Non-slip upper and lower part  
Antiderrapante na parte superior e inferior

ASA  
Acrylic

## Fundición: Cocottes



### Fabricadas en aluminio fundido

Garantizan la absorción y distribución uniforme del calor, sin puntos de sobrecalentamiento

La distribución del calor uniforme por toda la pieza hace que los alimentos no pierdan su jugo durante la cocción, conservando así todos sus nutrientes y vitaminas. Las puntas situadas bajo la tapa, hacen que las gotas fruto de la condensación, vuelvan a caer sobre los alimentos formando un flujo circulante y permanente reduciendo la pérdida de sabores y jugos de los alimentos.

Es la pieza perfecta para: arroces, carnes, pescados, legumbres, verduras, guisos, cremas, salsas, sopas, etc.

Revestimiento antiadherente interior y exterior ILAG:ULTIMATE

Diseño atractivo y funcional

Fabriquée en fonte d'aluminium

Garantit l'absorption et la distribution uniforme de la chaleur, sans points de surchauffe

La distribution de la chaleur uniforme sur toute la pièce permet aux aliments de ne pas perdre leur jus pendant la cuisson, conservant ainsi tous leurs nutriments et vitamines. Les pointes situées sous le couvercle permettent aux gouttes issues de la condensation de retomber sur les aliments, formant ainsi un flux permanent de circulation qui réduit la perte des saveurs et des jus des aliments.

C'est la pièce parfaite pour : riz, viandes, poissons, légumes, ragoûts, crèmes, sauces, soupes, etc.

Revêtement antiadhésif intérieur et extérieur ILAG: ULTIMATE

Style attractif et grande fonctionnalité

Made in cast aluminium

It guarantees the absorption and uniform distribution of heat, without overheating points

The uniform distribution of heat throughout the product makes keep its juices during cooking, preserving all its nutrients and vitamins

The points located under the lid cause the condensation drops to fall back onto the food, forming a permanent and circulating flow and reducing the loss of the food's flavours and juices

This is an ideal product for: rice, meats, fish, beans, vegetables, stews, creams, sauces, soups, etc.

Interior and exterior non-stick coating ILAG: ULTIMATE

Attractive design and great functionality

### Cacerola con tapa MINI

Faitout avec couvercle "MINI"

"MINI" Bratentopf mit Deckel

"MINI" round casserole with lid

Caçarola com tampa "MINI"



Ref	€	Ø (cm)	h (cm)	L	Pack
25909	18,20	10	5,0	0,24	12
25914	26,90	14	7,5	0,90	12

### Cacerola con tapa MINI negra

Faitout avec couvercle MINI noir

MINI Bratentopf mit Deckel, grau

"MINI" black round casserole with lid

Caçarola com tampa MINI negra



Ref	€	Ø (cm)	h (cm)	L	Pack
25910	18,20	10	5,0	0,24	12
25915	26,90	14	7,5	0,90	12

### Cacerola oval con tapa MINI

Faitout Ovale avec couvercle "MINI"

"MINI" Oval Bratentopf mit Deckel

"MINI" oval round casserole with lid

Caçarola oval com tampa "MINI"



Ref	€	cm	h (cm)	L	Pack
25911	19,20	12x8,5	5,0	0,25	12

### Cacerola oval con tapa MINI negra

Faitout ovale avec couvercle MINI noir

MINI Oval Bratentopf mit Deckel, grau

"MINI" black oval round casserole with lid

Caçarola oval com tampa MINI negra



Ref	€	cm	h (cm)	L	Pack
25912	18,10	12x8,5	5,0	0,25	12



## Magma



Hierro Fundido  
Cast Iron

**Construida en una sola pieza**  
**Recubierta con una capa de aceite vegetal**  
**Ideal para cocinar, prolonga suavemente la cocción**  
**Gran conductor del calor, mantiene el calor mientras disfrutas y saboreas la comida**  
**Base de madera para servir y presentar la comida recién cocinada**

Construite en une seule pièce  
 Revêtu d'une couche d'huile végétale  
 Idéal pour cuisiner, prolonge délicatement la cuisson  
 Grand conducteur de chaleur, maintient le plat au chaud pendant que vous dégustez la nourriture  
 Base en bois pour servir et présenter le plat fraîchement cuisiné

Aus einem Stück gefertigt  
 Beschichtet mit einer Schicht von Pflanzenöl  
 Ideal zum Kochen, verlängert den Kochvorgang auf sanfte Weise  
 Hervorragender Wärmeleiter; erhält die Wärme während Sie die Speisen genießen  
 Holzbasis, auf der das soeben zubereitete Gericht serviert und präsentiert wird

Built in one piece  
 Coated with a layer of vegetable oil  
 Ideal for cooking; gently continues to cook  
 Great heat conductor; retains heat while you enjoy and savour the food  
 Wooden base to serve and present freshly cooked food

Elementos fabricados a partir de uma única peça  
 Revestidos com uma camada de óleo vegetal  
 Ideal para cozinhar, prolonga suavemente a cocção  
 Excelente condutor do calor, mantém o calor enquanto desfrutas da comida  
 Base de madeira para servir e apresentar a comida recém-preparada



### Cacerola con base

Faitout avec basse  
 Bratentopf mit Holzsockel  
 Casserola with base  
 Caçarola com base

Ref	€	Ø (cm)	ml	Pack	
25871	12,40	12	150	1	
25872	17,00	15,5	300	1	
25873	21,80	18	600	1	<b>New</b>



### Cacerola oval con base

Faitout ovale avec basse  
 Oval Bratentopf mit Holzsockel  
 Oval casserola with base  
 Caçarola oval com base

Ref	€	cm	ml	Pack	
25881	12,50	15x10	200	1	
25882	19,30	17,5x12,5	300	1	
25883	21,60	21,7x15	700	1	<b>New</b>

## New



### Cacerola sin base

Faitout sans basse  
 Bratentopf ohne Holzsockel  
 Casserola without base  
 Caçarola sem base

Ref	€	Ø (cm)	ml	Pack	
25771	8,50	12	150	1	
25772	12,50	15	300	1	
25773	15,10	18	600	1	

## New



### Cacerola oval sin base

Faitout ovale sans basse  
 Oval Bratentopf ohne Holzsockel  
 Oval casserola without base  
 Caçarola oval sem base

Ref	€	cm	ml	Pack	
25781	9,80	15x10	200	1	
25782	15,30	17x12	300	1	
25783	17,40	21,7x15	700	1	

**New**



**Mini Plancha Grill lisa rectangular**

Mini Plaque Grill lisse rectangulaire  
Mini Platte Grill, glatt, rechteckiger  
Mini rectangular Grill plaque flat  
Mini Plancha Grill liso rectangular

Ref	€	cm	h (cm)	Pack
25874	12,20	22,5x10	2,5	1

**New**



**Mini Plancha Grill cuadrado**

Mini Plaque Grill carré  
Mini Platte Grill, Quadrat  
Mini square Grill plaque  
Mini Plancha Grill cuadrado

Ref	€	cm	h (cm)	Pack
25875	12,20	19,5x14	1,7	1

**New**



**Mini Grill**

Mini Grill  
Mini Grill  
Mini Grill  
Mini Grill

Ref	€	cm	h (cm)	Pack
25876	13,90	21x13,5	2,5	1

**New**



**Mini sartén lisa**

Mini poêle lisse  
Mini Pfanne  
Mini frying pan flat  
Mini sertã lisa

Ref	€	cm	h (cm)	Pack
25877	12,90	22x12,5	1,7	1

## Mini cubos · Cestillos



### Fabricados en acero inoxidable

Una forma elegante y original de servir toda clase de aperitivos y tapas  
La presentación puede ser sobre papel absorbente o bien directamente sobre el cestillo

Conception en acier inoxydable

Une façon élégante et originale de servir tout type d'apéritifs et amuse-gueules  
La présentation peut être réalisée sur du papier absorbant ou bien directement sur le panier

Aus widerstandfähigen Edelstahl

Eine elegante und originelle Art und Weise alle Art von Aperitifs und Tapas zu servieren

Die Präsentation kann auf saugfähigem Papier oder direkt im Körbchen erfolgen

Made of stainless steel

An elegant and original way to serve all kinds of snacks and tapas  
Can be presented on absorbent paper or directly on the rack

Fabricadas em aço inoxidável

Uma forma elegante e original de servir todo o tipo de aperitivos e de tapas  
A apresentação pode ser sobre papel absorvente, ou diretamente no cesto

*NO válidos para freír*  
*NOT valid for frying*



**A**



**B**



**C**



### Mini cubo

Mini-cube  
Mini-Würfel  
Mini cube  
Mini cubo

	Ref	€	Ø (cm)	h (cm)	ml	Pack
<b>A</b>	61107	3,80	7	7,0	200	1
<b>B</b>	61109	4,50	9	9,0	340	1
<b>C</b>	61112	6,00	12	12,0	900	1

### Cestillo redondo

Panier rond  
Korb, Rund  
Round basket  
Cesta redonda



### Cestillo redondo BRONCE

Panier rond  
Korb, Rund  
Round basket  
Cesta redonda



Ref	€	Ø (cm)	h (cm)	Pack
61009	7,00	9	8,0	1

Ref	€	Ø (cm)	h (cm)	Pack
61069	7,00	9	8,0	1



**New**



**Cestillo cuadrado**

Panier carré  
Korb, Quadreat  
Square basket  
Cesta quadrada

Ref	€	cm	h (cm)	Pack
61007	7,00	10x8	7,0	1
61052	8,90	12x10	9,0	1



**Cestillo cuadrado BRONCE**

Panier carré  
Korb, Quadreat  
Square basket  
Cesta quadrada

Ref	€	cm	h (cm)	Pack
61067	7,00	10x8	7,0	1
61062	8,90	12x10	9,0	1



**Cestillo cónico**

Panier conique  
Korb, Konisch  
Conical basket  
Cesta cónica

Ref	€	Ø (cm)	h (cm)	Pack
61053	7,70	12	10,0	1



**Cestillo cónico BRONCE**

Panier conique  
Korb, Konisch  
Conical basket  
Cesta cónica

Ref	€	Ø (cm)	h (cm)	Pack
61063	7,70	12	10,0	1



**Cestillo rectangular**

Panier rectangulaire  
Korb, rechteckig  
Rectangular basket  
Cesta rectangular

Ref	€	cm	h (cm)	Pack
61056	10,50	21x11	6,0	1



**Cestillo rectangular BRONCE**

Panier rectangulaire  
Korb, rechteckig  
Rectangular basket  
Cesta rectangular

Ref	€	cm	h (cm)	Pack
61066	10,50	21x11	6,0	1



**Cestillo rectangular con asas**

Panier rectangulaire avec poignées  
Korb, rechteckig mit Griffen  
Rectangular basket with handles  
Cesta rectangular com alças

Ref	€	cm	h (cm)	Pack
61055	10,50	21x11	6,0	1



**Cestillo rectangular con asas BRONCE**

Panier rectangulaire a/poignées  
Korb, rechteckig mit Griffen  
Rectangular basket with handles  
Cesta rectangular com alças

Ref	€	cm	h (cm)	Pack
61065	10,50	21x11	6,0	1



## Mesa

### Sopera con base

Soupiere sur pied  
Suppenschüssel mit Fussreif  
Soup-tureen with base  
Sopeira com base



Ref	€	Ø (cm)	L	Pack
60823	25,60	22	2,00	1
60825	27,40	24	2,50	1
60829	33,80	28	4,00	1

### Tapa sobera

Couvercle soupiere  
Deckel Suppenschüssel  
Soup-tureen lid  
Tampa sopeira



Ref	€	Ø (cm)	Pack
60922	15,80	22	1
60924	17,30	24	1
60928	21,50	28	1

### Legumbreira

Legumiere  
Servierschüssel  
Vegetable dish  
Legumeira



Ref	€	Ø (cm)	Pack
60812	19,90	22	1
60814	22,40	24	1
60818	29,40	28	1

Inox

### 6 bols pequeños

6 petit bols  
6 Schüssel, klein  
Vegetable bowls set of 6  
6 bacias pequenas mesa Service



Ref	€	Ø (cm)	ml	Pack
14012	8,80	12	325	6



### Ensaladera redonda

Saladier ronde  
Salatschüssel, rund  
Round salad bowl  
Bacia de salada redonda



Ref	€	Ø (cm)	L	Pack
62394	9,90	25	4,0	6



### Ensaladera cuadrada

Saladier carée  
Salatschüssel, viereckig  
Square salad bowl  
Bacia de salada quadrada



Ref	€	cm	L	Pack
62395	9,90	27x27x12	4,8	12

### Salsera LUXE con cuchara

Sauciere "Luxe"  
Sauciere Luxe  
Gravy boat "Luxe"  
Molheira "LUXE" com colher



Ref	€	ml	Pack
62424	18,80	200	6

### Salsera ALADINO

Sauciere "Aladino"  
Sauciere "Aladino"  
Gravy boat "Aladino"  
Molheira "Aladino"



Ref	€	ml	Pack
61409	7,80	90	6
61415	9,40	150	6
61424	12,70	240	6
61430	13,60	300	6

### Quesera parmesana con cuchara

Boite à fromage a/cuillere  
Parmesanmenage  
Parmesan bowl with spoon  
Queijeira parmesana com colher



Ref	€	Ø (cm)	ml	Pack
62970	23,30	9x5	200	6

Rec. cristal

62971	3,20			1
-------	------	--	--	---

### Fuente de mantequilla

Beurrer avec couvercle  
Butterdose mit Deckel  
Butter dish with cover  
Manteigueira



Ref	€	cm	h (cm)	Pack
62951	11,30	11,5x22,5	6,5	6



**Azucarero sobremesa**

Sucrier de table sphérique  
Zuckerdose, Küelförmig  
Spherical table sugar bowl  
Açucareiro de mesa esférico



Ref	€	Ø (cm)	ml	Pack
63304	12,30	14	600	27

**Vaso**

Timbale  
Trinkbecher  
Tumbler  
Copo



Ref	€	Ø (cm)	L	Pack
62406	4,70	7,5x10	0,30	20



Inox 18/10

**Cubreplatos**

Cloches  
Tellerabdeckung  
Plate cover  
Cloche para pratos

Ref	€	Ø (cm)	h (cm)	Pack
69024	20,60	24	11,0	6
69029	30,90	28	17,5	6



**Cubre quesos / Tartas**

Couvre Fromage/Gâteau  
Tellerabdeckung  
Cheese/Cake cover  
Cloque para Queijo/Tartes

Ref	€	Ø (cm)	Pack
62380	40,50	32	4

**Números de mesa Inox**

Numéros de table Inox  
Tischnummernschild, Edelstahl  
Table numbers, St Steel  
Números para tabela, Inóx



Ref	€	cm	Números	Pack
61095	16,10	6x5	1-12	6
61096	16,10	6x5	13-24	6
61097	16,00	6x5	25-36	6



**Indicador Reservado**

Indicateur Résevée  
Reserved indikator  
Reserved signal  
Indicador reservado

Ref	€	cm	Pack
61098	3,40	5x12	6

**Soporte menu con pinza Inox 18/10**

Support menu à pince Inox 18/10  
Menükartenhalter, Rostfrei 18/10  
Menu card holder S. Steel 18/10  
Suporte menú com pinça Inóx 18/10

Ref	€	h (cm)	Pack
61005	9,60	12,5	10
61008	10,60	20,0	10
61012	11,90	30,0	10



Inox 18/10

**Pinza sujeta manteles (4 Pcs.)**

Pince à nappe  
Tischtuchklammer  
Tablecloths pegs  
Pinça para toalhas de mesa



Ref	€	Pack
61023	5,50	6

**Campanilla de recepción**

Sonnette de réception  
Rezeptionsklingel  
Reception call bell  
Campainha de receção



Ref	€	Ø (cm)	Pack
61025	9,40	10	12



**Servilletero Bar**

Distributeur de serviettes bar  
Serviettenspender  
Bar napkin holder  
Guardanapo bar

Ref	€	cm	Servilleta	Pack
61001	10,40	8,5x12	90x125	6



**Servilletero Bar**

Distributeur de serviettes bar  
Serviettenspender bar  
Bar napkin holder  
Guardanapo bar

Ref	€	cm	Servilleta	Pack
61002	7,20	9,5x13,5	90x125	4



**Servilletero**

Distributeur de serviettes  
Serviettenspender  
Napkin holder  
Guardanapo

Ref	€	cm	h (cm)	Pack
61004	10,60	18x19	5,0	1



**Papelera sobremesa**

Poubelle de table  
Tish-Abfallbehälter  
Table bin  
Papeleira de mesa

Ref	€	Ø (cm)	L	Pack
63302	18,70	12x16	1,20	6

Inox  
18/10



**Cepillo recoge-migas**

Ramasse-miettes à rouleaux  
Krümelbürste  
Crumbs cleaner  
Escova apanha-migalhas

Ref	€	cm	h (cm)	Pack
64407	11,40	9,5x16,5	4,0	6



**Papelera sobremesa SOFT TOUCH**

Poubelle de table  
Tish-Abfallbehälter  
Table bin  
Papeleira de mesa

Ref	€	Ø (cm)	L	Pack
62358	21,30	12x16	1,20	6



Inox



**Cepillo recogedor HIPERLUXE**

Ramasse-miettes à rouleaux HIPERLUXE  
Krümelbürste, HIPERLUXE  
HIPERLUXE crumbs cleaner  
Escova apanha-migalhas HIPERLUXE

Ref	€	cm	Pack
64408	37,30	14,5x17	1

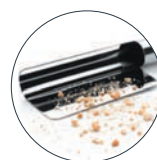

**Cepillo recogedor LUXE**

Ramasse-miettes LUXE  
Krümelbürste, LUXE  
LUXE crumbs cleaner  
Espátula apanha-migalhas LUXE

Ref	€	cm	Pack
64409	24,50	22x7	1



Inox  
18/10

Inox  
18/10



**Bandeja con pinza para notas**

Porte addition à pince  
Platte mit Klemmvorrichtung  
Bill holder  
Bandeja com pinça para notas

	Ref	€	cm	Pack
A	68007	4,20	11x15,2	12
B	68017	5,00	12x21,5	12

**Cenicero cuadrado**

Cendrier carre  
Aschenbecher, viereckig  
Ashtray square  
Cinzeiro quadrado

Ref	€	Ø (cm)	Pack
62941	5,00	14	48



**Cenicero redondo**

Cendrier rond  
Aschenbecher, rund  
Ashtray round  
Cinzeiro redondo

Ref	€	Ø (cm)	Pack
62913	5,80	13	20
62916	7,90	16	20



**Cenicero redondo**

Cendrier rond  
Aschenbecher, rund  
Ashtray round  
Cinzeiro redondo



Ref	€	Ø (cm)	Pack
14013	2,10	14	12
14065	2,40	16	12

## Encendedores

**Encendedor de gas**

Allume-gaz à flamme  
Gasanzünder  
Gas lighter with flame  
Isqueiro de gás

Ref	€	L (cm)	Pack
68987	3,00	27	6



**Encendido con gatillo**

Recargable. Regulador de llama  
Sistema de bloqueo de seguridad



Allumage avec gâchette  
Rechargeable. Régulateur de flamme  
Système de sécurité par blocage

Entzündet auf Knopfdruck  
Wieder aufladbar. Flammenregler  
Sicherheitssperre

Trigger lighter  
Rechargeable. Flame regulator  
Safety lock system

Com gatilho para acender  
Recarregável. Regulador de chama  
Sistema de bloqueio de segurança

**Encendedor de gas caña fija**

Allume-gaz à flamme tige fixe  
Gasanzünder, Stab fixe  
Gas lighter with flame fixe rod  
Isqueiro de gás fixa

	Ref	€	L (cm)	Pack
A	68976	27,70	-	1
B	68978	2,60	27	12



**Encendedor de gas caña flexible**

Allume-gaz à flamme tige flexible  
Gasanzünder, Stab biegsam  
Gas lighter with flame flexible rod  
Isqueiro de gás flexível

	Ref	€	L (cm)	Pack
A	68977	35,80	-	1
B	68979	3,20	27	12





Pinzas  
Tongs

#CocinaConLacor



**Pinza servicio mesa Inox 18% Cr.**

Pince à servir en Inox 18% Cr.  
Servierzange, Edelstahl 18% Cr.  
St. steel 18% Cr. serving tong  
Pinça de serviço de mesa Inóx 18% Cr.



Ref	€	L (cm)	Pack
62307	3,80	21	6

**Tenedor - Cuchara servir**

Pince à service  
Servierzange  
Utility tong  
Garfo e colher de servir



Ref	€	L (cm)	Pack
68009	8,00	24	6



**Cuchara pinza servir**

Cuillère pince à service  
Servierlöffel, Zange  
Serving spoon tong  
Concha pinça de servir



Ref	€	L (cm)	Pack
62353	9,90	24	6

**Pinza hamburguesa**

Pince inox pour hamburger  
Zange für Burgers  
Tongs for beef Burgers  
Pinça de hamburger



Ref	€	L (cm)	Pack
62318	9,70	24	12

**Pinza pasta LUXE**

Pince à spaghetti Luxe  
Teigwaren Zange Luxe  
Pasta Tong Luxe  
Pinça massas Luxe



Ref	€	L (cm)	Pack
62981	8,20	20	12

**Pinza pasta**

Pince à spaghetti  
Teigwaren-Zange  
Spaguetti Tong  
Pinça massas



Ref	€	L (cm)	Pack
62986	4,20	19	12

**Pinza pan**

Pince à pain  
Brotzange  
Bread tong  
Pinça pão



Ref	€	L (cm)	Pack
62978	7,10	18	6

**Pinza pan**

Pince à pain  
Brotzange  
Bread tong  
Pinça pão



Ref	€	L (cm)	Pack
62982	13,70	23	12



**Pinza ensalada plástico**

Pince à salade en plastique  
Salad plastik zange  
Salad plastic tong  
Pinça de salada plástico



Ref	€	L (cm)	Pack
68021	3,80	28,5	12



**Pinza ensalada**

Pinces a salade  
Salatzange  
Salad scissor tong  
Pinça de salada



Ref	€	L (cm)	Pack
62374	7,30	29	24



**Tenedor + Cuchara ensalada**

Fourchette + Cuillère a salade  
Acrylgable + Löffel  
Salad spoon + fork  
Garfo + colher de salada



Ref	€	L (cm)	Pack
62399	6,10	30	24

**Pinza azucarillos**

Pince à sucre  
Zucker-Zange  
Food tong  
Pinça p/cubos de açúcar



Ref	€	L (cm)	Pack
62985	2,80	11	6

**Pinza repostería**

Pince à gateau  
Gebäck-Tortenzange  
Cake tong  
Pinça pastelaria



Ref	€	L (cm)	Pack
62317	9,50	20	12

**Pinza repostería con anillas**

Pince à gateau avec anneaux  
Gebäckzange  
Cake tong with rings  
Pinça pastelaria com anilhas



Ref	€	L (cm)	Pack
68008	4,70	16	6

**Pinza hielo**

Pince à glace  
Eiszange  
Ice tong  
Pinça de gelo



Ref	€	L (cm)	Pack
62306	3,60	18,5	12

**Pinza hielo LUXE Inox 18% Cr.**

Pince à glace Luxe en Inox 18% Cr.  
Eiszange, Luxe, Edelstahl 18% Cr.  
S. steel 18% Cr. Luxe Ice tong  
Pinça de gelo Luxe Inóx 18% Cr.



Ref	€	L (cm)	Pack
62337	7,90	20	12

**Pinza de Hielo**

Pince à glace  
Eiszange  
Ice tong  
Pinça de gelo



Ref	€	L (cm)	Pack
62977	6,50	14	12

**Pinza multiusos LUXE**

Pince multi-usages  
Allzweck Zange  
Multipurpose tong  
Pinça multiusos Luxe



Ref	€	L (cm)	Pack
62334	15,90	25	12

**Pinza multiusos**

Pince multi-usages  
Allzweck-Zange  
Luxe tong  
Pinça multiusos



Ref	€	L (cm)	Pack
62984	2,90	16	5

**Pinza LUXE**

Pince Luxe  
Zange Luxe  
Luxe tong  
Pinça Luxe



Ref	€	L (cm)	Pack
62983	12,30	30	12



**Pinza Jumbo**  
Pince de service  
Jumbo Zange  
Utility tong  
Pinça Jumbo



Ref	€	L (cm)	Pack
62924	4,50	24	1
62930	5,30	30	1
62940	6,30	40	1

**Pinza Jumbo Nylon**  
Pince de service  
Jumbo Zange  
Utility tong  
Pinça Jumbo



Ref	€	L (cm)	Pack
62926	6,00	24	1
62929	6,90	30	1
62939	8,90	40	1

**Pinza de Nylon-Silicona PUSH**  
Pince en Nylon-Silicone  
Grillzange, Nylon-Silikon  
Nylon-Silicone tong  
Pinça de Nylon-Silicone



Ref	€	L (cm)	Pack
62947	12,50	30	6



**Agarre consistente**  
pince fermement  
Konsequente Griff  
Consistent grip  
Aderência consistente



**Apertura y cierre con un dedo**  
Ouverture et fermeture avec un seul doigt  
Öffnen und Schließen mit einem Finger  
Opening and closing with one finger  
Abertura e fecho com um dedo



**Mango revestido, en distintos colores, con una capa de ABS aislante térmico y mejor sujeción**

Manche enrobé, en différentes couleurs, d'une couche d'ABS isolante thermique et une meilleure prise en main  
Griff in verschiedenen Farben mit einer isolierenden und antirutsch ABS-Schicht überzogen  
Handle coated, in different colours, with a layer of ABS thermal insulation and an enhanced grip  
Mango revestido com uma capa de ABS isolante térmico, de diferentes cores, para uma melhor sujeição



**Pinzas KARU**  
Pinces  
Zanges  
Tongs  
Pinças

	Ref	€	L (cm)	Color	Pack
<b>A</b>	63060	5,90	24	R rojo / Red	12
<b>B</b>	63061	5,90	24	Negro / Black	12
<b>C</b>	63062	5,90	24	Azul / Blue	12
<b>D</b>	63063	5,90	24	Amarillo / Yellow	12
<b>E</b>	63064	5,90	24	Verde / Green	12
<b>F</b>	63065	5,90	24	Marrón / Brown	12

Ref	€	L (cm)
63070	6,30	30
63071	6,30	30
63072	6,30	30
63073	6,30	30
63074	6,30	30
63075	6,30	30





**Pinzas silicona (25 pcs.)**

Pinces silicon  
Silikon Zanges  
Silicone tongs  
Pinças silicone

	Ref	€	L (cm)	Color	Pack
<b>A</b>	64434	53,30	-	Caja (25 pcs) / Set (25 pcs)	1
<b>B</b>	64432	2,20	18,0	Naranja / Orange	12
<b>C</b>	64433	2,20	18,0	Rojo / Red	12
<b>D</b>	64436	2,20	18,0	Azul / Blue	12
<b>E</b>	64437	2,20	18,0	Verde / Green	12
<b>F</b>	64439	2,20	18,0	Morada / Purple	12

SI 200°C  
Silicone max.



**Pinza larga silicona**

Pince long en silicone  
Zange aus Silikon  
Long Silicone tong  
Pinça comprida silicone

Ref	€	L (cm)	Pack
62931	7,20	29	12

**Pinza Grill**

Pince à grill  
Grilltange  
Grill tong  
Pinça grelhador



Ref	€	L (cm)	Pack
62933	12,00	30	6

**Pinza emplatat**

Pince de précision condée  
Zange  
tong  
Pinça



Ref	€	L (cm)	Pack
62954	4,20	16,0	24

**Pinza de precisión**

Pince de précision  
Präzision Glatt zange  
Precision tong  
Pinça de precisão



Ref	€	L (cm)	Pack
62821	5,00	21,0	24

**Pinza de precisión recta**

Pince de précision droite  
Präzision Glatt zange  
Straight precision tong  
Pinça de precisão reta



Ref	€	L (cm)	Pack
62955	4,20	15,5	24
62956	8,40	21,0	24

**Tenaza extractor huesos aceitunas**

Dénoyauteur, Chromé  
Olivenentsteiner, Verchromt  
Zinc alloy live seed remover  
Tenaz extrator de ossos de azeitonas



Ref	€	L (cm)	Pack
62973	6,40	16	12



**Tenaza marisco**  
Pince à casse-homard  
Hummerzange  
Lobster cracker  
Tenaz mariscos

Ref	€	L (cm)	Pack
62908	9,60	16	12

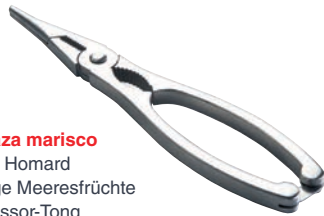

**Tijera - Tenaza marisco**  
Pince Casse Homard  
Schere/Zange Meeresfrüchte  
Sea food Scissor-Tong  
Tesoura-Tenaz marisco

Ref	€	L (cm)	Pack
62974	13,40	18,5	12



**6 pinchos para marisco**  
Ensemble 6 curettes à homard  
Hummergabel (6)  
6 Pcs. seafood forks  
6 espetos para marisco

Ref	€	L (cm)	Pack
62976	23,70	18,5	12



Inox

**Desescamador de pescado**  
Grattoir de poissons  
Fischschuppenentferner  
Fish scaler  
Raspador de peixe

Ref	€	L (cm)	Pack
39040	6,70	19	12



**Desescamador de pescado**  
Grattoir de poissons  
Fischschuppenentferner  
Fish scaler  
Raspador de peixe

Ref	€	L (cm)	Pack
39041	9,40	27,5	12



**Pinza quita-espinas**  
Pince à arêtes  
Grätenzange  
Fish-bone tweezers  
Pinça tira-espinhas

Ref	€	L (cm)	Pack
62938	3,70	8	1
62928	4,70	12	1



**Abre ostras LUXE Inox 18/10**  
Couteau à huîtres LUXE en Inox 18/10  
Austermesser, LUXE, Rostfrei 18/10  
LUXE oyster opener st. steel 18/10  
Aberto-ostras Luxe Inóx 18/10

Ref	€	L (cm)	Pack
62684	10,10	20	1



**Pinza para horno y bandeja GN**  
Pince inox pour bac Gastronorm  
Zange für GN Behälter  
Tong GN tray  
Pinça para forno e bandejas GN

Ref	€	L (cm)	Pack
62989	13,60	20	1



200°C  
max.

**Pinza con silicona para horno y bandeja**  
Pince Inox pour bac Gastronorm avec Silicone  
Zange für GN Behälter, mit Silikon  
Oven tray tong with Silicone  
Pinça para forno e bandejas com silicone

Ref	€	L (cm)	Pack
62998	13,70	20	12



200°C  
max.

**Pinza para platos calientes con silicona**  
Pince pour les plats chauds avec Silicone  
Zange für heiße Platten, mit Silikon  
Tong for hot plates with Silicone  
Pinça para pratos quentes com silicone

Ref	€	L (cm)	Pack
62999	13,70	19	12



**Cascanueces**  
Casse Noix  
Nussknacker  
Nut Cracker  
Parte-nozes

Ref	€	Pack
63017	15,30	6



**Cascanueces ZAMAK**  
Casse noix "ZAMAK"  
Nussknacker, "ZAMAK"  
"ZAMAK" Nut cracker  
Parte-nozes "ZAMAK"

Ref	€	Pack
63016	12,60	6



Cafetería  
Coffee

#CocinaConLacor





## Classic

**Tetera**  
Théière  
Teekanne  
Tea pot  
Bule



Ref	€	L	Pack
62023	15,40	0,23	6
62035	17,10	0,35	6
62060	23,30	0,60	6
62010	28,70	1,00	6

**Cafetera**  
Cafetière  
Kaffeekanne  
Coffee pot  
Cafeteira



Ref	€	L	Pack
62135	18,90	0,35	6
62160	25,40	0,60	6
62110	28,20	1,00	6
62115	39,30	1,50	6
62120	45,20	2,00	6

**Lechera**  
Cremiere  
Milchkanne  
Creamer  
Leiteira



Ref	€	L	Pack
62215	7,30	0,15	6
62225	11,50	0,25	6
62235	12,10	0,35	6
62260	14,20	0,60	6
62210	17,70	1,00	6
62216	27,50	1,50	6
62220	32,80	2,00	6

## Zenit

**Azucarero**  
Sucrier  
Zuckerdose  
Sugar bowl  
Açucareiro



	Ref	€	L	Pack
<b>A</b>	62001	13,00	0,23	6
<b>B</b>	62003	16,10	0,35	6

**Tetera**  
Théière  
Teekanne  
Tea pot  
Bule



Ref	€	L	Pack
58025	49,20	0,25	6
58060	59,80	0,60	6
58090	68,50	0,90	6
58012	77,40	1,20	6

## Luxe

**Tetera**  
Théière  
Teekanne  
Tea pot  
Bule



Ref	€	L	Pack
65025	32,30	0,25	6
65035	34,10	0,35	6
65060	40,30	0,60	6
65012	50,60	1,20	6

**Cafetera**  
Cafetière  
Kaffeekanne  
Coffee pot  
Cafeteira



Ref	€	L	Pack
65135	33,60	0,35	6
65160	40,20	0,60	6
65110	51,00	1,00	6
65118	60,30	1,80	6

**Lechera**  
Cremiere  
Milchkanne  
Creamer  
Leiteira



Ref	€	L	Pack
65215	12,20	0,15	6
65235	20,90	0,35	6
65260	25,20	0,60	6
65210	36,10	1,00	6
65218	46,90	1,80	6

**Azucarero**  
Sucrier  
Zuckerdose  
Sugar bowl  
Açucareiro



Ref	€	L	Pack
65003	27,90	0,35	6
65004	32,40	0,60	6



## Cafeteras



Fabricadas en acero inoxidable 18/10 de gran calidad y resistencia  
Diseño elegante

Asa formada por un solo tubo de acero aislante del calor

Válvula de seguridad oculta dentro del sistema de cierre

Alta conductividad térmica. Café aromático y sabroso en cuestión de minutos  
Aptas para todo tipo de fuegos, incluida la inducción. Apta para el lavavajillas

Fabriquéés en acier inoxydable 18/10 d'une grande qualité et résistance  
Conception élégante

Anse composée d'un seul tube en acier isolant de la chaleur

Soupape de sécurité cachée dans le système de fermeture

Haute conductivité thermique. Café aromatique et savoureux en quelques minutes

Compatibles avec tous types de feux, y compris l'induction. Apte pour le lave-vaisselle

Aus widerstandsfähigem und hochwertigem Edelstahl 18/10

Edles Design

Griff aus wärmeisolierendem Stahlrohr

Sicherheitsventil im Verschluss versteckt

Hohe Wärmeleitfähigkeit. Minutenschneller aromatischer Kaffeeegenuss

Für alle Herdarten inklusive Induktion geeignet. Spülmaschinengeeignet

Made from high quality, durable 18/10 stainless steel

Stylish design

Handle formed from a single heat-resistant steel tube

Safety valve hidden within the closure system

High thermal conductivity. Aromatic, flavourful coffee in a matter of minutes

Suitable for all types of hob, including induction hobs. Dishwasher safe

Fabricadas em aço inoxidável 18/10 de grande qualidade e resistência

Design elegante

Asa formada por um único tubo de aço, que isola do calor

Válvula de segurança oculta dentro do sistema de fecho

Alta condutividade térmica. Café aromático e saboroso em poucos minutos

Aptas para todo o tipo de fogões, incluindo as placas de indução. Apta para máquinas de lavar louça



Válvula oculta  
Hidden valve

Acabado Mate  
Satin finish



### Cafetera Express MOKA

Cafetière Express MOKA  
Kaffeekanne, MOKA  
MOKA Express coffee pot  
Cafeteira expresso MOKA

Ref	€	Tazas	Pack
62054	44,90	4	6
62056	51,40	6	6
62051	61,00	10	6



### Cafetera Express HYPERLUXE

Cafetière Express HYPERLUXE  
Kaffeekanne, HYPERLUXE  
HYPERLUXE Express Coffee  
Cafeteira café expresso HYPERLUXE

Ref	€	Tazas	Pack
62202	60,20	2	6
62204	68,40	4	6
62211	90,40	10	6

Hasta fin de existencias · While stocks last

### Cafetera cristal Inox 18% Cr.

Cafetière en verre en Inox 18% Cr.  
Glaskaffeekanne, Edelstahl 18% Cr.  
Coffee pot w/glass st. steel 18% Cr.  
Cafeteira vidro Inóx 18% Cr.l

Ref	€	Tazas	L	Pack
62153	23,10	2	0,35	6
62180	33,50	6	0,80	6



### Batidor Capuccino

Batteur pour Cappuccino  
Capuccino- Mixer  
Capuccino mixer  
Batedor capuccino

Ref	€	W	Pack
69041	20,70	2,7	1



## Cafeteras pavas



**Cafetera Pava**  
Cafetière pava  
Kaffeekanne Pava  
Coffee pot  
Chaleira

Ref	€	L	Pack
68215	28,70	1,00	1
68225	34,60	2,00	1
68235	42,30	2,80	1
68205	48,60	4,00	1

**Fabricada en acero inoxidable 18/10 de gran calidad y resistencia**  
**Cafetera con fondo Sandwich (Inox 18/10 - Aluminio - Inox)**  
**Garantiza la absorción y distribución uniforme del calor**  
**Agua y café molido infusionan consiguiendo un café de gran sabor y aroma**  
**Asa abatible y pomo de baquelita**  
**Apta para todo tipo de cocinas, incluida la inducción**

Fabriqué en acier inoxydable 18/10 d'une grande qualité et résistance  
Cafetière avec fond Sandwich (Inox 18/10 - Aluminium - Inox)  
Garantit l'absorption et la distribution uniforme de la chaleur  
Eau et café moulu s'infusent, obtenant ainsi un café d'une grande saveur et d'un profond arôme  
Anse rabattable et poignée en bakélite.  
Apte pour tout type de cuisinières, y compris à induction

Aus widerstandsfähigem und hochwertigem Edelstahl 18/10  
Kaffeekanne mit wärmeleitendem Sandwichboden (Edelstahl 18/10 - Aluminium - Edelstahl)  
Garantiert gleichmäßige Wärmeaufnahme und -verteilung  
Verwandelt Wasser und gemahlene Bohnen in hocharomatischen Kaffee mit hervorragendem Geschmack  
Umlappbarer Henkel und Deckelgriff aus Bakelit  
Geeignet für alle Herdarten (inkl. Induktion)

Made of high-quality, high-tensile 18/10 stainless steel  
Coffee pot with sandwiched base (18/10 Stainless Steel - Aluminium - St. Steel)  
Ensures even heat absorption and distribution  
Water and ground coffee infuse to make a coffee with great taste and aroma  
Folding handle and Bakelite knob  
Suitable for all types of hobs, including induction

Fabricada em aço inoxidável 18/10 de grande qualidade e resistência  
Cafeteira com fundo Sandwich (Inox 18/10 - Alumínio - Inox)  
Garante a absorção e a distribuição uniforme do calor  
Para preparar infusões de água e café moído, conseguindo um café de grande sabor e aroma  
Asa abatível e pega de baquelite  
Apta para todo o tipo de fogões, incluindo as placas de indução

## Hervidores silbantes



**Hervidor silbante**  
Bouillire sifflante  
Flötenwasserkessel  
Whistling kettle  
Chaleira com apito

Ref	€	L	Pack
68619	29,80	2,00	1
68627	31,50	2,50	1
68629	33,80	3,00	1
68639	34,50	4,00	1

**Alto nivel de calidad y resistencia**  
**Apto para hervir agua o calentar café preparado**  
**Emite un ligero silvido cuando el agua hierve**

Haut niveau de qualité et de résistance  
Apte pour faire bouillir de l'eau et réchauffer du café préparé  
Émet un léger sifflement lorsque l'eau bout

Hochwertig und stabil  
Zum Kochen von Wasser oder Erwärmen von Kaffee geeignet  
Wenn das Wasser kocht, ertönt ein akustisches Signal

High level of quality and resistance  
Suitable for boiling water or heating prepared coffee  
Emits a gentle whistle when the water comes to the boil

Alto nível de qualidade e resistência  
Apto para ferver água ou para aquecer café preparado  
Emite um ligeiro silvo quando a água ferve

**Hervidor silbante**  
Bouillire sifflante  
Flötenwasserkessel  
Whistling kettle  
Chaleira con apito

Ref	€	Color	L	Pack
68643	36,80	Blanco / White	2,50	12
68644	36,80	Negro / Black	2,50	12



# Teteras

**New**



Teteras fabricadas artesanalmente en hierro fundido de alta calidad muy resistentes  
 Incluye infusor extraíble de acero inoxidable  
 Interior esmaltado para evitar la oxidación  
 Aptas para fuegos de gas, inducción, vitrocerámica y eléctrico  
 Se recomienda hacer uso de un hervidor para calentar el agua y evitar así que pierda el color

Théière fabriquée artisanalement en fonte d'aluminium de grande qualité, très résistante  
 Inclut un infuseur extractible en acier inoxydable  
 Intérieur émaillé pour éviter l'oxydation  
 Compatible avec les feux des cuisinières à gaz, à induction, en vitrocéramique et électriques  
 Il est recommandé d'utiliser une bouilloire pour faire chauffer l'eau et ainsi éviter que la théière ne perde sa couleur

Von Hand gefertigte Teekanne aus hochwertigem Gusseisen, sehr robust  
 Einschließlich Teefilter aus rostfreiem Stahl  
 Innen emailliert, um Rostbildung zu vermeiden  
 Geeignet für Gas, Induktions-, Glaskeramik- und Elektroherde geeignet  
 Es wird empfohlen, zum Erhitzen des Wassers einen Wasserkocher zu verwenden, damit keine Verfärbungen an der Teekanne auftreten

This is a high quality, very resistant hand-made, cast iron tea pot  
 Includes a removable, stainless steel infuser  
 Interior is enameled to avoid rusting  
 It can be used on gas, induction, vitroceramic and electric burners  
 It's recommended using a boiler to heat the water and thus keep it from losing its colour

Chaleira fabricada artesanalmente em ferro fundido de alta qualidade e muito resistente  
 Inclui infusor extraível em aço inoxidável  
 Interior esmaltado para evitar a oxidação  
 Apta para gás, indução, vitrocerâmica e elétricos  
 Se recomenda utilizar um fervedor para aquecer a água e assim evitar perdas de cor



Red



White



Bamboo



Black



Green



Brown



Blue



**Tetera**

Théière  
 Teekanne  
 Tea pot  
 Bule

Ref	€	L	Color	Pack	
68663	24,50	0,25	Red	1	<b>New</b>
68667	32,70	0,50	White	1	<b>New</b>
68666	27,40	0,60	Bamboo	1	
68664	39,90	0,70	Black	1	<b>New</b>
68662	36,60	0,80	Green	1	<b>New</b>
68668	30,00	0,80	Brown	1	
68661	33,90	1,10	Blue	1	



The image features three stainless steel thermoses and a teapot arranged on a textured, light-colored placemat. The thermoses are sleek and modern, with a curved body and a decorative handle. The teapot is also stainless steel with a lid. In the foreground, there are two white ceramic cups on saucers. The background is softly blurred, showing green foliage. A semi-transparent white box is centered over the middle thermos, containing text.

Termos  
Thermos

#CocinaConLacor



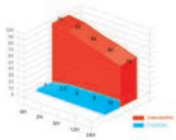

**Air pot**

Air pot  
Getränkenspender, isoliert  
Air pot  
SAir pot

Ref	€	L	h (cm)	Pack
62472	54,00	2,50	32,5	1
62473	59,60	3,00	34,5	1
62475	80,00	3,50	39,0	1



Mantiene las bebidas calientes o frías durante 24 horas

Ligero e irrompible  
Boca ancha para cubos de hielo  
NO utilizar con bebidas gaseosas ni lácteos

Maintient les boissons chaudes ou froides pendant 24 heures  
Léger et incassable  
Bec large pour glaçons  
NE PAS utiliser avec des boissons gazeuses ni des produits laitiers

Hält die Getränke 24 Stunden warm oder kalt  
Leicht und unzerbrechlich  
Breite Öffnung für Eiswürfel  
NICHT mit Getränken mit Kohlensäure oder Milchprodukten verwenden

Keeps drinks hot or cold for 24 hours  
Light and shatterproof  
Wide mouth for ice cubes  
Do NOT use with fizzy drinks or dairy

Mantém as bebidas quentes e frias durante 24 horas  
Leve e inquebrável  
Abertura larga para cubos de gelo  
NÃO utilizar com bebidas gasosas nem lácteos

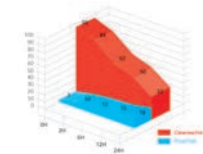

**Jarra Termo Polipropileno**

Pichet thermo en polypropylene  
Thermoskanne aus Polypropylen  
Polypropylene termo jug  
Jarra termo polipropileno

Ref	€	L	Pack
62496	20,90	0,60	1
62491	30,30	1,20	1
62492	38,40	2,00	1



Tapa aislante con pulsador de apertura  
Irrompible, libre de malos olores e inoxidable  
Triple pared aislante para mantener las bebidas frías o calientes  
Fabricado en resina especial para soportar los golpes

Couvercle isolant avec bouton/poussoir d'ouverture  
Incassable, sans mauvaises odeurs et inoxydable  
Triple paroi isolante pour maintenir les boissons froides ou chaudes  
Fabriqué en résine spéciale pour supporter les coups

Dämmender Deckel mit Taste zum Öffnen  
Unzerbrechlich, geruchsneutral und nicht rostend  
Dreifach-Dämmwand, um die Getränke kalt oder warm zu halten  
Aus speziellem, stoßfestem Kunststoff hergestellt

Insulating lid with button for opening  
Shatterproof, free of bad smells and rust-proof  
Triple insulating wall to keep drinks cold or hot  
Manufactured in special resin to resist bangs

Tampa isolante com botão de abertura  
Inquebrável, de aço inoxidável e sem maus odores  
Tripla parede isolante, para manter as bebidas frias ou quentes  
Fabricado em resina especial para suportar os golpes

PP  
Polypropileno

**Servidor termo**

Verseuse isothermo  
Thermoskanne, idoliert  
Vacuum flask  
Servudir termo



Ref	€	Color	L	Pack
62483	25,20	Blanco / White	1,00	6
62484	25,20	Negro / Black	1,00	6

Cuerpo doble pared fabricado en acero inoxidable  
Tapa aislante con pulsador

Corps à double paroi fabriqué en acier inoxydable  
Couvercle isolant avec bouton/poussoir

Doppelwandiges Gehäuse aus rostfreiem Stahl  
Dämmender Deckel mit Taste

Double-walled body manufactured in stainless steel  
Insulating lid with button

Corpo de parede dupla, fabricado em aço inoxidável  
Tampa isolante, com botão de pressão

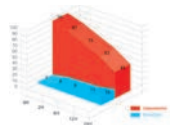

**Jarra Termo LUXE**

Bouteille thermo  
Thermoskanne  
Insulated server  
Jarra termo Luxe

Ref	€	L	Pack
63360	56,10	0,60	1
63310	61,00	1,00	1
63315	70,40	1,50	1
63320	75,10	2,00	1

Termo Hermético

Hermetic Cap



**Jarra Termo**

Bouteille thermo  
Thermoskanne  
Insulated server  
Jarra termo

Ref	€	L	Pack
62430	46,70	0,30	1
62460	51,60	0,60	1
62410	57,10	1,00	1
62415	73,60	1,50	1





**Servidor Termo**

Verseuse thermo  
Thermoskanne, isoliert  
Vacuum flask  
Servidor termo

Ref	€	L	h (mm)	Pack
62481	24,10	1,00	160	1
62482	25,70	1,20	165	1
62485	28,60	1,50	200	1
62486	29,40	2,00	220	1

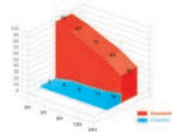

**Termo para líquidos**

Thermo pour liquides  
Thermobehälter für Flüssigkeiten  
Thermo for liquids  
Termo para líquidos



Ref	€	L	h (cm)	Pack
62441	9,90	0,35	20,0	6
62442	11,20	0,50	24,8	6
62443	15,20	0,75	29,8	6
62444	16,40	1,00	33,7	6



**Termo para alimentos sólidos**

Thermo pour aliments solides  
Thermobehälter für feste Speisen  
Thermo for solid food  
Termo para alimentos sólidos

	Ref	€	L	h (cm)	Pack
<b>A</b>	62448	16,90	0,70	19,7	6
<b>B</b>	62440	20,30	1,00	23,5	6
<b>C</b>	62447	23,80	1,50	32,3	6



**Termo para alimentos SOFT TOUCH**

Thermo pour aliments  
Thermobehälter für Speisen  
Thermo for food  
Termo para alimentos

Ref	€	h (cm)	L	Pack
62480	41,40	18	1,40	12



**Termo SOFT TOUCH WHITE**

Thermo Soft Touch  
Thermobehälter Soft Touch  
Thermo Soft Touch  
Termo Soft Touch

Ref	€	h (cm)	L	Pack
62576	10,40	19	0,35	6
62577	11,60	24	0,50	6
62578	14,40	28	0,75	6



**Mantiene las bebidas calientes o frías durante 24 horas**  
**Doble pared y cámara de vacío**  
**Alto rendimiento térmico**

Maintient les boissons chaudes ou froides pendant 24 heures  
Haut rendement thermique  
Double paroi et chambre à vide

Hält die Getränke 24 Stunden warm oder kalt  
Thermisch leistungsstark  
Doppelwände und Vakuumkammer

Keeps drinks hot or cold for 24 hours  
High thermal efficiency  
Double wall and vacuum chamber

Mantém as bebidas quentes e frias durante 24 horas  
Alto desempenho térmico  
Parede dupla e câmara de vácuo



**Termo SOFT TOUCH BLACK**

Thermo Soft Touch  
Thermobehälter Soft Touch  
Thermo Soft Touch  
Termo Soft Touch

Ref	€	Ø (cm)	L	Pack
62476	11,10	8x22	0,35	6
62477	12,50	8x27	0,50	6



Bar-Bodega  
Bar - Wine Cellar  
#CocinaConLacor





## Enfriabotellas

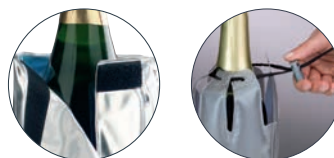

**Enfría en pocos minutos y dura horas**  
**Se adapta a la mayoría de las botellas (0,7 - 1,0 L)**  
**Antes de utilizarlo, meter en el congelador por espacio de 5 horas**  
**El gel refrigerante NO ES TÓXICO**

Refrigidit en quelques minutes et pendant des heures  
 S'adapte à la plupart des bouteilles (0,7 - 1,0 L)  
 Avant son utilisation, mettre au congélateur pendant 5 heures  
 Le gel réfrigérant N'EST PAS TOXIQUE

Kühlt in wenigen Minuten und hält Stunden an  
 Für die meisten Flaschen geeignet (0,7-1,0 l)  
 5 Stunden vor Verwendung in den Gefrierschrank stellen  
 Das Kühlgel ist UNGIFTIG

Cools in a few minutes and lasts hours  
 Adapts to the majority of bottles (0.7 - 1.0 L)  
 Before using it, place in the freezer for 5 hours  
 The refrigerating gel IS NOT TOXIC

Arrefece em poucos minutos, e conserva o frio durante horas  
 Adapta-se à maioria das garrafas (0,7-1,0 l)  
 Antes de o utilizar, introduzi-lo no congelador durante 5 horas  
 Gel refrigerante NÃO TÓXICO

### Enfriador de botellas

Rafraîchisseur à bouteilles  
 Flaschenkühler  
 Bottle cooler  
 Arrefecedor de garrafas

Ref	€	Pack
62325	8,50	6



### Funda enfría-botellas con cordón

Housse refroidissement d'bouteilles a/cordon  
 Flaschenkühler, mit Schnur  
 Bottle cooler cover with cord  
 Arrefecedor de garrafas com cordão

Ref	€	Pack
62355	8,90	6



### Compatible con:

Compatible with:

62315  
 62320  
 62322  
 62321  
 61321  
 61319  
 14121  
 62365  
 62361  
 62362



### Pie Porta-cubos

Porte-seau à champagne  
 Sektkühlerständer  
 Wine cooler stand  
 Pé porta baldes

Ref	€	Ø (cm)	h (cm)	Pack
62300	71,00	20	65	1

### Pie Porta-cubos oval Inox

Porte-oval seau à champagne en inox  
 Sektkühlerständer, oval, Rostfrei  
 St. steel oval wine cooler stand  
 Pé porta baldes oval Inóx

Ref	€	cm	h (cm)	Pack
62342	98,50	30x20	64	1

### Soporte de mesa enfriabotellas

Support seau à champagne  
 Tischhalterung Flaschenkuehler  
 Wine cooler table support  
 Suporte balde de gelo arrefecedor

Ref	€	Ø (cm)	Pack
62478	10,20	18	12
62479	10,20	20	12

### Cubo enfriachampán oval Inox

Seau à champagne oval inox  
 Champagnerkühler, oval  
 St steel oval champaing cooler  
 Balde arrefecedor oval Inóx



Ref	€	cm	L	Pack
62338	65,70	30x20x20	7,00	1

### Enfriabotellas doble pared

Seau à champagne isotherme  
 Champagnerkühler, isoliert  
 Double champaing cooler  
 Arrefecedora de garrafas parede dupla



Ref	€	Ø (cm)	Ø Int. (cm)	Pack
62356	13,20	12,5x20	9,50	6



**Cubo de hielo-champán LUXE asa Inox**

Seau à glace-champagne "Luxe anse inox"  
Sektkübler Luxe  
Wine cooler "Luxe" inox. handle  
Balde arrefecedor Luxe asa Inóx



Ref	€	Ø (cm)	L	Pack
62315	25,10	14	1,20	1
62320	33,60	20	4,50	1
62322	40,70	22	5,50	1

**Cubo enfriabotellas Inox 18/10**

Seau à vin en Inox 18/10  
Champagnerkübler, Rostfrei 18/10  
S. Steel 18/10 wine bucket  
Balde enfria-garrafas Inóx 18/10



Ref	€	Ø Sup.(cm)	Ø (cm)	L	Pack
62321	49,30	21	18	5,50	1

**Cubo cónico asas soldadas**

Seau à glace en inox  
Sektkübler, Rostfrei  
Stainless steel wine cooler w/welded handles  
Balde cónico Asas soldadas



Ref	€	Ø (cm)	L	Pack
61321	19,30	20	4,25	6

**Cubo cónico asas incorporadas**

Seau à glace en inox  
Sektkübler, Rostfrei  
St. steel wine cooler w/fix handles  
Balde cónico Asas incorporadas



Ref	€	Ø (cm)	L	Pack
61319	20,90	20	4,75	6



**Cubo de hielo**

Seau à champagne  
Sektkübler  
Wine cooler  
Balde de gelo



Ref	€	Ø (cm)	L	Pack
14121	15,40	20	4,00	6



**Cubo enfriabotellas negro acrílico**

Seau à vin noir acrilique  
Acryl Champagnerkübler  
Acrylic black wine bucket  
Blade arrefecedora de garrafas negro acrílico

	Ref	€	L	Pack
<b>A</b>	62354	26,80	4,00	6
	62367	26,80	3,00	6
<b>B</b>	62368	38,70	7,00	6



**Cubo enfriabotellas acrílico flor**

Seau à vin acrylique fleur  
Champagnerkübler, Acryl, Blume  
Flower acrylic wine bucket  
Blade arrefecedora de garrafas Acrílico flor



Ref	€	cm	L	Pack
62364	14,00	22x18x23	3,00	1

**Cubo enfriabotellas doble con asas**

Seau Isotherme double avec anse  
Acryl Champagnerkübler  
Acrylic winw cooler with handle  
Blade arrefecedora de garrafas acrílico



Ref	€	L	Pack
62365	25,90	4,50	6



**Cubo enfriabotellas doble**

Seau Isotherme double  
Acryl Champagnerkübler  
Acrylic winw cooler  
Blade arrefecedora de garrafas dupla



Ref	€	L	Pack
62366	31,50	5,50	6



**Cubo enfriabotellas**

Seau à vin  
Champagnerkühle  
Vine bucket  
Bande arrefecedora de garrafas

	Ref	€	Ø (cm)	L	Pack
<b>A</b>	62361	5,00	Ø18x15	1,50	1
<b>B</b>	62362	9,50	Ø22x21	3,50	1
<b>C</b>	62371	21,80	Ø33x25	10,00	1



**Enfriabotellas**

Seau à champagne  
Champagnerkühler  
Champagne cooler  
Arrefecedora de garrafas

Ref	€	cm	L	Pack
62373	23,80	47x29x23	13,00	1



**Barreño liso**

Bassine lisse®  
Glattwanne  
Mirror finish oval cooler  
Bacia lisa

Ref	€	cm	L	Pack
62271	43,90	43x30x20	20,00	1
62272	52,90	53x38x25	27,00	1
62273	61,80	61x43x28	32,00	1



**Champanero Dorado**

Refräichisseur à champagne  
Champagnerkühler  
Champagne cooler  
Champanheiro Dourado

Ref	€	Ø (cm)	L	Pack
62336	102,50	36	11,50	1



**Enfriachampan**

Refräichisseur à champagne  
Champagnerkühler  
Champagne cooler  
Champanheiro

Ref	€	Ø (cm)	L	Pack
62346	67,30	Ø36x20	13,00	1
62347	74,60	Ø40x20	16,00	1



**Champanero LUXE**

Refräichisseur à champagne LUXE  
Champagnerkühler LUXE  
LUXE champagne cooler  
Champanheiro LUXE

Ref	€	Ø (cm)	L	Pack
62436	93,40	36	11,50	1
62439	102,50	40	15,00	1



## Jarras



### Jarra con tapa

Pot avec couvercle  
AcrylKrug mit Deckel  
Pitcher with lid  
Jarra com Tampa



Ref	€	L	Pack
62391	28,20	2,80	6

### Jarra bombada con retén

Pot à eau bombée avec retenu  
Kanne mit Schnaupe  
Rounded water jug with ice guard  
Jarra bojuda com retentor



Ref	€	L	Pack
62702	38,50	2,00	1



### Jarra de agua

Pot à verser  
AcrylKrug  
Water pitcher  
Jarra



Ref	€	L	Pack
62392	10,90	2,00	12
62393	13,80	3,00	12

### Jarra

Pot à eau  
Wasserkanne  
Water jug  
Jarra



Ref	€	Ø (cm)	L	Pack
62716	20,40	12x16	1,50	8
62721	22,50	12x23	2,00	8
62726	25,90	12x26,5	2,50	8



### Botella sifón CO2

Bouteille siphon  
Flasche trap  
Soda maker bottle  
Garrafa armadilha

Ref	€	Ø (cm)	L	Pack
68601	45,00	10x39	1,00	1



### Cargas para botellas sifón CO2

Cartuches CO2 pour siphon  
CO2 Flasche trap  
CO2 soda charges  
Botijas de sifão CO2



Ref	€	Botellas	g	Pack
68602	6,50	10	8	1
68603	15,40	24	8	1

### Jarra con retén

Pot à eau avec retenu  
Wasserkanne mit Schnaupe  
Water jug with ice guard  
Jarra com retentor



Ref	€	Ø (cm)	L	Pack
62715	23,60	12x16	1,50	8
62720	24,60	12x23	2,00	8
62725	27,90	12x26,5	2,50	8



Øvarilla · Rod = 6 mm

### Soporte de copas

Support à coupes  
Ständer Eiskelch  
Cups stand  
Suporte de tapas

	Ref	€	cm	h (cm)	Pack
A	62261	12,30	34x10	6	6
B	62262	17,90	34x20	6	6
C	62263	27,60	34x40	6	4

## Cóctel

### Coctelera tapón Inox

Shaker avec bouchon inox  
Cocktailshaker, mit Edelstahl Verschluss  
Cocktail shaker st. steel lid  
Shaker tampa Inóx

Ref	€	L	Pack
62308I	32,80	0,30	1
62303I	40,90	0,50	1
62304I	48,50	0,75	1



### Coctelera negra

Shaker noir  
Cocktailshaker  
Black cocktail shaker  
Shaker negra

Ref	€	Ø (cm)	L	Pack
62369	16,60	9x20	0,50	1



### Coctelera acrílica con tapón Inox

Shaker acrylique avec bouchon Inox  
Cocktailshaker, Acryl, mit Verschluss  
Acrylic cocktail shaker with st steel cap  
Shaker acrílica com tampa en Inóx

Ref	€	Ø (cm)	L	Pack
62388	16,30	9x22,5	0,45	1



### Cubitera doble pared acrílica con pinza + Tapa

Seau à glace isotherme acrylique a/pince + Couvercle  
Sekt Kühler, Isoliert, Acryl m/Eiszange + Deckel  
Acrylic double wall ice bucket with tong + Lid  
Porta-cubos gelo parede dupla acrílico compinça + Tampa

Ref	€	Ø (cm)	L	Pack
62363	20,20	20x21	3,00	1



### Picadora de hielo manual

Broyeur à glace manuel  
Manuel Eis-Crusher  
Manual ice crusher  
Picadora de gelo manual

Ref	€	cm	Pack
60327	38,90	16x23x12	6

### Librador Policarbonato

Pelle à farine polycarbonate  
Mehlschaufel polycarbonat  
PC ice shovel  
Corredor policarbonato



	Ref	€	ml	Pack
A	67021	4,60	170	6
B	67022	9,40	900	6
C	67023	12,90	1800	6

### Librador Inox 18/10

Pelle à farine Inox 18/10  
Mehlschaufel polycarbonat, Rostfrei 18/10  
St. steel 18/10 ice shovel  
Corredor Inóx



Ref	€	ml	L (cm)	Pack
67012	14,00	60	19,0	1
67013	16,30	110	21,5	1
67014	19,20	200	24,0	1
67016	21,50	260	25,5	1
67017	23,40	360	29,0	1
67018	25,60	470	31,0	1
67019	31,90	640	35,0	1
67020	38,50	860	38,0	1

### Pinza hielo

Pince à glace  
Eiszange  
Ice tong  
Pinça de gelo

Ref	€	L (cm)	Pack
62306	3,60	18,5	12



### Pinza hielo LUXE Inox 18% Cr.

Pince à glace Luxe en Inox 18% Cr.  
Eiszange, Luxe, Edelstahl 18% Cr.  
S. steel 18% Cr. Luxe Ice tong  
Pinça de gelo Luxe Inóx 18% Cr.

Ref	€	L (cm)	Pack
62337	7,90	20	12



### Pinza de Hielo

Pince à glace  
Eiszange  
Ice tong  
Pinça de gelo

Ref	€	L (cm)	Pack
62977	6,50	14	12





**Maza negra mojito**

Pilon noir mojito  
Mojitostößel  
Black mace mojito  
Maço preto mojito

Ref	€	L (cm)	Pack
62278	9,20	18	6
62279	10,30	26	6



**Colador gusanillo**

Passoire à cocktail  
Cocktailsieb  
Cocktail strainer  
Coador batidos

Ref	€	Pack
62326	20,00	1



**Servidor revolver para 4 botellas**

Serviteur pivotant pour boissons 4 cl  
Getränke-Servierer, "Revolver", mit Fuss, 4 cl  
Drinks revolver server w/stand 4 cl  
Servidor revólver para 4 garrafas

Ref	€	L	Pack
62341	79,00	4 cl	1



**New**



**Botella dosificadora cóctel**

Bouteille doseuse à cocktail  
Dosierflasche für Cocktails  
Cocktail pourer  
Garrafa doseadora pour cocktails

Ref	€	Ø (cm)	L	Pack
61932	10,90	9	2,00	1
61939	9,90	9	0,946	1
61935	9,50	9	0,50	1

**New**

**Dosificador licor DUAL**

Mesure à cocktail  
Cocktailmass  
Jigger  
Dosificador licor

Ref	€	h (cm)	cl	Pack
62329	18,60	9,7	2-2,5 / 4-5	1



**Dosificador licor**

Mesure à cocktail  
Cocktailmass  
Jigger  
Dosificador licor

Ref	€	L	Pack
62330	17,10	2/4 cl.	20



**Ideal para bar, en especial para coctelería**

Permite almacenar y servir cómodamente bebidas, jugos y pulpas de frutas para cócteles  
**Botella desmontable en 4 piezas (contenedor, tapa, cuello de botella y boquilla)**  
Contiene 6 boquillas de colores para identificar fácilmente las bebidas  
**Botella resistente y de alta calidad. Fácil de limpiar**

Idéal pour le bar, en particulier pour les bars à cocktails  
Il permet de stocker et de servir facilement des boissons, jus et jus à pulpes de fruits pour cocktails

Bouteille démontable en 4 pièces (réceptacle, couvercle, goulot et embout)  
Elle contient 6 embouts de couleur afin d'identifier facilement les boissons  
Bouteille résistante et de haute qualité. Facile à nettoyer

Idéal für Cocktailbar und Kneipe  
Zum Aufbewahren und Ausgießen von Getränken, Fruchtsäften und Cocktailsirup  
4-teilige Flasche (Behälter, Deckel, Flaschenhals und Ausgießer)  
Mit 6 farbigen Ausgießern zur Kennzeichnung des Inhalts  
Aus robustem und hochwertigem Material. Leichte Reinigung

Perfect for the bar and especially making cocktails  
You can use it for conveniently storing and serving drinks, juices and fruit pulp for cocktails  
The bottle can be taken apart into 4 pieces (container, lid, neck and mouth)  
Includes 6 coloured mouths to easily identify drinks  
High quality and sturdy bottle. Easy to clean

Idéal para o bar, em especial para preparar cocktails  
Permite armazenar e servir comodamente bebidas, sumos e polpa de frutas para cocktails  
Garrafa desmontável em 4 peças (recipiente, tampa, gargalo da garrafa e boquilha)  
Contém 6 boquilhas de cores para identificar facilmente as bebidas  
Garrafa resistente e de alta qualidade. Fácil de limpar

**Cucharilla cocktail**

Cuillère cocktail  
Barlöffel  
Cocktail spoon  
Colher cocktail

Ref	€	L (cm)	Pack
62302	3,60	27	12



**Cucharilla cocktail rizada**

Cuillère cocktail cannelée  
Barlöffel, gewellter  
Cocktail long spoon  
Colher cocktail frizada

Ref	€	L (cm)	Pack
62352	6,70	28	6



## Sacacorchos



Autonomía / Battery life

**30**

Botellas / Bottles

### Sacacorchos eléctrico con base cargador

Tire bouchon électrique a/support charge

Korkenzieher, Elektrich mit Füllanzeige

Electric corkscrew w7charger base

Saca-rolhas Eléctrico com Base carregador

Ref	€	W	Ø (cm)	Pack
63031	32,40	1,2	12x32	10



Diseño inalámbrico, para una mayor movilidad

Calidad profesional para uso en el hogar

Funcionamiento silencioso y sin vibraciones

Extrae los corchos sin ningún esfuerzo, con rapidez y precisión solo presionando un botón

Mango ergonómico para un mejor agarre

Incluye base de recarga y un práctico descapsulador con un diseño atractivo (63054)

Conception sans fil pour une meilleure mobilité

Qualité professionnelle pour un usage à la maison

Fonctionnement silencieux et sans vibrations

Extrait les bouchons en liège sans aucun effort, rapidement et avec précision uniquement en appuyant sur un bouton.

Manche ergonomique pour une meilleure prise en main

Inclut une base de recharge et un pratique décapsuleur doté d'un design attractif (63054)

Kabelloses Design für mehr Bewegungsfreiheit

Profi-Qualität für den Hausgebrauch

Geräuscharm und vibrationlos

Öffnet Kronkorken mühelos, schnell und präzise auf Knopfdruck

Ergonomischer Griff für besseren Halt

Inhalt: Ladestation mit praktischem Kapselheber in schönem Design (63054)



**New**

Autonomía / Battery life

**30 - 40**

Botellas / Bottles

### Sacacorchos eléctrico con base cargador

Tire bouchon électrique avec support charge

Koekenzieber, Elektrich mit Füllanzeige

Electric corkscrew with charger base

Saca-rolhas eléctrico com base carregador

Ref	€	W	cm	Pack
63054	35,00	18	5x5,2x25	1



Wireless design for greater mobility

Professional quality for home use

Quiet and vibration-free operation

Extracts corks effortlessly, quickly and precisely at the push of a button

Ergonomic handle for better grip

Includes recharging stand

Handy bottle opener with attractive design (63054)

Design sem fios, para maior mobilidade

Qualidade profissional para uso doméstico

Funcionamento silencioso e sem vibrações

Com apenas pressionar um botão extraí as rolhas sem nenhum esforço, com rapidez e precisão

Mango ergonómico para melhor sujeição

Inclui base de recarga e um prático abridor de cápsulas com um atraente design (63054)



### Sacacorchos automático

Tire-bouchon automatique

Entkorker

Automatic corkscrew

saca-rolhas automático

	Ref	€	Pack
<b>A</b>	63010	264,80	1
<b>B</b>	63012	275,70	1



### Sacacorchos c/base+Descapsulador "S"

Tire-bouchon+coupe capsule S

Korkenzieher+Foliencutter S

S screwpull corkscrew w/foil cutter

Saca-rolhas com base+Descapsulador "S"

Ref	€	Pack
63026	51,80	1



**Sacacorchos negro**

Tire-bouchon  
Korkenzieher  
Zinc alloy corkscrew  
Saca-rolhas negro

Ref	€	Pack
63028	36,20	4



**Sacacorchos doble palanca**

Tire-bouchon double levier  
Korkenzieher  
Double-lever corkscrew  
Saca-rolhas dupla alavanca

Ref	€	Pack
63013	14,00	6



**Sacacorchos camarero c/navaja ?Inox 18/10**

Tire-bouchon limonadier Inox 18/10  
Kellnerkorkenzieher, Rostfrei 18/10  
Waiter's corkscrew s. steel 18/10  
Saca-rolhas con navalha Inóx 18/10

Ref	€	Pack
63018	4,30	6



**Descápsulador LUXE**

Coupe capsule LUXE  
LUXE Foliencutter  
LUXE foil cutter  
Descapsulador LUXE

Ref	€	L (cm)	Pack
63037	4,40	8	12



**Anilla anti-goteo**

Anneau stop gouttes à vin  
Weinring Trop-Stop  
Wine drip stop ring  
Anilha anti-gota

Ref	€	Ø (cm)	Pack
63019	2,40	5	6



**Boquilla servidora + Tapón**

Bec verseur + Bouchon  
Ausgiess-Aufsatz mit Verschluss,  
Spout for wine + rubber cap  
Boquilha de servir + Tampão

Ref	€	Pack
63022	3,40	6



**Embudo Silicona Expandible**

Entonnoir en silicone extensible  
Trichter, Silikon  
Silicone foldable funnel  
Funil de silicone extensível

Ref	€	Ø (cm)	Pack
68085	4,70	12	12



**Tapón champán**

Bouchon de Champagne  
Sektflaschenverschluss  
Champagne cap  
Tampão champagne

	Ref	€	Pack
<b>A</b>	63020	7,10	12
<b>B</b>	63021	5,50	12

## Bomba de vacío



Conserva el vino en perfecto estado evitando que entre aire dentro, eliminando las indeseadas burbujas y manteniendo su sabor y aroma

Mediante este sistema se retrasa el proceso de oxidación de modo que puedes disfrutar el vino en otro momento

Cierra la botella con el tapón y bombea de 10 a 20 veces (dependiendo de la cantidad de vino que haya dentro de la botella) para establecer el vacío  
Incluye bomba de vacío y dos taponos (con indicador de la fecha en la que se ha sellado la botella)

Conserve le vin en parfait état en évitant l'entrée d'air à l'intérieur, en éliminant les bulles indésirables, en conservant son goût et son arôme et en retardant le processus d'oxydation de façon à pouvoir profiter du vin à un autre moment

Refermez la bouteille avec le bouchon et pompez de 10 à 20 fois (selon la quantité de vin à l'intérieur de la bouteille) pour faire le vide

Inclut une pompe à vide et deux bouchons (avec indicateur de la date à laquelle a été scellée la bouteille)

Wein luftdicht in einwandfreiem Zustand aufbewahren, lästige Sauerstoffbläschen haben keine Chance, Geschmack und Bouquet gehen nicht verloren und der Oxidationsprozess wird verlangsamt, so dass man später den Wein erneut genießen kann  
Flasche mit Stopfen verschließen und 10 bis 20-mal Pumpen (je nach Weinmenge in der Flasche) um Restsauerstoff zu entziehen

Inhalt: Weinpumpe und 2 Stopfen (mit Flaschenverschluss mit Datumshinweis)

Keeps the wine in perfect condition by stopping air getting in, getting rid of unwanted bubbles, maintaining its flavour and aroma and delaying the oxidation process so that you can enjoy the wine at another time

Close the bottle with the stopper and pump 10 to 20 times (depending on the amount of wine inside the bottle) to establish the vacuum

Includes vacuum pump and two stoppers (with indicator of the date on which the bottle has been sealed)

Conserva o vinho em perfeito estado, evitando que o ar penetre no interior da garrafa, eliminando as indesejadas bolhas de ar, mantendo o sabor e o aroma e retardando o processo de oxidação, para que possa desfrutar do vinho noutra momento  
Feche a garrafa com o tampão e acione a bomba 10 a 20 vezes (dependendo da quantidade de vinho existente no interior da garrafa) para criar o vácuo

Inclui uma bomba de vácuo e dois tampões (com indicador de a data em que foi selada a garrafa)



### Bomba manual vacío Inox 18/10

Pompe à vide p/bouteille de vin

Weinpumpe, Rostfrei 18/10

St. Steel 18/10 wine vacuum sealer

Bomba manual vácuo Inóx 18/10

Ref	€	Pack
63033	9,00	1
R63033	2,50	2

Tapones · Stoppers



### Bomba de vacío BLACK

Pompe à vide

Weinpumpe

Vacuum pump

Bomba de vácuo

Ref	€	Ø (cm)	h (cm)	Pack
63053	9,40	4,5	14,3	1
R63053A	2,50			2

Tapones · Stoppers



## Pizarras



### Diseño tradicional

Ofrecen un espacio para que los establecimientos de hostelería expongan en sus locales como en la calle sus productos y menús

Puede ser personalizada tanto con tizas como con rotuladores

Limpieza muy sencilla, con un simple trapo húmedo

Conception traditionnelle

Offre un espace pour que les établissements d'hôtellerie qui exposent, à l'intérieur ou dans la rue, leurs produits et menus

Personnalisable aussi bien avec des craies qu'avec des feutres

Nettoyage très facile, avec un simple chiffon humide

Traditionelles Design

Bietet eine Fläche, damit die Gastronomiebetriebe in ihren Geschäften ihre Produkte und Menüs darbieten können.

Kann mit Kreide und Stiften personalisiert werden

Sehr einfache Reinigung mit einem feuchten Tuch

Traditional design

It offers a space for catering establishments to exhibit their products and menus within their premises as well as out on the street

It can be personalized with both chalk and marker pens

Very simple cleaning, with just a damp cloth

Design tradicional

Proporciona um espaço para que os estabelecimentos de hotelaria possam expor os seus produtos e menus nos locais e na rua

Personalizável com giz ou marcadores

Fácil de limpar, utilizando um pano húmido



### Sólidos caballetes

Cadena de seguridad que evita su caída

2 caras para personalizar en tiza o rotulador Lacor

Fácil de limpiar

Chevalets solides

Chaîne de sécurité pour éviter les chutes

2 côtes pour personnaliser en craie ou feutre Lacor

Facile à nettoyer



Solides Holzgestell

Sicherheitskette gegen Umkipppfah

2 Seiten anpassen Lacor-Kreide oder -Folienstift

beschreibbar

Einfach zu reinigen

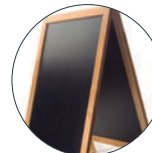

Solid frame

Safety chain to prevent from falling

2 sides to customize chalk or Lacor felt tip pens

Easy to clean

Sólidos cavaletes

Corrente de segurança para evitar eventuais quedas

2 lados para personalizar em giz ou marcador Lacor

Fácil de limpar

### Pizarra menu

Menu ardoise

Schreibtafel Menu

Menu blackboard

Quadro de menu

Ref	€	cm	Pack
39166	70,50	55x85	1
39164	102,20	65x115	1

A



B



Diseñada para ser colocada en la pared

Personalizable en tiza o rotulador Lacor

Fácil de limpiar

Conception pour une mise en place sur un mur

Personnalisable en craie ou feutre Lacor

Facile à nettoyer



Für die Wandaufhängung designt

Mit Lacor-Kreide oder -Folienstift beschreibbar

Einfach zu reinigen

Designed to be fixed on the wall

Can be personalised with chalk or Lacor felt tip pens

Easy to clean

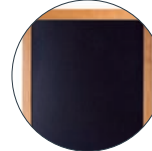

Concebido para ser colocado na parede

Personalizável em giz ou marcador Lacor

Fácil de limpar

### Pizarra menu

Menu ardoise

Schreibtafel Menu

Menu blackboard

Quadro de menu

	Ref	€	cm	Pack	
A	39162	39,80	50x80	1	Cuadrada · Square
B	39163	43,50	50x80	1	Semi-circulo · Half circle



**NO incluidos**  
NOT included

**Sistema llamativo de promoción para sus productos y ofertas  
Gran impacto visual**

Système attractif de promotion pour vos produits et offres spéciales  
Grand impact visuel

Blickfang für Produkt- und Angebotswerbung  
Starker visueller Eindruck

Eye-catching system for promoting your products and offers  
Great visual impact

Atrativo sistema de promoção para os seus produtos e ofertas  
Grande impacto visual

**Pizarra eléctrica LED**

Tableau lumineux à LED  
Elektronische LED Tafel  
Electric blackboard LED  
Ardósia LED eléctrico

	Ref	€	Pack
<b>A</b>	39140	77,30	1
<b>B</b>	39160	106,10	1

Ref	Tensión/Voltage	Potencia/Power	Funcioned/Functions	Dimensiones/Sizes	Peso/Weight
39140	220-240 V / 50-60 Hz	2 W	38	40x60 cm	2,35 Kg
39160	220-240 V / 50-60 Hz	2 W	38	60x80 cm	4,50 Kg

**Rotuladores fluorescentes 8 colores**

Marqueurs fluorescents 8 couleurs  
8-Farben fluoreszierenden marker  
4Fluorescent markers 8 colors  
Maracadores fluiorescentes 8 cores



Ref	€	cm	Pack
39161	25,50	10	1

Portamenú  
Portamenu

#CocinaConLacor

MENU

pesca del día)

media

15  
17  
16  
16

media

10  
9  
9  
9  
9  
9





**Lacor completa la colección de porta menús con 12 nuevas colecciones. Pone a la disposición del cliente la opción de personalizar cualquiera de las colecciones. La personalización se realiza mediante la técnica de estampado en caliente (Termosellado)**

Lacor complète la collection de porte-menus avec 12 nouvelles collections. Lacor propose au client la possibilité de personnaliser toutes les collections. La personnalisation est réalisée via la technique de d'estampage à chaud (Thermoscellage)

Lacor ergänzt seine Auswahl an Menümappen um 12 neue Kollektionen. Kunden können alle Menümappen von Lacor individuell anpassen. Die individuelle Gestaltung erfolgt mittels Wärmeprägung (Thermodruck)

Lacor rounds off its menu holder collection with 12 new collections. Lacor offers customers the option to customise any of the collections. Customisation is achieved by using the hot stamping technique (heat-sealing)

Lacor completa a sua coleção de porta-menús com 12 novas coleções. Lacor coloca à disposição do cliente a opção de personalizar qualquer das coleções. Personalização mediante técnica de estampado a quente (Termoselagem)

**FABRICADOS EN ESPAÑA · FABRIQUÉS EN ESPAGNE · SPANISCHER PRODUKTION · MADE IN SPAIN · FABRICADOS EN ESPHA**

**MATERIALES CERTIFICADOS · Matériaux certifiés · Zertifizierte Materialien · Authorised materials · Materiais certificados**



**SIMIL - PIEL**

**Poliuretano de gran calidad con una base de tejido sin tejer suave y ligeramente extensible. Aspecto de piel y tacto único. Gracias al material termo-virante, permite conseguir un atractivo efecto de estampado, consiguiendo diferentes colores según la temperatura que se le aplique.**

Polyuréthane de grande qualité avec une base de tissu intissé doux et légèrement extensible. Aspect cuir et toucher unique. Grâce au matériau thermo virant, l'on obtient un effet d'imprimé attractif, ainsi que différentes couleurs selon la température qui lui sera appliqué.

Hochwertiges Polyurethan mit einer nicht-gewebten Gewebebasis, weich und etwas dehnbar. Sieht wie Leder aus und fühlt sich einzigartig an. Durch das temperatursensible Material wird ein Druckeffekt mit verschiedenen Farbtönen je nach Temperatur erzeugt.

High quality polyurethane with a base of soft and slightly extendible unwoven fabric. Leather appearance and unique feel. Thanks to its heat burnishing material an attractive, printed effect is achieved, enabling different colours according to the temperature applied to it.

Poliuretano de grande qualidade, com uma base de tela não tecida suave e ligeiramente extensível. Aspeto de pele e tato único. O material sensível à temperatura permite conseguir um atrativo efeito de estampado, com diferentes cores segundo a temperatura aplicada



**TELFLEX**

**Material compuesto por un soporte celulósico recubierto con una capa vinílica de alta resistencia. Se caracteriza por su gran flexibilidad, durabilidad y resistencia a la abrasión, manchado y rayado. Acabado imitación tela.**

Matériau composé d'un support cellulosique recouvert d'une couche vinylique hautement résistante Il se caractérise par sa grande flexibilité, durabilité et résistance à l'abrasion, aux taches et aux rayures. Finition imitation tissu.

Material auf Zellulosebasis mit einer widerstandsfähigen Vinylbeschichtung. Es zeichnet sich durch seine hohe Flexibilität, Haltbarkeit und Widerstandsfähigkeit gegen Reibung, Flecken und Kratzer aus. Oberfläche aus Stoff-Imitat

A material comprised of a cellulose-based support covered with a high resistance vinyl layer. Characterised by its great flexibility, durability and resistance to abrasion, stains and scratches. Imitation fabric finish.

Material composto por um suporte celulósico revestido com uma camada vinílica de alta resistência. Carateriza-se pela sua grande flexibilidade, durabilidade e resistência à abrasão, às manchas e aos riscos. Acabamento a imitar tela.

**NOTA · NOTE**

La limpieza deberá realizarse con un paño húmedo, pero no saturado de agua. Evite el contacto y la inmersión en agua. Evite manipularlo con las manos mojadas. NO aptos para el lavavajillas

The cleaning should be done with a damp cloth, but not saturated with water. Avoid contact and immersion in water. Avoid handling with wet hands. NOT suitable for dishwashers

**PERSONALIZACIÓN · Personnalisation · Individuelle Anpassung · Customisation · Personalização**

**Lacor pone a disposición del cliente la opción de personalizar cualquiera de las 38 colecciones. La personalización se realiza mediante la técnica de estampado en caliente ( termosellado). El logotipo deberá ser enviado vectorizado en formato Adobe Illustrator sino el vectorizado del sello se cobrará 20 €.**

**Se debe indicar tanto el posicionamiento como el color entre las siguientes opciones:**

Lacor propose au client la possibilité de personnaliser n'importe laquelle des 38 collections. La personnalisation est réalisée selon la technique d'estampage à chaud (Thermoscellage). Pour ce faire, le logo devra être envoyé vectorisé en format Adobe Illustrator mais la vectorisation du timbre sera facturée 20 €. Il est nécessaire d'indiquer aussi bien le positionnement que la couleur parmi les options suivantes :

Lacor ermöglicht dem Kunden die individuelle Anpassung jeder der 38 Kollektionen. Die individuelle Anpassung erfolgt mittels Heißprägung. Das Logo muss zu diesem Zweck als Vektorgrafik im Format Adobe Illustrator bereitgestellt werden sondern die Vektorisierung der Briefmarke wird mit € 20 berechnet. Aus den folgenden Optionen muss die Position und die Farbe ausgewählt werden:

Lacor offers clients the option of customising any of its 88 collections. Customisation is performed via hot stamping. The logo must be sent in vector format using Adobe Illustrator but the vectorization of the stamp will be charged 20€. Both the position and the colour of the logo must be indicated, choosing from the following options:

Lacor oferece ao cliente a opção de personalizar qualquer das 38 coleções. A personalização é feita utilizando a técnica de estampado a quente (termoselagem), devendo o utilizador enviar o logótipo vetorizado, em formato Adobe Illustrator mas a vectorização do carimbo será cobrado 20€. Indicar tanto o posicionamento como a cor, entre as seguintes opções:

**Precio · Tarif · Preisliste · Cost · Custo:**

España & Portugal: 39€ / Francia: 44€ ( a partir de 15 unidades)  
 Espagne & Portugal: 39€ / France: 44€ (à partir de 15 unités)  
 Spanje & Portugal: 39€ / Frankrijk: 44€ ( ab 15 Einheiten)  
 Spain & Portugal: 39€ / France: 44€ ( minimum 15 units)  
 Espanha & Portugal: 39€ / França: 44€ ( a partir de 15 unidades)

**Posicionamiento orientativo**

Guidance position

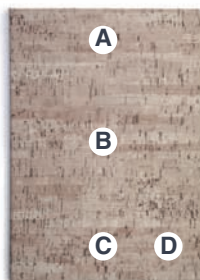

A: Óptico · Optical  
 B: Centro · Centre  
 C: Pie centro · Bottom centre  
 D: Pie drecho · Bottom right

**Color**

Coleur· Farbe · Colour· Cor

- En seco (sin color) · Dry (without colour)
- Blanco · White
- Negro · Black
- Rojo · Red
- Oro · Gold
- Plata · Silver
- Crema · Cream

**NOTA · NOTE:**

**El plazo de entrega para los Portamenús Personalizados es de 15 días naturales**

The delivery period for the Personal Portamenús is 15 calendar days

**NOTA · NOTE**

**NO se recomienda la estampación en seco en las colecciones · Dry printing is NOT recommended in the collections:**

ANDRÉ · MATISSE · CHARLOTTE · DEGAS · CASSAT · EDGAR · MAURICE · SOPHIE · PAUL · CÉLINE · MONET · GOYA · MARCEL · ANDY · PAOLO





Fijaciones Interiores · Fixation Intérieure · Innere Befestigung · Interior Fixings · Fixação Interior

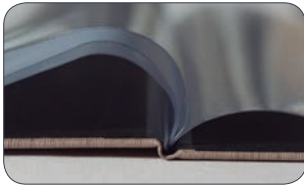

**FUNDAS fijas PVC**

Protège-feuilles PVC · PVC hüllen · PVC covers · Capa de PVC

**Fundas fijas de PVC en piel de naranja. Altamente resistentes**

Protège-feuilles fixes en PVC en peau d'orange. Hautement résistantes  
Hüllen aus PVC in Orangenhaut Sehr widerstandsfähig  
Highly resistant, fixed frosted PVC covers  
Capas fixas de PVC a imitar pele de laranja. Altamente resistentes



**SOLAPAS fijas**

Rabats fixes · Feste Klappen · Fixed flaps · Abas fixas

**Solapas fijas a la cubierta**

Rabats fixes sur la couverture  
Am Einband befestigte Klappen  
Flaps fixed to the cover  
Abas fixas à cobertura



**ATORNILLADO interior**

Vissage intérieur · Innere verschraubung · Screwed interior · Aparafusamento interior

**Atornillado interior permite añadir o cambiar hojas o fundas según necesidad del cliente**

Vissage intérieur pour intégrer des feuilles ou des protège-feuilles selon les besoins de l'utilisateur  
Innere Verschraubung zur Anbringung von Blättern oder Hüllen, je nach Bedarf des Benutzers  
Screwed interior to include pages or covers, according to the user's needs  
Aparafusamento interior para incluir lâminas ou capas, segundo as necessidades do utilizador



**ATORNILLADO exterior**

Vissage extérieur · Äußere verschraubung · Screwed exterior · Aparafusamento exterior

**Atornillado exterior permite añadir hojas o fundas según necesidad del cliente**

Vissage extérieur pour intégrer des feuilles ou des protège-feuilles selon les besoins de l'utilisateur  
Äußere Verschraubung zur Anbringung von Blättern oder Hüllen, je nach Bedarf des Benutzers  
Screwed exterior to include pages or covers, according to the user's needs  
Aparafusamento exterior para incluir lâminas ou capas, segundo as necessidades do utilizador



**PINZA**

Pince · Klammer · Clip · Pinça

**Con pinza metálica de color plata que sujeta la hoja del menú**

Doté d'une pince métallique couleur argent qui tient la feuille du menu  
Mit silberner Klammer aus Metall als Menühalter  
With a silver-coloured metal clip that holds the menu in place  
Com pinça metálica prateada para sujeitar a folha do menu

**New**

Accesorios · Accessoires · Zubehör · Accessories · Acessórios

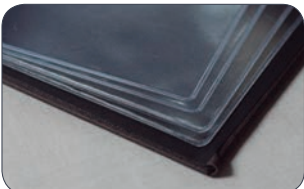

**Set 10 fundas interiores PVC Piel de naranja**

Jeu 10 feuilles intérieures PVC Peau d'Orange  
10 Tlg. Innere Blätter, PVC, Orangenhaut  
Set 10 interior frosted PVC pages  
Set 10 lâminas interiores de PVC Pele de Laranja

Ref	€	cm	Pack	
28191	9,90	21x29,7 (A4)	10	Ref.: 28500 , 28510, 28520, 28530
28192	7,70	14x26	10	
28193	7,80	18,8x21 (A5)	10	
28194	9,90	21x29,7 (A4)	10	Ref.: 28550, 28540
28203	10,10	25x32(A4)	10	Ref.: 28211, 28231, 28251

**New**



**Set 12 cantoneras**

Jeu 12 coins  
12 Tlg. Kantenschutz  
Set 12 angle irons  
Set 12 cantoneiras

Ref	€	Color	Pack
28195	4,30	Negro · Black	12
28197	4,30	Oro · Gold	12
28198	4,30	Plata · Silver	12



**Set 12 tornillos**

Jeu 12 vis  
12 Tlg. Schrauben  
Set 12 screws  
Set 12 parafusos

Ref	€	Color	Pack
28196	8,90	Plata · Silver	12
28199	9,20	Negro · Black	12



## Isabelle



**Fabricado en Simil - Piel  
Termosellado en color Plata**

Fabriqué en cuir Simili - Cuir  
Thermoscage en couleur Argent

Hergestellt aus Lederimitat  
Die Heißprägung ist in den Farben silbern

Manufactured in imitation leather  
Heat stamping in Silver

Fabricado em Símil - Pele  
Termoselagem disponível nas cores Prata

**Porta menú**

Porte-menu  
Speisekartenmappe  
Menu cover  
Porta menu

	Ref	€	cm	Fundas	Pack
<b>A</b>	28001	22,30	23x32 (A4)	6	4
<b>B</b>	28002	16,70	16x28,5	4	4
<b>C</b>	28003	17,50	17x23,5 (A5)	4	4



**Fundas fijas de PVC en piel de naranja. Altamente resistentes**  
Highly resistant, fixed frosted PVC covers

## Frida



**Fabricado en Simil - Piel  
Termosellado en color Negro**

Fabriqué en cuir Simili - Cuir  
Thermoscage en couleur Noir

Hergestellt aus Lederimitat  
Die Heißprägung ist in den Farben schwarz

Manufactured in imitation leather  
Heat stamping in Black

Fabricado em Símil - Pele  
Termoselagem disponível nas cores Negro

**Porta menú**

Porte-menu  
Speisekartenmappe  
Menu cover  
Porta menu

	Ref	€	cm	Fundas	Pack
<b>A</b>	28011	20,60	23x32 (A4)	4	4
<b>B</b>	28012	15,70	16x28,5	4	4
<b>C</b>	28013	16,50	17x23,5 (A5)	4	4

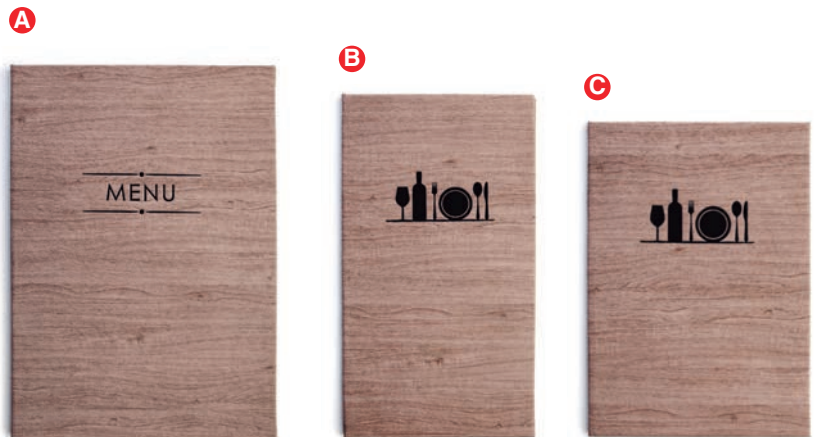

**Fundas fijas de PVC en piel de naranja. Altamente resistentes**  
Highly resistant, fixed frosted PVC covers

## Veemer



**Fabricado en Simil - Piel  
Termosellado en color Negro**

Fabriqué en cuir Simili - Cuir  
Thermoscage en couleur Noir

Hergestellt aus Lederimitat  
Die Heißprägung ist in den Farben schwarz

Manufactured in imitation leather  
Heat stamping in Black

Fabricado em Símil - Pele  
Termoselagem disponível nas cores Negro

**Porta menú**

Porte-menu  
Speisekartenmappe  
Menu cover  
Porta menu

	Ref	€	cm	Fundas	Pack
<b>A</b>	28500	31,90	25,5x32 (A4)	3	4
<b>B</b>	28501	27,10	18x28,5	3	4
<b>C</b>	28502	27,70	19x23,5 (A5)	3	4



**Atornillado interior permite añadir o cambiar hojas o fundas según necesidad del cliente**  
Screwed interior to include pages or covers, according to the user's needs



## René



**Fabricado en Simil - Piel  
Termosellado en color Crema**

Fabriqué en cuir Simili - Cuir  
Thermoscellage en couleur Crème

Hergestellt aus Lederimitat  
Die Heißprägung ist in den Farben cremefarben

Manufactured in imitation leather  
Heat stamping in Cream

Fabricado em Símil - Pele  
Termoselagem disponível nas cores Creme

**Porta menú**

Porte-menu  
Speisekartenmappe  
Menu cover  
Porta menu



	Ref	€	cm	Fundas	Pack
<b>A</b>	28021	20,60	23x32 (A4)	4	4
<b>B</b>	28022	15,70	16x28,5	4	4
<b>C</b>	28023	16,50	17x23,5 (A5)	4	4

**Fundas fijas de PVC en piel de naranja. Altamente resistentes**  
Highly resistant, fixed frosted PVC covers

## Nicolás



**Fabricado en Simil - Piel  
Termosellado en color Crema**

Fabriqué en cuir Simili - Cuir  
Thermoscellage en couleur Crème

Hergestellt aus Lederimitat  
Die Heißprägung ist in den Farben cremefarber

Manufactured in imitation leather  
Heat stamping in Cream

Fabricado em Símil - Pele  
Termoselagem disponível nas cores Creme

**Porta menú**

Porte-menu  
Speisekartenmappe  
Menu cover  
Porta menu

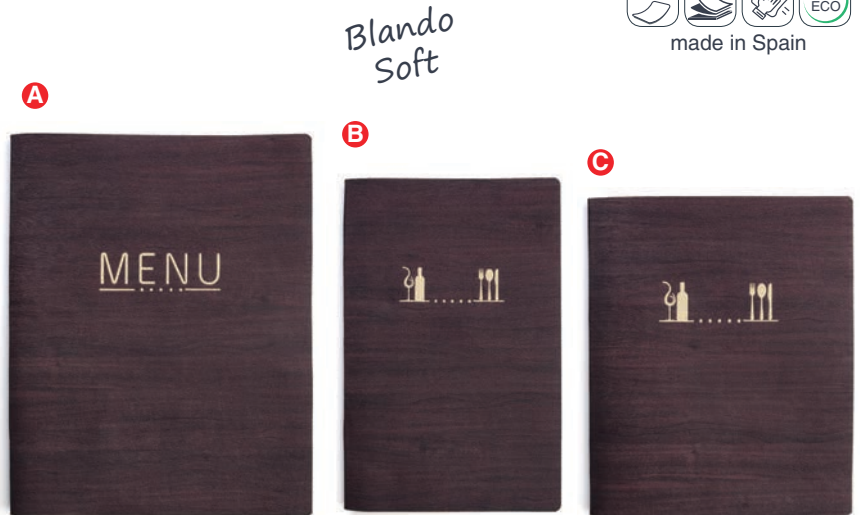

	Ref	€	cm	Fundas	Pack
<b>A</b>	28510	31,90	25,5x32 (A4)	3	4
<b>B</b>	28511	27,10	18x28,5	3	4
<b>C</b>	28512	27,70	19x23,5 (A5)	3	4

**Atornillado interior permite añadir o cambiar hojas o fundas según necesidad del cliente**  
Screwed interior to include pages or covers, according to the user's needs

## André



**Fabricado en Telflex  
Termosellado en color Crema**

Fabriqué en cuir Telflex  
Thermoscellage en couleur Crème

Hergestellt aus Telflex  
Die Heißprägung ist in den Farben cremefarben

Manufactured in Telflex  
Heat stamping in Cream

Fabricado em Telflex  
Termoselagem disponível nas cores Creme

**Porta menú**

Porte-menu  
Speisekartenmappe  
Menu cover  
Porta menu

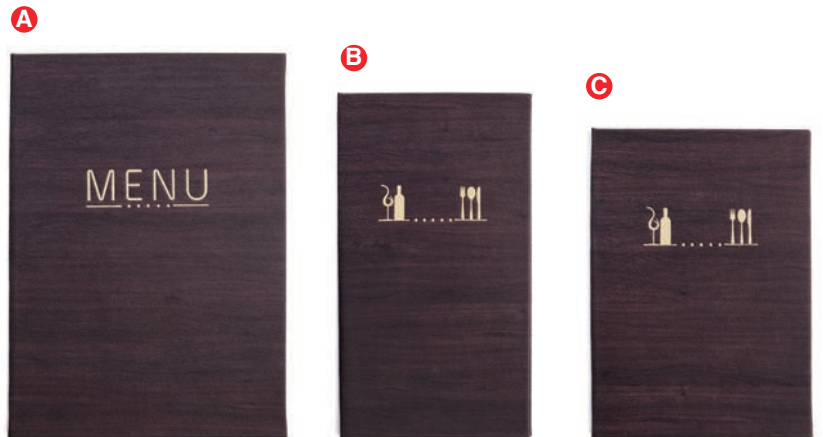

	Ref	€	cm	Fundas	Pack
<b>A</b>	28031	17,90	23x32 (A4)	4	4
<b>B</b>	28032	13,50	16x28,5	4	4
<b>C</b>	28033	14,00	17x23,5 (A5)	4	4

**Fundas fijas de PVC en piel de naranja. Altamente resistentes**  
Highly resistant, fixed frosted PVC covers





## Cézanne



**Fabricado en Simil - Piel  
Termosellado en color Crema**

Fabriqué en cuir Simili - Cuir  
Thermoscellage en couleur Crème

Hergestellt aus Lederimitat  
Die Heißprägung ist in den Farbencremefarber

Manufactured in imitation leather  
Heat stamping in Cream

Fabricado em Símil - Pele  
Termoselagem disponível nas cores Creme



**Solapas fijas a la cubierta**  
Flaps fixed to the cover

**Porta menú**  
Porte-menu  
Speisekartenmappe  
Menu cover  
Porta menu

Ref	€	cm	Pack
28041	16,00	23x32 (A4)	4

## Matisse



**Fabricado en Simil - Piel  
Termosellado en color Negro**

Fabriqué en cuir Simili - Cuir  
Thermoscellage en couleur Noir

Hergestellt aus Lederimitat  
Die Heißprägung ist in den Farben schwarz

Manufactured in imitation leather  
Heat stamping in Black

Fabricado em Símil - Pele  
Termoselagem disponível nas cores Negro

**Porta menú**  
Porte-menu  
Speisekartenmappe  
Menu cover  
Porta menu

	Ref	€	cm	Fundras	Pack
<b>A</b>	28051	20,60	23x32 (A4)	4	4
<b>B</b>	28052	15,70	16x28,5	4	4
<b>C</b>	28053	16,50	17x23,5 (A5)	4	4

**A**



**B**



**C**



**Fundras fijas de PVC en piel de naranja. Altamente resistentes**  
Highly resistant, fixed frosted PVC covers

## Charlotte



**Fabricado en Simil - Piel  
Termosellado en color Negro**

Fabriqué en cuir Simili - Cuir  
Thermoscellage en couleur Noir

Hergestellt aus Lederimitat  
Die Heißprägung ist in den Farben schwarz

Manufactured in imitation leather  
Heat stamping in Black

Fabricado em Símil - Pele  
Termoselagem disponível nas cores Negro

**Porta menú**  
Porte-menu  
Speisekartenmappe  
Menu cover  
Porta menu

	Ref	€	cm	Fundras	Pack
<b>A</b>	28530	31,90	25,5x32 (A4)	3	4
<b>B</b>	28531	27,70	18x28,5	3	4
<b>C</b>	28532	27,10	19x23,5 (A5)	3	4

**A**



**B**



**C**



**Atornillado interior permite añadir o cambiar hojas o fundras según necesidad del cliente**  
Screwed interior to include pages or covers, according to the user's needs

Blando  
Soft





## Degas



made in Spain



**Fabricado en Simil - Piel  
Termosellado en color Negro**

Fabriqu  en cuir Simili - Cuir  
Thermoscillage en couleur Noir

Hergestellt aus Lederimitat  
Die Hei pr gung ist in den Farben schwarz

Manufactured in imitation leather  
Heat stamping in Black

Fabricado em S mil - Pele  
Termoselagem dispon vel nas cores Negro



**Solapas fijas a la cubierta**  
Flaps fixed to the cover

**Porta men **  
Porte-menu  
Speisekartenmappe  
Menu cover  
Porta menu

Ref	�	cm	Pack
28141	18,80	23x32 (A4)	4

## Cassat



made in Spain



**Fabricado en Telflex  
Termosellado en color Negro**

Fabriqu  en cuir Telflex  
Thermoscillage en couleur Noir

Hergestellt aus Telflex  
Die Hei pr gung ist in den Farben schwarz

Manufactured in Telflex  
Heat stamping in Black

Fabricado em Telflex  
Termoselagem dispon vel nas cores Negro

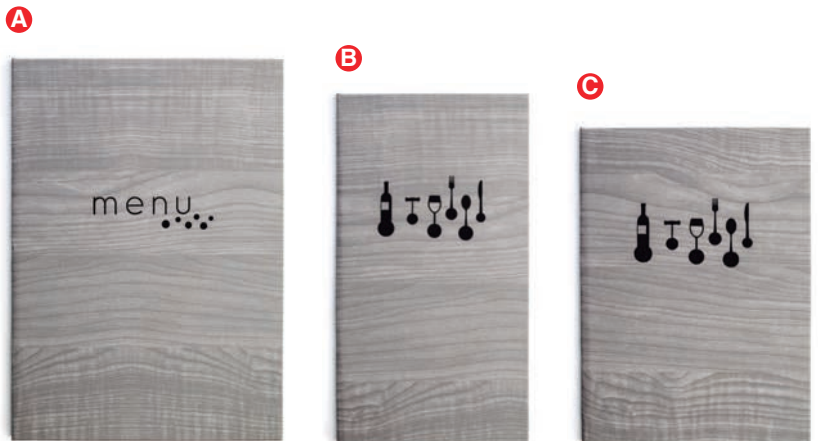

**Fundas fijas de PVC en piel de naranja. Altamente resistentes**  
Highly resistant, fixed frosted PVC covers

**Porta men **  
Porte-menu  
Speisekartenmappe  
Menu cover  
Porta menu

	Ref	�	cm	Fundas	Pack
<b>A</b>	28061	17,90	23x32 (A4)	4	4
<b>B</b>	28062	13,50	16x28,5	4	4
<b>C</b>	28063	14,00	17x23,5 (A5)	4	4

## Edgar



made in Spain



**Fabricado en Telflex  
Termosellado en color Negro**

Fabriqu  en cuir Telflex  
Thermoscillage en couleur Noir

Hergestellt aus Telflex  
Die Hei pr gung ist in den Farben schwarz

Manufactured in Telflex  
Heat stamping in Black

Fabricado em Telflex  
Termoselagem dispon vel nas cores Negro



**Atornillado exterior permite a adir hojas o fundas seg n necesidad del cliente**  
Screwed exterior to include pages or covers, according to the user's needs

**Porta men **  
Porte-menu  
Speisekartenmappe  
Menu cover  
Porta menu

Ref	�	cm	Fundas	Pack
28540	17,70	25,5x32(A4)	3	4



## Maurice



made in Spain



**Fabricado en Telflex**  
**Termosellado en color Rojo**

Fabriqué en cuir Telflex  
Thermoscillage en couleur Rouge

Hergestellt aus Telflex  
Die Heißprägung ist in den Farben rot

Manufactured in Telflex  
Heat stamping in Red

Fabricado em Telflex  
Termoselagem disponível nas cores Vermelho

**Porta menú**

Porte-menu  
Speisekartenmappe  
Menu cover  
Porta menu

	Ref	€	cm	Fundas	Pack
<b>A</b>	28071	18,50	23x32 (A4)	4	4
<b>B</b>	28072	13,90	16x28,5	4	4
<b>C</b>	28073	14,40	17x23,5 (A5)	4	4

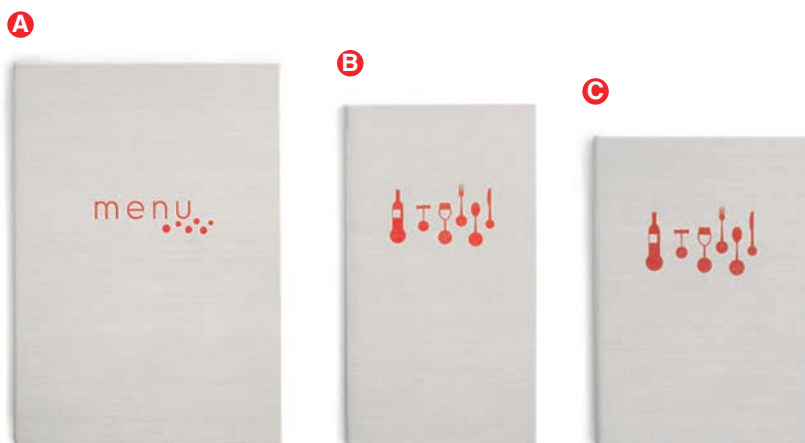

**Fundas fijas de PVC en piel de naranja. Altamente resistentes**  
Highly resistant, fixed frosted PVC covers

## Sophie



made in Spain



**Fabricado en Telflex**  
**Termosellado en color Negro**

Fabriqué en cuir Telflex  
Thermoscillage en couleur Noir

Hergestellt aus Telflex  
Die Heißprägung ist in den Farben schwarz

Manufactured in Telflex  
Heat stamping in Black

Fabricado em Telflex  
Termoselagem disponível nas cores Negro

**Porta menú**

Porte-menu  
Speisekartenmappe  
Menu cover  
Porta menu

	Ref	€	cm	Fundas	Pack
<b>A</b>	28081	18,50	23x32 (A4)	4	4
<b>B</b>	28082	13,90	16x28,5	4	4
<b>C</b>	28083	14,40	17x23,5 (A5)	4	4

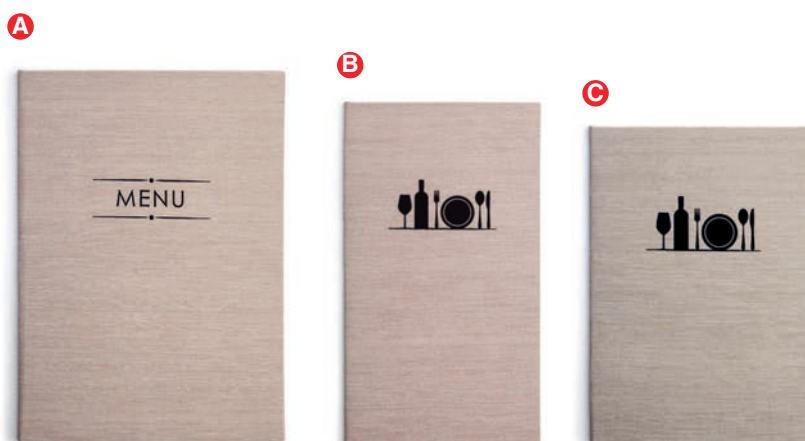

**Fundas fijas de PVC en piel de naranja. Altamente resistentes**  
Highly resistant, fixed frosted PVC covers

## Paul



made in Spain



**Fabricado en Telflex**  
**Termosellado en color Negro**

Fabriqué en cuir Telflex  
Thermoscillage en couleur Noir

Hergestellt aus Telflex  
Die Heißprägung ist in den Farben schwarz

Manufactured in Telflex  
Heat stamping in Black

Fabricado em Telflex  
Termoselagem disponível nas cores Negro

**Porta menú**

Porte-menu  
Speisekartenmappe  
Menu cover  
Porta menu

	Ref	€	cm	Fundas	Pack
	28550	20,40	25,5x32(A4)	3	4



**Atornillado exterior permite añadir hojas o fundas según necesidad del cliente**  
Screwed exterior to include pages or covers, according to the user's needs



## Céline



made in Spain



**Fabricado en Simil - Piel  
Termosellado en color Oro**

Fabriqué en cuir Simili - Cuir  
Thermoscellage en couleur Or

Hergestellt aus Lederimitat  
Die Heißprägung ist in den Farben golden

Manufactured in imitation leather  
Heat stamping in Gold

Fabricado em Símil - Pele  
Termoselagem disponível nas cores Ouro

**Porta menú**

Porte-menu  
Speisekartenmappe  
Menu cover  
Porta menu



**Fundas fijas de PVC en piel de naranja. Altamente resistentes**  
Highly resistant, fixed frosted PVC covers

	Ref	€	cm	Fundas	Pack
<b>A</b>	28091	19,20	23x32 (A4)	4	4
<b>B</b>	28092	14,70	16x28,5	4	4
<b>C</b>	28093	15,40	17x23,5 (A5)	4	4

## Dalí



made in Spain



**Fabricado en Simil - Piel  
Termosellado en color Blanco**

Fabriqué en cuir Simili - Cuir  
Thermoscellage en couleur Blanc

Hergestellt aus Lederimitat  
Die Heißprägung ist in den Farben weiß

Manufactured in imitation leather  
Heat stamping in White

Fabricado em Símil - Pele  
Termoselagem disponível nas cores Branco

**Porta menú**

Porte-menu  
Speisekartenmappe  
Menu cover  
Porta menu

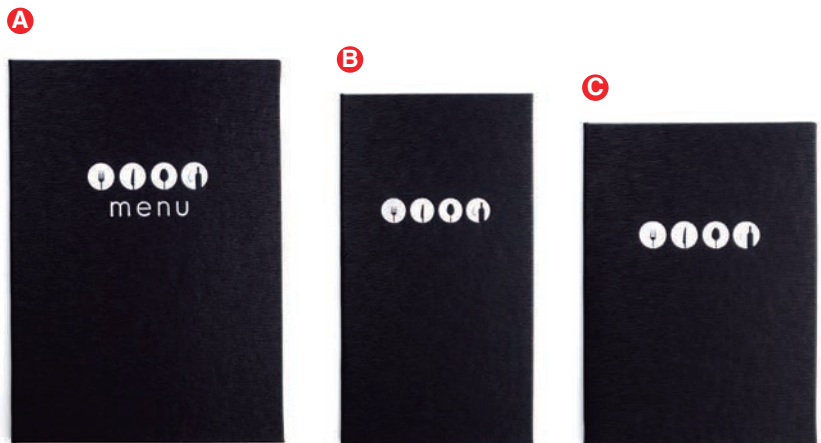

**Fundas fijas de PVC en piel de naranja. Altamente resistentes**  
Highly resistant, fixed frosted PVC covers

	Ref	€	cm	Fundas	Pack
<b>A</b>	28101	19,20	23x32 (A4)	4	4
<b>B</b>	28102	14,70	16x28,5	4	4
<b>C</b>	28103	15,40	17x23,5 (A5)	4	4

## Henry



made in Spain



**Fabricado en Simil - Piel  
Termosellado en color Blanco**

Fabriqué en cuir Simili - Cuir  
Thermoscellage en couleur Blanc

Hergestellt aus Lederimitat  
Die Heißprägung ist in den Farben weiß

Manufactured in imitation leather  
Heat stamping in White

Fabricado em Símil - Pele  
Termoselagem disponível nas cores Branco

Blando  
Soft

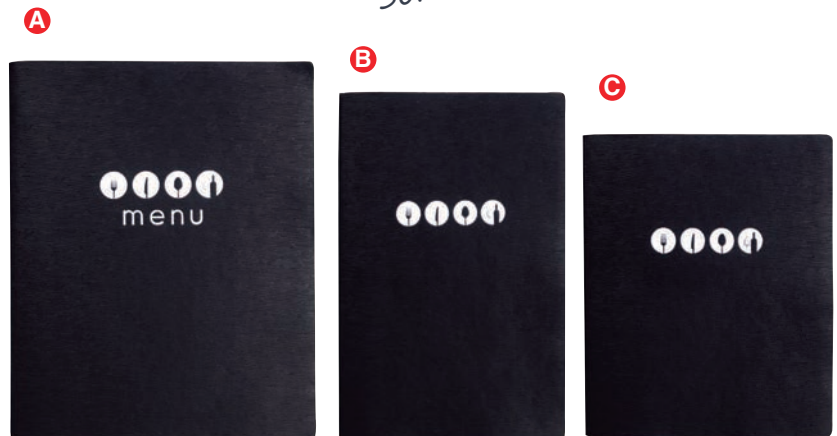

**Atornillado interior permite añadir o cambiar hojas o fundas según necesidad del cliente**  
Screwed interior to include pages or covers, according to the user's needs

**Porta menú**

Porte-menu  
Speisekartenmappe  
Menu cover  
Porta menu

	Ref	€	cm	Fundas	Pack
<b>A</b>	28520	28,50	25,5x32 (A4)	3	4
<b>B</b>	28521	24,80	18x28,5	3	4
<b>C</b>	28522	25,20	19x23,5 (A5)	3	4





## Marie



**Fabricado en Simil - Piel  
Termosellado en color Blanco**

Fabriqué en cuir Simili - Cuir  
Thermoscillage en couleur Blanc

Hergestellt aus Lederimitat  
Die Heißprägung ist in den Farben weiß

Manufactured in imitation leather  
Heat stamping in White

Fabricado em Simil - Pele  
Termoselagem disponível nas cores Branco



made in Spain



**Porta menú**

Porte-menu  
Speisekartenmappe  
Menu cover  
Porta menu

Ref	€	cm	Pack
28560	16,90	23x32 (A4)	4

**Solapas fijas a la cubierta**  
Flaps fixed to the cover

## Simón



**Fabricado en Telflex  
Termosellado en color Plata**

Fabriqué en cuir Telflex  
Thermoscillage en couleur Argent

Hergestellt aus Telflex  
Die Heißprägung ist in den Farben silbern

Manufactured in Telflex  
Heat stamping in Silver

Fabricado em Telflex  
Termoselagem disponível nas cores Prata



made in Spain

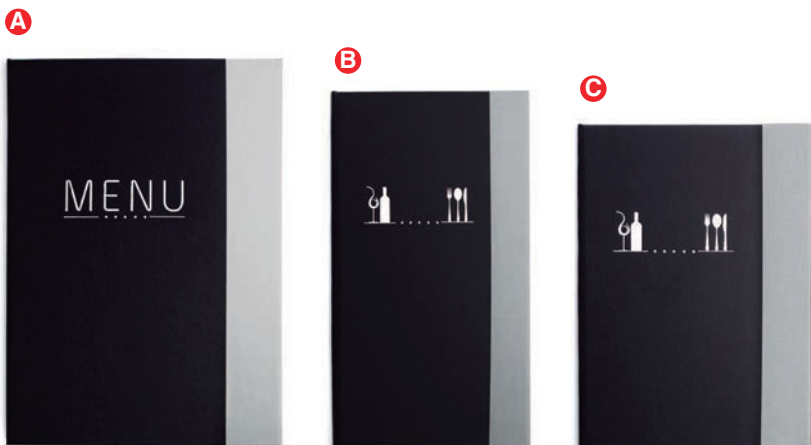

**Porta menú**

Porte-menu  
Speisekartenmappe  
Menu cover  
Porta menu

	Ref	€	cm	Fundas	Pack
<b>A</b>	28111	19,50	23x32 (A4)	4	4
<b>B</b>	28112	15,10	16x28,5	4	4
<b>C</b>	28113	15,60	17x23,5 (A5)	4	4

**Fundas fijas de PVC en piel de naranja. Altamente resistentes**  
Highly resistant, fixed frosted PVC covers

## Monet



**Fabricado en Telflex  
Termosellado en color Negro**

Fabriqué en cuir Telflex  
Thermoscillage en couleur Noir

Hergestellt aus Telflex  
Die Heißprägung ist in den Farben schwarz

Manufactured in Telflex  
Heat stamping in Black

Fabricado em Telflex  
Termoselagem disponível nas cores Negro



made in Spain

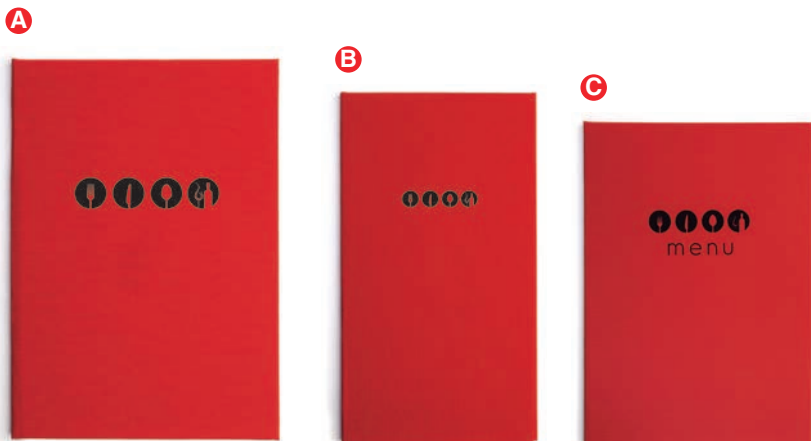

**Porta menú**

Porte-menu  
Speisekartenmappe  
Menu cover  
Porta menu

	Ref	€	cm	Fundas	Pack
<b>A</b>	28121	17,90	23x32 (A4)	4	4
<b>B</b>	28122	13,50	16x28,5	4	4
<b>C</b>	28123	14,00	17x23,5 (A5)	4	4

**Fundas fijas de PVC en piel de naranja. Altamente resistentes**  
Highly resistant, fixed frosted PVC covers





## Millet



made in Spain



**Fabricado en Simil - Piel  
Termosellado en color Negro**

Fabriqué en cuir Simili - Cuir  
Thermoscage en couleur Noir

Hergestellt aus Lederimitat  
Die Heißprägung ist in den Farben schwarz

Manufactured in imitation leather  
Heat stamping in Black

Fabricado em Símil - Pele  
Termoselagem disponível nas cores Negro

**Porta menú**

Porte-menu  
Speisekartenmappe  
Menu cover  
Porta menu

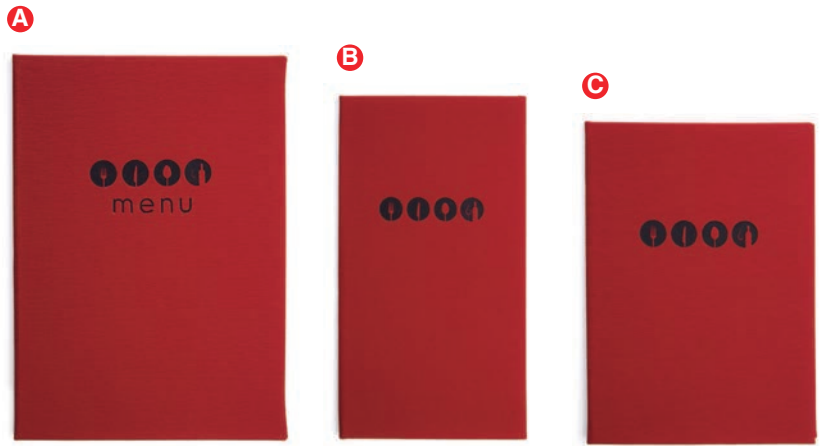

	Ref	€	cm	Fundas	Pack
<b>A</b>	28131	19,20	23x32 (A4)	4	4
<b>B</b>	28132	14,70	16x28,5	4	4
<b>C</b>	28133	15,40	17x23,5 (A5)	4	4

**Fundas fijas de PVC en piel de naranja. Altamente resistentes**  
Highly resistant, fixed frosted PVC covers

## Pablo

**New**



made in Spain



**Fabricado en Simil - Piel  
Termosellado en color Blanco**

Fabriqué en cuir Simili - Cuir  
Thermoscage en couleur Blanc

Hergestellt aus Lederimitat  
Die Heißprägung ist in den Farben weiß

Manufactured in imitation leather  
Heat stamping in White

Fabricado em Símil - Pele  
Termoselagem disponível nas cores Branco

**Porta menú**

Porte-menu  
Speisekartenmappe  
Menu cover  
Porta menu

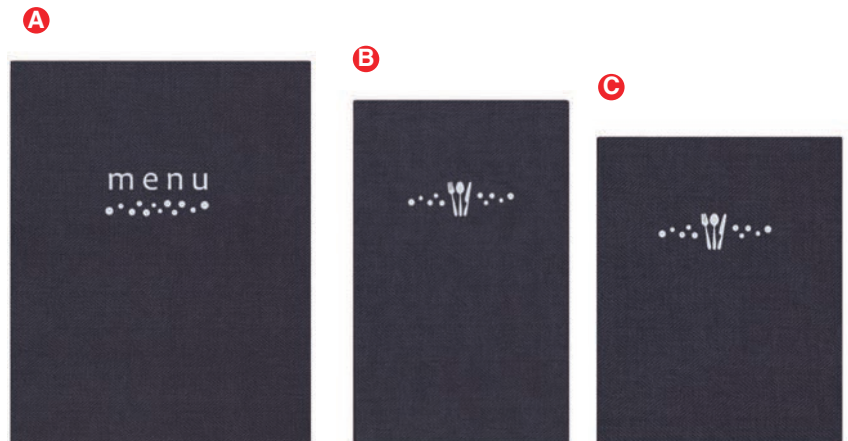

	Ref	€	cm	Fundas	Pack
<b>A</b>	28211	25,30	25x32 (A4)	3	4
<b>B</b>	28212	21,20	18x28	3	4
<b>C</b>	28213	20,40	19,5x23,5 (A5)	3	4

**Atornillado interior permite añadir o cambiar hojas o fundas según necesidad del cliente**  
Screwed interior to include pages or covers, according to the user's needs

## Albert

**New**



made in Spain



**Fabricado en Simil - Piel  
Termosellado en color Blanco**

Fabriqué en cuir Simili - Cuir  
Thermoscage en couleur Blanc

Hergestellt aus Lederimitat  
Die Heißprägung ist in den Farben weiß

Manufactured in imitation leather  
Heat stamping in White

Fabricado em Símil - Pele  
Termoselagem disponível nas cores Branco

**Porta menú**

Porte-menu  
Speisekartenmappe  
Menu cover  
Porta menu

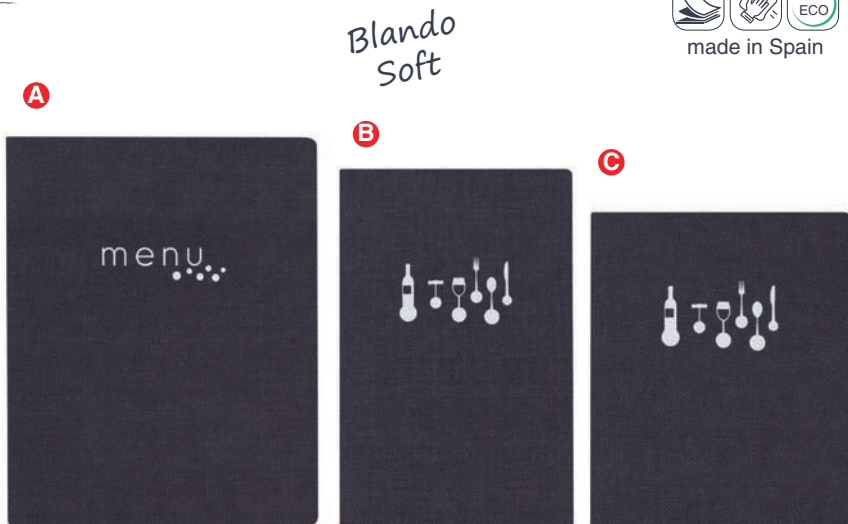

	Ref	€	cm	Fundas	Pack
<b>A</b>	28221	31,20	25,5x32 (A4)	3	4
<b>B</b>	28222	27,30	18x28	3	4
<b>C</b>	28223	26,50	19,5x23,5 (A5)	3	4

**Atornillado interior permite añadir o cambiar hojas o fundas según necesidad del cliente**  
Screwed interior to include pages or covers, according to the user's needs



## Francis

**New**



made in Spain



**Fabricado en Simil - Piel  
Termosellado en color Blanco**

Fabriqué en cuir Simili - Cuir  
Thermoscillage en couleur Blanc

Hergestellt aus Lederimitat  
Die Heißprägung ist in den Farben weiß

Manufactured in imitation leather  
Heat stamping in White

Fabricado em Símil - Pele  
Termoselagem disponível nas cores Branco

**Porta menú**

Porte-menu  
Speisekartenmappe  
Menu cover  
Porta menu

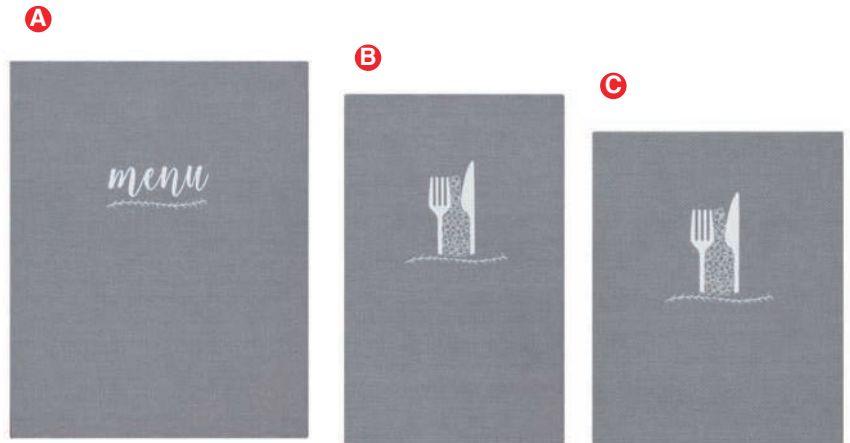

	Ref	€	cm	Fundas	Pack
<b>A</b>	28231	25,30	25x32 (A4)	3	4
<b>B</b>	28232	21,20	18x28	3	4
<b>C</b>	28233	20,40	19,5x23,5 (A5)	3	4

**Atornillado interior permite añadir o cambiar hojas o fundas según necesidad del cliente**  
Screwed interior to include pages or covers, according to the user's needs

## Vicent

**New**



made in Spain



**Fabricado en Simil - Piel  
Termosellado en color Blanco**

Fabriqué en cuir Simili - Cuir  
Thermoscillage en couleur Blanc

Hergestellt aus Lederimitat  
Die Heißprägung ist in den Farben weiß

Manufactured in imitation leather  
Heat stamping in White

Fabricado em Símil - Pele  
Termoselagem disponível nas cores Branco

**Porta menú**

Porte-menu  
Speisekartenmappe  
Menu cover  
Porta menu

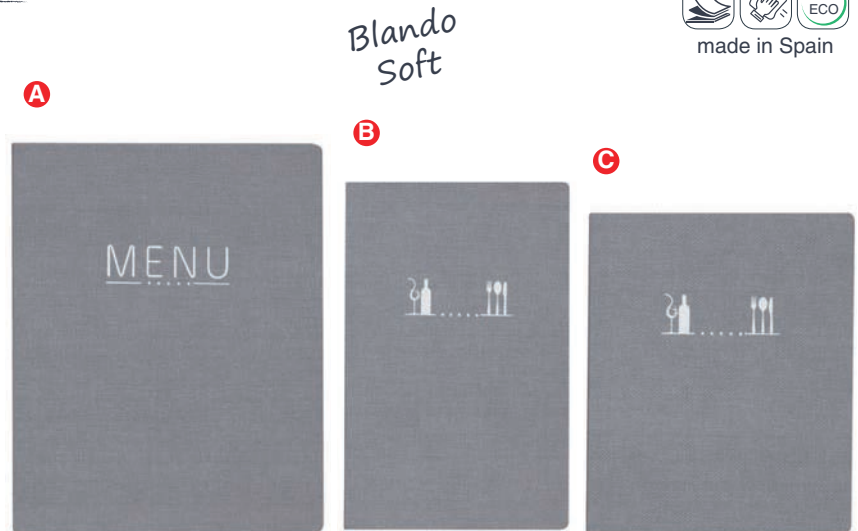

	Ref	€	cm	Fundas	Pack
<b>A</b>	28241	31,20	25,5x32 (A4)	3	4
<b>B</b>	28242	27,30	18x28	3	4
<b>C</b>	28243	26,50	19,5x23,5 (A5)	3	4

**Atornillado interior permite añadir o cambiar hojas o fundas según necesidad del cliente**  
Screwed interior to include pages or covers, according to the user's needs

## Piero

**New**



made in Spain



**Fabricado en Simil - Piel  
Termosellado en color Negro**

Fabriqué en cuir Simili - Cuir  
Thermoscillage en couleur Noir

Hergestellt aus Lederimitat  
Die Heißprägung ist in den Farben schwarz

Manufactured in imitation leather  
Heat stamping in Black

Fabricado em Símil - Pele  
Termoselagem disponível nas cores Negro

**Porta menú**

Porte-menu  
Speisekartenmappe  
Menu cover  
Porta menu

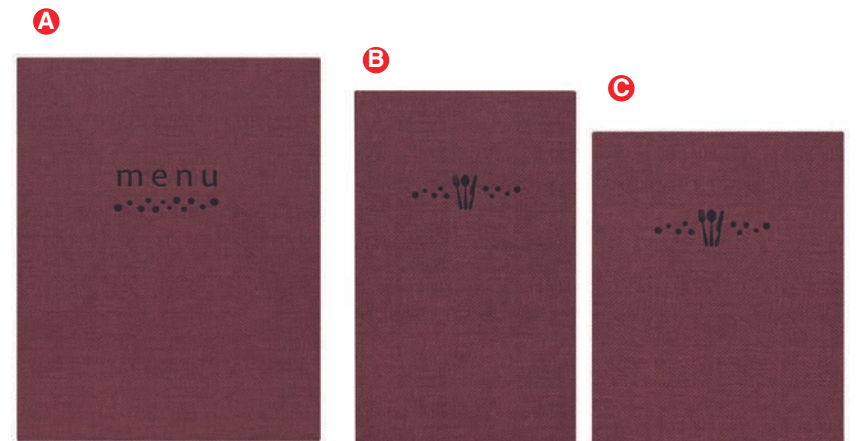

	Ref	€	cm	Fundas	Pack
<b>A</b>	28251	25,30	25x32 (A4)	3	4
<b>B</b>	28252	21,20	18x28	3	4
<b>C</b>	28253	20,40	19,5x23,5 (A5)	3	4

**Atornillado interior permite añadir o cambiar hojas o fundas según necesidad del cliente**  
Screwed interior to include pages or covers, according to the user's needs



## Peter

**New**



**Fabricado en Simil - Piel  
Termosellado en color Negro**

Fabriqué en cuir Simili - Cuir  
Thermoscage en couleur Noir

Hergestellt aus Lederimitat  
Die Heißprägung ist in den Farben schwarz

Manufactured in imitation leather  
Heat stamping in Black

Fabricado em Símil - Pele  
Termoselagem disponível nas cores Negro

**Porta menú**

Porte-menu  
Speisekartenmappe  
Menu cover  
Porta menu

	Ref	€	cm	Fundas	Pack
<b>A</b>	28261	31,20	25,5x32 (A4)	3	4
<b>B</b>	28262	27,30	18x28	3	4
<b>C</b>	28263	26,50	19,5x23,5 (A5)	3	4

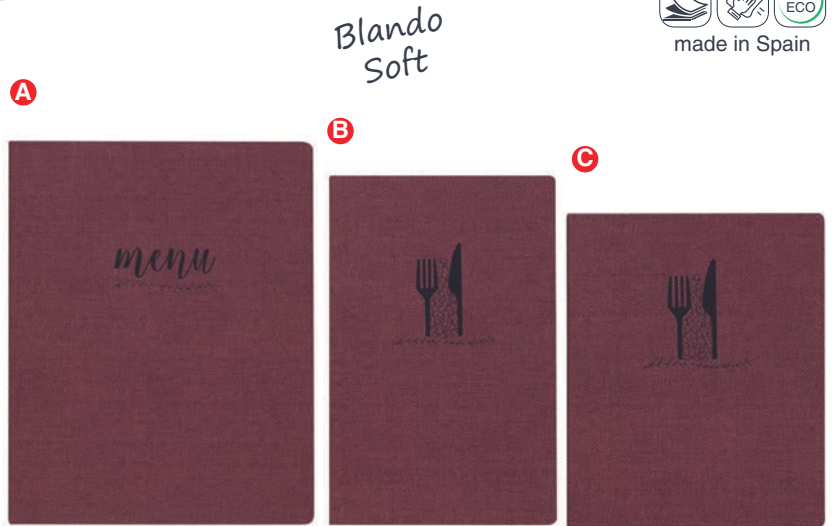

**Atornillado interior permite añadir o cambiar hojas o fundas según necesidad del cliente**  
Screwed interior to include pages or covers, according to the user's needs

## Andy

**New**



**Fabricado en Simil - Piel  
Termosellado en color Negro**

Fabriqué en cuir Simili - Cuir  
Thermoscage en couleur Noir

Hergestellt aus Lederimitat  
Die Heißprägung ist in den Farben schwarz

Manufactured in imitation leather  
Heat stamping in Black

Fabricado em Símil - Pele  
Termoselagem disponível nas cores Negro

**Porta menú**

Porte-menu  
Speisekartenmappe  
Menu cover  
Porta menu

	Ref	€	cm	Fundas	Pack
<b>A</b>	28271	22,00	23x32 (A4)	4	4
<b>B</b>	28272	17,60	15,5x28	4	4
<b>C</b>	28273	16,70	17x24 (A5)	4	4

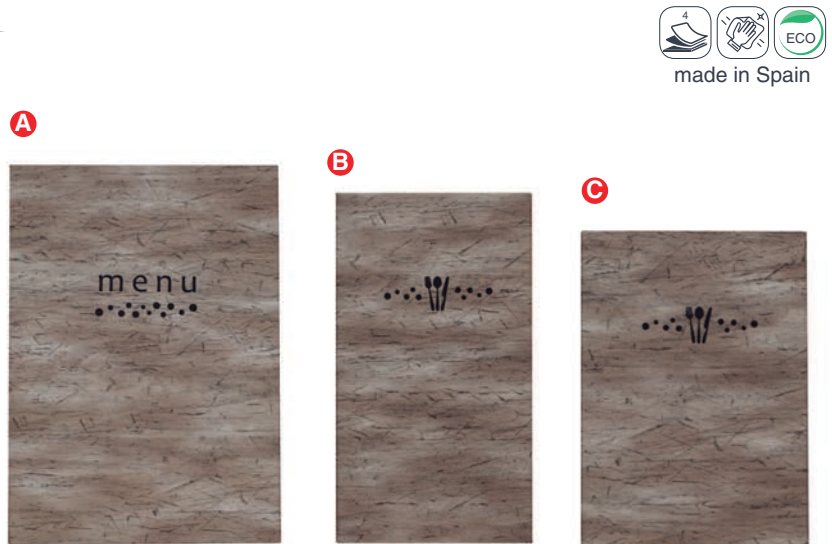

**Fundas fijas de PVC en piel de naranja. Altamente resistentes**  
Highly resistant, fixed frosted PVC covers

## Paolo

**New**



**Fabricado en Simil - Piel  
Termosellado en color Negro**

Fabriqué en cuir Simili - Cuir  
Thermoscage en couleur Noir

Hergestellt aus Lederimitat  
Die Heißprägung ist in den Farben schwarz

Manufactured in imitation leather  
Heat stamping in Black

Fabricado em Símil - Pele  
Termoselagem disponível nas cores Negro

**Porta menú**

Porte-menu  
Speisekartenmappe  
Menu cover  
Porta menu

	Ref	€	cm	Fundas	Pack
<b>A</b>	28281	31,90	25,5x32 (A4)	3	4
<b>B</b>	28282	27,80	18x28	3	4
<b>C</b>	28283	27,00	19,5x23,5 (A5)	3	4



**Atornillado interior permite añadir o cambiar hojas o fundas según necesidad del cliente**  
Screwed interior to include pages or covers, according to the user's needs

## Andrea

**New**



**Fabricado en Simil - Piel  
Termosellado en color Oro**

Fabriqué en cuir Simili - Cuir  
Thermoscage en couleur Or

Hergestellt aus Lederimitat  
Die Heißprägung ist in den Farben golden

Manufactured in imitation leather  
Heat stamping in Gold

Fabricado em Símil - Pele  
Termoselagem disponível nas cores Ouro

**Porta menú**

Porte-menu  
Speisekartenmappe  
Menu cover  
Porta menu

	Ref	€	cm	Fundas	Pack
<b>A</b>	28291	22,00	23x32 (A4)	4	4
<b>B</b>	28292	17,60	15,5x28	4	4
<b>C</b>	28293	16,70	17x24 (A5)	4	4

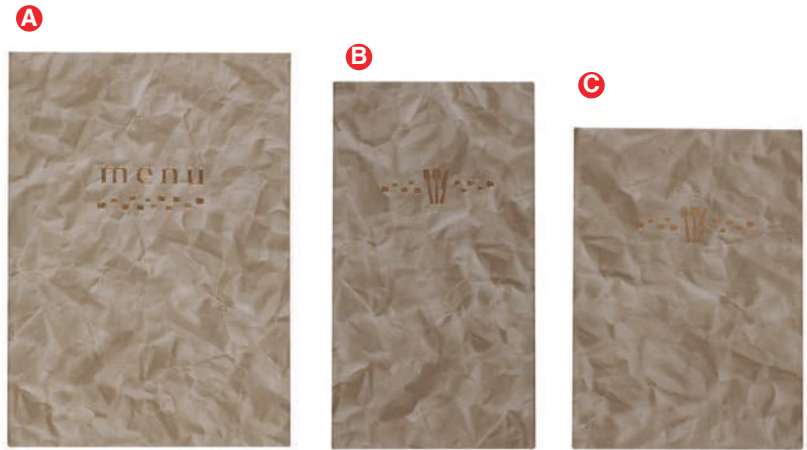

**Fundas fijas de PVC en piel de naranja. Altamente resistentes**  
Highly resistant, fixed frosted PVC covers

## Antoine

**New**



**Fabricado en Simil - Piel  
Termosellado en color Oro**

Fabriqué en cuir Simili - Cuir  
Thermoscage en couleur Or

Hergestellt aus Lederimitat  
Die Heißprägung ist in den Farben golden

Manufactured in imitation leather  
Heat stamping in Gold

Fabricado em Símil - Pele  
Termoselagem disponível nas cores Ouro

**Porta menú**

Porte-menu  
Speisekartenmappe  
Menu cover  
Porta menu

	Ref	€	cm	Fundas	Pack
<b>A</b>	28301	31,90	25,5x32 (A4)	3	4
<b>B</b>	28302	27,80	18x28	3	4
<b>C</b>	28303	27,00	19,5x23,5 (A5)	3	4



**Atornillado interior permite añadir o cambiar hojas o fundas según necesidad del cliente**  
Screwed interior to include pages or covers, according to the user's needs

## Leo



**Fabricado en Simil - Piel  
Termosellado en color Crema**

Fabriqué en cuir Simili - Cuir  
Thermoscage en couleur Crème

Hergestellt aus Lederimitat  
Die Heißprägung ist in den Farben creme-farben

Manufactured in imitation leather  
Heat stamping in Cream

Fabricado em Símil - Pele  
Termoselagem disponível nas cores Creme

**Porta menú**

Porte-menu  
Speisekartenmappe  
Menu cover  
Porta menu

Ref	€	cm	Solapas	Pack
28151	24,90	23x32 (A4)	3	4

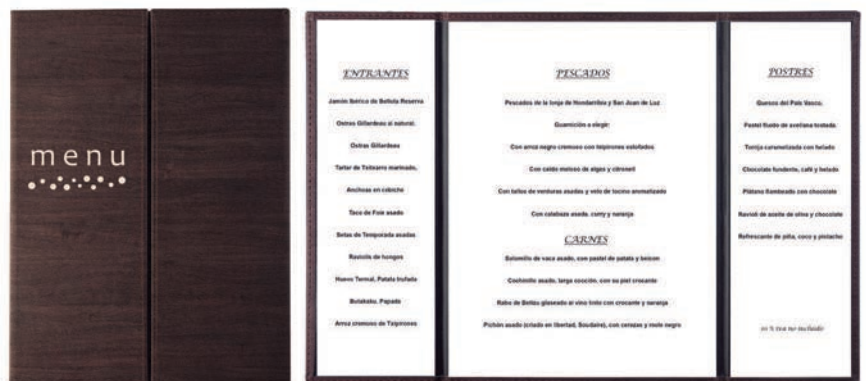

**3 solapas transparentes en Renoglass 0,40 mm**  
3 transparent flaps in Renoglass 0.40 mm





## Goya



made in Spain



**Fabricado en Simil - Piel  
Termosellado en color Negro**

Fabriqué en cuir Simili - Cuir  
Thermoscage en couleur Noir

Hergestellt aus Lederimitat  
Die Heißprägung ist in den Farben schwarz

Manufactured in imitation leather  
Heat stamping in Black

Fabricado em Simil - Pele  
Termoselagem disponível nas cores Negro



3 solapas transparentes en Renoglass 0,40 mm  
3 transparent flaps in Renoglass 0.40 mm

**Porta menú**

Porte-menu  
Speisekartenmappe  
Menu cover  
Porta menu

Ref	€	cm	Solapas	Pack
28161	24,90	23x32 (A4)	3	4

## Tiziano



made in Spain



**Fabricado en Simil - Piel  
Termosellado en color Crema**

Fabriqué en cuir Simili - Cuir  
Thermoscage en couleur Crème

Hergestellt aus Lederimitat  
Die Heißprägung ist in den Farben cremefarben

Manufactured in imitation leather  
Heat stamping in Cream

Fabricado em Simil - Pele  
Termoselagem disponível nas cores Creme



3 solapas transparentes en Renoglass 0,40 mm  
3 transparent flaps in Renoglass 0.40 mm

**Porta menú**

Porte-menu  
Speisekartenmappe  
Menu cover  
Porta menu

Ref	€	cm	Solapas	Pack
28172	22,80	17x24 (A5)	3	4

## Marcel



made in Spain



**Fabricado en Simil - Piel  
Termosellado en color Negro**

Fabriqué en cuir Simili - Cuir  
Thermoscage en couleur Noir

Hergestellt aus Lederimitat  
Die Heißprägung ist in den Farben schwarz

Manufactured in imitation leather  
Heat stamping in Black

Fabricado em Simil - Pele  
Termoselagem disponível nas cores Negro



3 solapas transparentes en Renoglass 0,40 mm  
3 transparent flaps in Renoglass 0.40 mm

**Porta menú**

Porte-menu  
Speisekartenmappe  
Menu cover  
Porta menu

Ref	€	cm	Solapas	Pack
28182	22,80	17x24 (A5)	3	4



## Max

**New**



**Fabricado en Telflex**  
 Fabriqué en cuir Telflex  
 Hergestellt aus Telflex  
 Manufactured in Telflex  
 Fabricado em Telflex



**Porta menú**

Porte-menu  
 Speisekartenmappe  
 Menu cover  
 Porta menu

**Con pinza metálica de color plata que sujeta la hoja del menú**  
 With a silver-coloured metal clip that holds the menu in place

Ref	€	cm	Pack
28311	11,60	23,5x33,5 (A4)	4

## Claudio

**New**



**Fabricado en Simil - Piel**  
 Fabriqué en cuir Simili - Cuir  
 Hergestellt aus Lederimitat  
 Manufactured in imitation leather  
 Fabricado em Símil - Pele



**Porta menú**

Porte-menu  
 Speisekartenmappe  
 Menu cover  
 Porta menu

**Con pinza metálica de color plata que sujeta la hoja del menú**  
 With a silver-coloured metal clip that holds the menu in place

Ref	€	cm	Pack
28321	14,40	23,5x33,5 (A4)	4









CORTE  
•  
CUTTING

Corte  
*Cutting*



## Professional

**Cortador de bolas**

Cuillère à pommes  
Kugelausstecher  
Fruit baller  
Cortador bolas

Ref	€	Ø (mm)	Pack
60366	6,20	15	12
60367	6,30	20	12
60368	6,30	25	12
60369	6,00	30	12

**Cortador de bolas oval rizado**

Cuillère à pommes forme oval canelée  
Kugelausstecher Oval Gerippt formchen  
Fruit baller oval fluted  
Cortador bolas oval frizado

Ref	€	mm	Pack
60372	6,90	20x32,5	12

**Pelapatatas "Y"**

Eplucheur "Y"  
"Y" Schäler  
"Y" Peeler  
Pela-batatas "Y"

Ref	€	mm	Pack	
60377	7,30	55x55	12	Liso - Plane
60378	8,20	55x55	12	Dentado - Serrated

**Pelapatatas "P"**

Eplucheur "P"  
"P" Schäler  
"P" Peeler  
Pela-batatas "P"

Ref	€	mm	Pack
60380	5,40	16x55	12

**Pelador espárragos**

Éplucheur à asperges  
Spargelschäler  
Asparagus peeler  
Descascador de espárgos

Ref	€	mm	Pack
60381	8,00	20x110	12

**Pelador cuchilla fija**

Éplucheur lame fixe  
Schäler Messerfix  
Fix blade peeler  
Pela-batatas lâmina fixa

Ref	€	mm	Pack
60398	4,10	15x75	12

**Cuchillo vaciador**

Couteau pour fruits  
Frucht messer  
Fruit knife  
Faca para fruta

Ref	€	mm	Pack
60399	4,90	20x105	12



## Luxe

**Cuchillo para queso**

Couteaux à fromage  
Käsemesser  
Cheese knife kitchen tool  
Faca para queijo

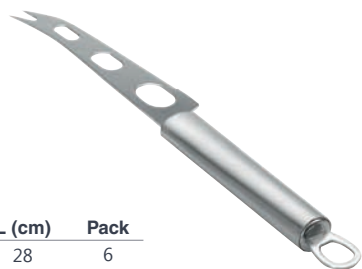

Ref	€	cm	L (cm)	Pack
62675	9,10	14	28	6

**Espátula lisa**

Spatule lisse  
Backschaufel  
Spatula  
Espátula

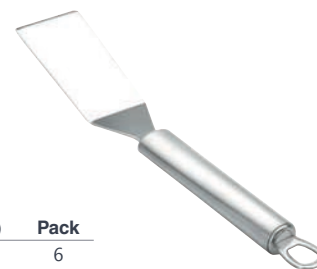

Ref	€	cm	L (cm)	Pack
62676	7,60	4,3x11	25	6

**Descorazonador**

Vide-pommes  
Apfelentkerner  
Aple corer  
Descaraçador



Ref	€	cm	L (cm)	Pack
62686	7,90	2x2	20	12

**Cortador de bolas**

Cuillère à pommes  
Kugelausstecher  
Fruit baller  
Cortador de bolas



Ref	€	cm	L (cm)	Pack
62683	7,20	3x1	19	12

**Pelapatatas "Y"**

Eplucheur "Y"  
"Y" Schäler  
"Y" Peeler  
Descascador de batatas "Y"



Ref	€	cm	L (cm)	Pack
62687	9,30	5x2	18	12

**Pelapatatas "P"**

Eplucheur "P"  
"P" Schäler  
"P" Peeler  
Descascador de batatas "P"



Ref	€	cm	L (cm)	Pack
62688	8,40	2x1	20	12

**Pala pastel serrada**

Palette à gâteau dentellé  
Kuchenschaufel  
Serrated cake shovel  
Espátula de bolos c/serrilha



Ref	€	cm	L (cm)	Pack
62673	10,10	5,5x13	26	6

**Abre ostras LUXE Inox 18/10**

Couteau à huîtres LUXE en Inox 18/10  
Austermesser, LUXE, Rostfrei 18/10  
LUXE oyster opener st. steel 18/10  
Aberto-ostras Luxe Inóx 18/10



Ref	€	L (cm)	Pack
62684	10,10	20	1

**Prensa ajos**

Presse-pail  
Knoblauchpresse  
Garlic press  
Esmaga-alhos

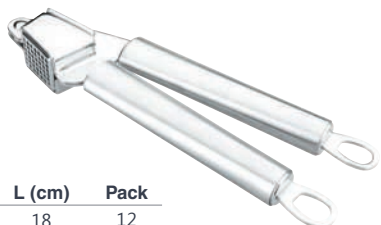

Ref	€	cm	L (cm)	Pack
62685	19,30	3x5	18	12

**Abrelatas**

Ouvre-boîte  
Desenöffner  
Can opener  
Abre-latas



	Ref	€	cm	L (cm)	Pack
A	62689	21,40	5x4	20	12
B	63038	17,90	5x4	17	6

## Peladores



**Pelador tomate dentado P**  
Épluche tomates à dents P  
Tomatenschäler, gezackt, P  
P Serrated tomato peeler  
Pelador tomate dentado P

Ref	€	L (cm)	Pack
60351	11,70	19,5	6



**Pelador tomate dentado T**  
Épluche tomates à dents T  
Tomatenschäler, gezackt, T  
T Serrated tomato peeler  
Pelador tomate dentado T

Ref	€	L (cm)	Pack
60352	11,50	17,5	6



**Descorazonador**  
Vide tomates  
Tomatenentkerner  
Tomato core remover  
Descoraçador

Ref	€	L (cm)	Pack
60353	8,60	16,5	6



**Cuchillo dentado**  
Couteau à dents à tomates  
Tomatenmesser, gezahnt  
Serrated tomato knife  
Faca dentada

Ref	€	L (cm)	Pack
60354	8,50	22	6

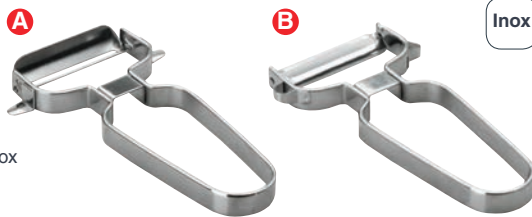

**Pelador Inox**  
Éplucheuse en Inox  
Schäler, Rostfrei  
St. steel peeler  
Descascador Inóx

Ref	€	cm	Pack
<b>A</b> 60346	9,50	5,5x12	24 Liso - Plane
<b>B</b> 60347	9,50	5,5x12	24 Dentado - Serrated

**Pelador de espárragos liso**  
Éplucheuse à asperges plate  
Normalen Spargelschäler  
Asparagus peeler plain blade  
Descascador de espárragos liso

Ref	€	L (cm)	Pack
60545	7,40	12,5	6



**Pelador liso P**  
Éplucheuse plate P  
Normalen Schäler P  
P peeler plain blade  
Descascador liso P

Ref	€	L (cm)	Pack
60546	9,60	17,0	6



**Pelador liso Y**  
Éplucheuse plate Y  
Normalen Schäler Y  
Y peeler plain blade  
Descascador liso Y

Ref	€	L (cm)	Pack
60547	8,70	12,5	6



**Pelador cerámico Y**  
Éplucheuse en céramique Y  
Y Schäler, Keramik  
Y ceramic peeler  
Descascador cerâmico Y

Ref	€	cm	Pack
60444	3,10	8,5x16,5	6



**Cuchilla cerámica y mango SOFT TOUCH**  
Preserva la oxidación de los alimentos  
Girando la cuchilla es apto para diestros y zurdos

Lame céramique et poignée SOFT TOUCH  
Préserve l'oxydation des aliments  
En faisant tourner la lame, il est compatible aussi bien pour les gauchers que pour les droitiers

Keramikklinge und Stiel SOFT TOUCH  
Schützt vor Oxidation der Lebensmittel  
Durch Wenden des Messers ist es für Rechts- und Linkshänder geeignet

Ceramic blade and SOFT TOUCH handle  
Preserves the oxidation of the food  
Turning the blade it is suitable for right- and left-handed individuals

Lâmina de cerâmica e cabo SOFT TOUCH  
Preserva a oxidação dos alimentos  
Girando a lâmina é apto para pessoas destros e canhotos





**Pelador "P" 3 cuchillas giratorias**  
Éplucheuse "P" 3 lames tournantes  
"P" schäler, 3 Schäler, drehnbar  
"P" type peeler 3 rotating blades  
Descascador "P" 3 lâminas giratórias

Ref	€	L (cm)	Pack
60388	17,90	20	6

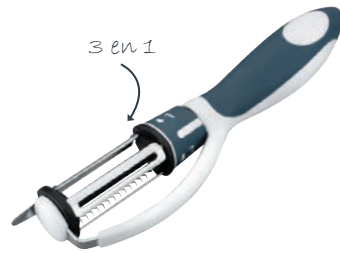

**Pelador "Y" 3 cuchillas giratorias**  
Éplucheuse "Y" 3 lames tournantes  
"Y" schäler, 3 Schäler, drehnbar  
"Y" type peeler 3 rotating blades  
Descascador "Y" 3 lâminas giratórias

Ref	€	L (cm)	Pack
60389	18,90	20	6



**Pelador aguacate**  
Coupe avocat  
Schäler avocados  
Avocado peeler  
Descascador abacate

Ref	€	cm	Pack
61355	6,90	24x24	12



**Laminador de aguacate**  
Éplucheuse avocats  
Schäler avocados  
Avocado slicer  
Descascador abacater

Ref	€	cm	L (cm)	Pack
61353	9,50	6,2	24	12



**Pelador de piña**  
Set coupe ananas  
Ananas-Schäler  
Pineapple peeler  
Pelador de ananas

Ref	€	Ø (cm)	Pack
60392	8,70	Ø10x23	4



**Juego cortador-pelador piña con base**  
Jeu couteau et éplucheur ananas  
Messer und Schäler set für ananas  
Set pineapple cutter-peeler with canister  
Jogo cortador e descascador de ananas

Ref	€	Ø (cm)	Pack
60393	19,00	9	12





## Cortadores

Tallarines de verduras 100% naturales  
 Tagliatelles de légumes 100% naturelles  
 100% natürliche Gemüsebandnudeln  
 100% natural vegetable noodles  
 Talharins de verduras 100% naturais

**New**



Corta frutas y verduras en forma de tallarines. Ideal para calabacín, zanahoria, nabo, patata, remolacha etc. Alimentación saludable y baja en hidratos de carbono  
 Se utiliza del mismo modo que un sacapuntas  
**Cuchillas de acero inoxidable**  
 Incluye un contenedor-empujador que sirve como protector para un agarre seguro y también como almacenamiento  
**Contenedor de almacenaje de 400 ml con tapa para transportarlo donde quieras**  
**Dispone de dos contenedores en la tapa y cubiertos como accesorios**  
**Apto para el lavavajillas**

Coupe les fruits et les légumes en forme de tagliatelles. Idéal pour les courgettes, carottes, navets, pommes de terre, betteraves, etc. Alimentation saine et faible en hydrates de carbone  
 S'utilise comme un taille-crayon  
 Lames en acier inoxydable  
 Comprend un conteneur pousseur qui sert de protection pour une utilisation sûre et pour le stockage des aliments  
 Conteneur de stockage de 400 ml avec couvercle pour le transporter partout  
 Contient deux récipients dans le couvercle et des couverts dans le conteneur  
 Apte pour le lave-vaisselle

Zum Gemüsebandnudeln Schneiden von Obst und Gemüse. Ideal für Zucchini, Karotten, Rüben, Kartoffeln, Rote Beete, usw. Gesunde Ernährung, arm an Kohlehydraten  
 Es wird in gleicher Weise wie ein Anspitzer verwendet  
 Messer aus rostfreiem Stahl  
 Verfügt über einen Behälter, der für die sichere Anwendung und Lagerung von Lebensmitteln als Saatgut als dient  
 Speicherbehälter mit 400 ml Volumen mit Deckel zum Transport  
 Enthält zwei Behälter im Deckel und Besteck im Behälter  
 Waschmaschinenfest

Slice fruit and vegetables into noodleshapes. Ideal for courgettes, carrots, turnips, potatoes, beetroot, etc. Healthy and low carbohydrate food  
 Works just like a pencil sharpener  
 Stainless steel blades  
 Includes a pusher container that serves as a protector for safe use and for storing food as seeds  
 400 ml storage container with lid for taking it wherever you want  
 Includes two containers in the lid and cutlery in the container  
 Dishwasher safe

Corta frutas e verduras em forma de talharins. Ideal para courgette, cenoura, nabo, batata, beterraba, etc. Alimentação saudável e baixa em hidratos de carbono  
 Utiliza-se como um afiador de lápis  
 Lâminas de aço inoxidável  
 Inclui um recipiente protetor que serve como protetor para uma utilização segura e para armazenamento de alimentos  
 Recipiente de armazenamento de 400 ml com tampa para o poder transportar para qualquer lugar  
 Inclui dois recipientes na tampa, e talheres no recipiente  
 Apto para máquinas de lavar louça

### Cortador en espiral manual

Coupe en spirale manuelle  
 Manueller Spiralschneider  
 Manual spiral cutter  
 Cortador em espiral manual

Ref	€	Ø (cm)	ml	Pack
60524	14,90	9x22	400	1



### Cortador en espiral dentado

Coupe en spirale dentée  
 Spiralschneider, gezähnt  
 Serrated spiral cutter  
 Cortador em espiral dentado



Ref	€	Ø Int. (cm)	Cuchilla L (cm)	Pack
60527	3,00	8	5,5	6



### Cortador en espiral liso

Coupe en spirale lisse  
 Spiralschneider, glatt  
 Plain spiral cutter  
 Cortador em espiral liso



Ref	€	Ø Int. (cm)	Cuchilla L (cm)	Pack
60528	3,00	8	5,5	6



**New**



### Cortador en espiral spaguetti

Coupe en spirale  
 RSpiralschneider  
 Spiral cutter  
 Cortador em espiral



Ref	€	Ø Int. (cm)	Cuchilla L (cm)	Pack
60529	2,90	8	5,5	6

### Corta verduras manual doble cuchilla Inox

Hachoir de légumes double manuel en Inox  
 Manual Doppelschneidig - Wiegemesser, Rostfrei  
 St. steel vegetables manual double blade chopper  
 Corta verduras manual duplo lâmina Inóx



Ref.	€	cm	Pack
60328	15,90	15x4	6
60365	13,00	17x2	6

**New****Cortador de verduras SAFECUT**

Couper de légumes  
Gemüseschneidmaschine  
Vegetables cutter  
Cortador de verdura

Ref	€	cm	Cuchilla	Pack
60298	35,20	26x13x29	3	1

Permite cortar de forma rápida y sin esfuerzo todo tipo de vegetales, hortalizas, quesos, chocolates, frutos secos, etc.

Alto rendimiento de trabajo, girar la manivela equivale a cortar 12 veces  
3 cuchillas intercambiables que permiten rallar y cortar todo tipo de alimentos:

**FINA:** Para rallar cáscara de limón, pan, chocolate, frutos secos, queso, manzana, etc.

**GRUESA:** Patatas, cebollas, zanahorias, repollo, calabacín, lechuga, fruta, pan, etc.

**RODAJAS:** Prepara patata en rodajas para asados, pepino, zanahoria, calabacín, etc.

Cuchillas de acero inoxidable de alta calidad resistentes al desgaste

Dispone de una ventosa que proporciona una gran estabilidad en su uso

Se desmonta fácilmente para lavar

Las piezas desmontables son aptas para el lavavajillas (excepto la base), aunque se aconseja lavar a mano las cuchillas

Il permet de couper de manière rapide et sans effort tout type de légumes, fromage, chocolat, fruits secs, etc.

Rendement élevé, tournez la manivelle est égale à couper 12 fois

3 lames interchangeable qui permettent de râper et couper tout type d'aliments :

**FINE :** Pour râper la zeste de citron, pain, fruits secs, fromage, pomme, etc.

**GROSSE :** Pommes de terre, oignons, carottes, chou, courgette, laitue, fruit, pain etc.

**TRANCHES :** Prépare les pommes de terre pour les faire griller, concombre, carotte, courgette, etc.

Lames en acier inoxydable de haute qualité, résistantes à l'usure

Elle dispose d'une ventouse qui fournit une grande stabilité pendant son utilisation

Démontage facile pour le nettoyage

Les pièces démontables sont conçues pour être nettoyées dans le lave-vaisselle, bien qu'il soit conseillé de laver les lames à la main

Schneidet mühelos alle Arten von Feld- und Gartengemüse, Käse, Schokolade, Trockenobst usw.

Eine Kurbeldrehung entspricht zwölf Schnitten

3 verschiedene Aufsätze zum Scheiden und Reiben aller möglichen Lebensmittel:

**FEIN:** Für Zitronenschalen, Brot, Schokolade, Trockenobst, Käse, Äpfel usw.

**GROB:** Zwiebeln, Karotten, Kohl, Zucchini, Salat, Obst, Brot usw.

**SCHIEBEN:** Kartoffelscheiben für Pfannengerichte, Gurken, Karotten, Kürbis usw.

Messer aus rostfreiem Stahl mit lang anhaltendem Schliiff

Saugfläche sorgt für festen Halt bei der Arbeit

Einzelteile einfach zu reinigen

Einzelteile sind spülmaschinengeeignet. Messer am besten von Hand reinigen

You can cut all kinds of vegetables, garden produce, cheese, chocolate or nuts quickly and easily

You can save a lot of work because one turn of the crank is the same as cutting 12 times

There are 3 interchangeable blades that can be used to cut or grate all kinds of food

**FINE:** For grating lemon peels, bread, chocolate, nuts, cheese, apples, etc.

**COARSE:** Potatoes, onions, carrots, cabbage, courgette, lettuce, fruit, bread, etc.

**SLICES:** Slice potatoes for roasts, cucumbers, carrots, courgette, etc.

It has high quality wear resistant stainless steel blades

It has a suction cup that provides great stability during use

It's easy to take apart and clean

The removable pieces are dishwasher safe, although we recommend washing the blades by hand

Permite cortar de forma rápida e sem esforço todo o tipo de vegetais, hortaliças, queijos, chocolate, frutos secos, etc.

Elevado rendimento de trabalho: girar a manivela equivale a cortar 12 vezes

3 lâminas intercambiáveis para ralar e cortar todo o tipo de alimentos:

**FINA:** Para ralar casca de limão, pão, chocolate, frutos secos, queijo, maçã, etc.

**GROSSA:** Batata, cebola, cenoura, repolho, curgete, alface, fruta, pão, etc.

**RODELAS:** Corta batatas em rodajas para assados, pepino, cenoura, curgete, etc.

Lâminas em aço inoxidável de grande qualidade, resistentes ao desgaste

Equipado com uma ventosa que lhe proporciona uma grande estabilidade

Fácil de desmontar e de lavar

As peças desmontáveis são aptas para a máquina de lavar, embora seja recomendado lavar à mão as lâminas



TPR  
Plastic

PP  
Polystyrene

**Descorazonador manual**

Vide-pommes manuel  
Apfelenkerner  
Manual apple corer  
Descorçador manual



Ref	€	Pack
60350	6,20	1

**Corta melones-sandias**

Trancheur à melons  
Schneiden von Melanen-Wassermelone  
Melon cutter-watermelon  
Corte os melões-melancia

Ref	€	Ø (cm)	Pack
60397	16,50	25,0	12



Zinc Alloy

**Cortahuevos doble uso DUAL**  
Coupe-oeuf 2 utilisations DUAL  
Eirschneider, 2-wedig, DUAL  
DUAL 2 way egg cutter  
Corta-ovos duplo uso DUAL

Ref	€	Ø (cm)	Pack
68305	16,40	7	12



**Cortahuevos**  
Coupe-oeuf en inox  
Eirschneider, Rostfrei  
St. steel egg slicer  
Corta-ovos

Ref	€	Ø (cm)	Pack
68306	14,70	10	12



**Cortahuevos doble uso**  
Coupe-oeuf 2 utilisations  
Eirschneider, 2-wedig  
2 way egg cutter  
Corta-ovos duplo uso

Ref	€	cm	Pack
68307	28,50	15x10x3,7	12



**Cortahuevos cuchilla**  
Coupe-fromage avec lame  
Kräsemesse, mit Klinge  
Cheese cutter with blade  
Corta-queijos lâmina

Ref	€	cm	Pack
60005	23,00	27,5x21x3	1



**Cortador de queso fresco**  
Fromage coupe fil  
Kräse Drahtschneider  
Cheese wire cutter  
Corta-queijos

Ref	€	cm	Pack
60004	3,80	17	1
60009	4,20	21	1



**Peine cortacarne Inox**  
Peigne pour coupe viande en inox  
Fleischzange, Rostfrei  
Stainless steel meat tong  
Pinça/pente corta-carne

Ref	€	cm	Pack
60336	15,70	11x30x6,5	6



**Cortabacalao**  
Coupe pain  
Brotmesser  
Bread knife  
Corta-bacalhau

Ref.	€	cm	Pack
60000	188,90	11x58,5x8	1



**Cortador Juliana 2,8 mm**  
Julienne de coupe 2,8 mm  
Julienne-Schneider 2,8 mm  
Julienne cutter 2,8 mm  
Cortador juliana 2,8 mm

Ref	€	h (cm)	Pack
60358	4,90	18	12



**Laminador de trufa Inox**  
Coupe-Truffles en Inox  
Truffelschneider, Rostfrei  
St. steel truffe-slicer  
Laminador trufa Inóx

Ref	€	h (cm)	Pack
61351	11,60	18	12



**Rallador-laminador de queso**  
Râpe et lamineur pour le fromage  
Reiber-Walwerk fuer Kaese  
Cheese grater-cutter  
Ralador e laminador para queijo

Ref	€	L (cm)	Pack
61352	13,00	23,50	6

**Cortapizza con cuchilla final**  
Roulette Pizza avec lame finale  
Pizzaschneider mit messer final  
Pizza cutter with final blade  
Corta-pizza com lâmina final



Ref	€	Ø (cm)	Pack
67028	10,00	10	12



**Cortapizza**  
Roulette pizza  
Pizzaschneider  
Pizza cutter  
Corta-Pizza Inóx 18/10

Ref	€	Ø (cm)	Pack
67027	4,70	8	12



**Cortapizza**  
Roulette pizza  
Pizzaschneider  
Pizza cutter  
Corta-Pizza Inóx 18/10

Ref	€	Ø (cm)	Pack
60429	4,00	10	12



**Cortapizza**  
Roulette pizza  
Pizzaschneider  
Pizza cutter  
Corta-Pizza Inóx 18/10

Ref	€	Ø (cm)	Pack
67004	14,20	10	6

## Ralladores

Inox

**Rallador plano 3 usos**  
Râpe plat  
Reibe 3 Nützlichkeit  
Grater 3 uses  
Ralador plano 3 usos



Ref	€	cm	Pack
60301	6,20	25,5x11	12

**Rallador plano paso grueso**  
Râpe plat  
Reibe, grob  
Grater big hole  
Ralador plano passo grosso



Ref	€	cm	Pack
60302	6,20	25,5x11	12

**Rallador plano paso fino**  
Râpe plat  
Reibe, fein  
Grater small hole  
Ralador plano passo fino



Ref	€	cm	Pack
60303	6,20	25,5x11	12

**Rallador de limón Inox 18/10**  
Râpe muscade inox 18/10  
Zitronenreibe, Edelstahl 18/10  
Grater semi-circular s. steel 18/10  
Ralador de limão Inóx 18/10



Ref	€	cm	Pack
67008	4,90	23x6	12





Extremadamente afilado  
Extremely sharp

**Rallador especias Mini**

Râpe à épices Mini  
Mini-Reibe Gewürze  
Mini spices grater  
Ralador especiarias Mini



Ref	€	cm	h (cm)	Pack
67032	2,80	11x7	1	6



Extremadamente afilado  
Extremely sharp

**Rallador especias**

Râpe à épices  
Reibe Gewürze  
Spices grater  
Ralador especiarias



Ref	€	cm	h (cm)	Pack
67033	3,90	14x7	1	6



No absorben sustancias de los alimentos  
It does not adsorb food stuffs



**New**

**Rallador especias Mini**

Râpe à épices Mini  
Mini-Reibe Gewürze  
Mini spices grater  
Ralador especiarias Mini



Ref	€	cm	h (cm)	Pack
67182	3,50	14,5x8	1	6



No absorben sustancias de los alimentos  
It does not adsorb food stuffs



**New**

**Rallador especias**

Râpe à épices  
Reibe Gewürze  
Spices grater  
Ralador especiarias



Ref	€	cm	h (cm)	Pack
67183	3,50	11x7	1	6



**Rallador nuez moscada Mini**

Râpe à noix de muscade Mini  
Mini-Musket Reibe  
Mini nutmeg grater  
Ralador noz-moscada Mini

Ref	€	h (cm)	Pack
67009	1,70	14	12



**Rallador nuez moscada**

Râpe à muscade en Inox  
Musket Reibe  
Nutmeg grater  
Ralador noz-moscada



Ref	€	cm	h (cm)	Pack
67031	8,30	4,5x3	15	12

3 en 1

Rallar • Espolvorear • Guardar  
Râper • Réduire en poudre • Conserver  
Grate • Sprinkle • Store



**Rallador STICK**

Râpe  
Zerkleinerer  
Grater  
Ralador

Ref	€	L (cm)	Pack
61357	9,40	17,0	6



3 en 1

Rallar • Espolvorear • Guardar  
Râper • Réduire en poudre • Conserver  
Grate • Sprinkle • Store



**Rallador KONTTI**

Râpe  
Zerkleinerer  
Grater  
Ralador

Ref	€	cm	Pack
61358	11,80	14x8x13	6



2 en 1

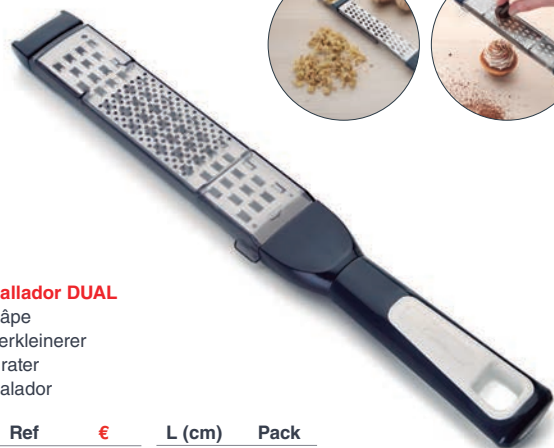

**Rallador DUAL**

Râpe  
Zerkleinerer  
Grater  
Ralador

Ref	€	L (cm)	Pack
61360	8,10	31,0	6

4 en 1

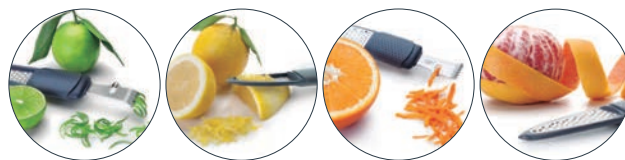

**Rallador decorador multiusos**

Râpe pour décoration multi-usages  
Mehrzweckreibe zum Verzieren  
Multipurpose zester  
Ralador decorador multiusos

Ref	€	L (cm)	Pack
63911	9,20	18,0	6

**Rallador Inox**

Râpe en Inox  
Zerkleinerer, Rostfrei  
St. steel grater  
Ralador inóx

	Ref	€	Pack	
<b>A</b>	61341	12,40	6	Extra fino · Extra fin
<b>B</b>	61342	12,40	6	Fino · Thin
<b>C</b>	61343	12,40	6	Grueso · Thick
<b>D</b>	61344	12,40	6	Juliana · Julienne



**Rallador largo Inox**

Râpe longue en Inox  
Zerkleinerer, lang, Rostfrei  
St. steel lengthways grater  
Ralador comprimo Inóx

	Ref	€	Pack	
<b>A</b>	61346	12,30	6	Fino · Thin
<b>B</b>	61347	12,50	6	Medio · Medium
<b>C</b>	61348	12,40	6	Grueso · Thick
<b>D</b>	61349	12,40	6	Fino+Medio · Thin+Medium

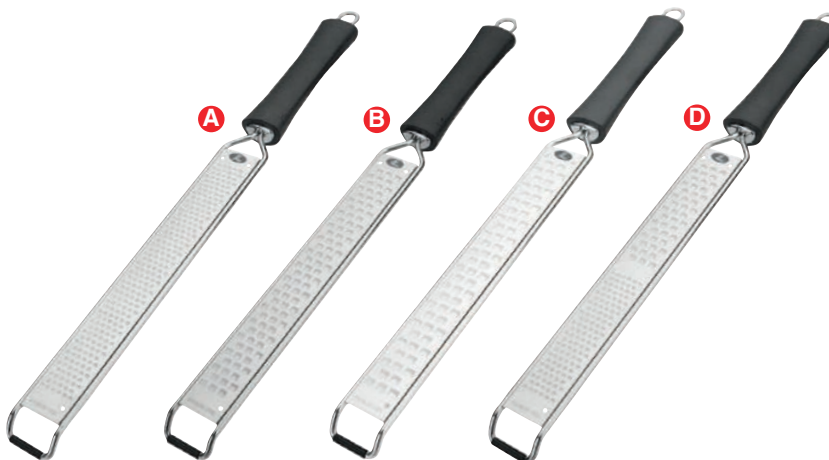

**Rallador Inox 18/10**

Râpe en Inox 18/10  
Reibe aus Rostfrei 18/10  
St. steel 18/10 grater  
Ralador Inóx 18/10



Ref	€	h (cm)	Pack	
60305	5,60	23	12	4 caras · 4 faces
60307	13,10	24	6	6 caras · 6 faces

**Rallador LUXE**

Râpe LUXE  
Reibe, LUXE  
LUXE grater  
Ralador LUXE



Ref	€	h (cm)	Pack	
61354	21,90	23,5	6	4 caras · 4 faces
61356	21,90	23,0	6	6 caras · 6 faces

## Mandolinas

**Mandolinas robusta y funcional**

**Gira la rueda para seleccionar el espesor de corte o el tipo de juliana que desees obtener**  
**Sus cuchillas extremadamente afiladas proporcionan un corte homogéneo y preciso**  
**Base antideslizante y protector de dedos que evita el contacto con las cuchillas durante su uso**

**Las cuchillas se extraen fácilmente para su lavado**

**Pies plegables con base de silicona para mejorar la estabilidad**

**Ocupa poco espacio, se pliega sobre sí misma**

Mandolines robuste et fonctionnelle

Faites tourner la roue pour sélectionner l'épaisseur de la coupe ou le type de julienne que vous souhaitez obtenir

Ses lames extrêmement aiguës confèrent une coupe homogène et précise

Base antidérapante et protection pour les doigts qui évite le contact avec les lames pendant son utilisation

Les lames se retirent facilement pour leur nettoyage

Pieds réglables avec base en silicone pour améliorer la stabilité

Prend peu de place, se plie sur elle-même

Robuste und praktische Multifunktionsreibe

Schnittstärke oder Juliennart nach Wunsch am Drehknopf einstellbar

Extrem scharfe Klingen sorgen für einheitliches und genaues Schneiden

Rutschfeste Standbeine und Fingerschutz verhindern Kontakt mit Klingen bei Gebrauch

Zum säubern leicht entnehmbare Klingen

Einklappbare Standbeine mit Silikonuntersatz für verbesserte Standfestigkeit

Platzsparend zusammenklappbar

Robust and functional mandolines slicer

Turn the wheel to select the thickness of the slice or the type of julienne cut you wish to make

Its extremely sharp blades make even and accurate cuts

Non-slip base and finger guard to prevent coming in contact with the blades during usage

The blades can be easily removed for washing

Folding legs with a silicone base to improve stability

Takes up very little space and folds up over itself

Mandolinas robusta e funcional

Gira a roda para selecionar a espessura de corte ou o tipo de juliana pretendido

As suas lâminas extremamente afiadas proporcionam um corte homogéneo e preciso

Base antideslizante e protetor de dedos, que evita o contacto com as lâminas durante o uso

As lâminas extraem-se facilmente para a sua lavagem

Patas dobráveis, com base de silicone para maior estabilidade

Ocupa pouco espaço, dobrando-se sobre si mesma

**New****Mandolina SMART**

Mandoline

Mandoline

Mandoline

Mandoline

Mandoline

Ref	€	Abierta (cm)	Pack
60447	56,30	38x17,5x15,5	1

**Mandolina plástico 5 cuchillas y exprimidor**

Mandoline multi-râpes et presse-fruits

Multifunktionsreibe und Zitruspresse

Kitchen grater with 5 blades and squeezer

Mandolina plástico 5 lâminas e espremedor

Ref	€	cm	Pack
60331	24,90	14,5x34,5	1

**Mandolina corte en V + 5 Cuchillas + Exprimidor**

Mandoline avec lames en "V" + 5 Lames + Presse-fruits

"V" Mandoline + 5 Messer + Zitruspresse

"V" Mandoline + 5 Blades + squeezer

Mandolina "V" + 5 Lâminas + espremedor

Ref	€	cm	Pack
60356	30,10	13x33,5	1

*Sistema doble filo: Corta dos veces más rápido*

*Système à double biseau: coupe deux fois plus rapidement*

*Zweischneidiges System: Schneidet doppelt so schnell*

*Double-blade system: Cuts twice as fast*

*Sistema de duplo fio: Corta duas vezes mais rápido*

**Mandolina corte doble**

Mandoline double coupé

Mandoline double schneider

Dual slice mandoline

Mandolina duplo corte

Ref	€	cm	Pack
60441	17,00	30,5x12x4	6



**Mandolina Inox LUXE con 5 cuchillas**

Mandoline en inox LUXE  
 Reibe, edelstahl rostfrei LUXE  
 St. Steel mandoline  
 Mandolina Inóx Luxe com 5 lâminas

Ref	€	cm	Pack
60332	91,90	14x42	1



**Cuchillas giratorias**  
 Rotating blades

**Mandolina Inox con protector**

Mandoline en Inoxydable avec protecteur  
 Mandoline, Edelstahl 18/10, mit Restehalter  
 St. steel mandoline slicer w/protector  
 Mandolina inoxidável com protector

Ref	€	cm	Pack
60357	100,50	12,5x50	1



## Máquinas de corte

### Aumenta la productividad disminuyendo el tiempo de trabajo frente a sistemas convencionales

Gama de Corte Profesional con 6 modelos de corte manual. Con un diseño robusto y ergonómico, gracias a sus cuchillas de acero inoxidable (resistentes a la corrosión), aseguran un corte uniforme y de gran calidad. Ideales para cualquier cocina Industrial, su fácil manejo permite obtener un óptimo rendimiento con el mínimo esfuerzo.

### Augmente la productivité et diminue le temps de travail par rapport aux systèmes conventionnels

Gamme de Coupe Professionnelle avec 6 modèles de coupe manuelle. Avec une conception robuste et ergonomique, notamment grâce aux lames en acier inoxydable (résistantes à la corrosion), ils garantissent une coupe uniforme et de grande qualité. Ils s'adaptent parfaitement aux différents types de cuisine industrielle et la facilité de manipulation permet d'obtenir un rendement optimal avec le moindre effort.

### Erhöht im Vergleich zu konventionellen Systemen die Produktivität bei geringerer Arbeitszeit

Profi-Allesschneidern mit 6 Modelle im Bereich Handschneidemaschinen. Robustes und ergonomisches Design; seine Edelstahlklingen (rostresistent) garantieren einen gleichmäßigen, präzisen Schnitt. Ideal für jede Industrieküche, da die einfache Bedienung optimale Leistung bei minimalem Aufwand erlaubt.

### Increases productivity by reducing working time when compared to conventional systems

Range of Professional Cutting Utensils with 6 new manual cutting models. With a robust and ergonomic design, its stainless steel (corrosion resistant) blades ensure a smooth and high quality cut. Ideal for any Industrial kitchen, their ease of use enables optimum performance with minimum effort.

### Aumenta a produtividade reduzindo o tempo de trabalho em comparação com os sistemas convencionais

Gama de Corte Profissional com 6 novos modelos de corte manual. Com um design robusto e ergonómico, graças às suas lâminas de aço inoxidável (resistentes à corrosão), asseguram um corte uniforme e de grande qualidade. Ideais para qualquer cozinha industrial, o seu fácil manejo permite obter um ótimo rendimento com o mínimo esforço.



#### **Máquina corta tomates**

Machine pour couper tomates  
Maschine Schneidt Tomaten  
Tomato cutter machine  
Máquina cortador tomate

Ref	€	Espesor (mm) / Nº Rodajas	cm	Kg	Pack
60519	326,90	9 / 8 rodajas · 4,5 / 16 rodajas	25x51x50	9,40	1

AL  
Aluminium

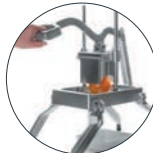

**Mango empujador robusto para un mejor manejo**  
**Con 2 cuchillas consigue dos tamaños de espesor**  
**Dispositivo de sujeción de seguridad**  
**Patas de goma para una mejor sujeción**

Manche pousseur robuste pour une meilleure manipulation  
Avec 2 lames obtenir deux tailles d'épaisseur  
Dispositif de fixation de sécurité  
Pieds en caoutchouc pour une saisie optimale



Robuster Restehalter für einfache Bedienung  
Mit 2 Messer erlangen zwei Größen der Dicke  
Sicherheitsvorrichtung am Schlitten  
Antirutsch-Gummifüße

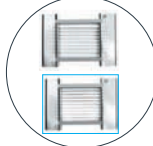

Robust pusher handle for better handling  
With 2 blades get two sizes of thickness  
Safety fastening device  
Rubber feet for better grip

Mango de empurrar robusto para um melhor manejo  
Com 2 lâminas conseguir os dois tamanhos de espessura  
Dispositivo de sujeição de segurança  
Patas de borracha para melhor sujeição



#### **Máquina corta tomates**

Machine pour couper tomates  
Maschine Schneidt Tomaten  
Tomato cutter machine  
Máquina cortador tomate

Ref	€	Espesor (mm) / Nº rodajas	cm	Kg	Pack
60510	196,70	5,5 / 9 rodajas	43x20x21	5,20	1

Inox  
18/10



**Asa de gran robustez para transportar la máquina**  
**10 cuchillas para un perfecto laminado**  
**Bandeja recoge alimentos**  
**Ventosas de sujeción**

Anse extrêmement robuste pour transporter la machine  
10 lames pour une plastification parfaite  
Plateau destiné au ramassage des aliments  
Préhension ventouses



Extrem robuster Tragegriff  
10 Klingeneine für perfekte Laminierung  
Servierplatte  
Greif Saugnäpfe

Robust handle for carrying the machine  
10 blades for a perfect lamination  
Food collection tray  
Gripping suckers

Asa de grande robustez para transportar a máquina  
10 lâminas para uma laminação perfeita  
Bandeja recolhadora de alimentos  
Ventosas de sujeição



**Máquina corta patatas y gajos**

Machine pour chips trancheuse et wedger  
Maschine chip Schneider und Wedger  
Potato chips slicer and wedger machine  
Máquina cortador batatas e gomos



**Colóquelo donde quiera (mesa-pared-tabla)**  
**4 cuchillas diferentes; 7x7 mm / 10x10 mm / 15x15 mm / 8 gajos**  
**Estructura desmontable y fácil limpieza**

Placer où (table-mur-table)  
4 lames différentes; 7x7 mm / 10x10 mm / 15x15 mm / 8 coins  
Structure démontable et facile à nettoyer



Legen Sie sie, wo immer (Tabelle-Wand-Bohle)  
4 verschiedenen Klingen; 7x7 mm / 10x10 mm / 15x15 mm / 8 Scheiben  
Leicht zu reinigende auseinandermontierbare Struktur

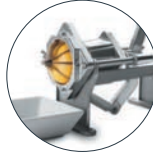

Place it wherever (table-wall-board)  
4 different blades; 7x7 mm / 10x10 mm / 15x15 mm / 8 wedges  
Collapsible structure and easy cleaning

Coloque-o onde quer (tabela- parede-tabela)  
4 lâminas diferentes; 7x7 mm / 10x10 mm / 15x15 mm / 8 cunhas  
Estrutura desmontável e de fácil limpeza

Ref	€	Dados (mm)	Gajos	cm	Kg	Pack
60513	181,60	7x7 / 10x10 / 15x15	8	26x26x42	8,0	1



**Corta patatas chip 3 cortadores**

Coupe-Frites 3 Lames  
Pommes Frites-Schneider, 3 Klingen  
Potato Chips Cutter 3 Blades  
Corta-batatas chip 3 cortadores



**Colóquelo donde quiera (mesa-encimera-tabla)**  
**3 cuchillas diferentes; 6x6 mm / 8x8 mm / 10x10 mm**  
**Estructura desmontable y fácil limpieza**

Placer où (table-worktop-table)  
3 lames différentes; 6x6 mm / 8x8 mm / 10x10 mm  
Structure démontable et facile à nettoyer

Legen Sie sie, wo immer (Tabelle-Arbeitsplatte -Bohle)  
3 verschiedenen Klingen; 6x6 mm / 8x8 mm / 10x10 mm  
Leicht zu reinigende auseinandermontierbare Struktur

Place it wherever (table-worktop-board)  
3 different blades; 6x6 mm / 8x8 mm / 10x10 mm  
Collapsible structure and easy cleaning

Coloque-o onde quer (tabela- bancada-tabela)  
3 lâminas diferentes; 6x6 mm / 8x8 mm / 10x10 mm  
Estrutura desmontável e de fácil limpeza

Ref.	€	Dados (mm)	Pack
60343	168,60	6x6 / 8x8 / 10x10	1



**Máquina corta patatas vertical**

machine pour chips trancheuse vertical  
Vertikale Maschine chip Schneidt  
Vertical chips slicer machine  
Máquina cortador batatas vertical



**Amortiguadores para evitar golpes al cortar los alimentos**  
**Asa empujador robusta para un mejor manejo**  
**Patas de goma para una mejor sujeción**

Amortisseurs pour éviter les coups pendant la coupe des aliments  
Poignée pousseur robuste pour une meilleure manipulation  
Pieds en caoutchouc pour une saisie optimale



Stoßdämpfer für geschmeidigeres Schneiden  
Robuster Restehalter für einfache Bedienung  
Antirutsch-Gummifüße

Shock absorbers to prevent any knocks when cutting food  
Robust pusher handle for better handling  
Rubber feet for better grip



Amortecedores para evitar golpes ao cortar os alimentos  
Asa de empurrar robusto para um melhor manejo  
Patatas de borracha para melhor sujeição

Ref	€	Dados (mm)	cm	Kg	Pack
60511	143,10	10x10	20x20x48	6,0	1



**Máquina corta gajos vertical**  
Verticale trancheuse avec wedger  
Vertikal Wedger Schneider  
Vertical wedger cutter  
Máquina cortador de segmentos vertical



**Amortiguadores para evitar golpes al cortar los alimentos**  
**Asa empujador robusta para un mejor manejo**  
**Patas de goma para una mejor sujeción**

Amortisseurs pour éviter les coups pendant la coupe des aliments  
Poignée pousseur robuste pour une meilleure manipulation  
Pieds en caoutchouc pour une saisie optimale

Stoßdämpfer für geschmeidigeres Schneiden  
Robuster Restehalter für einfache Bedienung  
Antirutsch-Gummifüße

Shock absorbers to prevent any knocks when cutting food  
Robust pusher handle for better handling  
Rubber feet for better grip

Amortecedores para evitar golpes ao cortar os alimentos  
Asa de empurrar robusto para um melhor manejo  
Patas de borracha para melhor sujeição

Ref	€	Gajos	cm	Kg	Pack
60526	216,90	6	29x29x48	5,20	1

## Ganchos



**Gancho carnicero 1 punta (6 pcs.)**

Crochets de boucher 1 conseil  
Metzgerhaken, 1 spitze  
Butchers hook 1 point  
Ganchos de carnicero 1 ponta

	Ref	€	Ø (mm)	L (cm)	Pack
<b>A</b>	39043	8,90	6	12,5	4
<b>B</b>	39044	14,00	6	18,5	4



**Gancho carnicero 2 punta (6 pcs.)**

Crochets de boucher 2 conseil  
Metzgerhaken, 2 spitze  
Butchers hook 2 point  
Ganchos de carnicero 2 ponta

	Ref	€	Ø (mm)	L (cm)	Pack
<b>A</b>	39047	8,90	6	12,5	4
<b>B</b>	39048	14,00	6	18,5	4

## Protección

### Composición / Composition:

62% Polietileno / 62% Polyethylene  
24% Poliéster / 24% Polyester  
14% Fibra de vidrio / 14% Glass fiber



2

Unid.

### Guante protección

Gant de protection  
Schutzhandschuh  
Protection glove  
Luva de protecção

Ref	€	Talla	Medida	Perim. mano L (cm)	Pack
61101	15,40	M	8	182 mm	24
61102	15,40	I	9	192 mm	25
61103	15,40	XI	10	204 mm	26

### Ambidiestro, cómodos y ligeros Para el procesamiento y corte de alimentos NO emplear con sierras giratorias o dentadas

Ambidextres, pratiques et légers  
Pour la transformation et la découpe des aliments  
NE PAS utiliser avec des scies giratoires ou dentées

Beidhändig verwendbar, bequem und leicht  
Zur Bearbeitung und zum Schneiden der Lebensmittel  
NICHT mit Kreissägen oder gezahnten Sägen verwenden

Ambidextrous, comfortable and light  
For the processing and cutting of food  
Do NOT use with rotating or toothed saws

Ambidestro, cómodos e leves  
Para processar e cortar alimentos  
NÃO utilizar com serras giratórias ou dentadas

**Resistencia al corte** **4**  
Blade cut resistance

**Resistencia a la abrasión** **5**  
Abrasion resistance

**Resistencia al punzónado** **4**  
Punction resistance

**Resistencia al desgarro**  
Tear resistance

EN 388



454 X

Certificado CE emitido  
por CTC FRANCE

### Guante cinco dedos con correa en la muñeca Reversible para mano derecha como izquierda Código de identificación para servicio de seguimiento Diseño de correa extraíble y protección completa de mano Fácil lavar y desinfectar

Gant cinq doigts avec courroie au poignet  
Réversible pour main droite ou gauche  
Code d'identification pour service de suivi  
Conception de courroie extractible et protection complète de la main  
Facile à laver et désinfecter

Fingerhandschuh mit Riemen am Handgelenk  
Für rechte und linke Hand wendbar  
Identifikationscode zur Nachverfolgung  
Herausnehmbarer Riemen und vollständiger Handschutz  
Leicht zu reinigen und zu desinfizieren

Five-finger glove with strap on the wrist  
Reversible for both right and left hand  
Identification code for monitoring service  
Detachable strap and complete hand protection design  
Easy to wash and disinfect

Luva de cinco dedos com correia no punho  
Reversível, para a mão direita ou esquerda  
Código de identificação para serviço de seguimento  
Design com correia extraível e proteção total da mão  
Fácil de lavar e desinfetar



UNE EN 1082

CE Directive 89/686/EEC  
and EN 1082-1-1996

### Guante cota

Gant en maille  
Netz-Handschuh  
Chainman glove  
Luva de malha



Ref	€	Talla	Medidas	Perim. mano	Color	Pack
39169	111,90	Small	7	171 mm	Blanco/White	12
39170	111,90	Medium	8	182 mm	Rojo/Red	12
39171	111,90	I arge	9	192 mm	Azul/Blue	12
39172	111,90	X I arge	10	204 mm	Naranja/Orange	12



### Delantal cota de malha

Tablier en maille  
Kettenhemd Schürze  
Metal butcher's apron  
Avental de malha

Ref	€	cm	Perimetro	Pack
39165	260,80	80x55	95-145 cm	1

### Ajustable gracias a sus tirantes verticales y horizontales Conviene asegurarse de que las medidas del cuchillo empleado no sean inferiores a:

Ajustable grâce à ses bandes verticales et horizontales  
Il convient de s'assurer que les dimensions du couteau utilisé ne sont pas inférieures à :

Anpassbar, dank seiner vertikalen und horizontalen Feststellvorrichtung  
Sie sollten sich vergewissern, dass die Größen der verwendeten Messer nicht kleiner sind als:

Adjustable thanks to its vertical and horizontal straps  
Care must be taken to ensure that the knife used does not measure less than:

Ajustável graças aos seus tirantes verticais e horizontais  
É conveniente certificar-se de as dimensões da faca utilizada não serem menores de:

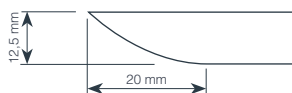

UNE EN 1082

EN ISO 13998: 2003  
NIVEL / LEVEL: 2



## Ceramic

**Mango ergonómico antideslizante, con un diseño moderno e innovador**  
Resistentes, ligeros e higiénicos. NO oxida los alimentos  
Con funda protectora

Manche ergonomique antidérapant, le tout avec un design moderne et novateur  
Résistants, légers et hygiène. NO oxyde alimentaire  
Avec fourreau de protection

Ergonomisch gestalteter Griff mit modernem, innovativen Design sorgt  
Beständig, leicht und Hygiene. NO oxidiert Lebensmittel  
Mit Schutzhülle

Ergonomic non-slip handles, modern and innovative design  
Resistant, light and hygiene. NO oxidizes food  
With protective sheath

Cabo ergonómico antideslizante, con um desenho moderno e inovador  
Resistentes, leves e higiene. NÃO oxida os alimentos  
Com capa protectora



**Chaira DIAMANTE**  
Fusil à affûter DIAMANT  
Wetzstahl, DIAMANT  
DIAMOND sharpening steel  
Fusil DIAMANTE



Ref	€	cm	Pack
39075	28,20	21	8

### Cuchillo cocina KAIFU

Couteau de cuisine  
Küchenmesser  
Kitchen knives  
Faca cozinha

	Ref	€	cm	Pack
<b>A</b>	39308	6,60	8	8
<b>B</b>	39310	7,10	10	8
<b>C</b>	39312	11,20	12	8
<b>D</b>	39315	15,80	15	8
<b>E</b>	39318	23,20	18	8
<b>F</b>	39313	12,50	12	8



**Cuchillo cocina**  
Couteau de cuisine  
Küchenmesser  
Kitchen knives  
Faca cozinha

	Ref	€	cm	Pack
<b>A</b>	39208	8,50	8	8
<b>B</b>	39210	9,40	10	8
<b>C</b>	39212	15,80	12	8
<b>D</b>	39215	20,60	15	8
<b>E</b>	39218	30,50	18	8
<b>F</b>	39213	19,00	12	8



## Professional

**Cuchillo CHEF**

Couteau de chef  
Messer Chef  
Cook's knife  
Faca Chef

Ref	€	cm	Pack
49016	5,40	16	12
49021	8,00	21	12
49025	9,40	25	12
49030	10,30	30	12

**Cuchillo cocina**

Couteau de cuisine  
Küchenmesser  
Kitchen knife  
Faca cozinha

Ref	€	cm	Pack
49110	3,80	10	12
49112	3,80	12	12
49116	4,30	16	12
49121	5,70	21	12

**Cuchillo patatero**

Couteau office  
Gemüsemesser  
Paring knife  
Faca batatas

Ref	€	cm	Pack
49185	3,40	8,50	12

**Cuchillo jamonero**

Couteau à jambon  
Schinkenmesser  
Ham knife  
Faca de presunto

Ref	€	cm	Pack
49024	6,50	26	12

**Cuchillo deshuesador**

Couteau à désosser  
Ausbeinmesser  
Boning knife  
Faca desossador

Ref	€	cm	Pack
49014	4,20	14	12

**Cuchillo pan**

Couteau à pain  
Brotmesser  
Bread knife  
Faca de pão

Ref	€	cm	Pack
49027	6,00	21	12

**Tenedor de trinchar**

Fourchette de chef  
Tranchiergabel  
Cook's fork  
Garfo de trinchar

Ref	€	cm	Pack
49017	5,10	18	12

**Cuchillo Santoku**

Couteau Santoku  
Messer Santoku  
Santoku knife  
Faca Santoku

Ref	€	cm	Pack
49210	5,10	10	12
49212	6,20	12	12
49216	8,40	16	12

## Classic

**Cuchillo CHEF**

Couteau de chef  
Messer Chef  
Cook's knife  
Faca Chef

Ref	€	cm	Pack
39016	16,20	16	12
39021	19,90	21	12
39025	22,70	25	12
39030	29,10	30	12

**Cuchillo cocina**

Couteau de cuisine  
Küchenmesser  
Kitchen knife  
Faca cozinha



Ref	€	cm	Pack
39110	8,30	10	12
39112	9,40	12	12
39114	10,70	14	12
39116	12,90	16	12
39118	14,40	18	12
39121	15,00	21	12
39125	16,20	25	12

**Cuchillo deshuesador**

Couteau à désosser  
Ausbeinmesser  
Boning knife  
Faca desossador

Ref	€	cm	Pack
39014	12,90	14	12

**Cuchillo patatero**

Couteau ofice  
Gemüsemesser  
Paring knife  
Faca batatas

Ref	€	cm	Pack
39185	8,70	8,50	12

**Cuchillo fiambre, pastel**

Couteau pour charcuterie  
Wurst-/Gyrosmesser  
Salame slicer  
Faca fiambre e doce

Ref	€	cm	Pack
39023	15,10	21	12

**Cuchillo jamonero**

Couteau à jambon  
Schinkenmesser  
Ham knife  
Faca de presunto

Ref	€	cm	Pack
39020	16,70	21	12
39024	18,80	26	12

**Cuchillo pan**

Couteau à pain  
Brotmesser  
Bread knife  
Faca de pão

Ref	€	cm	Pack
39027	15,10	21	12

**Cuchillo congelados**

Couteau aliments surgelés  
Gefrierwarenmesser  
Frozen food knife  
Faca congelados

Ref	€	cm	Pack
39028	15,70	21	12

**Tenedor de trinchar**

Fourchette de chef  
Tranchiergabel  
Cook's fork  
Garfo de trinchar

Ref	€	cm	Pack
39017	13,40	18	12

**Cuchillo Pescado / Fileteador**

Couteau filet-de-sole  
Filiermesser  
Filetting/fish knife  
Faca peixe / Filetes

Ref	€	cm	Pack
39115	10,50	20	12

**Machete**

Couperet  
Hackfleischmesser  
Cleaver  
Cutelo

Ref	€	cm	Pack
39015	43,60	16	1

**Chaira**

Fusil à affûter  
Wetzstahl  
Sharpening steel  
Fusil

Ref	€	cm	Pack
39010	16,90	21	10

**Taco 6 / 8 piezas**

6 pcs bloc  
Messerhalter Set, 6-tlg  
6 pc bloc  
Taco 6 peças

Ref	€	Piezas	Pack
39000	106,90	6	1 6 piezas
39001	130,80	8	1 8 piezas

**COMPOSICIÓN (6 pcs.):**

- \* Cuchillo Chef 21 cm (39021)
- \* Cuchillo de cocina de 10 cm (39110)
- \* Cuchillo de cocina de 16 cm (39116)
- \* Cuchillo deshuesador 14 cm (39014)
- \* Cuchillo jamonero 20 cm (39020)
- \* Chaira (39010)

**COMPOSICIÓN (8 pcs.):**

- \* Cuchillo Chef 21 cm (39021)
- \* Cuchillo de cocina de 10 cm (39110)
- \* Cuchillo de cocina de 16 cm (39116)
- \* Cuchillo deshuesador 14 cm (39014)
- \* Cuchillo jamonero 20 cm (39020)
- \* Cuchillo pan (39027)
- \* Tenedor trinchar (39017)
- \* Chaira (39010)

**Maleta 9 piezas**

9 pcs mallette de chef  
Messertasche, 9-tlg  
9 pc cook's case  
Mala 9 peças

Ref	€	Pack
39004	282,50	1

**COMPOSICIÓN:**

- \* Cuchillo de cocina de 10 cm (39110)
- \* Cuchillo de cocina de 18 cm (39118)
- \* Cuchillo de cocina de 25 cm (39125)
- \* Cuchillo deshuesador 14 cm (39014)
- \* Cuchillo jamonero 20 cm (39020)
- \* Cuchillo Chef 25 cm (39025)
- \* Tenedor trinchar (39017)
- \* Macheta (39015)
- \* Chaira (39010)



## Juego cuchillos

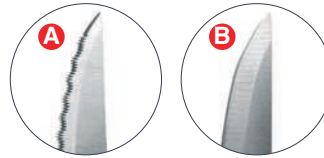

### Set 6 cuchillos chuleteros

6 couteau steak,  
6 steakmesser,  
6 pcs steak knives  
Conjunto 6 facas carne

	Ref	€	L (cm)	Pack
<b>A</b>	39060	12,40	21	12
<b>B</b>	39061	11,80	21	12



### Taco 5 cuchillos

5 couteaux de Chef  
5 Messer Chef Set  
5 Chef knife set  
Taco 5 facas Chef

Ref	€	Pack
39064	52,10	6



### Soporte magnético cuchillos

Support magnetique pour couteaux  
Magnethalterung für Messer  
Magnet support for knives  
Suporte magnético de facas

Ref	€	L (cm)	Pack
39008	7,30	38	12
39009	8,80	55	12

### Cuchillo corta verduras

Couteau pour coupe légumes  
Gemüsemesser  
Vegetables knife  
Faca corta verduras



Ref	€	L (cm)	Pack
60386	1,40	18	24

## Afilador · Abrelatas

### Afilador de cuchillos

Affûteuse de couteaux  
Schärfmaschine  
Knife sharpener  
Afiador de facas



Ref	€	Pack
39065	7,30	6

### Afilador de cuchillos eléctrico

Affûteuse de couteaux électrique  
Elektrische Schärfmaschine  
Electric knife sharpener  
Afiador de facas electrónico



Ref	€	Pack
69141	24,30	6

**Fase 1:** Alta abrasividad · High abrasiveness

**Fase 2:** Afilado fino · Thin sharp

**Fase 3:** Micro-afilado · Micro-sharp



Fase 1 Fase 2 Fase 3



### Afilador de cuchillos eléctrico

Affûteuse de couteaux électrique  
Elektrische Schärfmaschine  
Electric knife sharpener  
Afiador de facas electrónico



Ref	€	Pack
69261	80,80	1

### Afilador de cuchillos eléctrico

Affûteuse de couteaux électrique  
Elektrische Schärfmaschine  
Electric knife sharpener  
Afiador de facas electrónico

Ref	€	Pack
60359	38,30	6

Ref	Tensión/Voltage	Potencia/Power	Dimensiones/Sizes	Peso/Weight
69261	220-240 V / 50-60 Hz	80 W	32x11,5x10 cm	2,20 Kg
69141	220-240 V / 50 Hz	60 W	13,5x15x9 cm	0,64 Kg
60359	220-240 V / 50-60 Hz	60 W	16x11x7,5 cm	0,56 Kg



### Abrelatas de mesa

Ouvre-boîte de table  
Dosenöffner für Tisch  
Table tin opener  
Abre-latas de mesa

Ref.	€	Pack	
63005	102,20	1	Negro (Black)
63015	150,60	1	Inox 18/10

Altura máx. de lata: 30 cm  
Maxime height of caniste: 30 cm

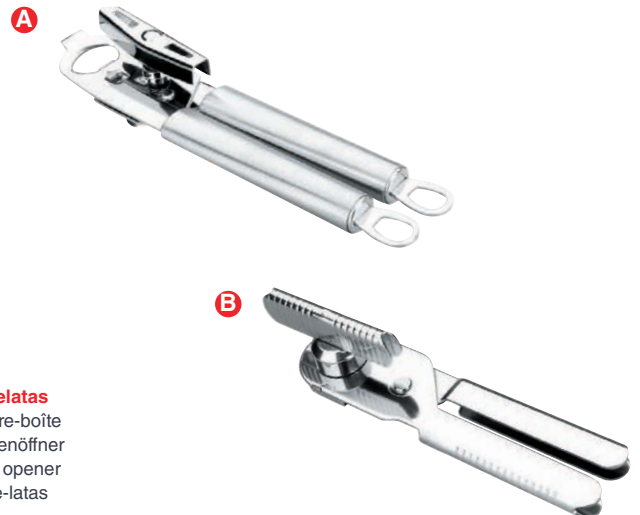

### Abrelatas

Ouvre-boîte  
Desenöffner  
Can opener  
Abre-latas

	Ref	€	cm	L (cm)	Pack
A	62689	21,40	5x4	20	12
B	63038	17,90	5x4	17	6

## Tablas de corte



**Fabricada en bambú natural, robusta y muy resistente**  
**Gracias a la rejilla las migas quedan recogidas (60487-60491-64495)**  
**Ref 69494 Ideal para verter los alimentos cortados en las olla o cacerolas**  
**Mejor ergonomía que una tabla normal. Ocupa poco espacio**

Fabriqué en bambou naturel, robuste et très résistante  
 Ramassage des miettes avec la grille (60487-60491-64495)  
 R69494 Idéale pour verser les aliments coupés dans les faitouts ou les casseroles  
 Meilleure ergonomie qu'une planche à découper classique. Prend peu de place

Aus Naturbambus gefertigt, robust und sehr widerstandsfähig  
 Krümmel werden dank des Gitters aufgefangen (60487-60491-64495)  
 R69494 Ideal um geschnittene Lebensmittel in Pfannen und Töpfe zu geben  
 Punktet gegenüber normalen Brettern mit verbesserter Ergonomie.  
 Platzsparend

Made of natural, hardwearing and highly resistant bamboo  
 Crumbs are collected thanks to the wire rack (60487-60491-64495)  
 R69494 Ideal for tipping cut food into the pot or pan  
 Better ergonomics than a normal cutting board. Occupies little space

Fabricada em bambu natural, robusta e muito resistente  
 As migas são recolhidas graças à rede (60487-60491-64495)  
 R69494 Ideal para verter os alimentos cortados no tacho ou na panela  
 Mais ergonómica do que uma tábua de cortar normal. Ocupa pouco espaço.

### Tabla de corte pan

Planche à découper pain  
 Schneidebrett brot  
 Bread cutting board  
 Tábua de corte pão



Ref	€	cm	Pack
60487	22,60	40x30x2	6



### Tabla de corte pan oval

Planche à découper pain ovale  
 Schneidebrett oval brot  
 Oval bread cutting board  
 Tábua de corte pão oval



Ref	€	cm	Pack
60491	28,20	40x27x3	6

### Tabla de corte pan

Planche à découper pain  
 Schneidebrett brot  
 Bread cutting board  
 Tábua de corte pão



Ref	€	cm	h (cm)	Pack
60495	17,80	50x15	2	6



### Tabla de corte FLEX

Planche à découper  
 Schneidebrett  
 Cutting board  
 Tábua de corte



Ref	€	Extendida (cm)	h (cm)	Pack
60494	18,00	37,8x21,5	1	6



### Tabla de corte DUAL

Planche à découper  
 Schneidebrett  
 Cutting board  
 Tábua de corte



Ref	€	cm	h (cm)	Pack
60492	28,80	39,5x38	4	6

### Reversible gracias a sus dos topes

**Perfecta para colocar sobre la encimera evitando el deslice en el corte**  
**Contiene un canal que recoge el jugo de la carne y el zumo de la fruta cortada**

Réversible grâce à ses deux points de fixation  
 Elle est parfaite pour placer sur le plan de travail en évitant le glissement lors de la découpe  
 Contient un canal qui recueille le jus de la viande ainsi que le jus des fruits coupés

Beidseitig verwendbar  
 Seine zwei Blöcke verhindern das Verrutschen auf der Arbeitsfläche beim Schneiden  
 Verfügt über eine Rinne, die den Saft von Fleisch und geschnittenem Obst auffängt

This double-sided chopping board is reversible  
 Ideal for placing on the worktop to prevent sliding while cutting  
 Includes a groove that collects the juices from the chopped meat and fruit

Reversível graças às suas duas batentes  
 Perfeita para colocar sobre o tampo evitando que escorregue ao cortar  
 Contém uma calha que recolhe o suco da carne e o sumo da fruta cortada

**Tabla de corte  
RUBBER WOOD**

Planche à découper  
Schneidebrett  
Cutting board  
Tábua de corte



Ref	€	cm	Pack
60488	27,80	33x25x4	5
60485	54,60	53,3x32,8x4	4



**Robusta**

**Las fibras colocadas verticalmente ayudan a mantener el filo de los cuchillos afilado durante más tiempo**

**Tabla de corte tratada con un revestimiento protector y anti-bacteriana**

Robuste

Les fibres placées verticalement aident à maintenir le fil de la lame des couteaux aiguisés plus longtemps

Planche à découper traitée avec un revêtement de protection et antibactérien

Robust

Die vertikal verlaufenden Fasern tragen dazu bei, die Messerklingen länger scharf zu halten

Das Schneidebrett wurde mit einem antibakteriellen Schutzüberzug behandelt

Robust

The fibres are arranged vertically to help knife blades retain their sharpness for longer

Cutting board treated with a protective and anti-bacterial coating

Robusta

As fibras colocadas verticalmente ajudam a manter o fio das facas afiado durante mais tempo

Tábua de cortar tratada com um revestimento protetor e antibacteriano

**Tabla de corte redonda  
RUBBER WOOD**

Planche à découper rond  
Schneidebrett, Rund  
Round cutting board  
Tábua de corte redonda



Ref	€	Ø (cm)	h (cm)	Pack
60489	44,40	40	4	4



**Fabricada en robusta madera de acacia. Superficie de corte en cristal con un Ø25 cm**  
**Incluye 4 cuchillos fabricados en acero inoxidable con mango de madera**  
**Ideal para cortar quesos y presentarlos sobre la misma**

Fabriquée en bois d'acacia robuste. Surface de découpe en verre avec un Ø de 25 cm  
Inclut 4 couteaux fabriqués en acier inoxydable avec manche en bois  
Idéale pour couper le fromage et le présenter à table

Aus robustem Akazienholz gefertigt. Schneidefläche aus Glas mit einem Durchmesser von Ø25 cm  
Dazu gehören 4 Messer aus Edelstahl mit Holzgriff  
Ideal zum Käse schneiden und präsentieren

Made of sturdy acacia wood. Ø25cm glass cutting surface  
Includes 4 stainless steel knives with wooden handles  
Ideal for cutting and serving cheese

Fabricada em madeira de acácia de grande robustez. Superfície de corte de vidro, com Ø25 cm  
Inclui 4 facas de aço inoxidável, com cabo de madeira  
Ideal para cortar e apresentar queijos

**Set de cuchillos para Queso**

Jeu de couteaux pour le fromage  
Set von Messern für Käse  
set knives for cheese  
Jogo de facas para queijo

Ref	€	Ø (cm)	h (cm)	Pack
60072	37,50	25	5	4



**Tabla de corte DUAL**

Planche à découper  
Schneidebrett  
Cutting board  
Tábua de corte

Ref	€	cm	h (cm)	Pack
60459	21,90	35x43	5	6



**Reversible gracias a sus dos topes**

**Perfecta para colocar sobre la encimera evitando el deslice en el corte**

**Contiene un canal que recoge el jugo de la carne y el zumo de la fruta cortada**

Réversible grâce à ses deux points de fixation

Elle est parfaite pour placer sur le plan de travail en évitant le glissement lors de la découpe  
Contient un canal qui recueille le jus de la viande ainsi que le jus des fruits coupés

Beidseitig verwendbar

Seine zwei Blöcke verhindern das Verrutschen auf der Arbeitsfläche beim Schneiden  
Verfügt über eine Rinne, die den Saft von Fleisch und geschnittenem Obst auffängt

This double-sided chopping board is reversible

Ideal for placing on the worktop to prevent sliding while cutting

Includes a groove that collects the juices from the chopped meat and fruit

Reversível graças às suas duas batentes

Perfeita para colocar sobre o tampo evitando que escorregue ao cortar

Contém uma calha que recolhe o suco da carne e o sumo da fruta cortada





**Tabla de corte Polietileno**

Planche à découper en Polyéthylène  
Schneidebret Polyethylen  
Polyethilene cutting board  
Tábua de corte Polietileno

Ref	€	cm	Pack
60501	6,20	30x18x1	20
60502	8,40	36x22x1	20
60503	11,50	42x25,5x1	20



**Tabla de corte Polietileno**

Planche à découper en Polyéthylène  
Schneidebret Polyethylen  
Polyethilene cutting board  
Tábua de corte Polietileno

Ref	€	cm	Pack
60504	6,10	27x23x1	6
60505	8,30	30x25x1	6
60506	9,90	33x27x1	6



**Tacos antideslizantes**

Cales antidérapantes  
Rutschfesten Aufsätzen  
Non slip plugs  
Tacos anti-deslizantes



**Cepillo para tablas de corte polietileno**

Brosse pour planche à découper  
Brush für Schneidebrett, polyäthylen  
Brush for polythylene cutting board  
Cepilho para tábua de corte polietileno



Ref	€	cm	Pack
60458	53,70	17x6x10	8

**Tabla de corte Polietileno**

Planche à découper en Polyéthylène  
Schneidebret Polyethylen  
Polyethilene cutting board  
Tábua de corte Polietileno

GN 1/4 · 265x162				GN 1/2 · 325x265				GN 1/1 · 530x325				60x40			
Ref	€	h (mm)	Pack	Ref	€	h (mm)	Pack	Ref	€	h (mm)	Pack	Ref	€	h (mm)	Pack
60569	8,40	20	6	60455	16,50	20	6	60456	32,70	20	6	60457	46,10	20	4
				60405	24,30	30	6	60406	48,70	30	6	60407	68,20	30	2



**Tacos antideslizantes**

Cales antidérapantes  
Rutschfesten Aufsätzen  
Non slip plugs  
Tacos anti-deslizantes



**Tabla de corte Polietileno**

Planche à découper en Polyéthylène  
Schneidebrett, Polyäthylen  
Polyethylen cutting board  
Tábua de corte polietileno

GN 1/4 · 265x162x20			GN 1/2 · 325x265x20			GN 1/1 · 530x325x20		
Ref	€	Pack	Ref	€	Pack	Ref	€	Pack
60570	8,40	1	60470	16,50	1	60475	32,60	1
60571	8,40	1	60471	16,50	1	60476	32,60	1
60572	8,40	1	60472	16,50	1	60477	32,60	1
60573	8,40	1	60473	16,50	1	60478	32,60	1
60574	8,40	1	60474	16,50	1	60479	32,60	1
60577	8,40	1	60480	16,50	1	60481	32,60	1

- Pescado · Fish
- Verduras+frutas · Vegetables+Fruits
- Embutidos · Cold cred meat
- Carne · Meat
- Aves · Poultry
- Varios · Divers

PE-500 (HD-HMW) High Molecular AA Weight Polyethylene

**Tacos antiadeslizantes**

Cales antidérapantes  
rutschfesten Aufsätzen  
Non slip plugs  
Tacos anti-deslizantes

**Especial para preparar comidas que no contengan alérgenos  
Identifíquela rápidamente por su intenso color morado**

Spéciale pour préparer des repas sans allergènes  
Identifiez-la rapidement grâce à son intense couleur violette

Zum Bereiten von allergenfreien Speisen  
Leicht an leuchtender lila Farbe zu erkennen

Specially made for making food that contains no allergens  
Identify it quickly by its deep purple colouring

Especial para preparar comidas que não contenham alergénios  
Identifique-a rapidamente pela sua cor roxo vivo

**Tabla de corte antialérgica**

Planche à découper  
Schneidebrett  
Anti-allergy cutting board  
Tábua de corte

GN 1/2 · 325x265x20

GN 1/1 · 530x325x20

Ref	€	Pack	Ref	€	Pack
60521	19,30	1	60522	38,70	1

PE-500 (HD-HMW) High Molecular AA Weight Polyethylene

**Tacos antideslizantes**

Cales antidérapantes  
Rutschfesten Aufsätzen  
Non slip plugs  
Tacos anti-deslizantes

**Jamonero Polietileno abatible**

Support pour jambon en Polyéthylène rabattable  
Schinkenhalter aus Polyethylen, Verstellbar  
Folden ham-support in Polyethylene  
Suporte presunto Polietileno abatible

Ref	€	cm	Pack
62359	74,20	43x19x5	6

**Tacos antideslizantes**

Cales antidérapantes  
Rutschfesten Aufsätzen  
Non slip plugs  
Tacos anti-deslizantes

**Jamonero Polietileno**

Support pour jambon en Polyéthylène  
Schinkenhalter, Polyäthylen  
Polyrhylene ham-support  
Suporte presunto polietileno

Ref	€	cm	Pack
62344	75,30	50x20,5x35,5	1

## Tijeras



### Tijera-Cuchillo SANTOKU desmontable

Ciseaux amovible SANTOKU  
Abnehmbare Schere SANTOKU  
Dismountable scissors SANTOKU knife  
Tesoura removível SANTOKU

Ref	€	L (cm)	Pack
60060	6,70	23,50	12



### Tijera-Desescamador desmontable

Ciseaux Ecailleur amovible  
Abnehmbare Schere-Fischschuppenentferner  
Dismountable scissors-Scraper  
Tesoura-Raspador removível

Ref	€	L (cm)	Pack
60061	4,30	23,00	12



### Tijeras 5 cortes + Peine de limpieza

Ciseaux 5 coupe + peigne pour nettoyage  
5-fach Schneideschere + Reinigungs Kamm  
5 Cuts vegetable scissor+cleaning comb  
Tesouras 5 cortes + Pente de limpeza

Ref	€	cm	Pack
60022	6,20	27x13x3	12



Soporte magnético  
Magnetic holder

### Tijeras cocina con funda

Ciseaux pour cuisine avec housse  
Geflügelschere mit Überzug  
Kitchen scissor with sheath  
Tesouras de cozinha com capa

Ref	€	L (cm)	Pack
60059	7,90	21,5	6



### Tijeras de cocina AVES

Ciseaux pour volaille AVES  
Geflügelschere, AVES  
AVES poultry shears  
Tesouras de cozinha AVES

Ref	€	cm	Pack
60001	15,40	7,5x27	12

- 1.- Tijeras · Scissors
- 2.- Abrebotellas · Unscrew
- 3.- Cascanueces · Nut cracker

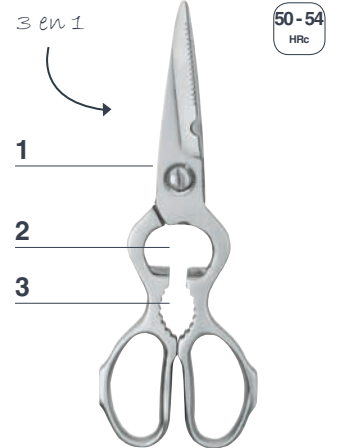

### Tijeras Profesional Inox

Ciseaux Profesional en Inox  
Geflügelschere Profesional  
St. Steel Professional scissors  
Tesouras Profissional Inóx

Ref	€	cm	Pack
38010	17,00	7,0x20	12

### Tijeras de cocina

Ciseaux pour cuisine  
Geflügelschere  
Kitchen shears  
Tesouras de cozinha

	Ref	€	cm	Pack
<b>A</b>	60018	8,70	8,5x21	12
<b>B</b>	60019	8,50	8,5x22	12
<b>C</b>	60023	8,90	8,5x24	12



## Cubiertos



- Cuchara mesa** · Table spoon
- Tenedor mesa** · Table fork
- Cuchillo mesa** · Table knife
- Cuchara postre** · Dessert spoon
- Tenedor postre** · Dessert fork
- Cuchillo postre** · Dessert knife
- Cuchara café** · Coffee spoon
- Cuchara moka** · Moka spoon
- Tenedor Lunch** · Lunch fork
- Tenedor pescado** · Fish fork
- Pala pescado** · Fish knife
- Cazo sopa** · Soup ladle
- Cuchara servir** · Serving spoon
- Tenedor servir** · Serving fork
- Cacillo salsa** · Gravy shovel
- Pala pastel** · Cake shovel

**Soporte cubiertos con vasos**

Porte couverts avec paniers  
Besteckbehälter  
St. Steel cutlery holder w/cylinder  
Suporte talheres com copos

Ref.	€	cm	Orif.	Pack
33124	65,50	29x22x26	4	4
33126	79,70	29x22x38	6	4

**Vasos Inox cubertería**

Panier pour porte couvert  
Besteckköcher  
St. Steel cutlery cylinder  
Copos p/talheres Inóx



Ref.	€	h (cm)	Pack
33125	6,10	14	6

## Hotel

Inox  
18% Cr

Espesor · Thickness: 1,8 mm



Ref	€	Pack
33101	1,30	12
33102	1,30	12
33103	2,20	12
33104	1,10	12
33105	1,10	12
33106	2,10	12
33107	0,80	12
33108	0,70	12
33109	0,80	12
33110	1,10	12
33111	1,10	12
33112	8,40	12
33113	4,60	12
33114	4,60	12
33115	6,10	12
33116	4,70	12

- Cuchara mesa** · Table spoon
- Tenedor mesa** · Table fork
- Cuchillo mesa** · Table knife
- Cuchara postre** · Dessert spoon
- Tenedor postre** · Dessert fork
- Cuchillo postre** · Dessert knife
- Cuchara café** · Coffee spoon
- Cuchara moka** · Moka spoon
- Tenedor Lunch** · Lunch fork
- Tenedor pescado** · Fish fork
- Pala pescado** · Fish knife
- Cazo sopa** · Soup ladle
- Cuchara servir** · Serving spoon
- Tenedor servir** · Serving fork
- Cacillo salsa** · Gravy shovel
- Pala pastel** · Cake shovel

## Aries

Inox  
18/10

Espesor · Thickness: 2,5 mm



Ref	€	Pack
33401	2,10	12
33402	2,10	12
33403	4,70	12
33404	2,10	12
33405	2,10	12
33406	4,70	12
33407	1,10	12
33408	1,00	12
33409	1,30	12
33410	2,10	12
33411	2,10	12
33412	8,20	12
33413	5,00	12
33414	5,10	12
33415	6,50	12
33416	5,60	12

- Cuchara mesa** · Table spoon
- Tenedor mesa** · Table fork
- Cuchillo mesa** · Table knife
- Cuchara postre** · Dessert spoon
- Tenedor postre** · Dessert fork
- Cuchillo postre** · Dessert knife
- Cuchara café** · Coffee spoon
- Cuchara moka** · Moka spoon
- Tenedor Lunch** · Lunch fork
- Tenedor pescado** · Fish fork
- Pala pescado** · Fish knife
- Cazo sopa** · Soup ladle
- Cuchara servir** · Serving spoon
- Tenedor servir** · Serving fork
- Cacillo salsa** · Gravy shovel
- Pala pastel** · Cake shovel









BUFFET  
•  
BUFFET

Chafing Dish  
Buffet



**Tapa con descenso amortiguado para un cierre suave**  
**Tapa extraíble verticalmente para su limpieza**  
**Visor de cristal para mejor uso**  
**Las gotas de condensación retornan a la cubeta**  
**Salsera lateral para la sujeción de cacillos o espumaderas**  
**Disponibilidad de aro complementario para el empleo de placa de inducción**

Couvercle avec descente amortie pour une fermeture en douceur  
 Couvercle peut s'extraire verticalement pour un nettoyage aisé  
 Écran en verre pour une meilleure utilisation  
 Les gouttelettes de condensation retombent dans la cuvette  
 Saucière latérale pour la fixation de louches ou d'écumoirs  
 Disponibilité d'anneaux complémentaires pour l'utilisation de plaques à induction

Deckel mit gefederter Abwärtsbewegung für sanftes Schließen  
 Deckel zwecks einfacher Reinigung vertikal abnehmbar  
 Schauglas für optimalen Gebrauch  
 Rückfluss der Kondenstropfen in den Wasserbehälter  
 Seitliche Sauciere für die Ablage von Schöpfkelle oder Schaumlöffel nach Gebrauch  
 Zusatzringe für den Einsatz von Induktionsplatten verfügbar

Cover with damping seal for smooth closure  
 Cover can be removed vertically for easy cleaning  
 Glass display for better visibility  
 The condensation droplets return to the receptacle  
 Lateral sauceboat for holding scoops and skimmers  
 Availability of additional rings for the use of induction hobs

Tampa com descida amortecida que se fecha suavemente  
 Tampa pode ser extraída verticalmente para facilitar a limpeza  
 Visor de vidro para facilitar a sua utilização  
 As gotas de condensação regressam à cuvette  
 Molheira lateral para sujeitar as conchas ou escumadeiras  
 Anéis complementares disponíveis para utilizar em placas de indução

## Luxe



### Chafing Dish LUXE GN 1/1

Bain marie Luxe GN 1/1  
Chafing Dish, GN-Einsatz 1/1, Luxe  
GN 1/1 Luxe chafing dish  
Chafing dish Luxe GN 1/1 steel

Ref	€	cm	h (cm)	L	Pack
69091	809,30	47x59,5	25,0	9,0	1



### Cuerpo Chafing Dish LUXE GN 1/1

Corps bain marie Luxe GN 1/1  
Chafing Dish Körpe, GN-Einsatz 1/1, Luxe  
GN 1/1 Luxe chafing dish body  
Corpo chafing dish Luxe GN 1/1

Ref	€	cm	h (cm)	L	Pack
69099	651,20	43x59	20,0	9,0	1



### Soporte Chafing Dish LUXE GN 1/1

Support Bain marie Luxe GN 1/1  
Chafing Dish, GN-Einsatz 1/1, Luxe  
GN 1/1 Luxe chafing dish stand  
Suporte chafing dish Luxe GN 1/1

Ref	€	cm	h (cm)	Pack
69089	158,10	41x55	17,0	1



### Placa inducción con regulador

Plaque à induction avec regulateur  
Rouind induction plate with power control  
Placa de indução com regulador

Ref	€	W	Ø (cm)	Pack
69131	91,20	1000	Ø24x8	1

Placa encastrable. Necesita agujero de Ø216 mm para introducirla.  
Encastable plate. Need a Ø216 mm hole to insert the plate.

### Aro complemento Chafing Dish

Support plaque induction  
Zusatzring chafing-dish  
Chafing-dish heater holder  
Aro complemento chafing dish

Ref	€	Ø (cm)	Pack
R69099B	15,00	26	50



### Salsera Chafing Dish

Saucière chafing-dish Luxe  
Sauciere Chafing Dish, Luxe  
Gravy spoon holder  
Molheira chafing dish

Ref	€	cm	h (cm)	L	Pack
R69099C	12,70	12x23	4,0	0,40	1







**Chafing Dish LUXE GN 2/3**

Bain marie Luxe GN 2/3  
Chafing Dish, GN-Einsatz 2/3, Luxe  
GN 2/3 Luxe chafing dish  
Chafing dish Luxe GN 2/3

Ref	€	cm	h (cm)	L	Pack
69092	644,30	43x46	25,5	5,5	1



**Cuerpo Chafing Dish LUXE GN 2/3**

Corps bain marie Luxe GN 2/3  
Chafing Dish Körpe, GN-Einsatz 2/3, Luxe  
GN 2/3 Luxe chafing dish body  
Corpo chafing dish Luxe GN 2/3

Ref	€	cm	h (cm)	L	Pack
69095	509,00	41x43	20,0	5,5	1



**Soporte Chafing Dish LUXE GN 2/3**

Support Bain marie Luxe GN 2/3  
Chafing Dish, GN-Einsatz 2/3, Luxe  
GN 2/3 Luxe chafing dish stand  
Suporte chafing dish Luxe GN 2/3

Ref	€	cm	h (cm)	Pack
69087	135,40	40x37	17,0	1



**Placa inducción con regulador**

Plaque à induction avec regulateur  
Induktionskochfeld mit regler  
Round induction plate with power control  
Placa de indução com regulador

Ref	€	W	Ø (cm)	Pack
69131	91,20	1000	Ø24x8	1

Placa encastrable. Necesita agujero de Ø216 mm para introducirla.  
Encastable plate. Need a Ø216 mm hole to insert the plate,

**Aro complemento Chafing Dish**

Support plaque induction  
Zusatzring chafing-dish  
Chafing-dish heater holder  
Aro complemento chafing dish



Ref	€	Ø (cm)	Pack
R69099B	15,00	26	50

**Salsera Chafing Dish**

Saucière chafing-dish Luxe  
Sauciere Chafing Dish, Luxe  
Gravy spoon holder  
Molheira chafing dish



Ref	€	cm	h (cm)	L	Pack
R69099C	12,70	12x23	4,0	0,40	1



**Chafing Dish LUXE GN 1/2**

Bain marie Luxe GN 1/2  
Chafing Dish, GN-Einsatz 1/2, Luxe  
GN 1/2 Luxe chafing dish  
Chafing dish Luxe GN 1/2 steel

Ref	€	cm	h (cm)	L	Pack
69093	580,80	32,5x46	25,5	4,0	1



**Cuerpo Chafing Dish LUXE GN 1/2**

Corps bain marie Luxe GN 1/2  
Chafing Dish Körper, GN-Einsatz 1/2, Luxe  
GN 1/2 Luxe chafing dish body  
Corpo chafing dish Luxe GN 1/2

Ref	€	cm	h (cm)	L	Pack
69094	469,00	43x32	20,0	4,0	1



**Soporte Chafing Dish LUXE GN 1/2**

Support Bain marie Luxe GN 1/2  
Chafing Dish, GN-Einsatz 1/2, Luxe  
GN 1/2 Luxe chafing dish stand  
Suporteo chafing dish Luxe GN 1/2

Ref	€	cm	h (cm)	Pack
69088	111,80	40x28	17,0	1



**Placa inducción con regulador**

Plaque à induction avec regulateur  
Induktionskochfeld mit regler  
Round induction plate with power control  
Placa de indução com regulador

Ref	€	W	Ø (cm)	Pack
69139	91,20	700	Ø18x8	1

Placa encastrable. Necesita agujero de Ø155 mm para introducirla.  
Encastable plate. Need a Ø155 mm hole to insert the plate.

**Aro complemento Chafing Dish**

Support plaque induction  
Zusatzring chafing-dish  
Chafing-dish heater holder  
Aro complemento chafing dish



Ref	€	Ø (cm)	Pack
R69094A	15,20	18	50

**Salsera Chafing Dish**

Saucière chafing-dish Luxe  
Sauciere Chafing Dish, Luxe  
Gravy spoon holder  
Molheira chafing dish



Ref	€	cm	h (cm)	L	Pack
R69099C	12,70	12x23	4,0	0,40	1



**Chafing Dish LUXE SOPA**

Bain marie Luxe soupiere  
Suppen Chafing Dish, Luxe  
Luxe soup chafing dish  
Chafing dish Luxe sopa

Ref	€	Ø (cm)	h (cm)	L	Pack
69098	488,10	45	38,0	11,0	1



**Cuerpo Chafing Dish LUXE SOPA**

Corps bain marie Luxe soupiere  
Suppen Chafing Dish Körpe, Luxe  
Luxe soup chafing dish body  
Corpo chafing dish Luxe sopa

Ref	€	cm	h (cm)	L	Pack
69100	353,90	42x48	34,0	11,0	1



**Soporte Chafing Dish LUXE SOPA**

Support bain marie Luxe soupiere  
Unterstützung suppen Chafing Dish  
Luxe soup chafing dish stand  
Suporte chafing dish Luxe sopa

Ref	€	cm	h (cm)	L	Pack
69097	134,10	41x32	17,0		1



**Placa inducción con regulador**

Plaque à induction avec regulateur  
Induktionskochfeld mit regler  
Round induction plate with power control  
Placa de indução com regulador

Ref	€	W	Ø (cm)	Pack
69131	91,20	1000	Ø24x8	1

Placa encastrable. Necesita agujero de Ø216 mm para introducirla.  
Encastable plate. Need a Ø216 mm hole to insert the plate.

**Aro complemento Chafing Dish**

Support plaque induction  
Zusatzring chafing-dish  
Chafing-dish heater holder  
Aro complemento chafing dish

Ref	€	Ø (cm)	Pack
R69100B	15,20	27	50



**Contenedor Chafing Dish LUXE SOPA**

SOUPIERE Bain marie Luxe  
Suppenbehälter chafing Dish, Luxe  
Luxe soup container chafing dish  
Recipiente chafing dish Luxe sopa

Ref	€	Ø (cm)	h (cm)	L	Pack
R69100A	19,80	29	22,0	11,0	1



**Salsera Chafing Dish**

Saucière chafing-dish Luxe  
Sauciere Chafing Dish, Luxe  
Gravy spoon holder  
Molheira chafing dish

Ref	€	cm	h (cm)	L	Pack
R69099C	12,70	12x23	4,0	0,40	1





**Chafing Dish LUXE REDONDO**

Bain marie Luxe ronde  
Chafing Dish, rund, Luxe  
Luxe round chafing dish  
Chafing dish Luxe redondo steel

Ref	€	cm	h (cm)	L	Pack
69101	633,40	46,5x53	25,0	6,0	1



**Cuerpo Chafing Dish LUXE REDONDO**

Corps bain marie Luxe ronde  
Chafing Dish Körpe, rund, Luxe  
Luxe round chafing dish body  
Corpo chafing dish Luxe redondo

Ref	€	cm	h (cm)	L	Pack
69096	499,30	50x45	20,0	6,0	1



**Soporte Chafing Dish LUXE SOPA**

Support bain marie Luxe soupier  
Unterstützung suppen Chafing Dish  
Luxe soup chafing dish stand  
Suporte chafing dish Luxe sopa

Ref	€	cm	h (cm)	Pack
69097	134,10	41x32	17,0	1



**Placa inducción con regulador**

Plaque à induction avec regulateur  
Induktionskochfeld mit regler  
Round induction plate with power control  
Placa de indução com regulador

Ref	€	W	Ø (cm)	Pack
69131	91,20	1000	Ø24x8	1

Placa encastrable. Necesita agujero de Ø216 mm para introducirla.  
Encastable plate. Need a Ø216 mm hole to insert the plate.

**Fuente para Chafing Dish redondo**

Plat rond pour Bain marie ronde  
Einsatz für Chafing Dish, rund  
Food pan for round chafing dish  
Travessa para Chafing dish redondo



Ref	€	Ø (cm)	Pack
69019	48,20	35x7	1

**Aro complemento Chafing Dish**

Support plaque induction  
Zusatzring chafing-dish  
Chafing-dish heater holder  
Aro complemento chafing dish



Ref	€	Ø (cm)	Pack
R69100B	15,20	27	50

**Salsera Chafing Dish**

Saucière chafing-dish Luxe  
Sauciere Chafing Dish, Luxe  
Gravy spoon holder  
Molheira chafing dish



Ref	€	cm	h (cm)	L	Pack
R69099C	12,70	12x23	4,0	0,40	1



## Chafing Dish



### Chafing Dish 1/1 Roll Top patas latón

Bain marie 1/1 roll top pieds en laiton  
Chafing Dish, mit GN-Einsatz, Rolldeckel  
Chafing dish 1/1 roll top brass legs  
Chafing dish 1/1 roll top patas latão

Ref	€	cm	h (cm)	L	Pack
69015	613,10	53x32,5	6,50	9,0	1



### Chafing Dish Roll patas chapa GN 1/1

Bain marie roll top GN 1/1 avec pieds en inox  
Chafing Dish, mit GN-Einsatz 1/1, Rolldeckel  
Chafing Dish GN 1/1 w/sheet legs  
Chafing dish roll patas Chapa GN 1/1

Ref	€	cm	h (cm)	L	Pack
69034	550,10	53x32,5	6,50	9,0	1



### Chafing Dish Roll Top GN 1/1

Bain marie roll top GN 1/1  
Chafing Dish, mit GN-Einsatz 1/1, Rolldeckel  
Chafing dish roll GN 1/1  
Chafing dish roll top GN 1/1

Ref	€	cm	h (cm)	L	Pack
69001	563,20	53x32,5	6,50	9,0	1



### Chafing Dish Standard GN1/1

Bain marie standard GN 1/1  
Chafing Dish Standard, mit GN-Einsatz 1/1  
Chafing dish Standard GN 1/1  
Chafing dish Standard GN 1/1

Ref	€	cm	h (cm)	L	Pack
69004	280,00	53x32,5	6,50	9,0	1

Cubeta interior (66165)  
Inside container



### Chafing Dish BASIC GN1/1 con tapa

Bain marie BASIC GN 1/1 avec couvercle en inox  
Chafing Dish, BASIC, mit GN-Einsatz 1/1 mit Deckel, Rostfrei  
BASIC Chafing Dish GN 1/1 with st. steel lid  
Chafing Dish BASIC GN 1/1 com tampa en .

Ref	€	cm	h (cm)	L	Pack
69110	84,60	56x35	28,0	8,5	1



Adapt. a Ref  
69015 - 69001 - 69004 - 69110

### Calentador eléctrico para Chafing

Corp de chauffe pour bain marie  
Elektro-Heizung  
Electric heating unit for chafing dish  
Aquecedor eléctrico para chafing dish

	Ref	€	W	Pack
A	69002	150,90	700	1
B	69012	174,50	700	1

Con regulador · With regulador

## Servidores · Calentadores

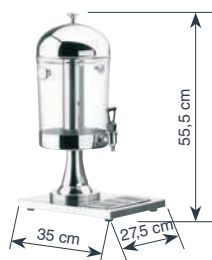
**Servidor de zumos pie cromado**

Distributeur de jus en inox  
Saftbehälter mit rostfreiem Fuss  
Juice dispenser mirror stand  
Distribuidor de zumos pé cromado

	Ref	€	L	Pack
	69027	269,70	8,70	1
<b>A</b>	R69018	23,50	Grifo	1
<b>B</b>	R69027	76,30	Contenedor	1

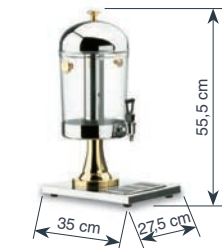
**Servidor de zumos**

Distributeur de jus  
Saftbehälter  
Juice dispenser  
Distribuidor de zumos

	Ref	€	L	Pack
	69018	269,70	8,70	1
<b>A</b>	R69018	23,50	Grifo	1
<b>B</b>	69020	64,10	Contenedor	1

**Calentador de líquidos BUFFET**

Chauffe-café  
Getränkbehalter  
Coffee urn  
Aquecedor de líquidos

	Ref	€	L	Pack
	69028	303,00	11,0	1
<b>A</b>	R69018	23,50	Grifo	1

**Contenedor de combustible**

Porte-brûleur  
Brennpasten-Behälter  
Burner holder  
Recipiente de combustible



	Ref	€	Ø (cm)	h (cm)	Asa L (cm)	Pack
<b>A</b>	69006	19,40	9,0	6,0	7,0	1

**Lata gel combustible ETANOL**

Boîte gel chauffe ETHANOL  
Brennpaste, ETHYALKOHOL  
Fuel gel can, ETHANOL  
Lata de gel combustible ETANOL



	Ref	€	g	Horas	Pack
	69108	2,10	225	3	72

**Botellas gel ETANOL**

Flacon al alcool gelifie ETANOL  
Flasche, ETHYALKOHOL  
Bottle ETHANOL  
Garrafas de gel ETANOL



	Ref	€	g	Pack
	69107	6,80	840	12

**Bidón gel combustible ETANOL**

Bidon gel chauffe ETHANOL  
Bidon, ETHYALKOHOL  
Fuel gel barrel, ETHANOL  
Bidón de gel combustible ETANOL



	Ref	€	Kg	Pack
	69109	31,10	4,0	72

## Placas de inducción

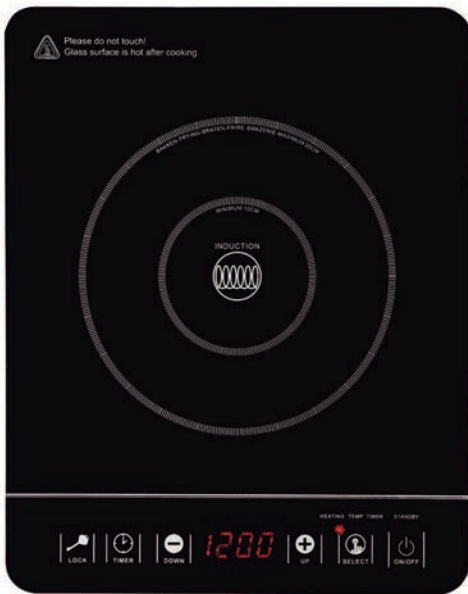

**Placas de inducción rápidas, eficaces, seguras, fiables y de gran capacidad de calentamiento**  
**Sus diseño portátiles y compactos resultan ideales para su uso en cualquier lugar**  
**Botones táctiles, intuitivos y fáciles de utilizar con un toque suave**  
**Disponen de función de bloqueo de seguridad para niños**  
**Regulables en potencia y temperatura**  
**Temporizador de 180 minutos con avisador acústico y auto desconexión**  
**40% ahorro de tiempo y energía respecto a otras placas convencionales**

Plaque à induction rapide, efficace, sûre, fiable et d'une grande capacité de chauffe  
 Sa conception portable et compacte est idéale pour une utilisation n'importe où  
 Boutons tactiles, intuitifs et faciles à utiliser avec un toucher doux  
 Dispose d'une fonction de blocage de sécurité pour les enfants  
 Réglable en puissance et en température  
 Minuteur de 180 minutes avec alerte sonore et arrêt automatique  
 40% de gain de temps et d'économies d'énergies par rapport à d'autres plaques conventionnelles

Schnelles, sicheres, zuverlässiges Induktionskochfeld mit hervorragender Heizleistung  
 Aufgrund seines tragbaren und kompakten Designs ist es überall einsetzbar  
 Intuitive, bedienerfreundliche Soft-Touch-Tastfelder  
 Kindersicherungsfunktion  
 Regulierbare Leistung und Temperatur  
 Zeitschaltuhr bis 180 Minuten mit akustischem Warnsignal und automatischer Abschaltung  
 40 % Zeit- und Energieersparnis verglichen mit anderen herkömmlichen Kochfeldern

Fast, efficient, safe, reliable induction hob with high heating capacity  
 Its portable and compact design is ideal for use anywhere  
 Intuitive and easy to use soft touch buttons  
 Includes a child safety lock function  
 Adjustable power and temperature  
 180-minute timer with audible warning and auto-off  
 40% saving in time and energy compared to other conventional hobs

Placa de indução rápida, eficaz, segura, fiável e de grande potência  
 O seu design portátil e compacto permite a sua utilização em qualquer lugar  
 Botões tácteis, intuitivos e fáceis de utilizar, com um suave toque  
 Função de bloqueio de segurança à prova de crianças  
 Potência e temperatura reguláveis  
 Temporizador de 180 minutos com avisador acústico e desconexão automática  
 Poupança de 40% em tempo e energia, em comparação com as placas convencionais

· Professional use ·

Ø12  
cm

Ø28  
cm



**Placa Inducción Profesional**  
 Plaque Induction Professionnelle  
 Profi-Induktionsplatte  
 Professional induction cooktop  
 Placa de indução Profissional

Ref	€	Pack
69132	347,20	1

Ø12  
cm

Ø22  
cm



**Placa Inducción Profesional**  
 Plaque Induction Professionnelle  
 Profi-Induktionsplatte  
 Professional induction cooktop  
 Placa de indução Profissional

Ref	€	Pack
69337	295,00	1

**New**

Ref	Tensión/Voltage	Potencia/Power	Niveles Pot. /P. levels	Reloj/Timer	Dimensiones/Sizes	Peso/Weight
69132	220-240 V / 50-60 Hz	3500 W	13	0 - 180 min	34x43x12 cm	7,35 Kg
69337	220-240 V / 50-60 Hz	2700 W	10	0 - 180 min	30x37x10 cm	5,40 Kg

· Household use ·

Ø22  
cm  
max



Ø10  
cm    Ø20  
cm



**New**

**Placa de Inducción**

Table de cuisine à induction  
Induktionskochgerät  
Induction Cooker  
Placa de indução

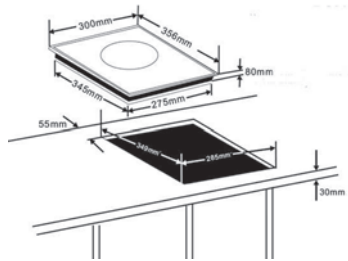

**Posibilidad de encastrar**  
Encastrable option

**Placa de Inducción**

Table de cuisine à Induktion  
Induktionskochgerät  
Induction cooker  
Placa de indução

Ref	€	W	Pack
69332	128,00	2000	1

Ref	€	Pack
69032	228,00	1

Ref	Tensión/Voltage	Potencia/Power	Niveles Pot. /P. levels	Reloj/Timer	Dimensiones/Sizes	Peso/Weight
69032	220-240 V / 50-60 Hz	2000 W	6	0 - 180 min	35x30x6,5 cm	2,90 Kg
69332	220-240 V / 50-60 Hz	2000 W	8	0 - 180 min	30x37x10 cm	3,40 Kg

· Household use ·

Ø16-20  
cm



Ø10  
cm    Ø20  
cm



**New**

**Placa Inducción doble**

Plaque Induction double  
Elektromixer mit Gefäß  
Double induction cooktop  
Placa de indução dupla

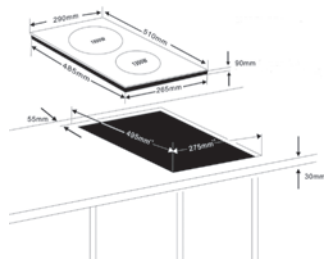

**Posibilidad de encastrar**  
Encastrable option

**Placa Inducción DUAL**

Plaque Induction  
Elektromixer mit Gefäß  
Induction cooktop  
Placa de indução

Ref	€	Pack
69333	218,50	1

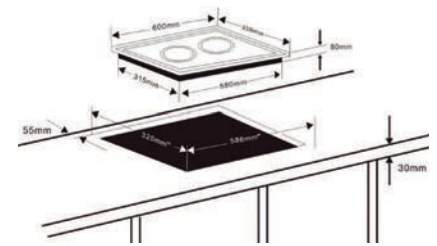

**Posibilidad de encastrar**  
Encastrable option

Ref	€	Pack
69033	369,70	1

Ref	Tensión/Voltage	Potencia/Power	Niveles Pot. /P. levels	Reloj/Timer	Dimensiones/Sizes	Peso/Weight
69033	220-240 V / 50-60 Hz	1800 -1300 W	8	0 - 99 min	29x51x9 cm	4,50 Kg
69333	220-240 V / 50-60 Hz	2000 W + 1500 W	7	0 - 180 min	60x34x7,5 cm	5,20 Kg



· Professional use ·



**Placa Inducción Wok Profesional**

Plaque à induction wok Professionnelle  
Induktionskochplatte Wok Professional  
Induction cooktop wok Professional  
Placa indução wok Profissional

Ref	€	Pack
69138	365,90	1



**Wok semi-esférico Trimetal**

Wok hemispherique Trimetal  
Wok, Schneeschlagkessel, Trimetal  
Trimetal semi-spherical wok  
Wok semi-esférica Trimetal

Ref	€	Ø (cm)	L
53836	142,40	36	5,50

Ref	Tensión/Voltage	Potencia/Power	Temperatura/Temp	Tiempo/Timer	Dimensiones/Sizes	Peso/Weight
69138	220-240 V / 50-60 Hz	3500 W	60°C - 240°C	0 - 180 min	34x44,5x12,5 cm	7,50 Kg

**Placas calentamiento**

· Professional use ·



**Placa calentamiento Eléctrica Inox**

Plaque électrique pour Chauffante  
Warmhalteplatte  
Electrical warming Plate  
Placa aquecimento eléctrica Inóx

Ref	€	Pack
69045	83,90	1

*Platos y bandejas siempre calientes*  
Ensures dishes and trays are always warm

**Una solución perfecta para profesionales de hostelería, buffet, eventos, catering, ferias...**  
**Ideal para mantener tanto platos como bandejas de alimentos calientes antes de servirlos en la mesa a una temperatura perfecta**  
**Termostato regulable en temperatura**  
**Prohibido cocinar sobre la misma placa**

Une solution parfaite pour les professionnels de l'hôtellerie, buffets, événements, traiteurs, salons, ...  
Idéale pour garder au chaud aussi bien les assiettes que les plats d'aliments avant de les servir à table à une température parfaite  
Thermostat réglable en température  
Il est strictement interdit de cuisiner sur la plaque

Die perfekte Lösung für Gastgewerbe, Büffets, Veranstaltungen, Catering, Messen ...  
Ideal, um gefüllte Teller und Tablettis vor dem Servieren am Tisch bei perfekter Temperatur zu halten  
Thermostat mit Temperaturregelung  
Kochen auf der Platte ist nicht gestattet



A perfect solution for hospitality, buffet, events, catering and trade show professionals...  
Ideal for keeping both dishes and trays of food warm before serving them at a perfect temperature  
Temperature-adjustable thermostat  
Do not cook on the hot plate

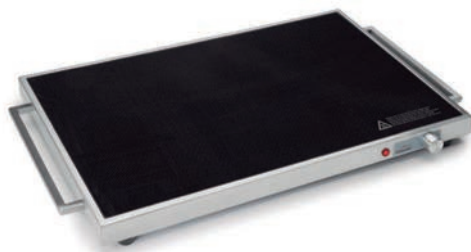

**Placa calentamiento Eléctrica Vitrocerámica**

Plaque vitrocéramique chaleur  
Glaskeramikheizplatte  
Hob heating plate  
Placa aquecimento eléctrica vitrocerámica

Ref	€	Pack
69145	165,60	1

Uma solução perfeita para profissionais da hotelaria, buffets, eventos, catering, feiras...  
Ideal para manter quentes pratos e bandejas de alimentos, para os servir à mesa a uma temperatura perfeita  
Termostato de temperatura regulável  
Nunca cozinhar sobre a própria placa!

Ref	Tensión/Voltage	Potencia/Power	Rango temp/Temp.	Temp. máx/Max. temp.	Dimensiones/Sizes	Peso/Weight
69045	220-240 V / 50-60 Hz	300 W	0° - 80° C	80° C	53x35,5 cm	3,50 Kg
69145	220-240 V / 50-60 Hz	230 W	60° - 105°C (+/- 5°C)	105° C	55x35x5 cm	4,40 Kg

## Lámparas calentamiento

· Professional use ·

### Lámpara calentamiento infrarrojos

Lampe de chauffage infrarouge  
Infrarot Wärmenlampe  
Infrared heating lamp  
Lâmpara calor infravermelho

	Ref	€	Pack
<b>A</b>	69061	116,50	1
<b>B</b>	69361	84,10	1



Ref	Tensión/Voltage	Potencia/Power	Dimensiones/Sizes	Peso/Weight
69061	220-240 V / 50-60 Hz	550 W	36x45x61 - 75 cm	1,58 Kg
69361	220-240 V / 50-60 Hz	275 W	34x33x56 - 71 cm	1,15 Kg

· Professional use ·

### Lámpara de calentamiento infrarrojos

Lampe de chauffage infrarouge  
Infrarot Wärmenlampe  
Infrared heating lamp  
Lâmpara calor infravermelho

	Ref	€	Pack
<b>A</b>	69263	386,80	1
<b>B</b>	69264	502,80	1

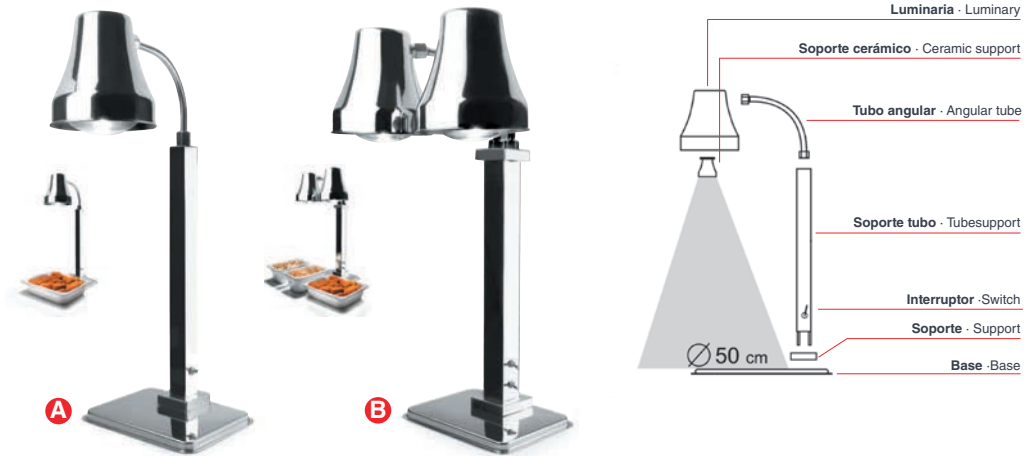

Ref	Tensión/Voltage	Potencia/Power	Dimensiones/Sizes	Peso/Weight
69263	220-240 V / 50-60 Hz	275 W	79x31x23 cm	6,0 Kg
69264	220-240 V / 50-60 Hz	550 W	76x36x36 cm	7,0 Kg

· Professional use ·

### Lámpara de calentamiento infrarrojos cable extensible

Lampe de chauffage infrarouge câble extensible  
Infrarot Wärmenlampe Kabel stretchbar  
Infrared heating lamp rise and full cable  
Lâmpara calor infravermelho cabo extensível

	Ref	€	Pack	
<b>A</b>	69266	96,10	1	Lijado · Sanding
<b>B</b>	69365	110,00	1	Cromado · Chrome <b>New</b>
<b>C</b>	69267	238,90	1	Cobre · Copper <b>New</b>

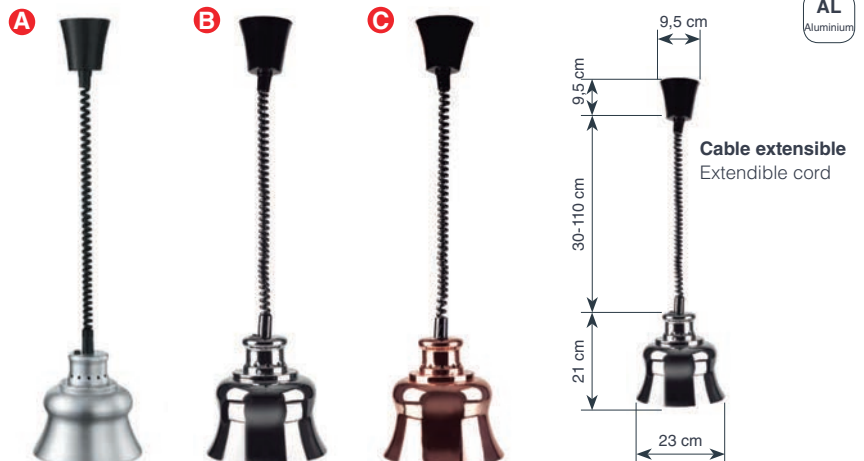

Ref	Tensión/Voltage	Potencia/Power	Dist. lámp.-alimentos Lamp-food distance	Dimensiones/Sizes	Peso/Weight
69266	220-240 V / 50-60 Hz	275 W	50-60 cm	24x24x35 cm	2,0 Kg
69365	220-240 V / 50-60 Hz	275 W	50-60 cm	24x24x35 cm	2,0 Kg
69367	220-240 V / 50-60 Hz	275 W	50-60 cm	24x24x35 cm	2,0 Kg

## Calentadores

· Professional use ·

**Mantiene caliente todo tipo de sopas, salsas, consomés y líquidos  
Ideal para cantidades grandes**

Maintenir au chaud tout type de soupes, sauces, consommés, liquides, etc...  
Idéal pour de grandes quantités

Warmhalten aller Arten von Suppen, Saucen, Konsommées, Flüssigkeiten, usw.  
Ideal für große Mengen

Keep all kinds of soups, sauces, consommés, liquids etc hot  
Ideal for large amounts

Manter quente todo o tipo de sopas, molhos, consomés, líquidos, etc...  
Ideal para grandes quantidades

### Calentador eléctrico de sopa

Chauffe-soupe électrique  
Elektrische Suppenbereiter  
Electric soup heater  
Aquecedor de sopa eléctrico



Ref	€	Pack
69267	238,90	1

### Olla calentador sopa eléctrico

Electrique marmite Buffet chaud  
Elektrischer Suppen-und Speisenwärmer  
Electric soup kettle  
Panela aquecedora de sopa eléctrica



Ref	€	Pack	
69037	140,00	1	Hierro esmaltado
69038	201,00	1	Inox

### Contenedor sopa Inox 10 L

Bac pour soup en inox  
Behälter für elektrischen Wärmer  
St. Steel soup container  
Recipiente sopa Inóx 10 L



Ref	€	Ø (cm)	L
69039	47,00	24x25	10

Ref	Tensión/Voltage	Potencia/Power	Temperatura/Temp.	Capacidad/Capacity	Dimensiones/Sizes	Peso/Weight
69267	220-240 V / 50-60 Hz	800 W	30°C - 90°C	11,0 L	Ø33x32 cm	4,50 Kg
69037	220-240 V / 50-60 Hz	400 - 475 W	30°C - 90°C	10,0 L	Ø34,5x36 cm	4,50 Kg
69038	220-240 V / 50-60 Hz	400 - 475 W	30°C - 90°C	10,0 L	Ø34,5x36 cm	4,50 Kg

· Household use ·

### Fuente de chocolate

Fontaine chocolat  
Schokoladen Fontäne  
Chocolate fountain  
Fonte chocolate

	Ref	€	Torre	Pack
<b>A</b>	69318	49,20	18 cm	1
<b>B</b>	69319	81,40	38 cm	1



Ref	Tensión/Voltage	Potencia/Power	Temperatura/Temp.	Capacidad/Capacity	Torre/Tower	Dimensiones/Sizes	Peso/Weight
69318	220-240 V / 50 Hz	35 W	40 -50°C	0,50 L (max)	18 cm (Height)	Ø16x30 cm	1,15 Kg
69319	220-240 V / 50 Hz	80 W	40 -50°C	1,80 L (max)	38 cm (Height)	Ø23x54,5 cm	2,05 Kg

## Tostadores

· Professional use ·



### Tostadora eléctrica de cinta transportadora

Toasteur électrique professionnel  
Elektrischer Durchlauf toaster  
Electrical conveyor toaster  
Torradeira eléctrica de tapete rolante

Ref	€	Pack
69065	656,40	1
69066	764,60	1



Bandeja recogemigas  
Crumb tray  
Lámp. de cuarzo · Quartz lamps  
L. calentamiento infrarrojos · Infrared heating lamp

### Tostador eléctrico horizontal

Grille-pain électrique horizontal  
Horizontal-/elektrogrill  
Electric horizontal  
Torradeira eléctrica horizontal

	Ref	€	Pack
A	69172	274,10	1
B	69173	330,50	1

Ref	Tensión/Voltage	Potencia/Power	Velocidad/Speed	Producción/Product.	Lámp./Lamps	Parrilla/Grill	Dimensiones/Sizes	Peso/Weight
69065	220-240 V / 50 Hz	1.340 W	0,46 - 0,73 m/min.	150 h	-	-	53x37x40 cm	16 ,0 Kg
69066	220-240 V / 50 Hz	2.240 W	0,46 - 0,73 m/min.	300 h	-	-	53x45x40 cm	19,0 Kg
69172	220-240 V / 50-60 Hz	2.400 W	-	-	4	40x24 cm	50x25x28 cm	8,40 Kg
69173	220-240 V / 50-60 Hz	3.600 W	-	-	6	40x24 cm	50x25x38cm	9,60 Kg

· Semiprofessional use ·



### Tostadora Buffet Inox 4-6 ranuras

Grille-pain buffet pour 4-6 tranches  
Buffet-Toaster für 4-6 Brotscheiben  
4-6 slots st steel buffet toaster  
Torradeira buffet 4-6 fatias de pão

Ref	€	Ranuras	Pack
69294	183,80	4	2
69296	244,20	6	2

· Household use ·



### Tostadora LUXE para 2-4 rebanadas de pan

Grille-pain LUXE pour 2-4 tranches de pain  
LUXE-Toaster für 2-4 Brotscheiben  
LUXE 2-4 slice toaster  
Torradeira LUXE para 2-4 fatias de pão

Ref	€	Ranuras	Pack
69162	65,50	2	1
69164	80,30	4	1

Ref	Tensión/Voltage	Potencia/Power	Selector/Selector	Ranuras/Slots	Dimensiones/Sizes	Peso/Weight
69294	220-240 V / 50-60 Hz	1800 W	2-4 ranuras · 2-4 groves	15x3 cm	37x21x22 cm	4,80 Kg
69296	220-240 V / 50-60 Hz	2500 W	2-4-6 ranuras · 2-4-6 groves	15x3 cm	46x22,5x22 cm	6,00 Kg
69162	220-240 V / 50-60 Hz	850 W	2 ranuras · 2 groves	14x4 cm	32x18x19 cm	2,55 Kg
69164	220-240 V / 50-60 Hz	1400 W	2 ranuras · 2 groves	14x4 cm	32x26x19 cm	2,70 Kg



## Tostadoras ranura larga

· Household use ·



### Termostato: 7 posiciones de tostado

Thermostat: 7 positions grillées  
Thermostat: 7 Positionen geröstet  
Thermostat: 7 positions toasted  
Termostato: 7 posições brindado



### Dispone de función descongelar

Dispose d'une fonction de décongélation  
Mit Auftaufunktion  
It has a defrost function  
Com função de descongelação



### Bandeja recogemigas

Plateau ramasse-miettes  
Krümelbehälter  
Crumb tray  
Bandeja recoge-migalhas



### Patas de apoyo antideslizantes

Pieds d'appui antidérapants  
Rustfeste standfüße  
Non-slip supports  
Patas de apoio antideslizantes

**Fabricada en acero inoxidable 18/10 de gran calidad y resistencia**  
**Permite tostar de forma rápida y sencilla, sin necesidad de añadir grasa alguna**  
**Función de descongelación y cancelación**  
**Regulador ajustable de tueste, elige entre 7 niveles para tostar a tu gusto**  
**Ranura alargada de 25 cm de largo para rebanadas extra largas o para más de una rebanada de pan**  
**Parrilla adicional para calentar bollos o pan**  
**Incorpora una práctica bandeja, donde se depositan las migas**

Fabriquée en acier inoxydable 18/10 d'une grande qualité et résistance  
Permet de griller de façon rapide et simple sans nécessité d'ajouter aucune graisse  
Fonction de décongélation et d'arrêt  
Régulateur de brunissage réglable : choisissez parmi 7 niveaux pour griller selon vos souhaits  
Rainure allongée de 25 cm de longueur pour des tranches extra larges ou pour plus d'une tranche de pain  
Grille supplémentaire pour réchauffer des viennoiseries ou du pain  
Intègre un plateau pratique sur lequel se déposent les miettes

Aus widerstandsfähigem und hochwertigem Edelstahl 18/10  
Für einfaches und schnelles Toasten ohne Fett  
Mit Auftau- und Abbruchtaste  
Einstellbarer Regler mit 7 Bräunungsstufen ganz nach dem eigenen Geschmack  
Extra lange Röstkammer (25 cm) für eine große oder mehrere kleine Brotscheiben  
Zusätzliches Rost zum Erwärmen von Brötchen oder Brot  
Mit praktischer Krumenwanne

Made of strong high quality 18/10 stainless steel  
Fast and easy toasting without the need to use any fatty products  
Defrost and cancel functions  
Adjustable darkness regulator. Choose from 7 levels for toasting as you like.  
Long 25 cm slot for extra wide slices of bread or more than one slice of bread at once  
Additional grill to heat buns or bread  
It has a practical tray for catching crumbs

Fabricada em aço inoxidável 18/10, de grande qualidade e resistência  
Permite tostar de forma rápida e fácil, sem necessidade de acrescentar nenhum tipo de gordura  
Função de descongelação e botão de cancelamento  
Regulador de tostagem com 7 níveis diferentes, para o ajustar ao gosto pessoal  
Ranhura longa de 25 cm para fatias extra longas, ou para mais do que uma fatia de pão  
Grelha adicional para aquecer bolos ou pão  
Incorpora uma prática bandeja para recolher as migalhas

**New**

Ranura alargada de 25 cm de largo  
Long 25 cm slot for extra wide slices



Ranura alargada de 25 cm de largo  
Long 25 cm slot for extra wide slices



**Tostadora eléctrica ranura larga**  
Grille-pain électrique rainure longue  
Elektrotoaster, lange Öffnung  
Long groove electric toaster  
Torradeira eléctrica ranhuras largas

Ref	€	Pack
69360	49,20	1

**Tostadora eléctrica ranura larga**  
Grille-pain électrique rainure longue  
Elektrotoaster, lange Öffnung  
Long groove electric toaster  
Torradeira eléctrica ranhuras largas

Ref	€	Pack
69060	38,70	1

**Hasta fin de existencias** · While stocks last

Ref	Tensión/Voltage	Potencia/Power	Selector/Selector	Dimensiones/Sizes	Peso/Weight
69060	220-240 V / 50-60 Hz	850 W	Una ranura · One groove	17x24x25 cm	1,10 Kg
69360	220-240 V / 50-60 Hz	1000 W	Una ranura · One groove	41X12X18,5 cm	1,40 Kg

· Household use ·



**Doble ranura de enormes dimensiones para tostar cualquier tipo de pan**  
**7 posiciones de calentamiento, tostado uniforme en ambos lados**  
**Opción de descongelar pan**  
**Bandeja recogemigas**

Double rainure de très grandes dimensions pour griller tout type de pain  
 7 positions de chauffe, brunissage uniforme des deux côtés  
 Option de décongélation du pain  
 Plateau ramasse-miettes

Großformatiger Doppelschlitz zum Toasten aller Brotsorten  
 7 Erwärmungspositionen, gleichförmiges Toasten auf beiden Seiten  
 Brotauftau-Option  
 Krümelauffangblech

Huge double slot for toasting any type of bread  
 7 heating positions, uniform toast on both sides  
 Bread defrost option  
 Crumb-collection tray

Dupla ranhura de grandes dimensões, para tostar qualquer tipo de pão  
 7 posições de aquecimento, tostado uniforme de ambos os lados  
 Opção para descongelar pão  
 Bandeja recolhe-migas

**Tostadora doble ranura larga**

Grille pain double rainure longue  
 Doppelte lange offnung toaster  
 Double long groove toaster  
 Dorradeira ranhua large duplo

Ref	€	Pack
69260	47,80	1

Ref	Tensión/Voltage	Potencia/Power	Selector/Selector	Dimensiones/Sizes	Peso/Weight
69260	220-240 V / 50-60 Hz	1200 - 1500 W	Dos ranuras · Two groves	43x20x23 cm	3,10 Kg

**Dispensadores**



**Dispensador de cereales con base**

Distributeur de Cereales sur Pied  
 Cerialenspender mit Fuss  
 Cereal Dispenser with Stand  
 Distribuidor de cereis com base

	Ref	€	Ø (cm)	cm	L	Pack
<b>A</b>	69022	234,50	18,5	24x34x70	10,0	1
<b>B</b>	69023	464,50	18,5	44x34x70	10,0	1

**Dispensador de leche**

Dispensateur de lait en inox 18/10  
 Milchkanne mit Fuß, Rostfrei 18/10  
 St. steel 18/10 milk dispenser with base  
 Distribuidor de leite

	Ref	€	cm	L	Pack
	69030	344,60	22x33x44	5,5	1

## Airpots

· Professional use ·

**New**



**Fácil sistema de apertura**  
Système d'ouverture facile  
Leicht zu öffnen  
Easy open system  
Sistema de abertura fácil

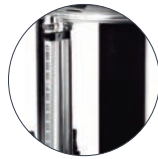

**Nivel de indicador de líquido**  
Niveau d'indicateur de liquide  
Flüssigkeitsfüllstand  
Liquid level indicator  
Nível de indicador do líquido



**Sistema dispensador cómodo**  
Système de distribution pratique  
Bequemes Spendersystem  
Convenient dispensing system  
Prático sistema dispensador



**Sensor de temperatura en el interior**  
Capteur de température à l'intérieur  
Temperaturfühler im Innern  
Interior temperature sensor  
Sensor de temperatura no interior

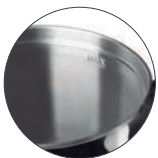

**Marcas de llenado**  
Marques de remplissage  
Füllstandsmarkierungen  
Fill lines  
Marcas de nível de enchimento



**Posibilidad de graduar la temperatura**  
Possibilité de régler la température  
Temperaturregelung möglich  
The temperature can be adjusted  
Possibilidade de graduar a temperatura

*Ideal para agua, café y té*  
*Perfect for water, coffee and tea*

**Dispensador con capacidades de 6 y 10 litros**  
**Fabricado en acero inoxidable resistente y de alta calidad**  
**Dispone de un grifo dispensador con indicador de nivel de líquido**  
**Temperatura controlada por termostato con un rango de 60°C a 100°C**  
**Dispone de asas laterales aislantes del calor para un desplazamiento seguro**  
**NO se recomienda usar con lácteos por la posible contaminación, debido a restos fermentados**  
**Si se usan lácteos es necesario ser cuidadoso y constante en la limpieza del contenedor**

Distributeur d'une capacité de 6 litres et de 10 litres.  
Fabriqué en acier inoxydable résistant et de grande qualité.  
Dispose d'un robinet de distribution avec indicateur du niveau de liquide.  
Température contrôlée par thermostat dans une tranche de 60°C à 100°C  
Dispose de poignées latérales isolantes de la chaleur pour un déplacement sûr  
Il est DÉCONSEILLÉ d'utiliser des produits laitiers en raison de l'éventuelle contamination due aux restes fermentés  
Si vous utilisez des produits laitiers, il faudra être très vigilant et constant en matière de nettoyage du conteneur

Dispenser mit 6 und 10 Liter Füllmenge  
Aus widerstandsfähigem, hochwertigem Edelstahl hergestellt  
Verfügt über einen Spenderhahn mit Flüssigkeitsfüllstandsanzeige  
Temperaturregelung mithilfe eines Thermostats zwischen 60 und 100 °C  
Mit seitlichen, wärmeisolierten Griffen für einen sicheren Transport  
Von der Verwendung von Milchprodukten wird wegen möglicher vorhandener vergärrer Reste ABGERATEN  
Wenn Milchprodukte verwendet werden, ist Sorgfalt geboten und das Behältnis gründlich zu reinigen

6 and 10 litre capacity beverage dispensers  
Made of strong high quality stainless steel  
Includes a spigot with a level indicator  
Temperature controlled by a thermostat with a range from 60° C to 100° C  
Side mounted insulated handles for safe moving  
The dispenser should NOT be used with dairy products due to possible contamination from fermented residue  
If dairy products are used, the dispenser must be cleaned carefully and frequently

Dispensador com capacidade para 6 e 10 litros  
Fabricado em aço inoxidável resistente e de alta qualidade  
Com torneira dispensadora com indicador de nível do líquido  
Temperatura controlada por termóstato regulável de 60 a 100° C  
Dispõe de asas laterais isoladoras do calor para uma deslocação segura  
NÃO se recomenda o seu uso com lácteos pela possível contaminação devido à existência restos fermentados  
Ao utilizar lácteos, é importante ter os devidos cuidados no que se refere à limpeza do recipiente



**Airpot eléctrico**

Électrique Airpot  
Elektrische Getrankenpender  
Electric Airpot  
Airpot eléctrico

Ref	€	L	Pack
69476	112,20	6	1
69471	122,60	10	1

Ref	Tensión/Voltage	Potencia/Power	Capacidad/Capacity	Temperatura/Temp.	Dimensiones/Sizes	Peso/Weight
69476	220-240 V / 50-60 Hz	1500 W	6 L	60°C - 100°C	28x28x40 cm	1,90 Kg
69471	220-240 V / 50-60 Hz	1500 W	10 L	60°C - 100°C	28x28x48 cm	2,00 Kg

· Professional use ·



*Ideal para agua, café y té*  
Perfect for water, coffee and tea



**Sistema de apertura sencillo**  
**Fácil llenado**  
**Tres dispensadores**  
**Función cleaning y base giratoria**  
**Tapa extraíble para su limpieza**  
**Si se usan lácteos es necesario ser cuidadoso y constante en la limpieza del contenedor**

Système d'ouverture simple  
Remplissage facile  
Trois distributeurs  
Fonction Nettoyage et pivotant  
Couvercle amovible pour un nettoyage  
Si vous utilisez des produits laitiers, il faudra être très vigilant et constant en matière de nettoyage du conteneur

Einfache Öffnung system  
Einfache Befüllung  
Drei Spender  
Reinigungsfunktion und Swivel  
Abnehmbarer Deckel für die Reinigung  
Wenn Milchprodukte verwendet werden, ist Sorgfalt geboten und das Behältnis gründlich zu reinigen

Simple opening system  
Easy filling. Three dispensers  
Cleaning function and swivel base  
Removable cover for cleaning  
If dairy products are used, the dispenser must be cleaned carefully and frequently

Sistema simple de abertura  
Fácil enchimento  
Três distribuidores  
Função de limpeza e suporte giratório  
Tampa removível para limpeza  
Ao utilizar lácteos, é importante ter os devidos cuidados no que se refere à limpeza do recipiente

**Airpot eléctrico**

Électrique Airpot  
Elektrische Getrankenpender  
Electric Airpot  
Airpot eléctrico

Ref	€	Pack
69473	87,70	1
69474	92,10	1

Ref	Tensión/Voltage	Potencia/Power	Temperatura/Temp.	Capacidad/Capacity	Dimensiones/Sizes	Peso/Weight
69473	220-240 V / 50-60 Hz	750 W	30°C - 100°C	3,50 L	29x29x35 cm	2,80 Kg
69474	220-240 V / 50-60 Hz	750 W	30°C - 100°C	4,50 L	29x29x39 cm	3,00 Kg

· Professional use ·

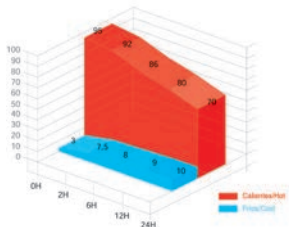

**Air pot**

Air pot  
Getränkespender, isoliert  
Air pot  
SAir pot

Ref	€	L	h (cm)	Pack
62472	54,00	2,50	32,5	1
62473	59,60	3,00	34,5	1
62475	80,00	3,50	39,0	1



**Mantiene las bebidas calientes o frías durante 24 horas**

**Ligero e irrompible**  
**Boca ancha para cubos de hielo**  
**NO utilizar con bebidas gaseosas ni lácteos**

Maintient les boissons chaudes ou froides pendant 24 heures  
Léger et incassable  
Bec large pour glaçons  
NE PAS utiliser avec des boissons gazeuses ni des produits laitiers

Hält die Getränke 24 Stunden warm oder kalt  
Leicht und unzerbrechlich  
Breite Öffnung für Eiswürfel  
NICHT mit Getränken mit Kohlensäure oder Milchprodukten verwenden

Keeps drinks hot or cold for 24 hours  
Light and shatterproof  
Wide mouth for ice cubes  
Do NOT use with fizzy drinks or dairy

Mantém as bebidas quentes e frias durante 24 horas  
Leve e inquebrável  
Abertura larga para cubos de gelo  
NÃO utilizar com bebidas gasosas nem lácteos









GASTRO  
•  
GASTRO

Cubetas  
*Containers*

•  
Transporte  
Estanterías  
*Transport  
Shelves*

•  
Cestas  
*Racks*

•  
Limpieza  
*Cleaning*

## Inox 18/10 • Inox

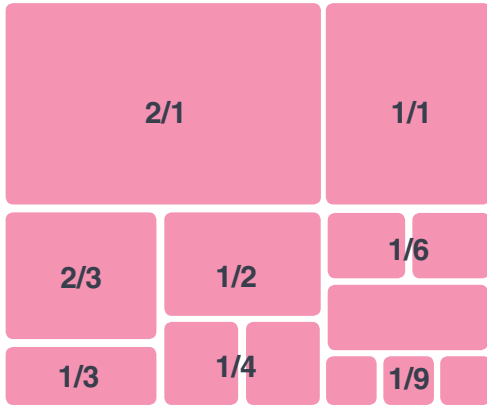

**Fabricadas en acero inoxidable 18/10 acabado mate**  
**Fabricadas en acero inoxidable Serie Aisi 200 acabado brillo**  
**Cumplen con todas las exigencias del mercado profesional**  
**Gama muy completa y precios muy ajustados**

Fabriquéés en acier inoxydable 18/10 finition mate et en acier inoxydable Série Aisi 200 finition brillante  
 Respectent toutes les exigences du marché professionnel  
 Gamme très complète et prix très ajustés

Aus rostfreiem Stahl 18/10 mattes Finish und Aisi 200 hergestellt Hochglanz  
 Sie erfüllen alle Ansprüche der Profi-Branche  
 Umfassende Modellserien und wettbewerbsfähige Preise

Manufactured in 18/19 stainless Steel matte finish and Aisi 200 Series stainless steel gloss finish  
 They comply with all the requirements of the professional market  
 Comprehensive range and very competitive prices

Fabricadas em aço inoxidável 18/10 acabamento fosco e em aço inoxidável  
 Fabricadas em aço série Aisi 200 acabamento brilhante  
 Cumprem com todas as exigências do mercado profissional  
 Gama muito completa e preços muito ajustados

2/1  
530 x 650 mm

### Cubeta 2/1

Bac 2/1  
GN-Behälter 2/1  
Container 2/1  
Caixa 2/1



Inox 18/10	€	Inox	€	h (mm)	L	Pack
66002	39,10	66002Z	34,60	20	6,50	1 Bandeja
66040	43,20	66040Z	39,00	40	11,00	1 Bandeja
66065	49,20	66065Z	41,20	65	18,90	1 Bandeja
66010	60,10	66010Z	50,40	100	31,50	1
66015	72,60	66015Z	63,00	150	44,90	1
66020	94,40	66020Z	84,60	200	60,00	1

### Cubeta Perforada 2/1

Bac perfore 2/1  
GN-Behälter, perforiert, 2/1  
Perforated container 2/1  
Caixa perfurada 2/1

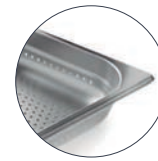

Inox 18/10	€	Inox	€	h (mm)	Pack
-	-	-	-	-	1
66042	53,00	-	-	40	1
66067	66,70	-	-	65	1
66012	82,10	-	-	100	1
66017	122,70	-	-	150	1
66022	236,40	-	-	200	1

### Cubeta 1/1

Bac 1/1  
GN-Behälter 1/1  
Container 1/1  
Caixa 1/1



Inox 18/10	€	Inox	€	h (mm)	L	Pack
66102	19,30	66102Z	16,40	20	3,00	1 Bandeja
66140	19,90	66140Z	17,40	40	5,50	1 Bandeja
66155	22,60	66155Z	18,50	55	7,20	1 Bandeja
66165	24,30	66165Z	19,10	65	8,50	1 Bandeja
66110	34,20	66110Z	25,90	100	13,30	1
66115	40,90	66115Z	35,80	150	20,60	1
66120	48,70	66120Z	43,30	200	30,00	1

### Cubeta Perforada 1/1

Bac perfore 1/1  
GN-Behälter, perforiert, 1/1  
Perforated container 1/1  
Caixa perfurada 1/1

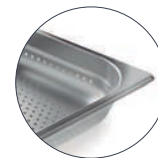

Inox 18/10	€	Inox	€	h (mm)	Pack
66104	29,10	-	-	20	1
66142	34,70	-	-	40	1
-	-	-	-	-	1
66167	38,20	66167Z	21,10	65	1
66112	49,20	66112Z	29,50	100	1
66117	73,00	-	-	150	1
66122	83,80	-	-	200	1

1/1  
530 x 325 mm

2/3  
354 x 325 mm

### Cubeta 2/3

Bac 2/3  
GN-Behälter 2/3  
Container 2/3  
Caixa 2/3



Inox 18/10	€	Inox	€	h (mm)	L	Pack
66502	16,60	66502Z	13,80	20	1,70	1 Bandeja
66540	21,20	66540Z	17,80	40	3,50	1 Bandeja
66565	24,20	66565Z	20,20	65	5,50	1 Bandeja
66510	30,00	66510Z	25,10	100	8,90	1
66515	42,00	66515Z	35,10	150	13,60	1
66520	55,90	66520Z	46,80	200	19,30	1

2/4  
530 x 165 mm

### Cubeta 2/4

Bac 2/4  
GN-Behälter 2/4  
Container 2/4  
Caixa 2/4



Inox 18/10	€	h (mm)	L	Pack
67604	18,20	40	1,80	1
67665	20,70	65	4,50	1
67610	25,60	100	5,50	1
67615	38,80	150	8,50	1

1/2  
265 x 325 mm

**Cubeta 1/2**

Bac 1/2  
GN-Behälter 1/2  
Container 1/2  
Caixa 1/2



Inox 18/10	€	Inox	€	h (mm)	L	Pack	
66202	12,90	66202Z	9,20	20	1,20	1	Bandeja
66240	13,60	66240Z	9,50	40	2,50	1	Bandeja
-	-	66255Z	10,70	55	3,20	1	Bandeja
66265	15,60	66265Z	11,00	65	4,20	1	Bandeja
66210	22,40	66210Z	15,60	100	8,00	1	
66215	28,70	66215Z	22,50	150	9,90	1	
66220	36,70	66220Z	27,80	200	11,60	1	

**Cubeta Perforada 1/2**

Bac perforé 1/2  
GN-Behälter, perforiert, 1/2  
Perforated container 1/2  
Caixa perforada 1/2

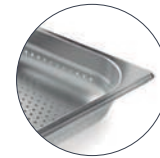

Inox 18/10	€	Inox	€	h (mm)	Pack
-	-	-	-	20	1
66242	24,60	-	-	40	1
-	-	-	-	-	1
66267	28,10	-	-	65	1
66212	34,60	-	-	100	1
66217	46,70	-	-	150	1
66222	64,90	-	-	200	1

1/3  
176 x 325 mm

**Cubeta 1/3**

Bac 1/3  
GN-Behälter 1/3  
Container 1/3  
Caixa 1/3



Inox 18/10	€	Inox	€	h (mm)	L	Pack	
66302	12,20	66302Z	6,90	20	0,80	1	Bandeja
66340	12,30	66340Z	7,60	40	1,60	1	Bandeja
66355	12,60	66355Z	7,80	55	2,00	1	Bandeja
66365	12,80	66365Z	8,00	65	2,50	1	Bandeja
66310	18,00	66310Z	12,70	100	3,80	1	
66315	26,90	66315Z	16,90	150	5,90	1	
66320	30,90	66320Z	20,10	200	8,10	1	

**Cubeta 1/4**

Bac 1/4  
GN-Behälter 1/4  
Container 1/4  
Caixa 1/4



Inox 18/10	€	Inox	€	h (mm)	L	Pack
66402	9,20	66402Z	6,20	20	0,60	1
66465	10,20	66465Z	6,90	65	1,90	1
66410	15,00	66410Z	10,80	100	2,50	1
66415	20,80	66415Z	14,40	150	4,10	1
66420	28,60	66420Z	17,30	200	4,90	1

1/4  
265 x 162 mm

1/6  
176 x 162 mm

**Cubeta 1/6**

Bac 1/6  
GN-Behälter 1/6  
Container 1/6  
Caixa 1/6



Inox 18/10	€	Inox	€	h (mm)	L	Pack
66665	8,40	66665Z	5,50	65	1,10	1
66610	13,30	66610Z	8,50	100	1,60	1
66615	20,80	66615Z	11,90	150	2,50	1
66620	26,10	66620Z	14,10	200	3,30	1

**Cubeta 1/9**

Bac 1/9  
GN-Behälter 1/9  
Container 1/9  
Caixa 1/9



Inox 18/10	€	Inox	€	h (mm)	L	Pack
66965	7,20	66965Z	4,10	65	0,70	1
66910	12,50	66910Z	6,50	100	1,00	1

1/9  
176 x 108 mm

**Guia divisora**

Guide de division  
GN Zwischensteg  
Splitting guides  
Guia divisória



Inox 18/10	€	Inox	€	L (mm)	Pack
66923	11,80	66923Z	5,00	530	1
66925	8,70	66925Z	3,30	325	1

**Doble fondo perforado**

Double fond perforé  
Doppel-Boden gelocht  
Punched double bottom perf.  
Duplo fundo perfurado



Inox 18/10	€	Inox	€	Cubeta
66909	89,40	-	-	2/1
66911	29,20	66911Z	19,40	1/1
66912	20,00	-	-	1/2



**Tapa para cubeta**

Couvercle pour bac  
GN Deckel  
Container lid  
Tampa para caixa



Inox 18/10	€	Inox	€	Cubeta	Pack
66901D	21,70	66901DZ	15,00	1/1	1
66905D	17,20	66905DZ	10,30	2/3	1
66907	14,20	-	-	2/4	1
66902D	11,50	66902DZ	7,40	1/2	1
66903D	9,20	66903DZ	5,60	1/3	1
66904D	7,70	66904DZ	5,20	1/4	1
66906D	5,80	66906DZ	3,10	1/6	1
66909D	5,30	66909DZ	2,40	1/9	1

**Tapa con orificio para cacillo**

Couvercle avec trou pour cuillère à pot  
GN Deckel mit Ausschnitt für Löffel  
Lid with pan bore  
Tampa com orificio para concha



Inox 18/10	€	Cubeta	Pack
66901F	23,50	1/1	1
66905F	15,20	2/3	1
66902F	13,10	1/2	1
66903F	10,60	1/3	1
66904F	8,50	1/4	1
66906F	7,30	1/6	1

**Tapa para cubeta**

Couvercle pour bac  
GN Deckel  
Container lid  
Tampa para caixa



Inox 18/10	€	Cubeta	Pack
67901	21,60	1/1	1
67905	13,20	2/3	1
67902	11,80	1/2	1
67903	8,50	1/3	1
67904	7,20	1/4	1
67906	5,90	1/6	1
67909	5,00	1/9	1

**Tapa GN con junta de silicona**

Couvercle GN avec joint de caoutchouc  
GN Deckel mit Silikondichtung  
GN lid with silicone frame  
Tampa para caixa GN com silicone



200°C  
Max.

Inox 18/10	€	Cubeta	Pack
66901	63,60	1/1	1
66903	51,30	2/3	1
66902	46,60	1/2	1
66904	37,60	1/3	1
66905	35,00	1/4	1

**Parrilla**

Grille  
GN Drahtgitter  
Grill  
Grelha

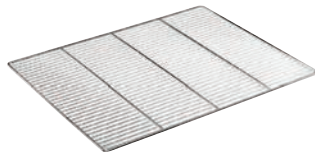

Ref	€	Cm	Cubeta	Pack
66920	43,30	65x53	2/1	1
66921	16,50	53x32,5	1/1	1

**Pinza para horno y bandeja GN**

Pince inox pour bac Gastronorm  
Zange für GN Behälter  
Tong GN tray  
Pinça para forno e bandejas GN



Ref	€	L (cm)	Pack
62989	13,60	20	1

**Pinza con silicona para horno y bandeja**

Pince Inox pour bac Gastronorm avec Silicone  
Zange für GN Behälter, mit Silikon  
Oven tray tong with Silicone  
Pinça para forno e bandejas com silicone



200°C  
max.

Ref	€	L (cm)	Pack
62998	13,70	20	12

## Policarbonato

Fabricadas en policarbonato, ligeras, indeformables y apilables

Aptos para procesos de refrigeración, congelación, hornos microondas o distribución de alimentos (-100°C / 100°C)

Higiénicos y fácilmente lavables, aptos para el lavavajillas

Fabriquéés en polycarbonate, légères, indéformables et empilables

Compatibles pour des processus de réfrigération, congélation, fours à micro-ondes ou distribution d'aliments (-100°C / 100°C)

Hygiéniques et facilement lavables, compatible lave-vaisselle

Aus Polycarbonat hergestellt, leicht, nicht verformbar und stapelbar

Geeignet für Kühl-, Gefriervorgänge, Mikrowellenherde oder Nahrungsmittelverteilung (-100°C / 100°C)

Hygienisch und einfach zu reinigen, geschirrspülerfest

Manufactured in polycarbonate, light, non-deformable and stackable

Suitable for refrigeration and freezing processes, microwave ovens or food distribution (-100°C / 100°C)

Hygienic and easily washable, dishwasher safe

Fabricadas em policarbonato, leves, indeformáveis e empilháveis

Aptos para processos de refrigeração, congelação, fornos micro-ondas ou distribuição de alimentos (-100° C / 100°C)

Higiénicos e facilmente laváveis, apto para a máquina de lavar louça

### Cubeta GN 1/1

Bac GN 1/1

GN-Behälter 1/1

GN container 1/1

Caixa GN 1/1



1/1  
530 x 325 mm

Ref	€	h (mm)	L	Pack
66165P	19,10	65	8,50	1
66110P	23,60	100	13,30	1
66115P	28,90	150	20,60	1
66120P	35,50	200	30,00	1

### Cubeta GN 1/2

Bac GN 1/2

GN-Behälter 1/2

GN container 1/2

Caixa GN 1/2



1/2  
265 x 325 mm

Ref	€	h (mm)	L	Pack
66265P	10,10	65	4,20	1
66210P	13,40	100	8,00	1
66215P	17,30	150	9,90	1
66220P	21,20	200	11,60	1

### Cubeta GN 1/3

Bac GN 1/3

GN-Behälter 1/3

GN container 1/3

Caixa GN 1/3



1/3  
176 x 325 mm

Ref	€	h (mm)	L	Pack
66365P	8,30	65	2,50	1
66310P	10,70	100	3,80	1
66315P	13,30	150	5,90	1
66320P	16,20	200	8,10	1

### Cubeta GN 1/4

Bac GN 1/4

GN-Behälter 1/4

GN container 1/4

Caixa GN 1/4



1/4  
265 x 162 mm

Ref	€	h (mm)	L	Pack
66465P	7,40	65	1,90	1
66410P	8,70	100	2,50	1
66415P	11,00	150	4,10	1

### Cubeta GN 1/6

Bac GN 1/6

GN-Behälter 1/6

GN container 1/6

Caixa GN 1/6



1/6  
176 x 162 mm

Ref	€	h (mm)	L	Pack
66665P	6,20	65	1,10	1
66610P	6,60	100	1,60	1
66615P	7,90	150	2,50	1

### Cubeta GN 1/9

Bac GN 1/9

GN-Behälter 1/9

GN container 1/9

Caixa GN 1/9



1/9  
176 x 108 mm

Ref	€	h (mm)	L	Pack
66910P	6,20	100	0,70	1

### Tapa

Couvercle

Deckel

Lid

Tampa



Ref	€	Cubeta	Pack
66901P	14,70	1/1	1
66902P	9,10	1/2	1
66903P	6,40	1/3	1
66904P	5,30	1/4	1
66906P	4,00	1/6	1
66909P	3,20	1/9	1

### Doble fondo perforado

Double fond perforé

Doppel-Boden gelocht

Punched double bottom perf.

Duplo fundo perforado



Ref	€	Cubeta	Pack
66911P	11,00	1/1	1
66912P	6,10	1/2	1
66913P	3,90	1/3	1
66914P	3,10	1/4	1
66916P	2,80	1/6	1

## Polipropileno



**Fabricadas en polipropileno, ligeras, indeformables y apilables. Cierre hermético. Higiénicos y fácilmente lavables. Aptos para procesos de refrigeración, congelación o distribución de alimentos (-40°C / 70°C)**

Fabriquées en polycarbonate, légères, indéformables et empilables. Fermeture hermétique. Hygiéniques et facilement lavables. Compatibles pour des processus de réfrigération, congélation ou distribution d'aliments (-40°C / 70°C)

Aus Polypropylen hergestellt, leicht, nicht verformbar und stapelbar. Hermetischer Verschluss. Hygienisch und einfach zu reinigen. Geeignet für Kühl-, Gefriervorgänge, Mikrowellenherde oder Nahrungsmittelverteilung (-40°C / 70°C)

Manufactured in polypropylene, light, non-deformable and stackable. Airtight seal. Hygienic and easily washable. Suitable for refrigeration and freezing processes and food distribution (-40°C / 70°C)

Fabricadas em polipropileno, leves, indeformáveis e empilháveis. Fecho hermético. Higiénicos e facilmente laváveis. Aptos para processos de refrigeração, congelação ou distribuição de alimentos (-40° C / 70° C)

### Cubeta 1/1

Bac 1/1  
GN-Behälter 1/1  
Container 1/1  
Caixa 1/1



1/1  
530 x 325 mm

Ref	€	h (mm)	L	Pack
66165H	8,90	65	8,50	6
66110H	10,50	100	13,30	6
66115H	13,20	150	20,60	6
66120H	16,80	200	30,00	6

### Cubeta 1/2

Bac 1/2  
GN-Behälter 1/2  
Container 1/2  
Caixa 1/2



1/2  
265 x 325 mm

Ref	€	h (mm)	L	Pack
66265H	4,60	65	4,20	6
66210H	6,50	100	8,00	6
66215H	7,60	150	9,90	6
66220H	9,00	200	11,60	6

### Cubeta 1/3

Bac 1/3  
GN-Behälter 1/3  
Container 1/3  
Caixa 1/3



1/3  
176 x 325 mm

Ref	€	h (mm)	L	Pack
66365H	3,60	65	2,50	6
66310H	4,40	100	3,80	6
66315H	5,40	150	5,90	6
66320H	6,60	200	8,10	6

### Cubeta 1/4

Bac 1/4  
GN-Behälter 1/4  
Container 1/4  
Caixa 1/4



1/4  
265 x 162 mm

Ref	€	h (mm)	L	Pack
66465H	3,10	65	1,90	6
66410H	4,00	100	2,50	6
66415H	4,40	150	4,10	6

### Cubeta 1/6

Bac 1/6  
GN-Behälter 1/6  
Container 1/6  
Caixa 1/6



1/6  
176 x 162 mm

Ref	€	h (mm)	L	Pack
66665H	2,80	65	1,10	6
66610H	3,00	100	1,60	6
66615H	4,10	150	2,50	6

### Cubeta 1/9

Bac 1/9  
GN-Behälter 1/9  
Container 1/9  
Caixa 1/9



1/9  
176 x 108 mm

Ref	€	h (mm)	L	Pack
66965H	1,90	65	0,70	6
66910H	2,80	100	1,00	6

### Tapa

Couvercle  
Deckel  
Lid  
Tampa



Ref	€	Cubeta	Pack
66901DH	6,60	1/1	6
66902DH	3,80	1/2	6
66903DH	2,80	1/3	6
66904DH	2,30	1/4	6
66906DH	1,60	1/6	6
66909DH	1,50	1/9	6

### Doble fondo perforado

Double fond perforé  
GN Einlege-Böden, gelocht  
Punched double bottom  
Duplo fundo perfurado



Ref	€	Cubeta	Pack
66911H	7,70	1/1	10
66912H	3,80	1/2	12
66913H	2,20	1/3	12
66914H	1,70	1/4	12
66916H	1,20	1/6	12

## Melamina



**Ligeros, indeformables y apilables. Higiénicos y fácilmente lavables, aptos para el lavavajillas**  
**Aptos para procesos de refrigeración, congelación o distribución de alimentos (-40°C / 70°C)**

Légères, indéformables et empilables. Hygiéniques et facilement lavables, compatible lave-vaisselle  
 Compatibles pour des processus de réfrigération, congélation ou distribution d'aliments (-40°C / 70°C)

Leicht, nicht verformbar und stapelbar. Hygienisch und einfach zu reinigen, geschirrspülerfest  
 Geeignet für Kühl-, Gefriervorgänge, Mikrowellenherde oder Nahrungsmittelverteilung (-40°C / 70°C)

Light, non-deformable and stackable. Hygienic and easily washable, dishwasher safe  
 Suitable for refrigeration and freezing processes and food distribution (-40°C / 70°C)

Leves, indeformáveis e empilháveis. Higiénicos e facilmente laváveis, apto para a máquina de lavar louça  
 Aptos para processos de refrigeração, congelação ou distribuição de alimentos (-40° C / 70° C)

1/1  
530 x 325 mm

1/1  
530 x 325 mm

### Cubeta 1/1

Bac 1/1  
GN-Behälter 1/1  
Container 1/1  
Caixa 1/1



Ref	€	h (mm)	L	Pack
66165E	34,70	65	8,50	3
66110E	39,30	100	13,30	3

### Cubeta 1/1

Bac 1/1  
GN-Behälter 1/1  
Container 1/1  
Caixa 1/1



Ref	€	h (mm)	L	Pack
66165J	37,10	65	8,50	3
66110J	41,90	100	13,30	3

1/2  
265 x 325 mm

1/2  
265 x 325 mm

### Cubeta 1/2

Bac 1/2  
GN-Behälter 1/2  
Container 1/2  
Caixa 1/2



Ref	€	h (mm)	L	Pack
66265E	18,00	65	4,50	4
66210E	20,10	100	8,00	4

### Cubeta 1/2

Bac 1/2  
GN-Behälter 1/2  
Container 1/2  
Caixa 1/2



Ref	€	h (mm)	L	Pack
66265J	19,00	65	4,50	4
66210J	21,60	100	8,00	4

1/3  
176 x 325 mm

1/3  
176 x 325 mm

### Cubeta 1/3

Bac 1/3  
GN-Behälter 1/3  
Container 1/3  
Caixa 1/3



Ref	€	h (mm)	L	Pack
66365E	14,10	65	2,50	6
66310E	15,70	100	3,80	6

### Cubeta 1/3

Bac 1/3  
GN-Behälter 1/3  
Container 1/3  
Caixa 1/3



Ref	€	h (mm)	L	Pack
66365J	15,30	65	2,50	6
66310J	16,80	100	3,80	6

1/4  
265 x 162 mm

1/4  
265 x 162 mm

### Cubeta 1/4

Bac 1/4  
GN-Behälter 1/4  
Container 1/4  
Caixa 1/4



Ref	€	h (mm)	L	Pack
66465E	12,10	65	1,90	6
66410E	13,70	100	2,50	6

### Cubeta 1/4

Bac 1/4  
GN-Behälter 1/4  
Container 1/4  
Caixa 1/4



Ref	€	h (mm)	L	Pack
66465J	13,00	65	1,90	6
66410J	14,80	100	2,50	6



2/3  
350 x 325 mm

**Cubeta 2/3**  
 Bac 2/3  
 GN-Behälter 2/3  
 Container 2/3  
 Caixa 2/3



Ref	€	h (mm)	L	Pack
66565E	26,00	65	5,50	6

2/3  
350 x 325 mm

**Cubeta 2/3**  
 Bac 2/3  
 GN-Behälter 2/3  
 Container 2/3  
 Caixa 2/3



Ref	€	h (mm)	L	Pack
66565J	27,50	65	5,50	6

1/6  
176 x 162 mm

**Cubeta 1/6**  
 Bac 1/6  
 GN-Behälter 1/6  
 Container 1/6  
 Caixa 1/6



Ref	€	h (mm)	L	Pack
66665E	8,70	65	1,10	6
66610E	9,80	100	1,60	6

1/6  
176 x 162 mm

**Cubeta 1/6**  
 Bac 1/6  
 GN-Behälter 1/6  
 Container 1/6  
 Caixa 1/6



Ref	€	h (mm)	L	Pack
66665J	9,40	65	1,10	6
66610J	10,50	100	1,60	6

2/4  
530 x 165 mm

**Cubeta 2/4**  
 Bac 2/4  
 GN-Behälter 2/4  
 Container 2/4  
 Caixa 2/4



Ref	€	h (mm)	L	Pack
66765E	18,10	65	4,50	6

2/4  
530 x 165 mm

**Cubeta 2/4**  
 Bac 2/4  
 GN-Behälter 2/4  
 Container 2/4  
 Caixa 2/4



Ref	€	h (mm)	L	Pack
66765J	18,90	65	4,50	6

## Porcelana



**Piezas para el horno pero evite cambios bruscos de temperatura**  
**No sitúe la pieza caliente sobre una superficie de mármol o inoxidable**  
**No vierta líquidos fríos cuando la pieza esté aún caliente**  
**No ponga la pieza directamente en el fuego. Como norma, no tire la pieza y golpee**

Pièces pour le four mais évitez les changements de température brusques  
 Ne pas placer l'élément chaud sur une surface en marbre ou en acier inoxydable  
 Ne pas verser de liquides froids lorsque l'élément est encore chaud  
 Ne pas mettre directement l'élément sur le feu. Évitez également de tirer de l'élément et de le cogner

Die Produkte sind ofenfest, starke Temperaturwechsel sind jedoch zu vermeiden  
 Stellen Sie das Produkt nicht auf eine Oberfläche aus Marmor oder rostfreiem Stahl  
 Gießen Sie keine kalten Flüssigkeiten ein, solange das Produkt noch heiß ist  
 Das Produkt nicht direkt auf das Kochfeld stellen, nicht werfen und nicht anstoßen

Parts for the oven but avoid sharp temperature changes  
 Do not place a hot part on a marble or stainless steel surface  
 Do not pour cold liquids when the part is still hot  
 Do not put the part directly on the heat. As a rule, do not drop or bang the part

Peças para o forno. Evite as mudanças bruscas de temperatura  
 Não situe a peça quente sobre uma superfície de mármore ou inoxidável  
 Não verta líquidos frios quando a peça ainda estiver quente  
 Não coloque a peça diretamente no fogo. Como norma, não tire a peça nem golpeie

### Fuente Porcelana

Plat en Porcelaine  
 Porzellanschale  
 Porcelain tray  
 Travessa porcelana

	Ref	€	Cubeta	h (cm)	ml	Pack
<b>A</b>	66165R	122,50	GN 1/1	6,50	750	1
<b>B</b>	66565R	62,80	GN 2/3	6,50	450	1
<b>C</b>	66265R	45,30	GN 1/2	6,50	340	1
<b>D</b>	66365R	39,10	GN 1/3	6,50	200	1
<b>E</b>	66465R	29,90	GN 1/4	6,50	120	1



### Inserto redondo Porcelana

Bac rond en Porcelaine  
 Chafing dish-Schüssel, rund  
 Porcelain round insert  
 Inserto redondo porcelana

	Ref	€	Ø (cm)	ml	Pack
<b>A</b>	66036R	85,60	37x6,5	420	1
<b>B</b>	66037R	91,90	37x6,5	400	1







Transporte - Estanterías  
Transport - Shelves

#CocinaConLacor



## Termotrans

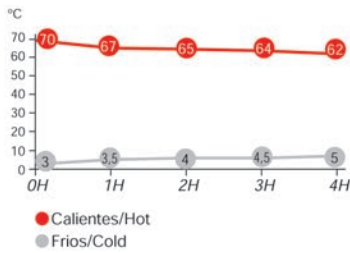

**Diseñado para el transporte de cubetas**  
**Contenedor isotérmico rígido, ligero, robusto y apilable**  
**Puerta sin bisagra, sistema de cierre en la tapa**  
**Ideal para transporte de alimentos en catering o cocinas**

Conçu pour le transport de cuvettes  
 Conteneur isotherme rigide, léger, robuste et empilable  
 Porte sans charnière, système de verrouillage sur le couvercle  
 Idéal pour le transport des aliments de restauration ou de cuisson

Entwickelt für den Transport von Küvetten  
 Thermobehälter starre, leicht, robust und stapelbar  
 Tür ohne Scharnier, Verriegelungssystem des Deckels  
 Ideal für den Transport von Lebensmitteln Catering oder Kochen

Designed for transporting cuvettes  
 Isothermal container rigid, lightweight, sturdy and stackable  
 Door without hinge, locking system on the lid  
 Ideal for transporting food catering or cooking

Projetado para transportar cuvetes  
 Recipiente isotérmico rígida, leve, resistente e empilhável  
 Porta sem dobradiça, sistema de bloqueio sobre a tampa  
 Ideal para o transporte de alimentos em restauração ou cozinhar



1xGN 1/1 - 100

1xGN 2/3 + 1xGN1/3 - 100



2xGN 1/2 - 200

3xGN 1/3 - 200

4xGN 1/4 - 200

### Termotrans 100 17 L

Termotrans  
 Termotrans  
 Termotrans  
 Termotrans

Ref	€	cm	Pack
66099	500,00	41x62x24	1

### Termotrans 300 34 L

Termotrans  
 Termotrans  
 Termotrans  
 Termotrans

Ref	€	cm	Pack
66299	535,30	41x62x37	1



12xGN 1/1-20

6xGN 1/1-65

4xGN1/1-100

3xGN1/1-150

2xGN1/1-200

### Termotrans 600 72L

Termotrans  
 Termotrans  
 Termotrans  
 Termotrans

Ref	€	cm	Pack
66599	661,50	46x63x67	1





## Carros

Tubo AISI 304 Ø25 mm. Espesor chapa 1,6 mm  
 Tube AISI 304 Ø 25 mm. Epaisseur de tôle 1,6 mm  
 Rohr AISI 304 Ø 25 mm. Blechdicke 1,6 mm  
 Tube AISI 304 Ø 25 mm. Sheet thickness 1,6 mm  
 Tubo AISI 304 25 mm. Folha de espessura 1,6 mm



**Carro servicio 2 bandejas desmontable**  
 Amovible chariot de service 2 plateaux  
 Servierwagen, 2 Regale, Abnehmbar  
 Removable service trolley 2 shelves  
 Carro serviço 2 bandejas desmontável

Ref	€	cm	Pack
66249	148,70	89,5x64,5x94,5	1



**Carro servicio 3 bandejas desmontable**  
 Amovible chariot de service 3 plateaux  
 Servierwagen, 3 Regale, Abnehmbar  
 Removable service trolley 3 shelves  
 Carro serviço 3 bandejas desmontável

Ref	€	cm	Pack
66349	192,50	89,5x64,5x94,5	1



**Carro servicio 3 bandejas soldado**  
 Chariot de service 3 plateaux  
 Servierwagen, 3 Regale  
 Service trolley 3 shelves  
 Carro serviço 3 bandejas soldado

Ref	€	cm	Pack
66350	560,40	89,5x64,5x94,5	1



**Carro servicio 3 bandejas plástico**  
 Chariot de service avec 3 plateaux en polyéthylène  
 Servierwagen, 3 Regale aus plastik  
 Service trolley with 3 polyethylene shelves  
 Carro serviço 3 bandejas plástico

Ref	€	cm	Pack
66353	211,70	103x49x95	1

### Contenedor cubiertos plástico

Bac plastique pour couverts  
 Besteckebehälter aus Plastik  
 Cuttlery plastic bin  
 Recipiente de talheres plástico



Ref	€	cm	Pack
66351	31,70	33x23x18	1

### Contenedor desperdicios plástico

Bac à déchets plastique  
 Müllbehälter aus Plastik  
 Rubbish plastic bin  
 Recipiente de desperdícios em plástico



Ref	€	cm	Pack
66352	52,90	33x284x56	1



MAX: Ø30,5 cm  
 MIN: Ø19 cm  
 CAP : 360 unit

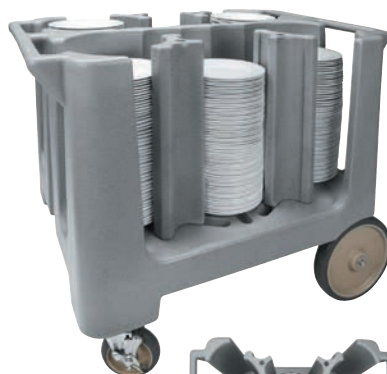

**Carro portaplatos Polipropileno**  
 Chariot porte-plateau  
 Tellerwagen  
 Polypropylene dish cart  
 Carro porta-pratos polipropileno

Ref	€	cm	h (cm)	Pack
66555	1078,50	96x71	81,0	1



### Funda carro portaplatos

Housse chariot porte-plateau  
 Abdeckung für tellerwagen  
 Dish cart cover  
 Capa protectora carro porta-pratos



Ref	€	cm	Pack
62964	39,00	96x71x60	1



MAX: Ø28 cm  
MIN: Ø8 cm  
CAP : 100 unit

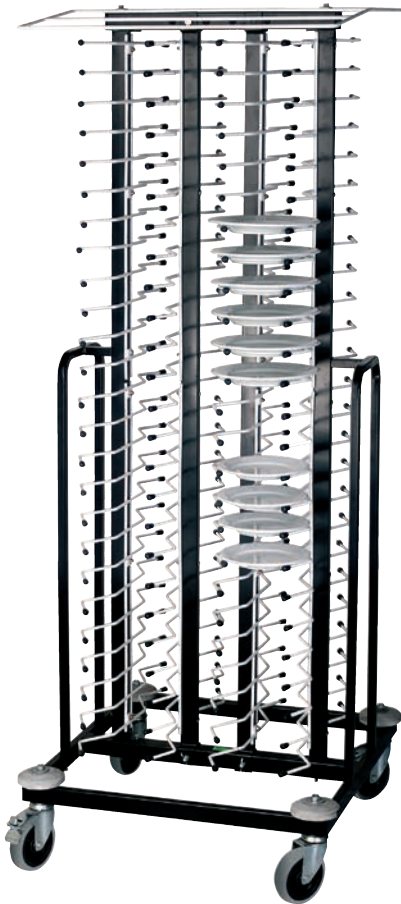

**Carro portaplatos con ruedas 100 platos**

Hors devoirs chariot 100 plate  
Tellertransportwagen 100 teller  
100 Plate stack trolley assembled  
Carro porta-pratos com rodas 100 pratos

Ref	€	cm	Pack
66550	1.356,30	70x70x195	1

**Entrega montado** · Mounted delivery



**Carro portabandejas**

Chariot á glissières  
Gestellwagen  
Rack trolley  
Carro porta-bandejas

Ref	€	Cubeta	Baldas	cm	Pack
66116	740,00	GN 1/1	17	38x55x172	1
66118	821,70	GN 2/1	17	58x69x172	1
66642	692,50	60x40	20	45x62x172	1

**Estante tubular Inox**

Étagère tubulaire en Inox  
Tubuläre Regal, Rostfrei  
St. steel tubular shelf  
Prateleira tubular Inóx

250 mm			
Ref	€	L (mm)	L (mm)
56212	101,10	1200	250
56216	110,10	1600	250

400 mm				
Ref	€	L (mm)	L (mm)	Pack
56412	146,80	1200	400	1
56416	157,10	1600	400	1



## Policarbonato

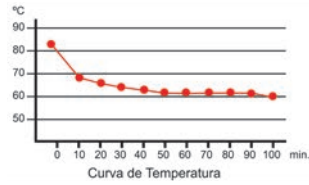

### Rendimiento Térmico de las bandejas

Conservation de la temperature  
Thermoisolierungsrate  
Thermal isolation rate  
Rendimento térmico das bandejas



6 Pcs.



### Bandeja Isotérmica B-1

Plateau Isotherme B-1  
Isothermal Schale/Tablett B-1  
Isothermal B-1, Tray  
Bandeja Isotérmica B-1

Ref	€	cm	Pack
66930	166,00	55x38	1

### Set completo bandeja Isotérmica B-1

Set complet B-1  
Komplet-Set B-1  
Complete set B-1  
Conjunto completo bandeja Isotérmica B-1

Ref	€	cm	Pack
66942	192,80	55x38	1



### Plato llano Policarbonato 22x3 cm con tapa

Assiette plate polycarbonate 22 x 3 cm avec couvercle  
Grosser Teller, Polycarbonat 22 x 3 cm mit deckel  
Polycarbonate dinner plate 22 x 3 cm with lid  
Prato raso policarbonato 22 x 3 cm com tampa

Ref	€	Pack
66933	12,30	1 Conjunto · Set
66933C	8,70	1 Plato · Plate
66940	3,60	1 Tapa · Lid



### Plato hondo Policarbonato 19x5 cm con tapa

Assiette creuse polycarbonate 19 x 5 cm avec couvercle  
Suppenteller, Polycarbonat, 19 x 5 cm mit deckel  
Polycarbonate sopper plate 19 x 5 cm with lid  
Prato fundo policarbonato 19 x 5 cm com tampa

Ref	€	ml	Pack
66934	8,10	450	1 Conjunto · Set
66934C	4,60	450	1 Plato · Plate
66939	3,50	-	1 Tapa · Lid



### Bol Policarbonato 13x6,5 cms. con tapa

Bol polycarbonate 13 x 6,5 cms. avec couvercle  
Schüssel, Polycarbonat 13 x 6,5 cms. mit deckel  
Polycarbonate bowl 13 x 6,5 cms with lid  
Tijela policarbonato 13 x 6,5 cms com tampa

Ref	€	ml	Pack
66937	5,20	450	1 Conjunto · Set
66937C	4,10	450	1 Bol · Bowl
66938	1,10	-	1 Tapa · Lid



### Bol doble pared Policarbonato con tapa

Bol isotherme Polycarb. a/couvercle  
Polycarbonat Schüssel, Isothermal mit Deckel  
Double wall Polycarbonate bowl w/lid  
Tijela parede dupla policarbonato com tampa

Ref	€	Ø (cm)	ml	Pack
66948	11,10	12,5x7	500	1 Conjunto · Set
66948S	10,00	12,5x7	500	1 Bol · Bowl
66938	1,10	12,5	-	1 Tapa · Lid



### Taza doble pared Policarbonato con tapa

Coupelle dessert isotherme Polycarb. a/couvercle  
Polycarbonat Kaffee Tasse Isoliert! mit Deckel  
Double wall Polycarbonate mug w/lid  
Chávena parede duplo policarbonato com tampa

Ref	€	Ø (cm)	ml	Pack
66949	12,00	8,5x7	250	1 Conjunto · Set
66949S	9,00	8,5x7	250	1 Taza · Cup
66949T	1,00	8,5	-	1 Tapa · Lid



### Taza desayuno Policarbonato con tapa

Coupelle dessert polycarbonate a/couvercle  
Prühstücksschale, Polycarbonat mit Deckel  
Polycarbonate breakfast cup w/lid  
Chávena pequeno-almoço policarbonato com tampa

Ref	€	Ø (cm)	ml	Pack
66936	4,10	9x7	300	1 Conjunto · Set
66936C	3,20	9x7	300	1 Taza · Cup
66936T	0,90	9	-	1 Tapa · Lid



**Plato desayuno Policarbonato Ø18x2,5 cms.**

Assiette dessert polycarbonate Ø18 x 2,5 cms.  
Frühstücksteller, Polycarbonat Ø18 x 2,5 cms.  
Polycarbonate breakfast plate Ø18 x 2,5 cms  
Prato de pequeno-almoço polycarbonato Ø18 x 2,5 cms

Ref	€	Pack
66935	3,90	1

**A**



**B**



**Vaso Policarbonato**

Verre polycarbonate  
Glas, Polycarbonat  
Polycarbonate glass  
Copo polycarbonato

	Ref	€	Ø (cm)	ml	Pack
<b>A</b>	66947	1,70	7x10	250	1
<b>B</b>	66932	2,40	8,3x9,5	300	1



**Bol cuadrado Policarbonato con tapa**

Bac carre en Polycarbonate avec couvercle  
Polycarbonat Behälter, Vierecking mit Deckel  
Square Polycarbonate bowl with lid  
Caixa quadrada polycarbonato com tampa

Ref	€	cm	ml	Pack	
66972	6,30	12x12x4,5	400	1	Conjunto · Set
66972C	4,10	12x12x4,5	400	1	Bol · Bowl
66975	2,20	12x12	-	1	Tapa · Lid



**Bol rectangular Policarbonato con tapa**

Bac rectangulière en Polycarbonate avec couvercle  
Polycarbonat Behälter, Rechtecking mit Deckel  
Rectangular Polycarbonate bowl with lid  
Caixa qrectangular polycarbonato com tampa

	Ref	€	cm	ml	Pack	
	66974	8,30	17x12	600	1	Conjunto · Set
	66974C	5,20	17x12	600	1	Bol · Bowl
	66977	3,10	17x12	-	1	Tapa · Lid



125°C Max.

**Tapa cubreplatos redondo Policarbonato**

Couvercle pour assiettes Polycarbonate  
Polycarbonat Teller-Abdeckung  
Polycarbonate round plat cover  
Tampa cobre-pratos redonda polycarbonato

Ref	€	Ø (cm)	Pack
66950	9,60	25x7	1

**Jarra Policarbonato**

Pot verser Polycarbonate  
Mass, Polycarbonat  
Polycarbonate jug  
Jarra polycarbonato



	Ref	€	L	Pack	
	66945	9,30	1,00	1	Conjunto · Set
	66945S	7,20	1,00	1	Jarra · Jug
	66945T	2,10	-	1	Tapa · Lid



**A**



**B**

**Bandeja autoservicio**

Plateau self-service  
Selbstbedienung Tablet  
Self-service tray  
Bandeja auto-serviço

	Ref	€	cm	Pack	
<b>A</b>	66952	15,20	33x33	1	Polycarbonate
<b>B</b>	66951	9,20	33x33	1	Polypropylene

**Cierre portafichas hermético**

Porte fiche  
Halterung für Inhaltverzeichnis  
Index card fasterner  
Fecho para bandejas isotérmicas



	Ref	€	Pack
	66956	2,20	1



**Bandeja servicio Polipropileno**

Plateau rectangulaire en Polypropylène  
Tablet Polypropylen, rechtecking  
Polypropylene rectangular tray  
Bandeja de servir polipropileno

Ref	€	cm	Pack
66953	13,70	53x37	1

**Carro portabandejas 20 unidades**

Chariot 20 plateaux  
Wagen für Schale/Tablett (20)  
Isothermal tray trolley 20 unit.  
Carro porta-bandejas 20 unidades

Ref	€	cm	Pack
66931	2.637,00	90x62x148	1





## Estanterías

Las estanterías modulares LACOR no precisan para su montaje/desmontaje de herramienta alguna, son fáciles de montar, robustas y ligeras. Construidas en materiales de alta calidad garantizan una larga duración, además de adecuarse al uso alimenticio en cámaras refrigeradas. La construcción modular permite al cliente adecuarse a la longitud y espacios disponibles, pudiendo ampliar y modificar la distribución en cualquier momento. Diseñadas para poder emplear cubetas GASTRONORM 2/1, 1/1 y 2/3, con dos anchuras de fondo disponibles, 560 mm y 385 mm La distribución de los estantes permite el máximo aprovechamiento de la altura disponible, con un máximo de 11 estantes en altura 1750 mm y 12 estantes en altura de 2000 mm, con un peso máximo aproximado por estantería de 1.200 Kg. Con una altura útil mínima de 100 mm es especialmente recomendada para el almacenaje de medicamentos, artículos de ferretería o alimentos en conserva. Las distintas alturas de los estantes y su fácil montaje/desmontaje, permite que las distancias entre estantes puedan variarse a razón de 150 mm adicionales a los 100 mm iniciales (100mm/250mm/400mm/550mm)

Les étagères modulables LACOR ne nécessitent aucun outil pour leur montage/démontage. Elles sont faciles à monter, robustes et légères. Elles sont construites dans des matériaux d'une grande qualité qui garantissent une longue durée de vie, et s'adaptent à une utilisation alimentaire dans les chambres froides. La construction modulable permet au client de les adapter à la longueur et aux espaces disponibles, avec la possibilité d'agrandir ou de modifier la distribution à tout moment. Conçues pour l'emploi de bacs GASTRONORM 2/1, 1/1 et 2/3, avec deux largeurs de fond disponibles, 560 mm et 385 mm L'agencement des étagères permet de profiter au maximum de la hauteur disponible, avec un nombre limite de 11 étagères en hauteur de 1750 mm et de 12 étagères en hauteur de 2000 mm, pour un poids maximum d'environ 1.200 Kg par étagère. Avec une hauteur utile minimale de 100 mm, elle est spécialement conseillée pour stocker des médicaments, des articles de quincaillerie ou des aliments en conserve. Les différentes hauteurs des étagères et leur facilité de montage/démontage permettent de varier la distance entre étagères de 150 mm supplémentaires par rapport aux 100 mm d'origine (100mm/250mm/400mm/550mm)

Für den Auf-/Abbau der Modulregale LACOR ist keinerlei Werkzeug erforderlich, sie sind einfach zu montieren, robust und leicht. Dank ihrer Fertigung aus hochwertigen Werkstoffen besitzen sie eine garantiert lange Lebensdauer und eignen sich für die Aufbewahrung von Lebensmitteln in Kühlräumen. Der modulare Aufbau ermöglicht es dem Kunden, sich an die zur Verfügung stehenden Längen- und Raummaße anzupassen, wobei sich die Anordnung jederzeit erweitern und ändern lässt. Ausgelegt für den Einsatz von Behältern GASTRONORM 2/1, 1/1 und 2/3, verfügbar in zwei Tiefen (560 mm und 385 mm). Die Anordnung der Regalfächer ermöglicht die größtmögliche Nutzung der verfügbaren Höhe. Bis zu 11 Fächern bei einer Höhe von 1750 mm und 12 Fächern bei einer Höhe von 2000 mm Höchstgewicht pro Regalfach ca. 1200 kg. Bei einer Mindestnutzhöhe von 100 mm eignet sich das Regal besonders für die Aufbewahrung von Medikamenten, Eisenwarenartikeln oder Lebensmittelkonserven. Die unterschiedlichen Höhen der Regalfächer und deren einfache Montage/Demontage bieten die Möglichkeit, die Abstände zwischen den Fächern nach dem anfänglichen Maß von 100 mm um jeweils 150 mm zu versetzen (100mm/250mm/400mm/550mm)

No tools are required in the assembly/disassembly of LACOR modular shelving; they are easy to assemble, robust and light. Built in top-quality material, they are guaranteed to be long-lasting, and also apt for storing food in refrigerators. Their modular construction allows the client to fit them lengthwise into the available space, being able to expand and modify their distribution at anytime. Designed for use with GASTRONORM 2/1, 1/1 and 2/3 trays, with two available depths, 560mm and 385mm The shelves' distribution allows for maximum use of available height, with a maximum height of 11 shelves at 1750mm and 12 shelves 2000mm, with an approximate maximum weight of 1,200kg per shelf. With a minimum height of 100mm, it's especially recommended for storing medicine, tools or canned foods. The different shelf heights and easy assembly/disassembly make it so the distances between shelves can vary by 150mm from the initial 100mm (100mm/250mm/400mm/550mm)

Prateleiras modulares LACOR não exigida para a montagem / desmontagem ferramentas alguns, são fáceis de instalar, robustas e leves. Construído em materiais de alta qualidade para assegurar a longo prazo, também adaptados para uso alimentar em refrigeração. A construção modular permite ao cliente adequarse a la longitud e espaços disponíveis, pode-se estender e mudança la distribuição a qualquer momento.

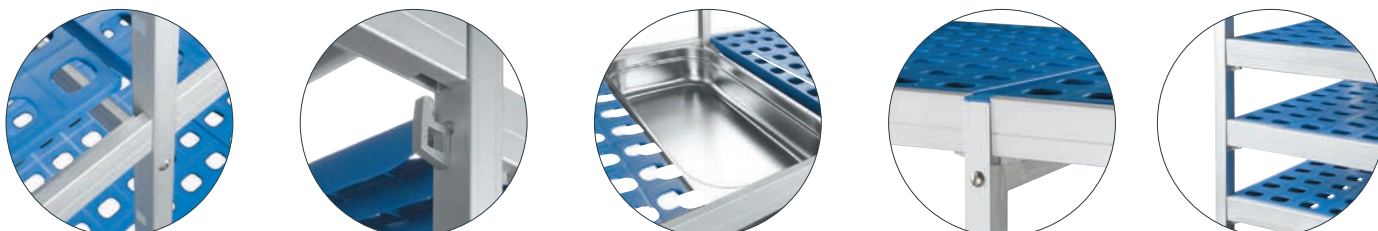

**Long**    **Max**  
 < 1 mt    120 Kg  
 > 1 mt    100 Kg

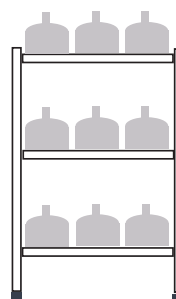

**Capacidad por estante**  
 Capacité par plateau  
 Kapazität pro Regal  
 Capacity per shelf  
 Capacidade por prateleira

**Distribuir el peso uniformemente**  
 Distribuer uniformément le poids  
 Verteilen das Gewicht gleichmäßig  
 Distributing the weight evenly  
 Distribua o peso uniformemente

**Fondo**  
 385 mm

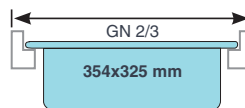

**Fondo**  
 560 mm

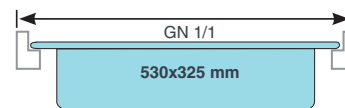

## Instrucciones montaje

Las estanterías LACOR no precisan de herramienta alguna para su montaje o desmontaje, siga estas instrucciones para poder realizar el montaje de una estantería simple. En caso de precisar cualquier aclaración o información adicional no dude en ponerse en contacto con su suministrador o visite nuestra página web.

- 1.- Extraiga todos los componentes de su embalaje original, no se deshaga de éste hasta comprobar que el artículo se encuentra completo. Coloque todos los componentes en el suelo.
- 2.- Disponga de un espacio libre, ampliamente superior a las dimensiones de la estantería a montar.
- 3.- Tome un soporte lateral extendido en el suelo, introduzca 2 ganchos en los orificios más bajos que vaya a emplear, tal y como muestra la Figura 1. Apoye este soporte lateral contra la pared.
- 4.- Tome el otro soporte lateral, e introduzca los ganchos en los mismos orificios. Coloque ahora los 2 largueros de la parte inferior, Figura 2.
- 5.- Coloque de pie este soporte lateral y aproxímese al soporte lateral apoyado contra la pared, introduzca los largueros en los ganchos de éste, la estantería quedará estabilizada, Figura 3. Asegúrese de que los largueros han sido correctamente colocados.
- 6.- Ahora puede seleccionar las diferentes alturas a las cuales colocará los ganchos y largueros de los estantes, Figura 4.
- 7.- Antes de colocar las parrillas plásticas, asegúrese de que todos los largueros se encuentran correctamente colocados.
- 8.- Montaje guía ángulo;
  - a.- Retire todas las parrillas plásticas y extraiga uno de los largueros de la estantería.
  - b.- Introduzca 2 ganchos de ángulo en la barra ángulo tal y como muestra la figura Figura 6 y 7.  
NOTA: Deberá emplear tantas barras ángulo como estantes disponga, Figura 5.
  - c.- Introduzca el larguero por la barra ángulo con los ganchos laterales, según la Figura 8.
  - d.- Ahora coloque el larguero con las barras ángulo en su anterior ubicación. Realice el mismo proceso con todos los largueros de uno de los laterales.
  - e.- Una vez terminado, asegúrese de colocar todas las barras ángulo contra el mismo extremo, ahora realice el montaje de los 2 largueros de la parte inferior, Figura 9.
  - f.- Coloque en el nuevo soporte lateral 2 ganchos a la misma altura que la estantería ya montada.
  - g.- Monte el nuevo soporte lateral a los largueros que forman el ángulo, Figura 9, asegúrese de introducirlos correctamente.
  - h.- Ahora ya puede montar el resto de largueros hasta finalizar el montaje.
  - i.- Antes de colocar las parrillas plásticas, asegúrese de que todos los largueros se encuentran correctamente colocados  
NOTA: Las patas pueden regularse en altura 1 cm para absorber irregularidades del suelo, emplee una llave inglesa o fija de 17 mm

## Mounting instructions

The LACOR shelves do not need any tool whatsoever to be assembled or dismantled. Follow these instructions to be able to assemble one single shelf. If you need any further explanation or information, do not hesitate to contact your supplier or visit our website.

- 1.- Take all the components out of their original wrapping. Do not throw the wrapping away until you have checked that the article is complete. Place all the components on the floor.
- 2.- Make a space available that is much larger than the shelf to be assembled.
- 3.- Take a side support lying on the floor and put two hooks into the lowest holes you are going to use, as shown in Figure 1. Lean this support against the wall.
- 4.- Take the other side support and put the hooks into the same holes. Now place the 2 lower rods, Figure 2.
- 5.- Stand this side support up and bring it next to the side support leaning against the wall. Put the rod lengths into its hooks. The shelf will remain stabilized, Figure 3. Make sure the rod lengths have been properly placed.
- 6.- Now you can select the different heights at which you will place the hooks and the shelf rod lengths, Figure 4.
- 7.- Before placing the plastic racks, make sure that all the rods are properly in place.
- 8.- Assembly of angle guide rail:
  - a.- Remove all the plastic racks and take out one of the shelf rod lengths.
  - b.- Put 2 angle hooks into the angle bar as shown in Figure 6 and Figure 7.  
NOTE: You must use as many angle bars as the number of shelves you have, Figure 5.
  - c.- Put the rod length through the angle bar with the side hooks, according to Figure 8.
  - d.- Now place the rod length with the angle bars in its previous place. Follow the same process with all the rod lengths of one of the sides.
  - e.- Once finished, make sure you place all the angle bars against the same end. Now assemble the 2 lower rod lengths, Figure 9.
  - f.- Place 2 hooks on the new side support at the same height as the shelf assembled.
  - g.- Mount the new side support onto the rod lengths that form the angle, Figure 9. Make sure you introduce them properly.
  - h.- Now you can assemble the rest of the rod lengths until you finish the assembly.
  - i.- Before placing the plastic racks, make sure that all the rod lengths are properly placed.  
NOTE: The legs can be adjusted by 1 cm in height to absorb uneven-nesses in the floor. Use an adjustable or 17 mm fixed spanner.

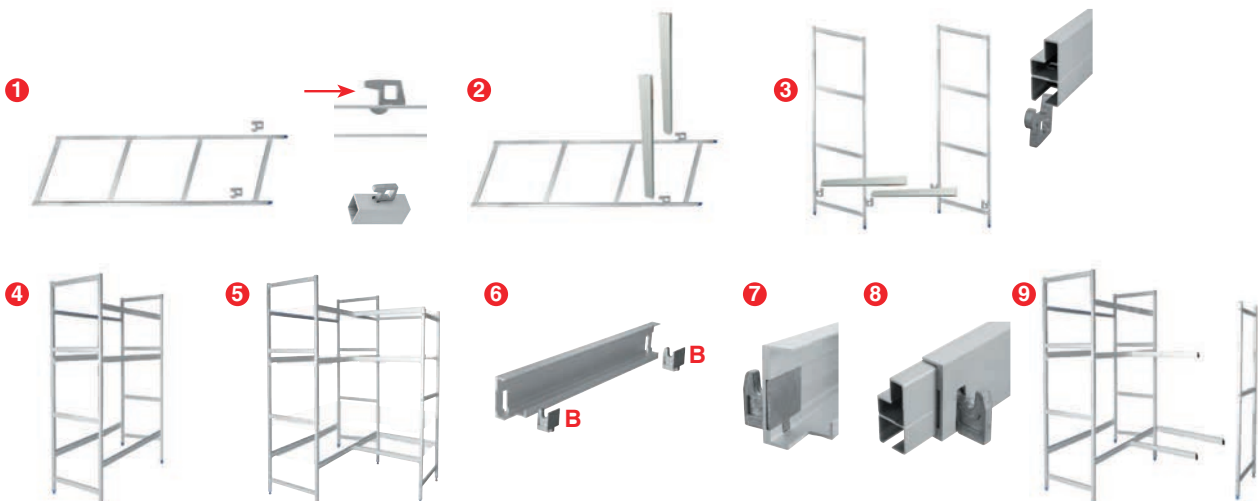

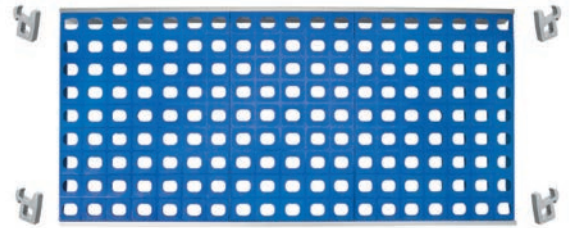
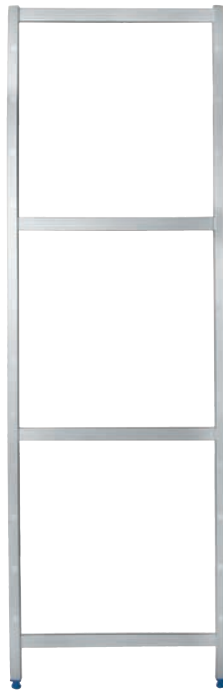

**Soporte lateral**

Support latérale  
Seitenständer  
Lateral support  
Suporte latera

385 mm (GN 2/3)			560 mm (GN 1/1)		
Fondo / Width			Fondo / Width		
Ref	€	h (mm)	Ref	€	
56302	25,30	250	57302	28,40	
56317	69,30	1750	57317	75,00	
56320	81,00	2000	57320	86,60	

**Estante completo**

Étahère complète  
Komplete regal  
Shelf set  
Prateleira completo

385 mm (GN 2/3)			560 mm (GN 1/1)		
Fondo / Width			Fondo / Width		
Ref	€	L (mm)	Ref	€	Pack
56007	36,40	710	57007	42,80	1
56008	38,60	820	57008	45,20	1
56009	42,80	930	57009	49,10	1
56010	49,10	1035	57010	58,20	1
56011	53,00	1145	57011	62,20	1
56012	56,40	1255	57012	66,20	1
56013	58,20	1365	57013	70,00	1
56014	66,20	1470	57014	77,20	1
56015	68,00	1580	57015	81,70	1

**Set ángulo 90°**

Jeu angle 90°  
Eckesatz 90°  
90° corner set  
Conjunto ângulo 90°



Ref	€	L (mm)	Pack
56330	12,10	385	1
57330	15,30	560	1



**Rueda para estantería**

Roue pour étagère  
Rad für Regal  
Shelf wheel  
Roda para prateleira

	Ref	€	Pack
<b>A</b>	56522	35,40	1
<b>B</b>	56523	48,00	1

## Repuestos

Pièces détachées · Ersatzteile · Spares · Sobresselentes

### Barra soporte lateral

Barre support latérale  
Seitenständer stange  
Lateral support bar  
Barra suporte lateral

Ref	€	h (mm)	Pack
56502	7,20	250	1
56517	25,10	1750	1
56520	27,60	2000	1

### Travesaño · Crossbar



Barra · Bar

### Travesaño soporte lateral

Longeron support latérale  
Seitenständer traverse  
Lateral support crossbar  
Travesaño suporte lateral

Ref	€	L (mm)	Pack
56321	4,30	385	1
57321	6,30	560	1

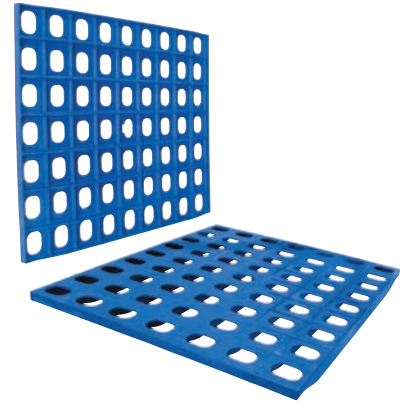

### Parrilla Polietileno

Clayete en polyéthilène  
Polyethylene stab  
Polyethylene rack  
Grelha polietileno

Ref	€	mm	Pack
56325	5,60	353x325	1
56435	6,50	353x425	1
57325	8,60	530x325	1
57435	10,70	530x435	1

### Travesaño

Longeron  
Traverse  
Crossbar  
Travesano

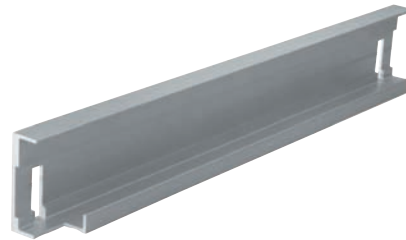

Ref	€	L (mm)	Pack
56507	11,10	654	1
56508	11,80	766	1
56509	13,40	876	1
56510	14,60	981	1
56511	15,90	1091	1
56512	17,10	1201	1
56513	18,00	1311	1
56514	19,30	1416	1
56515	20,10	1526	1

### Set ángulo 90°

Jeu angle 90°  
Eckesatz 90°  
90° corner set  
Conjunto ângulo 90°

Ref	€	L (mm)	Pack
56322	11,30	385	1
57322	14,40	560	1

### Jgo. 4 ganchos travesaño

Jeu 4 crochet pour longeron  
4 Satz Haken für traverse  
4 pcs. crossbar hooks  
Jogo 4 ganchos travesano

Ref	€	Pack
56524	2,50	1

### Jgo. 4 ganchos ángulo

Jeu 4 crochet pour l'angle  
4 Satz Haken für ecke  
4 pcs. set corner hooks  
Jogo 4 ganchos ângulo

Ref	€	Pack
56527	2,00	1

### Jgo. 6 tornillos

Jeu 6 vis en Inox  
6 Satz schrauben  
6 pcs. set screws  
Jogo 6 parafusos

Ref	€	Pack
56526	1,80	1

### Jgo. 2 pie nivelación

Jeu 2 pied nivellement  
2 Satz niveau füsse  
26 pcs. set level foot  
2 jogo pé nivelamento

Ref	€	Pack
56525	3,80	1





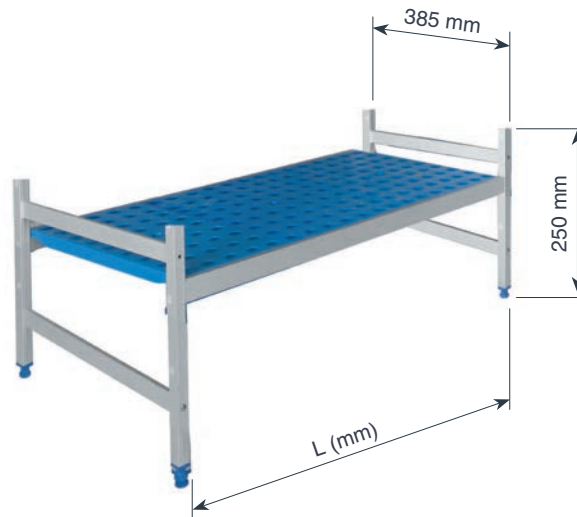

**Fondo** · Width: 385 mm  
**Altura** · Height: 250 mm

**Bancada completa**

Banc complet  
Vollbank  
Full bench  
Banco completo

**1 Estante · Shelf**

L (mm)	Ref	€	Desglose / Breakdown
710	55400	87,90	56302 x 2 / 56007 x 1
822	55401	89,90	56302 x 2 / 56008 x 1
932	55402	93,70	56302 x 2 / 56009 x 1
1037	55403	99,70	56302 x 2 / 56010 x 1
1147	55404	103,60	56302 x 2 / 56011 x 1
1257	55405	107,00	56302 x 2 / 56012 x 1
1367	55406	108,80	56302 x 2 / 56013 x 1
1472	55407	116,70	56302 x 2 / 56014 x 1
1582	55408	118,60	56302 x 2 / 56015 x 1

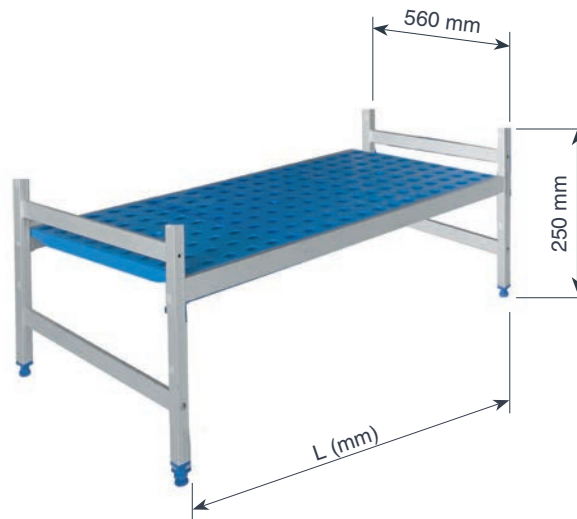

**Fondo** · Width: 560 mm  
**Altura** · Height: 250 mm

**Bancada completa**

Banc complet  
Vollbank  
Full bench  
Banco completo

**1 Estante · Shelf**

L (mm)	Ref	€	Desglose / Breakdown
710	55700	100,00	57302 x 2 / 57007 x 1
822	55701	102,00	57302 x 2 / 57008 x 1
932	55702	105,90	57302 x 2 / 57009 x 1
1037	55703	115,10	57302 x 2 / 57010 x 1
1147	55704	119,00	57302 x 2 / 57011 x 1
1257	55705	122,90	57302 x 2 / 57012 x 1
1367	55706	126,70	57302 x 2 / 57013 x 1
1472	55707	134,60	57302 x 2 / 57014 x 1
1582	55708	138,30	57302 x 2 / 57015 x 1



Fondo · Width: 385 mm  
Altura · Height: 1.750 mm

**Estantería completa**  
Rayonnage complet  
Volle Regale  
Full shelving  
Estantes completa

SIMPLE

DOBLE · DOUBLE

TRIPLE

**3 Estantes · Shelf**

L (mm)	Ref	€	Desglose · Breakdown
710	55409	250,50	56317 x 2 + 56007 x 3
822	55410	256,60	56317 x 2 + 56008 x 3
932	55411	268,30	56317 x 2 + 56009 x 3
1037	55412	285,90	56317 x 2 + 56010 x 3
1147	55413	296,80	56317 x 2 + 56011 x 3
1257	55414	307,70	56317 x 2 + 56012 x 3
1367	55415	312,90	56317 x 2 + 56013 x 3
1472	55416	337,00	56317 x 2 + 56014 x 3
1582	55417	341,90	56317 x 2 + 56015 x 3

**4 Estantes · Shelf**

Ref	€	Desglose · Breakdown
55446	287,10	56317 x 2 + 56007 x 4
55447	296,00	56317 x 2 + 56008 x 4
55448	310,80	56317 x 2 + 56009 x 4
55449	334,40	56317 x 2 + 56010 x 4
55450	350,40	56317 x 2 + 56011 x 4
55451	364,10	56317 x 2 + 56012 x 4
55452	371,80	56317 x 2 + 56013 x 4
55453	403,10	56317 x 2 + 56014 x 4
55454	410,90	56317 x 2 + 56015 x 4

**5 Estantes · Shelf**

Ref	€	Desglose · Breakdown
55483	324,70	56317 x 2 + 56007 x 5
55484	334,40	56317 x 2 + 56008 x 5
55485	354,60	56317 x 2 + 56009 x 5
55486	384,10	56317 x 2 + 56010 x 5
55487	403,90	56317 x 2 + 56011 x 5
55488	420,50	56317 x 2 + 56012 x 5
55489	421,70	56317 x 2 + 56013 x 5
55490	460,00	56317 x 2 + 56014 x 5
55491	469,50	56317 x 2 + 56015 x 5

L (mm)	Ref	€	Desglose · Breakdown
1719	55418	467,20	56317 x 3 + 56007 x 3 + 56010 x 3
1829	55419	479,00	56317 x 3 + 56007 x 3 + 56011 x 3
1939	55420	489,00	56317 x 3 + 56007 x 3 + 56012 x 3
2046	55421	502,60	56317 x 2 + 56010 x 6
2154	55422	518,30	56317 x 3 + 56007 x 3 + 56014 x 3
2264	55423	524,10	56317 x 3 + 56007 x 3 + 56015 x 3
2376	55424	530,10	56317 x 3 + 56010 x 3 + 56013 x 3
2481	55425	553,60	56317 x 3 + 56010 x 3 + 56014 x 3
2591	55426	559,50	56317 x 3 + 56010 x 3 + 56015 x 3
2701	55427	571,30	56317 x 3 + 56011 x 3 + 56015 x 3
2811	55428	581,30	56317 x 3 + 56013 x 3 + 56014 x 3
2916	55429	604,30	56317 x 2 + 56014 x 6
3026	55430	609,80	56317 x 3 + 56014 x 3 + 56015 x 3
3136	55431	616,30	56317 x 3 + 56015 x 6

Ref	€	Desglose · Breakdown
55455	553,50	56317 x 3 + 56007 x 4 + 56010 x 4
55456	569,00	56317 x 3 + 56007 x 4 + 56011 x 4
55457	581,90	56317 x 3 + 56007 x 4 + 56012 x 4
55458	600,60	56317 x 3 + 56010 x 8
55459	621,70	56317 x 3 + 56007 x 4 + 56014 x 4
55460	629,00	56317 x 3 + 56007 x 4 + 56015 x 4
55461	637,50	56317 x 3 + 56010 x 4 + 56013 x 4
55462	668,80	56317 x 3 + 56010 x 4 + 56014 x 4
55463	676,20	56317 x 3 + 56010 x 4 + 56015 x 4
55464	692,40	56317 x 3 + 56011 x 4 + 56015 x 4
55465	705,70	56317 x 3 + 56013 x 4 + 56014 x 4
55466	737,00	56317 x 3 + 56014 x 8
55467	744,60	56317 x 3 + 56014 x 4 + 56015 x 4
55468	752,50	56317 x 3 + 56015 x 8

Ref	€	Desglose · Breakdown
55492	639,80	56317 x 3 + 56007 x 5 + 56010 x 5
55493	659,70	56317 x 3 + 56007 x 5 + 56011 x 5
55494	676,30	56317 x 3 + 56007 x 5 + 56012 x 5
55495	698,80	56317 x 3 + 56010 x 10
55496	725,00	56317 x 3 + 56007 x 5 + 56014 x 5
55497	734,70	56317 x 3 + 56007 x 5 + 56015 x 5
55498	744,90	56317 x 3 + 56010 x 5 + 56013 x 5
55499	784,00	56317 x 3 + 56010 x 5 + 56014 x 5
55500	793,70	56317 x 3 + 56010 x 5 + 56015 x 5
55501	813,40	56317 x 3 + 56011 x 5 + 56015 x 5
55502	830,10	56317 x 3 + 56013 x 5 + 56014 x 5
55503	869,10	56317 x 3 + 56014 x 10
55504	878,80	56317 x 3 + 56014 x 5 + 56015 x 5
55505	888,50	56317 x 3 + 56015 x 10

L (mm)	Ref	€	Desglose · Breakdown
3275	55432	740,80	56317 x 4 + 56010 x 6 + 56012 x 3
3385	55433	746,70	56317 x 4 + 56010 x 6 + 56013 x 3
3490	55434	770,20	56317 x 4 + 56010 x 6 + 56014 x 3
3598	55435	785,90	56317 x 4 + 56007 x 3 + 56014 x 6
3710	55436	794,00	56317 x 4 + 56011 x 6 + 56014 x 3
3818	55437	797,40	56317 x 4 + 56007 x 3 + 56015 x 6
3925	55438	821,30	56317 x 4 + 56010 x 3 + 56014 x 6
4035	55439	833,10	56317 x 4 + 56011 x 3 + 56014 x 6
4145	55440	836,10	56317 x 4 + 56010 x 3 + 56015 x 6
4255	55441	844,70	56317 x 4 + 56011 x 3 + 56015 x 6
4360	55442	872,40	56317 x 4 + 56014 x 9
4470	55443	878,20	56317 x 4 + 56014 x 6 + 56015 x 3
4580	55444	883,90	56317 x 4 + 56014 x 3 + 56015 x 6
4690	55445	889,70	56317 x 4 + 56015 x 9

Ref	€	Desglose · Breakdown
55469	895,50	56317 x 4 + 56010 x 8 + 56012 x 4
55470	903,20	56317 x 4 + 56010 x 8 + 56013 x 4
55471	934,50	56317 x 4 + 56010 x 8 + 56014 x 4
55472	955,40	56317 x 4 + 56007 x 4 + 56014 x 8
55473	966,10	56317 x 4 + 56011 x 8 + 56014 x 4
55474	970,90	56317 x 4 + 56007 x 4 + 56015 x 8
55475	1.002,70	56317 x 4 + 56010 x 4 + 56014 x 8
55476	1.023,40	56317 x 4 + 56011 x 4 + 56014 x 8
55477	1.028,60	56317 x 4 + 56010 x 4 + 56015 x 8
55478	1.033,90	56317 x 4 + 56011 x 4 + 56015 x 8
55479	1.070,80	56317 x 4 + 56014 x 12
55480	1.078,40	56317 x 4 + 56014 x 8 + 56015 x 4
55481	1.086,20	56317 x 4 + 56014 x 4 + 56015 x 8
55482	1.093,80	56317 x 4 + 56015 x 12

Ref	€	Desglose · Breakdown
55506	1.050,00	56317 x 4 + 56010 x 10 + 56012 x 5
55507	1.059,70	56317 x 4 + 56010 x 10 + 56013 x 5
55508	1.098,70	56317 x 4 + 56010 x 10 + 56014 x 5
55509	1.125,00	56317 x 4 + 56007 x 5 + 56014 x 10
55510	1.138,40	56317 x 4 + 56011 x 10 + 56014 x 5
55511	1.144,20	56317 x 4 + 56007 x 5 + 56015 x 10
55512	1.183,90	56317 x 4 + 56010 x 5 + 56014 x 10
55513	1.203,70	56317 x 4 + 56011 x 5 + 56014 x 10
55514	1.210,90	56317 x 4 + 56010 x 5 + 56015 x 10
55515	1.223,00	56317 x 4 + 56011 x 5 + 56015 x 10
55516	1.269,10	56317 x 4 + 56014 x 15
55517	1.278,80	56317 x 4 + 56014 x 10 + 56015 x 5
55518	1.288,50	56317 x 4 + 56014 x 5 + 56015 x 10
55519	1.298,10	56317 x 4 + 56015 x 15

Transporte-Estanterías  
transport - Shelves

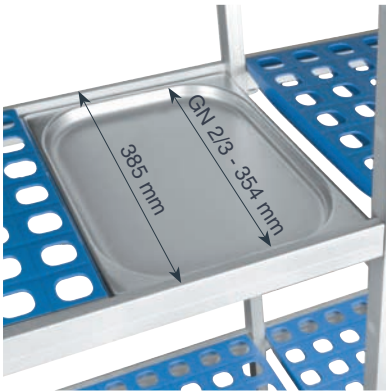

Fondo · Width: 385 mm  
Altura · Height: 2.000 mm

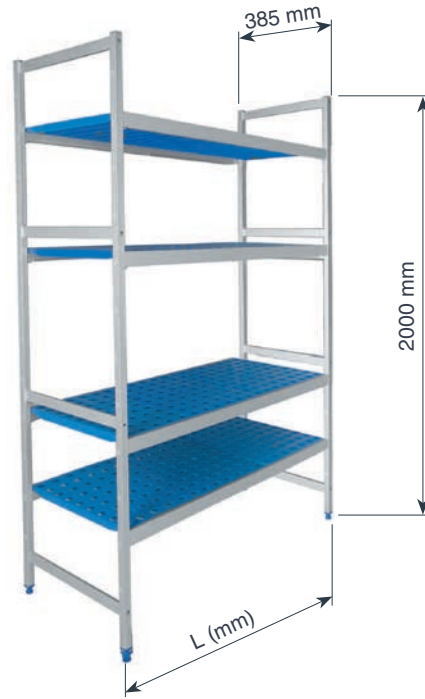

**Estantería completa**  
Rayonnage complet  
Volle Regale  
Full shelving  
Estantes completa

SIMPLE

DOBLE · DOUBLE

TRIPLE

**3 Estantes · Shelf**

**4 Estantes · Shelf**

**5 Estantes · Shelf**

L (mm)	Ref	€	Desglose · Breakdown
710	55520	273,80	56320 x 2 + 56007 x 3
822	55521	279,70	56320 x 2 + 56008 x 3
932	55522	290,40	56320 x 2 + 56009 x 3
1037	55523	308,50	56320 x 2 + 56010 x 3
1147	55524	321,00	56320 x 2 + 56011 x 3
1257	55525	331,00	56320 x 2 + 56012 x 3
1367	55526	336,70	56320 x 2 + 56013 x 3
1472	55527	360,20	56320 x 2 + 56014 x 3
1582	55528	365,90	56320 x 2 + 56015 x 3

Ref	€	Desglose · Breakdown
55557	311,00	56320 x 2 + 56007 x 4
55558	319,10	56320 x 2 + 56008 x 4
55559	334,60	56320 x 2 + 56009 x 4
55560	358,10	56320 x 2 + 56010 x 4
55561	374,00	56320 x 2 + 56011 x 4
55562	387,20	56320 x 2 + 56012 x 4
55563	395,00	56320 x 2 + 56013 x 4
55564	426,30	56320 x 2 + 56014 x 4
55565	433,90	56320 x 2 + 56015 x 4

Ref	€	Desglose · Breakdown
55594	348,20	56320 x 2 + 56007 x 5
55595	358,40	56320 x 2 + 56008 x 5
55596	377,80	56320 x 2 + 56009 x 5
55597	407,20	56320 x 2 + 56010 x 5
55598	427,10	56320 x 2 + 56011 x 5
55599	443,60	56320 x 2 + 56012 x 5
55600	453,30	56320 x 2 + 56013 x 5
55601	492,50	56320 x 2 + 56014 x 5
55602	502,10	56320 x 2 + 56015 x 5

L (mm)	Ref	€	Desglose · Breakdown
1719	55529	501,70	56320 x 3 + 56007 x 3 + 56010 x 3
1829	55530	513,80	56320 x 3 + 56007 x 3 + 56011 x 3
1939	55531	523,80	56320 x 3 + 56007 x 3 + 56012 x 3
2046	55532	537,10	56320 x 2 + 56010 x 6
2154	55533	552,90	56320 x 3 + 56007 x 3 + 56014 x 3
2264	55534	558,70	56320 x 3 + 56007 x 3 + 56015 x 3
2376	55535	564,90	56320 x 3 + 56010 x 3 + 56013 x 3
2481	55536	588,30	56320 x 3 + 56010 x 3 + 56014 x 3
2591	55537	594,00	56320 x 3 + 56010 x 3 + 56015 x 3
2701	55538	606,10	56320 x 3 + 56011 x 3 + 56015 x 3
2811	55539	615,10	56320 x 3 + 56013 x 3 + 56014 x 3
2916	55540	638,70	56320 x 2 + 56014 x 6
3026	55541	645,30	56320 x 3 + 56014 x 3 + 56015 x 3
3136	55542	651,00	56320 x 3 + 56015 x 6

Ref	€	Desglose · Breakdown
55566	588,20	56320 x 3 + 56007 x 4 + 56010 x 4
55567	603,30	56320 x 3 + 56007 x 4 + 56011 x 4
55568	617,40	56320 x 3 + 56007 x 4 + 56012 x 4
55569	635,40	56320 x 3 + 56010 x 8
55570	656,40	56320 x 3 + 56007 x 4 + 56014 x 4
55571	663,40	56320 x 3 + 56007 x 4 + 56015 x 4
55572	671,90	56320 x 3 + 56010 x 4 + 56013 x 4
55573	703,50	56320 x 3 + 56010 x 4 + 56014 x 4
55574	711,20	56320 x 3 + 56010 x 4 + 56015 x 4
55575	727,20	56320 x 3 + 56011 x 4 + 56015 x 4
55576	740,30	56320 x 3 + 56013 x 4 + 56014 x 4
55577	771,60	56320 x 3 + 56014 x 8
55578	779,40	56320 x 3 + 56014 x 4 + 56015 x 4
55579	787,00	56320 x 3 + 56015 x 8

Ref	€	Desglose · Breakdown
55603	674,60	56320 x 3 + 56007 x 5 + 56010 x 5
55604	694,30	56320 x 3 + 56007 x 5 + 56011 x 5
55605	711,00	56320 x 3 + 56007 x 5 + 56012 x 5
55606	733,50	56320 x 3 + 56010 x 10
55607	759,80	56320 x 3 + 56007 x 5 + 56014 x 5
55608	769,40	56320 x 3 + 56007 x 5 + 56015 x 5
55609	779,60	56320 x 3 + 56010 x 5 + 56013 x 5
55610	818,70	56320 x 3 + 56010 x 5 + 56014 x 5
55611	828,30	56320 x 3 + 56010 x 5 + 56015 x 5
55612	848,10	56320 x 3 + 56011 x 5 + 56015 x 5
55613	864,80	56320 x 3 + 56013 x 5 + 56014 x 5
55614	903,90	56320 x 3 + 56014 x 10
55615	913,60	56320 x 3 + 56014 x 5 + 56015 x 5
55616	923,10	56320 x 3 + 56015 x 10

L (mm)	Ref	€	Desglose · Breakdown
3275	55543	787,10	56320 x 4 + 56010 x 6 + 56012 x 3
3385	55544	792,90	56320 x 4 + 56010 x 6 + 56013 x 3
3490	55545	816,50	56320 x 4 + 56010 x 6 + 56014 x 3
3598	55546	832,20	56320 x 4 + 56007 x 3 + 56014 x 6
3710	55547	840,30	56320 x 4 + 56011 x 6 + 56014 x 3
3818	55548	843,70	56320 x 4 + 56007 x 3 + 56015 x 6
3925	55549	867,60	56320 x 4 + 56010 x 3 + 56014 x 6
4035	55550	879,40	56320 x 4 + 56011 x 3 + 56014 x 6
4145	55551	879,10	56320 x 4 + 56010 x 3 + 56015 x 6
4255	55552	891,00	56320 x 4 + 56011 x 3 + 56015 x 6
4360	55553	918,70	56320 x 4 + 56014 x 9
4470	55554	924,50	56320 x 4 + 56014 x 6 + 56015 x 3
4580	55555	930,20	56320 x 4 + 56014 x 3 + 56015 x 6
4690	55556	936,10	56320 x 4 + 56015 x 9

Ref	€	Desglose · Breakdown
55580	941,80	56320 x 4 + 56010 x 8 + 56012 x 4
55581	949,50	56320 x 4 + 56010 x 8 + 56013 x 4
55582	980,80	56320 x 4 + 56010 x 8 + 56014 x 4
55583	1.001,70	56320 x 4 + 56007 x 4 + 56014 x 8
55584	1.012,50	56320 x 4 + 56011 x 8 + 56014 x 4
55585	1.017,20	56320 x 4 + 56007 x 4 + 56015 x 8
55586	1.049,00	56320 x 4 + 56010 x 4 + 56014 x 8
55587	1.064,80	56320 x 4 + 56011 x 4 + 56014 x 8
55588	1.064,40	56320 x 4 + 56010 x 4 + 56015 x 8
55589	1.080,20	56320 x 4 + 56011 x 4 + 56015 x 8
55590	1.116,70	56320 x 4 + 56014 x 12
55591	1.124,10	56320 x 4 + 56014 x 8 + 56015 x 4
55592	1.132,50	56320 x 4 + 56014 x 4 + 56015 x 8
55593	1.140,20	56320 x 4 + 56015 x 12

Ref	€	Desglose · Breakdown
55617	1.096,30	56320 x 4 + 56010 x 10 + 56012 x 5
55618	1.106,00	56320 x 4 + 56010 x 10 + 56013 x 5
55619	1.145,10	56320 x 4 + 56010 x 10 + 56014 x 5
55620	1.171,30	56320 x 4 + 56007 x 5 + 56014 x 10
55621	1.184,70	56320 x 4 + 56011 x 10 + 56014 x 5
55622	1.190,50	56320 x 4 + 56007 x 5 + 56015 x 10
55623	1.230,10	56320 x 4 + 56010 x 5 + 56014 x 10
55624	1.250,00	56320 x 4 + 56011 x 5 + 56014 x 10
55625	1.249,50	56320 x 4 + 56010 x 5 + 56015 x 10
55626	1.269,30	56320 x 4 + 56011 x 5 + 56015 x 10
55627	1.315,40	56320 x 4 + 56014 x 15
55628	1.325,10	56320 x 4 + 56014 x 10 + 56015 x 5
55629	1.334,80	56320 x 4 + 56014 x 5 + 56015 x 10
55630	1.344,30	56320 x 4 + 56015 x 15



Fondo · Width: 560 mm  
Altura · Height: 1.750 mm

**Estantería completa**  
Rayonnage complet  
Volle Regale  
Full shelving  
Estantes completa

SIMPLE

DOBLE · DOUBLE

TRIPLE

3 Estantes · Shelf				4 Estantes · Shelf			5 Estantes · Shelf		
L (mm)	Ref	€	Desglose · Breakdown	Ref	€	Desglose · Breakdown	Ref	€	Desglose · Breakdown
710	55709	279,70	57317 x 2 + 57007 x 3	55746	322,50	57317 x 2 + 57007 x 4	55783	366,20	57317 x 2 + 57007 x 5
822	55710	285,60	57317 x 2 + 57008 x 3	55747	330,00	57317 x 2 + 57008 x 4	55784	375,80	57317 x 2 + 57008 x 5
932	55711	296,80	57317 x 2 + 57009 x 3	55748	346,20	57317 x 2 + 57009 x 4	55785	395,70	57317 x 2 + 57009 x 5
1037	55712	324,70	57317 x 2 + 57010 x 3	55749	383,40	57317 x 2 + 57010 x 4	55786	441,80	57317 x 2 + 57010 x 5
1147	55713	337,00	57317 x 2 + 57011 x 3	55750	399,30	57317 x 2 + 57011 x 4	55787	461,50	57317 x 2 + 57011 x 5
1257	55714	348,60	57317 x 2 + 57012 x 3	55751	414,70	57317 x 2 + 57012 x 4	55788	480,80	57317 x 2 + 57012 x 5
1367	55715	360,20	57317 x 2 + 57013 x 3	55752	430,10	57317 x 2 + 57013 x 4	55789	500,10	57317 x 2 + 57013 x 5
1472	55716	383,60	57317 x 2 + 57014 x 3	55753	461,40	57317 x 2 + 57014 x 4	55790	539,30	57317 x 2 + 57014 x 5
1582	55717	395,20	57317 x 2 + 57015 x 3	55754	476,80	57317 x 2 + 57015 x 4	55791	558,20	57317 x 2 + 57015 x 5
1719	55718	529,80	57317 x 3 + 57007 x 3 + 57010 x 3	55755	631,30	57317 x 3 + 57007 x 4 + 57010 x 4	55792	732,80	57317 x 3 + 57007 x 5 + 57010 x 5
1829	55719	541,70	57317 x 3 + 57007 x 3 + 57011 x 3	55756	647,10	57317 x 3 + 57007 x 4 + 57011 x 4	55793	752,70	57317 x 3 + 57007 x 5 + 57011 x 5
1939	55720	552,90	57317 x 3 + 57007 x 3 + 57012 x 3	55757	662,20	57317 x 3 + 57007 x 4 + 57012 x 4	55794	771,80	57317 x 3 + 57007 x 5 + 57012 x 5
2046	55721	574,40	57317 x 3 + 57010 x 6	55758	691,80	57317 x 3 + 57010 x 8	55795	808,20	57317 x 3 + 57010 x 10
2154	55722	588,30	57317 x 3 + 57007 x 3 + 57014 x 3	55759	709,30	57317 x 3 + 57007 x 4 + 57014 x 4	55796	830,30	57317 x 3 + 57007 x 5 + 57014 x 5
2264	55723	599,00	57317 x 3 + 57007 x 3 + 57015 x 3	55760	724,70	57317 x 3 + 57007 x 4 + 57015 x 4	55797	849,60	57317 x 3 + 57007 x 5 + 57015 x 5
2376	55724	610,20	57317 x 3 + 57010 x 3 + 57013 x 3	55761	738,50	57317 x 3 + 57010 x 4 + 57013 x 4	55798	866,80	57317 x 3 + 57010 x 5 + 57013 x 5
2481	55725	633,30	57317 x 3 + 57010 x 3 + 57014 x 3	55762	769,70	57317 x 3 + 57010 x 4 + 57014 x 4	55799	905,90	57317 x 3 + 57010 x 5 + 57014 x 5
2591	55726	645,30	57317 x 3 + 57010 x 3 + 57015 x 3	55763	785,20	57317 x 3 + 57010 x 4 + 57015 x 4	55800	925,10	57317 x 3 + 57010 x 5 + 57015 x 5
2701	55727	656,90	57317 x 3 + 57011 x 3 + 57015 x 3	55764	801,00	57317 x 3 + 57011 x 4 + 57015 x 4	55801	945,00	57317 x 3 + 57011 x 5 + 57015 x 5
2811	55728	668,70	57317 x 3 + 57013 x 3 + 57014 x 3	55765	816,50	57317 x 3 + 57013 x 4 + 57014 x 4	55802	964,20	57317 x 3 + 57013 x 5 + 57014 x 5
2916	55729	692,20	57317 x 3 + 57014 x 6	55766	847,70	57317 x 3 + 57014 x 8	55803	1.003,40	57317 x 3 + 57014 x 10
3026	55730	703,70	57317 x 3 + 57014 x 3 + 57015 x 3	55767	863,20	57317 x 3 + 57014 x 4 + 57015 x 4	55804	1.022,70	57317 x 3 + 57014 x 5 + 57015 x 5
3136	55731	715,30	57317 x 3 + 57015 x 6	55768	878,60	57317 x 3 + 57015 x 8	55805	1.041,90	57317 x 3 + 57015 x 10
3275	55732	848,60	57317 x 4 + 57010 x 6 + 57012 x 3	55769	1.031,30	57317 x 4 + 57010 x 8 + 57012 x 4	55806	1.213,10	57317 x 4 + 57010 x 10 + 57012 x 5
3385	55733	860,20	57317 x 4 + 57010 x 6 + 57013 x 3	55770	1.046,70	57317 x 4 + 57010 x 8 + 57013 x 4	55807	1.232,40	57317 x 4 + 57010 x 10 + 57013 x 5
3490	55734	883,60	57317 x 4 + 57010 x 6 + 57014 x 3	55771	1.078,00	57317 x 4 + 57010 x 8 + 57014 x 4	55808	1.272,00	57317 x 4 + 57010 x 10 + 57014 x 5
3598	55735	896,80	57317 x 4 + 57007 x 3 + 57014 x 6	55772	1.095,70	57317 x 4 + 57007 x 4 + 57014 x 8	55809	1.293,50	57317 x 4 + 57007 x 5 + 57014 x 10
3710	55736	907,40	57317 x 4 + 57011 x 6 + 57014 x 3	55773	1.109,00	57317 x 4 + 57011 x 8 + 57014 x 4	55810	1.311,60	57317 x 4 + 57011 x 10 + 57014 x 5
3818	55737	920,00	57317 x 4 + 57007 x 3 + 57015 x 6	55774	1.126,50	57317 x 4 + 57007 x 4 + 57015 x 8	55811	1.332,00	57317 x 4 + 57007 x 5 + 57015 x 10
3925	55738	942,20	57317 x 4 + 57010 x 3 + 57014 x 6	55775	1.156,10	57317 x 4 + 57010 x 4 + 57014 x 8	55812	1.369,50	57317 x 4 + 57010 x 5 + 57014 x 10
4035	55739	954,00	57317 x 4 + 57011 x 3 + 57014 x 6	55776	1.171,30	57317 x 4 + 57011 x 4 + 57014 x 8	55813	1.388,80	57317 x 4 + 57011 x 5 + 57014 x 10
4145	55740	965,30	57317 x 4 + 57010 x 3 + 57015 x 6	55777	1.186,30	57317 x 4 + 57010 x 4 + 57015 x 8	55814	1.408,50	57317 x 4 + 57010 x 5 + 57015 x 10
4255	55741	977,30	57317 x 4 + 57011 x 3 + 57015 x 6	55778	1.202,40	57317 x 4 + 57011 x 4 + 57015 x 8	55815	1.428,40	57317 x 4 + 57011 x 5 + 57015 x 10
4360	55742	1.000,60	57317 x 4 + 57014 x 9	55779	1.233,40	57317 x 4 + 57014 x 12	55816	1.467,50	57317 x 4 + 57014 x 15
4470	55743	1.012,20	57317 x 4 + 57014 x 6 + 57015 x 3	55780	1.249,50	57317 x 4 + 57014 x 8 + 57015 x 4	55817	1.486,80	57317 x 4 + 57014 x 10 + 57015 x 5
4580	55744	1.023,90	57317 x 4 + 57014 x 3 + 57015 x 6	55781	1.264,50	57317 x 4 + 57014 x 4 + 57015 x 8	55818	1.506,10	57317 x 4 + 57014 x 5 + 57015 x 10
4690	55745	1.035,40	57317 x 4 + 57015 x 9	55782	1.280,30	57317 x 4 + 57015 x 12	55819	1.525,30	57317 x 4 + 57015 x 15



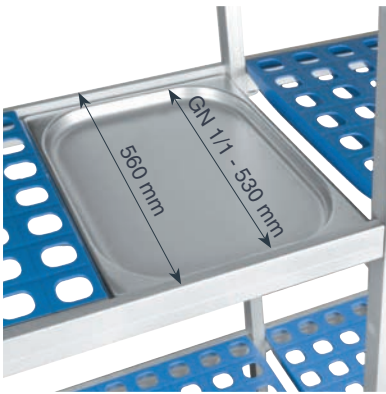

Fondo · Width: 560 mm  
Altura · Height: 2.000 mm

**Estantería completa**  
Rayonnage complet  
Volle Regale  
Full shelving  
Estantes completa

SIMPLE

DOBLE · DOUBLE

TRIPLE

**3 Estantes · Shelf**

**4 Estantes · Shelf**

**5 Estantes · Shelf**

L (mm)	Ref	€	Desglose · Breakdown
710	55820	302,90	57320 x 2 + 57007 x 3
822	55821	308,50	57320 x 2 + 57008 x 3
932	55822	320,70	57320 x 2 + 57009 x 3
1037	55823	348,20	57320 x 2 + 57010 x 3
1147	55824	360,20	57320 x 2 + 57011 x 3
1257	55825	371,70	57320 x 2 + 57012 x 3
1367	55826	383,30	57320 x 2 + 57013 x 3
1472	55827	406,80	57320 x 2 + 57014 x 3
1582	55828	418,30	57320 x 2 + 57015 x 3

Ref	€	Desglose · Breakdown
55857	346,20	57320 x 2 + 57007 x 4
55858	353,80	57320 x 2 + 57008 x 4
55859	369,60	57320 x 2 + 57009 x 4
55860	406,60	57320 x 2 + 57010 x 4
55861	422,40	57320 x 2 + 57011 x 4
55862	437,90	57320 x 2 + 57012 x 4
55863	453,30	57320 x 2 + 57013 x 4
55864	484,60	57320 x 2 + 57014 x 4
55865	500,00	57320 x 2 + 57015 x 4

Ref	€	Desglose · Breakdown
55894	389,30	57320 x 2 + 57007 x 5
55895	399,00	57320 x 2 + 57008 x 5
55896	418,70	57320 x 2 + 57009 x 5
55897	464,80	57320 x 2 + 57010 x 5
55898	484,70	57320 x 2 + 57011 x 5
55899	504,00	57320 x 2 + 57012 x 5
55900	523,30	57320 x 2 + 57013 x 5
55901	561,50	57320 x 2 + 57014 x 5
55902	580,90	57320 x 2 + 57015 x 5

L (mm)	Ref	€	Desglose · Breakdown
1719	55829	563,70	57320 x 3 + 57007 x 3 + 57010 x 3
1829	55830	576,40	57320 x 3 + 57007 x 3 + 57011 x 3
1939	55831	587,20	57320 x 3 + 57007 x 3 + 57012 x 3
2046	55832	609,90	57320 x 3 + 57010 x 6
2154	55833	623,00	57320 x 3 + 57007 x 3 + 57014 x 3
2264	55834	634,40	57320 x 3 + 57007 x 3 + 57015 x 3
2376	55835	644,00	57320 x 3 + 57010 x 3 + 57013 x 3
2481	55836	667,60	57320 x 3 + 57010 x 3 + 57014 x 3
2591	55837	679,90	57320 x 3 + 57010 x 3 + 57015 x 3
2701	55838	691,90	57320 x 3 + 57011 x 3 + 57015 x 3
2811	55839	703,40	57320 x 3 + 57013 x 3 + 57014 x 3
2916	55840	726,90	57320 x 3 + 57014 x 6
3026	55841	738,50	57320 x 3 + 57014 x 3 + 57015 x 3
3136	55842	750,00	57320 x 3 + 57015 x 6

Ref	€	Desglose · Breakdown
55866	666,00	57320 x 3 + 57007 x 4 + 57010 x 4
55867	681,60	57320 x 3 + 57007 x 4 + 57011 x 4
55868	696,60	57320 x 3 + 57007 x 4 + 57012 x 4
55869	726,40	57320 x 3 + 57010 x 8
55870	744,00	57320 x 3 + 57007 x 4 + 57014 x 4
55871	759,50	57320 x 3 + 57007 x 4 + 57015 x 4
55872	773,20	57320 x 3 + 57010 x 4 + 57013 x 4
55873	804,50	57320 x 3 + 57010 x 4 + 57014 x 4
55874	820,00	57320 x 3 + 57010 x 4 + 57015 x 4
55875	835,80	57320 x 3 + 57011 x 4 + 57015 x 4
55876	851,20	57320 x 3 + 57013 x 4 + 57014 x 4
55877	882,50	57320 x 3 + 57014 x 8
55878	897,90	57320 x 3 + 57014 x 4 + 57015 x 4
55879	913,40	57320 x 3 + 57015 x 8

Ref	€	Desglose · Breakdown
55903	767,60	57320 x 3 + 57007 x 5 + 57010 x 5
55904	787,20	57320 x 3 + 57007 x 5 + 57011 x 5
55905	806,60	57320 x 3 + 57007 x 5 + 57012 x 5
55906	843,00	57320 x 3 + 57010 x 10
55907	865,00	57320 x 3 + 57007 x 5 + 57014 x 5
55908	884,30	57320 x 3 + 57007 x 5 + 57015 x 5
55909	901,40	57320 x 3 + 57010 x 5 + 57013 x 5
55910	940,50	57320 x 3 + 57010 x 5 + 57014 x 5
55911	959,90	57320 x 3 + 57010 x 5 + 57015 x 5
55912	979,60	57320 x 3 + 57011 x 5 + 57015 x 5
55913	999,00	57320 x 3 + 57013 x 5 + 57014 x 5
55914	1.038,20	57320 x 3 + 57014 x 10
55915	1.057,30	57320 x 3 + 57014 x 5 + 57015 x 5
55916	1.076,60	57320 x 3 + 57015 x 10

L (mm)	Ref	€	Desglose · Breakdown
3275	55843	894,90	57320 x 4 + 57010 x 6 + 57012 x 3
3385	55844	906,50	57320 x 4 + 57010 x 6 + 57013 x 3
3490	55845	929,90	57320 x 4 + 57010 x 6 + 57014 x 3
3598	55846	943,10	57320 x 4 + 57007 x 3 + 57014 x 6
3710	55847	953,70	57320 x 4 + 57011 x 6 + 57014 x 3
3818	55848	966,30	57320 x 4 + 57007 x 3 + 57015 x 6
3925	55849	988,50	57320 x 4 + 57010 x 3 + 57014 x 6
4035	55850	1.000,30	57320 x 4 + 57011 x 3 + 57014 x 6
4145	55851	1.011,50	57320 x 4 + 57010 x 3 + 57015 x 6
4255	55852	1.023,60	57320 x 4 + 57011 x 3 + 57015 x 6
4360	55853	1.046,90	57320 x 4 + 57014 x 9
4470	55854	1.058,50	57320 x 4 + 57014 x 6 + 57015 x 3
4580	55855	1.070,20	57320 x 4 + 57014 x 3 + 57015 x 6
4690	55856	1.081,70	57320 x 4 + 57015 x 9

Ref	€	Desglose · Breakdown
55880	1.077,60	57320 x 4 + 57010 x 8 + 57012 x 4
55881	1.093,00	57320 x 4 + 57010 x 8 + 57013 x 4
55882	1.124,30	57320 x 4 + 57010 x 8 + 57014 x 4
55883	1.141,30	57320 x 4 + 57007 x 4 + 57014 x 8
55884	1.156,10	57320 x 4 + 57011 x 8 + 57014 x 4
55885	1.172,30	57320 x 4 + 57007 x 4 + 57015 x 8
55886	1.202,40	57320 x 4 + 57010 x 4 + 57014 x 8
55887	1.218,20	57320 x 4 + 57011 x 4 + 57014 x 8
55888	1.233,20	57320 x 4 + 57010 x 4 + 57015 x 8
55889	1.248,40	57320 x 4 + 57011 x 4 + 57015 x 8
55890	1.280,30	57320 x 4 + 57014 x 12
55891	1.295,80	57320 x 4 + 57014 x 8 + 57015 x 4
55892	1.310,60	57320 x 4 + 57014 x 4 + 57015 x 8
55893	1.326,60	57320 x 4 + 57015 x 12

Ref	€	Desglose · Breakdown
55917	1.260,20	57320 x 4 + 57010 x 10 + 57012 x 5
55918	1.279,50	57320 x 4 + 57010 x 10 + 57013 x 5
55919	1.318,00	57320 x 4 + 57010 x 10 + 57014 x 5
55920	1.340,60	57320 x 4 + 57007 x 5 + 57014 x 10
55921	1.357,70	57320 x 4 + 57011 x 10 + 57014 x 5
55922	1.379,10	57320 x 4 + 57007 x 5 + 57015 x 10
55923	1.416,20	57320 x 4 + 57010 x 5 + 57014 x 10
55924	1.436,10	57320 x 4 + 57011 x 5 + 57014 x 10
55925	1.454,80	57320 x 4 + 57010 x 5 + 57015 x 10
55926	1.474,60	57320 x 4 + 57011 x 5 + 57015 x 10
55927	1.513,80	57320 x 4 + 57014 x 15
55928	1.533,10	57320 x 4 + 57014 x 10 + 57015 x 5
55929	1.552,30	57320 x 4 + 57014 x 5 + 57015 x 10
55930	1.571,60	57320 x 4 + 57015 x 15

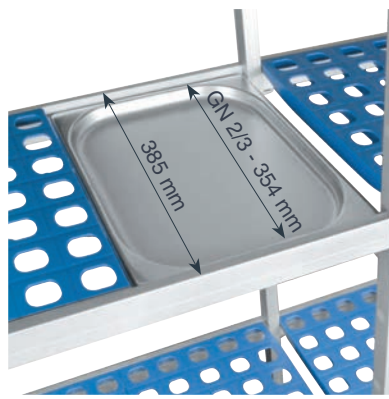

Fondo · Width: 385 mm  
Altura · Height: 1.750 mm

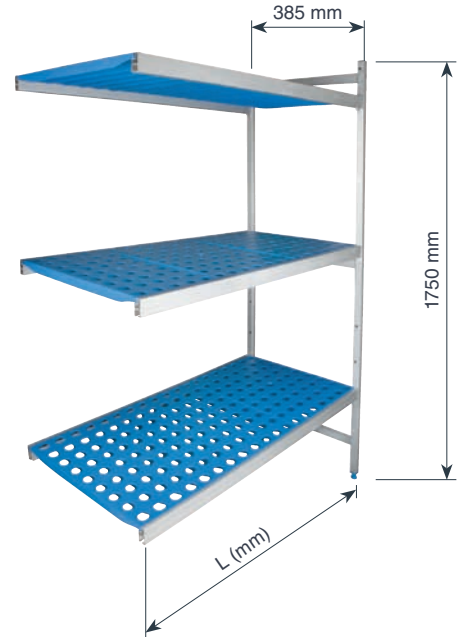

**Estantería completa**  
Rayonnage complet  
Volle Regale  
Full shelving  
Estantes completa

L (mm)	3 Estantes · Shelf			4 Estantes · Shelf			5 Estantes · Shelf		
	Ref	€	Desglose · Breakdown	Ref	€	Desglose · Breakdown	Ref	€	Desglose · Breakdown
682	55631	181,30	56317 x 1 + 56007 x 3	55640	218,50	56317 x 1 + 56007 x 4	55649	255,80	56317 x 1 + 56007 x 5
794	55632	187,30	56317 x 1 + 56008 x 3	55641	226,60	56317 x 1 + 56008 x 4	55650	265,90	56317 x 1 + 56008 x 5
904	55633	198,90	56317 x 1 + 56009 x 3	55642	242,10	56317 x 1 + 56009 x 4	55651	285,30	56317 x 1 + 56009 x 5
1009	55634	216,60	56317 x 1 + 56010 x 3	55643	265,60	56317 x 1 + 56010 x 4	55652	314,70	56317 x 1 + 56010 x 5
1119	55635	228,50	56317 x 1 + 56011 x 3	55644	281,50	56317 x 1 + 56011 x 4	55653	334,60	56317 x 1 + 56011 x 5
1229	55636	238,50	56317 x 1 + 56012 x 3	55645	294,70	56317 x 1 + 56012 x 4	55654	351,10	56317 x 1 + 56012 x 5
1339	55637	244,20	56317 x 1 + 56013 x 3	55646	302,50	56317 x 1 + 56013 x 4	55655	360,80	56317 x 1 + 56013 x 5
1472	55638	267,60	56317 x 1 + 56014 x 3	55647	333,70	56317 x 1 + 56014 x 4	55656	399,90	56317 x 1 + 56014 x 5
1554	55639	273,60	56317 x 1 + 56015 x 3	55648	341,60	56317 x 1 + 56015 x 4	55657	409,60	56317 x 1 + 56015 x 5

SIMPLE

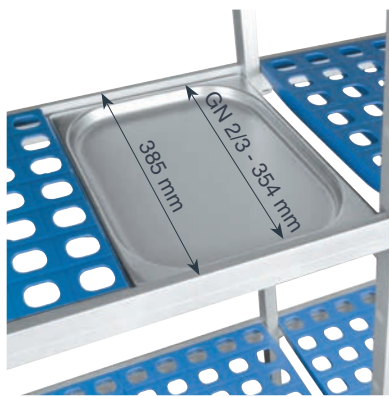

Fondo · Width: 385 mm  
Altura · Height: 2.000 mm

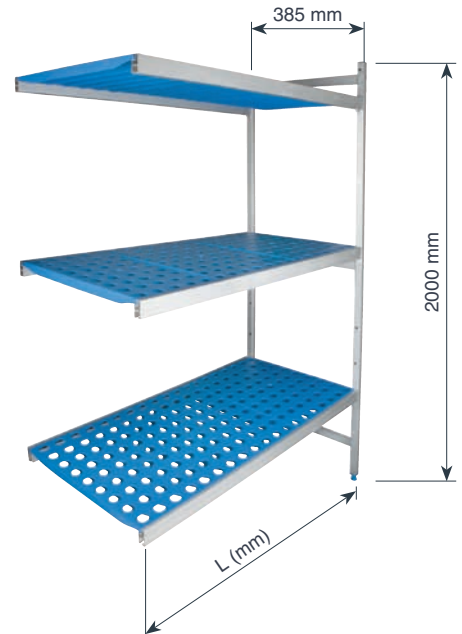

**Estantería completa**  
Rayonnage complet  
Volle Regale  
Full shelving  
Estantes completa

L (mm)	3 Estantes · Shelf			4 Estantes · Shelf			5 Estantes · Shelf		
	Ref	€	Desglose · Breakdown	Ref	€	Desglose · Breakdown	Ref	€	Desglose · Breakdown
682	55658	192,80	56320 x 1 + 56007 x 3	55667	230,00	56320 x 1 + 56007 x 4	55676	267,30	56320 x 1 + 56007 x 5
794	55659	198,90	56320 x 1 + 56008 x 3	55668	238,30	56320 x 1 + 56008 x 4	55677	277,50	56320 x 1 + 56008 x 5
904	55660	210,40	56320 x 1 + 56009 x 3	55669	253,70	56320 x 1 + 56009 x 4	55678	296,80	56320 x 1 + 56009 x 5
1009	55661	228,20	56320 x 1 + 56010 x 3	55670	277,20	56320 x 1 + 56010 x 4	55679	326,30	56320 x 1 + 56010 x 5
1119	55662	240,00	56320 x 1 + 56011 x 3	55671	293,00	56320 x 1 + 56011 x 4	55680	346,20	56320 x 1 + 56011 x 5
1229	55663	250,00	56320 x 1 + 56012 x 3	55672	305,50	56320 x 1 + 56012 x 4	55681	362,80	56320 x 1 + 56012 x 5
1339	55664	255,80	56320 x 1 + 56013 x 3	55673	314,00	56320 x 1 + 56013 x 4	55682	372,40	56320 x 1 + 56013 x 5
1472	55665	278,70	56320 x 1 + 56014 x 3	55674	345,40	56320 x 1 + 56014 x 4	55683	411,50	56320 x 1 + 56014 x 5
1554	55666	285,10	56320 x 1 + 56015 x 3	55675	353,10	56320 x 1 + 56015 x 4	55684	421,20	56320 x 1 + 56015 x 5

SIMPLE

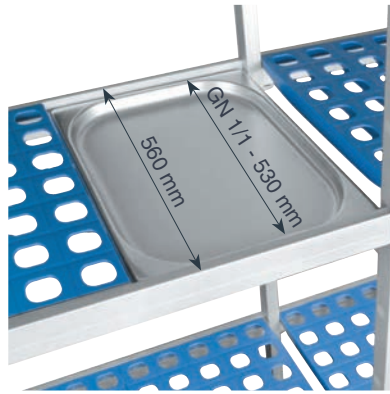

Fondo · Width: 560 mm  
Altura · Height: 1.750mm

**Estantería completa**

Rayonnage complet  
Volle Regale  
Full shelving  
Estantes completa

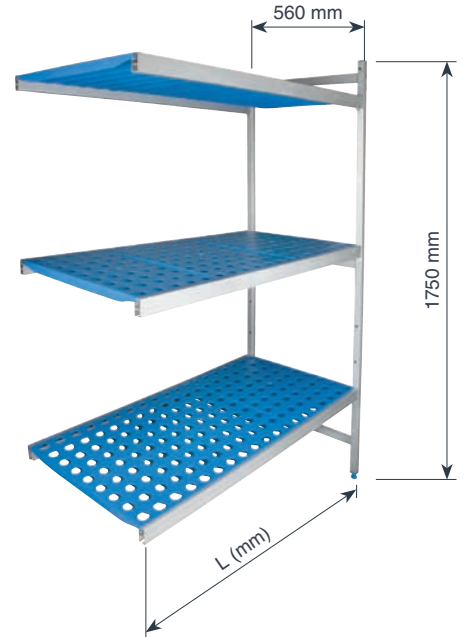

SIMPLE

**3 Estantes · Shelf**

**4 Estantes · Shelf**

**5 Estantes · Shelf**

L (mm)	Ref	€	Desglose · Breakdown	Ref	€	Desglose · Breakdown	Ref	€	Desglose · Breakdown
682	55931	204,60	57317 x 1 + 57007 x 3	55940	247,90	57317 x 1 + 57007 x 4	55949	290,40	57317 x 1 + 57007 x 5
794	55932	210,40	57317 x 1 + 57008 x 3	55941	255,60	57317 x 1 + 57008 x 4	55950	300,10	57317 x 1 + 57008 x 5
904	55933	222,40	57317 x 1 + 57009 x 3	55942	271,40	57317 x 1 + 57009 x 4	55951	320,50	57317 x 1 + 57009 x 5
1009	55934	250,00	57317 x 1 + 57010 x 3	55943	308,20	57317 x 1 + 57010 x 4	55952	366,60	57317 x 1 + 57010 x 5
1119	55935	261,80	57317 x 1 + 57011 x 3	55944	324,20	57317 x 1 + 57011 x 4	55953	386,40	57317 x 1 + 57011 x 5
1229	55936	273,60	57317 x 1 + 57012 x 3	55945	338,60	57317 x 1 + 57012 x 4	55954	405,80	57317 x 1 + 57012 x 5
1339	55937	285,10	57317 x 1 + 57013 x 3	55946	355,00	57317 x 1 + 57013 x 4	55955	425,00	57317 x 1 + 57013 x 5
1472	55938	307,50	57317 x 1 + 57014 x 3	55947	386,30	57317 x 1 + 57014 x 4	55956	464,10	57317 x 1 + 57014 x 5
1554	55939	320,20	57317 x 1 + 57015 x 3	55948	401,70	57317 x 1 + 57015 x 4	55957	483,40	57317 x 1 + 57015 x 5

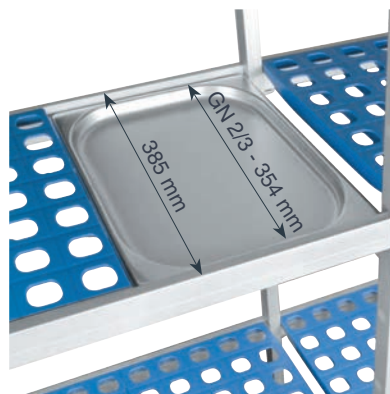

Fondo · Width: 560 mm  
Altura · Height: 2.000 mm

**Estantería completa**

Rayonnage complet  
Volle Regale  
Full shelving  
Estantes completa

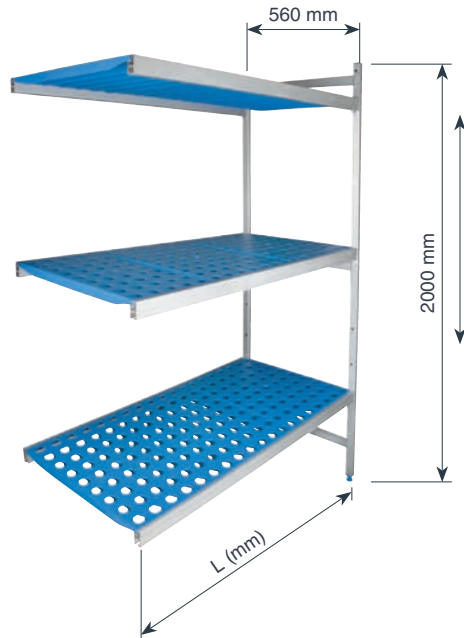

SIMPLE

**3 Estantes · Shelf**

**4 Estantes · Shelf**

**5 Estantes · Shelf**

L (mm)	Ref	€	Desglose · Breakdown	Ref	€	Desglose · Breakdown	Ref	€	Desglose · Breakdown
682	55958	216,30	57320 x 1 + 57007 x 3	55967	259,50	57320 x 1 + 57007 x 4	55976	302,20	57320 x 1 + 57007 x 5
794	55959	222,10	57320 x 1 + 57008 x 3	55968	267,10	57320 x 1 + 57008 x 4	55977	311,80	57320 x 1 + 57008 x 5
904	55960	233,90	57320 x 1 + 57009 x 3	55969	282,80	57320 x 1 + 57009 x 4	55978	331,20	57320 x 1 + 57009 x 5
1009	55961	261,50	57320 x 1 + 57010 x 3	55970	319,90	57320 x 1 + 57010 x 4	55979	378,20	57320 x 1 + 57010 x 5
1119	55962	273,60	57320 x 1 + 57011 x 3	55971	335,80	57320 x 1 + 57011 x 4	55980	397,90	57320 x 1 + 57011 x 5
1229	55963	285,10	57320 x 1 + 57012 x 3	55972	351,10	57320 x 1 + 57012 x 4	55981	417,30	57320 x 1 + 57012 x 5
1339	55964	296,60	57320 x 1 + 57013 x 3	55973	366,60	57320 x 1 + 57013 x 4	55982	436,60	57320 x 1 + 57013 x 5
1472	55965	320,20	57320 x 1 + 57014 x 3	55974	397,80	57320 x 1 + 57014 x 4	55983	475,60	57320 x 1 + 57014 x 5
1554	55966	331,70	57320 x 1 + 57015 x 3	55975	413,30	57320 x 1 + 57015 x 4	55984	495,00	57320 x 1 + 57015 x 5



A close-up photograph of a stainless steel burner on a gas stove. The burner is mounted on a blue plastic grate. In the foreground, a blue plastic rack with a grid pattern is visible. The background shows other burners and the stove's surface, all in a blue-tinted lighting.

Cestas  
Racks

#CocinaConLacor



La alta calidad de sus materiales hacen que la resistencia al calor y a los impactos sea óptima, por lo que su durabilidad está garantizada. Su sistema único de apilación permite un fácil montaje, y lo que es más novedoso, el desmontaje del mismo siempre que usted lo desee. Su estructura abierta permite una mayor rapidez en el lavado y secado, debido a una mejor circulación de agua y del aire. El diseño de las asas hacen que su manejo y carga sean cómodos y sin riesgos. Además, para facilitar su manejo, está disponible un carro porta cestas útil para evitar esfuerzos en los desplazamientos. Adaptable a la mayoría de las cestas existentes en el mercado.

The high quality of the materials used in this range give total protection against heat and shocks and thus guarantees durability. The unique folding system enables racks to be constructed and dismantled at will. The open structure enables a better circulation of both water and air for an easier wash and dry. The handle design makes loading and transport easy and risk-free. As an option a dolly is available to assist in the handling of racks. This product is compatible with the majority of other dishwasher baskets on the market.



Verificador de diámetros · Vérifiez le diamètre · Check the diameter · Diameter profungen · Medidor de diámetros

<b>49</b>	Compart. Teillen	64x64 mm
<b>36</b>	Compart. Teillen	75x75mm
<b>25</b>	Compart. Teillen	90x90 mm
<b>16</b>	Compart. Teillen	113x113 mm
<b>9</b>	Compart. Teillen	152x152 mm

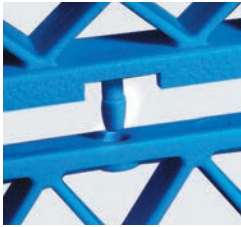

**Cesta Base**

Casier universel  
Spülkorb  
Universal open rack  
Cesta base



Ref	€	cm	Pack
69235	23,60	35x35x12	1
69240	25,10	40x40x11	1

**Cesta Base Universal**

Casier universel  
Universalspülkorb  
Universal open rack  
Cesta base universal



**Suplemento altura abierta**

Réhausse sans compart.  
Ergänzung  
Universal open extender  
Suplem. altura aberto



Ref	€	cm	Pack
69251	9,20	50x50x4,5	1

Ref	€	cm	Pack
69250	22,20	50x50x10,3	1

**Cesta base 16 compartimentos**

Casier 16 compartiments  
Spülkorb 16-tlg.  
Rack with 16 compartments  
Cesta base 16 compart.



**Suplem. altura 16 compartimentos**

Réhausse, 16 comp.  
Ergänzung 16-tlg. Spülkorb  
Extender for rack with 16 compart.  
Suplem. altura 16 compart.



Ref	€	cm	Pack
69217	11,30	50x50x4,5	1

Ref	€	cm	Pack
69214	26,40	50x50x10,3	1

**Cesta base 25 compartimentos**

Casier 25 compartiments  
Spülkorb 25-tlg.  
Rack with 25 compartments  
Cesta base 25 compart.



**Suplem. altura 25 compartimentos**

Réhausse, 25 comp.  
Ergänzung 25-tlg. Spülkorb  
Extender for rack with 25 compart.  
Suplem. altura 25 compart.



Ref	€	cm	Pack
69226	12,10	50x50x4,5	1

Ref	€	cm	Pack
69225	27,90	50x50x10,3	1

**Cesta base 36 compartimentos**

Casier 36 compartiments  
Spülkorb 36-tlg.  
Rack with 36 compartments  
Cesta base 36 compart.



**Suplem. altura 36 compartimentos**

Réhausse, 36 comp.  
Ergänzung 36-tlg. Spülkorb  
Extender for rack with 36 compart.  
Suplem. altura 36 compart.

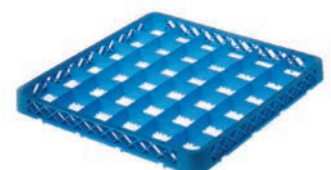

Ref	€	cm	Pack
69237	12,10	50x50x4,5	1

Ref	€	cm	Pack
69236	29,30	50x50x10,3	1

**Cesta base 49 compartimentos**

Casier 49 compartiments  
Spülkorb 49-tlg.  
Rack with 49 compartments  
Cesta base 49 compart.



Ref	€	cm	Pack
69249	30,20	50x50x10,3	1

**Suplem. altura 49 compartimentos**

Réhausse, 49 comp.  
Ergänzung 49-tlg. Spülkorb  
Extender for rack with 49 compart.  
Suplem. altura 49 compart.

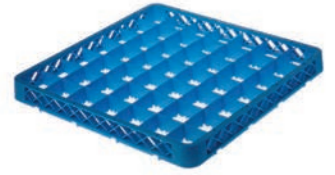

Ref	€	cm	Pack
69248	12,90	50x50x4,5	1

**Cesta para platos**

Casier pour assiettes  
Tellerspülkorb  
Small trays and dishes rack  
Cesta para pratos



Ref	€	cm	Pack
69202	22,30	50x50x10,3	1

**Cesta para platos**

Casier pour assiettes  
Tellerspülkorb  
Small trays and dishes rack  
Cesta para pratos

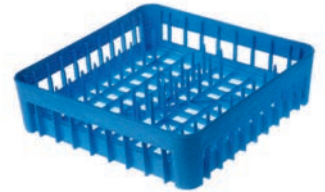

Ref	€	cm	Pack
69234	25,00	35x35x12	1
69241	33,80	40x40x11	1

**Cesta para platos / bandejas**

Casier pour grands platex  
Plattenspülkorb  
Universal open side trays rack  
Cesta Pratos/Bandejas



Ref	€	cm	Pack
69203	27,70	50x50x10,3	1

**Sup. varilla recubierta platillos**

Supplément assiettes  
Einsatz für Teller klein  
Coated wire plate basket  
Suplemento arame revestido p/pratos



Ref	€	cm	Pack
69207	7,10	31,0x9,5x7(15)	1
69213	8,30	34,5x9,5x7(17)	1

**Cesta para cubiertos**

Casier à couverts  
Besteckspülkorb  
Flatware/utensil rack  
Cesta para talheres



Ref	€	cm	Pack
69204	21,90	50x50x10,3	1

**Tapa cesta universal**

Couvercle pour casier universel  
Deckel für Universals Spülkorb  
Standard rack's lid  
Tampa cesta universal



Ref	€	cm	Pack
69205	17,40	50x50x2,5	1

**Cesta 8 compart. Cubiertos**

Panier à couverts, 8 compart.  
Besteckspülkorb 8 tlg.  
Cutlery rack with 8 compart.  
Cesta 8 compart. talheres



Ref	€	cm	Pack
69208	13,90	20,5x43x13	1

**Cubilete cubiertos**

Petit panier à couverts  
Besteckbehälter  
Cutlery cube  
Cesta talheres



Ref	€	cm	Pack
69215	4,30	12,5x12,5x13,5	1

**Carro porta-cestas**

Socle à roulettes pour casier  
Transportwagen fuer Spielkoerbe  
Trolley for racks  
Carro porta-cestas

Ref	€	cm	Pack	
69211	173,20	55x57x80	1	Con asa · With handle
69212	105,40	55x57x20	1	Sin asa · Without handle



Almac. - Limpieza  
Storage - Cleaning

#CocinaConLacor





**Papelera con pedal**

Poubelle à pédale  
Tret-Abfallbehälter  
Pedal bin  
Papeleira com pedal



Inox  
18% Cr

Ref	€	Ø (cm)	h (cm)	L	Pack
63303	17,70	17,0	25,5	3,0	6
63305	23,30	20,5	28,0	5,0	6
63312	34,30	25,0	40,0	12,0	6
63319	49,30	29,0	45,0	20,0	6

Inox



**Papelera sobremesa Inox 18/10**

Poubelle de table Inox 18/10  
Tish-Abfallbehälter, Rostfrei 18/10  
St. Steel 18/10 table bin  
Papeleira de mesa Inóx 18/10

Ref	€	Ø (cm)	L	Pack
63302	18,70	12x16	1,20	6



**Papelera sobremesa SOFT TOUCH**

Poubelle de table  
Tish-Abfallbehälter  
Table bin  
Papeleira de mesa

Ref	€	Ø (cm)	L	Pack
62358	21,30	12x16	1,20	6

Personalización para cantidades  
Personalisation pour des quantités  
Individuelle Gestaltung bei Abnahme  
Customization for quantities  
Personalização para quantidades  
**>500 u**



**Delantal de algodón**

Tablier en coton  
Schürze, Baumwolle  
Cotton Pinafore  
Avental de algodão

Ref	€	Pack
10004	9,60	1



**Cepillo recoge-migas**

Ramasse-miettes à rouleaux  
Krümelbürste  
Crumbs cleaner  
Escova apanha-migalhas

Ref	€	cm	h (cm)	Pack
64407	11,40	9,5x16,5	4,0	6



**Cepillo recogedor HIPERLUXE**

Ramasse-miettes à rouleaux HIPERLUXE  
Krümelbürste, HIPERLUXE  
HIPERLUXE crumbs cleaner  
Escova apanha-migalhas HIPERLUXE

Ref	€	cm	Pack
64408	37,30	14,5x17	1



**Cepillo recogedor LUXE**

Ramasse-miettes LUXE  
Krümelbürste, LUXE  
LUXE crumbs cleaner  
Espátula apanha-migalhas LUXE

Ref	€	cm	Pack
64409	24,50	22x7	1



Base contrapeso  
Base contre poids  
Balance-belastungs  
Counterbalance base  
Base contra-peso

1kg



**Pie portarollos**

Dériveur verticale pour papier essuie-tout  
Ständer für Serviettenrolle  
Kitchen roll dispenser stand  
Pé porta-rolos

Ref	€	Ø (cm)	Pack
50301	15,90	15x32,5	6

**A**



**B**



**Portarrollos de cocina de pared**

Derouleur de cuisine  
Serviettenspender  
Multiroll dispenser for kitchen  
Porta-rolos cozinha de parede

**Rollos aptos para los portarrollos · Rolls suitable for roll holders**

	Ref	€	Pack
<b>A</b>	60701	45,90	6
<b>B</b>	60702	43,30	8

Ref	Film transparente/Transparent Film	Rollo aluminio/Aluminium foil	Rollo papel/ Paper roll
60701	Ø50x320 mm	Ø50x320 mm	Ø180x330 mm
60702	Ø48x340 mm	Ø60x340 mm	Ø170x330 mm

**Bobina aluminio**

Rouleau aluminium  
Aluminium kunststoff-roht  
Aluminium foil  
Bobina alumínio



**Bobina film transparente**

Rouleau film transparent  
Rollfilm  
Transparent cling film  
Bobina filme transparente



Ref	€	Film (m)	Caja (cm)	Micras (µm)	Pack
10330	42,70	0,30x300	10x35	11	4
10430	52,40	0,40x300	10x42	11	4

Ref	€	Film (m)	Caja (cm)	Micras (µm)	Pack
11330	11,00	0,30x300	10x33	10	6
11430	16,90	0,45x300	10x48	10	8

Inox



**Servilletero Bar**

Distributeur de serviettes bar  
Serviettenspender  
Bar napkin holder  
Guardanapo bar

Ref	€	cm	Servilleta	Pack
61001	10,40	8,5x12	90x125	6

Inox



**Servilletero Bar**

Distributeur de serviettes bar  
Serviettenspender bar  
Bar napkin holder  
Guardanapo bar

Ref	€	cm	Servilleta	Pack
61002	7,20	9,5x13,5	90x125	4

ASA  
Acrylic



**Dispensador jabón de pared**

Distributeur mural à savon  
Wandspender seife  
Soap wall dispenser  
Dispensador de sabão parede



**Secador de manos con pulsador**

Sèche-mains à bouton  
Händetrockner mit Knopf  
Hand dryer with pusher  
Secador de mão com botão

Ref	€	cm	L	Pack
64501	25,70	13x13x21	1,3	1

Ref	€	cm	W	Pack
69501	275,60	26x15x23	2300	1



**Indicadores**

Signalétique lieux Publics  
Signal-Becken  
Toilet signal  
Bacia de sinal

Ref	€	Ø (cm)	Señal	Pack
61090	2,40	7,5	MAN	12
61091	2,40	7,5	WOMAN	12
61092	2,40	7,5	MIX	12
61093	2,40	7,5	WC	12
61094	2,40	7,5	NO SMOKING	12



**Cenicero redondo de pared**

Cendrier extérieur mural rond  
Wand Aschenbecher round  
Wall round ash try  
Cinzeiro de parede redondo

Ref	€	Ø (cm)	Pack
63331	73,60	8x46	12



**Cenicero redondo de pie**

Ronde cendrier  
Stand Aschenbecher round  
Stand round ash try  
Cinzeiro de pie redondo

Ref	€	Ø (cm)	Pack
63332	117,60	8x92	1







REPOSTERÍA

•

PASTRY

Preparación Repostería

*Pastry Processing*

•

Moldes - Aros

*Moulds - Cake Rings*



## Medidores

Inox  
18/10**Cuchara medidora digital**

Cuillère avec Balance Digital  
Digitale Löffelwaage  
Digital spoon scale  
Colher de pesar Digital

Ref	€	g	División (g)	L (cm)	Pack
62519	32,30	300	0,10	28	6

**Jarra 5 litros Inox 18/10**

Pot en inox 5 lts en Inox 18/10  
Wasserkanne 5 L, Edelstahl 18/10  
Stainless steel 18/10 5 L pitcher  
Jarra 5 L Inóx 18/10



Ref	€	Ø (cm)	L	Pack
62750	58,60	Ø17x22,5	5,00	1

Inox  
18/10AS  
Plastic  
BPA free**Jarra de medidas cónica**

Pot mesureur  
Mass Behälter  
Measuring cup  
Jarra de medidas cónica

Ref	€	L	Pack
67010	27,00	1,00	1

**Jarra medidora doble**

Double pot mesureur  
Dual Mass Behälter  
Dual measuring jug  
Jarra de medidas dupla



Ref	€	Unidades	ml	Pack
67137	10,30	ml-oz-cup	500-100	6

PP  
Polypropylene  
BPA freeSAN  
Plastic  
BPA free**Jarra medidora Polipropileno**

Pot mesureur en polypropylène  
Mass Behälter aus Polipropilen  
Polypropylene measuring jug  
Jarra de medidas polipropileno

Ref	€	ml	Pack
67136	3,70	500	1

**Juego 3 jarras medidoras SAN**

Ensemble de 3 pot mesureur SAN  
3 tlg. satz mass behälter, SAN  
SAN 3 piece measuring jugs  
Jogo 3 jarras de medidas SAN

Ref	€	ml	Pack
67131	11,30	250-500-1000	1

Inox  
18/10**Jgo. de 5 cucharas medidoras**

Ensemble de 5 cuillères à doser  
Messlöffel-Set 5 tlg.  
5 piece measuring set  
Jogo de 5 colheres de medidas

Ref	€	ml	Pack
67001	8,70	0,62-1,25-2-5-15	12

**Jgo. cazos de medidas Inox 18% Cr.**

Ensemble de 4 dosettes inox 18% Cr.  
Mass-Pfännchen-Set, Edelstahl 18% Cr.  
Measuring cup 4 pieces s. steel 18% Cr.  
Jogo caçaroles de medidas Inóx 18% Cr.

Ref	€	ml	Pack
67007	9,50	60-80-125-250	4

**Librador**

Pelle à farine  
Mehlschaufel  
Ice shovel  
Corredor



Ref	€	ml	L (cm)	Pack
67012	14,00	60	19,0	1
67013	16,30	110	21,5	1
67014	19,20	200	24,0	1
67016	21,50	260	25,5	1
67017	23,40	360	29,0	1
67018	25,60	470	31,0	1
67019	31,90	640	35,0	1
67020	38,50	860	38,0	1

**Librador**

Pelle à farine  
Mehlschaufel  
Ice shovel  
Corredor



	Ref	€	ml	Pack
<b>A</b>	67021	4,60	170	6
<b>B</b>	67022	9,40	900	6
<b>C</b>	67023	12,90	1800	6



**Bol cónico Inox 18% Cr.**

Bol conique inox 18% Cr.  
Schüssel, konisch, Edelstahl 18% Cr.  
st. steel 18% Cr. conical mixing bowl  
Bacia cónica Inóx 18% Cr.



Ref	€	Ø (cm)	h (cm)	L	Pack
14016	2,80	16	6,5	0,90	1
14019	4,00	20	7,5	1,40	1
14025	7,40	24	9,0	2,50	1
14029	9,90	30	11,0	4,30	1
14033	13,90	34	13,5	7,50	1

**Fuente honda cónica**

Bassine pâtisseries  
Schüssel, tief, konisch  
Deep and conical dish  
Bacia alta cónica



Ref	€	Ø (cm)	h (cm)	L	Pack
60013	9,70	13	6,1	0,55	1
60016	10,50	16	9,1	1,00	1
60020	14,50	20	11,7	2,12	1
60024	17,40	24	12,6	3,50	1
60028	21,90	28	13,4	5,25	1
60032	23,80	32	15,0	7,65	1
60036	34,00	36	16,0	11,00	1
60040	39,40	40	18,0	15,00	1



## Cedazos

## Cedazo

Tamis  
Mehlsieb  
Sieve  
Peneira



Hilos por pulgada · Wires-inch= 50

Ref	€	Ø (cm)
68052	21,90	12
68056	26,00	16
68058	30,90	18
68050	34,00	20
68057	47,00	26
68053	56,60	30
68054	77,30	40

Hilos por pulgada · Wires-inch= 35

Ref	€	Ø (cm)
68350	31,00	20
68357	46,70	26
68351	52,80	30
68354	79,00	40

Hilos por pulgada · Wires-inch= 25

Ref	€	Ø (cm)
68250	30,80	20
68252	46,80	26
68253	51,60	30
68254	79,80	40

Hilos por pulgada · Wires-inch= 20

Ref	€	Ø (cm)
68026	48,50	26
68023	53,50	30
68024	80,70	40

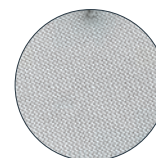
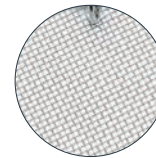
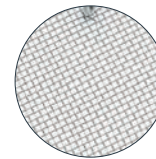
50 orificios/pulgada  
50 eyes/inch35 orificios/pulgada  
35 eyes/inch25 orificios/pulgada  
25 eyes/inch20 orificios/pulgada  
20 eyes/inch

## Cedazo 4 mallas intercambiables

Tamis à 4 mailles interchangeables  
4 Austauschbare Masche-Sieb.  
Mesh sieve interchangeable  
Peneira de 4 malha intercambiáveis

Ref	€	Ø (cm)	Pack
68340	26,20	20	1
68341	31,70	23	1
68342	39,40	25	1

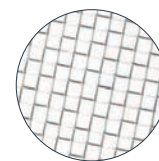
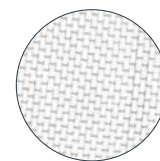
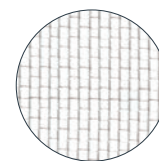
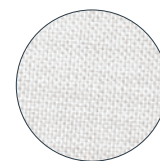
8 orificios/pulgada  
8 eyes/inch22 orificios/pulgada  
22 eyes/inch12 orificios/pulgada  
12 eyes/inch40 orificios/pulgada  
40 eyes/inch

## Cribador de harina Inox 18%

Tamis inox 18%  
Mehlsieb, Edelstahl 18%  
Flour sifter s. steel 18%  
Cribador de farinha Inóx 18 %

Ref	€	Ø (cm)	Kg	Pack
67011	8,30	10,0	0,35	5
67015	11,20	12,0	0,50	6



Se acciona con el mecanismo que incorpora en el asa en forma de gatillo  
Se puede utilizar con chocolate en polvo, levaduras, etc...

Fonctionne grâce au mécanisme intégré dans sa poignée en forme de gâchette  
Peut être utilisé avec du chocolat en poudre, des levures, etc.

Die Betätigung erfolgt über den im Griff integrierten Drückermechanismus  
Kann mit Schokoladenpulver, Hefe usw. verwendet werden

It is activated with the trigger-shaped mechanism on the handle  
It can be used with powdered chocolate, yeast, etc.

Aciona-se com o mecanismo que incorpora na asa, em forma de gatilho  
Pode utilizar-se com chocolate em pó, levaduras, etc.

## Cribador de harina

Tamis  
Mehlsieb  
Flour sifter  
Cribador de farinha

Ref	€	Ø (cm)	Kg	Pack
67025	5,70	10	0,35	6

ASA  
Acrylic

## Batidores

SI 250°C  
Silicone max.

### Batidor silicona FIBREGLASS

Fouet en silicone FIBREGLASS  
FIBREGLASS Schneebesen, Silikon  
FIBREGLASS silicone whisk  
Batedores silicona FIBREGLASS



Ref	€	L (cm)	Pack
61524	8,70	25	6
61529	9,60	30	6
61534	11,20	35	6
61539	11,70	40	6

Indeformable - Ergonómico  
Indeformable - Ergonomic

### Batidor FIBREGLASS

Fouet FIBREGLASS  
FIBREGLASS Schneebesen  
FIBREGLASS Whisk  
Batedores FIBREGLASS



Ref	€	L (cm)	Pack
61624	9,70	25	6
61629	11,10	30	6
61634	12,60	35	6
61639	14,00	40	6
61644	16,70	45	6
61649	17,50	50	6

Indeformable - Ergonómico  
Indeformable - Ergonomic

### Batidor EXTRA 8

Fouet inox extra 8  
Schneebesen, Extra 8  
Extra 8 whisk  
Batedor Extra 8



Ref	€	L (cm)	Pack
61625	7,00	25	12
61630	7,10	30	12
61635	7,50	35	12
61640	8,30	40	12
61645	8,90	45	12
61650	10,10	50	12
61655	10,60	55	12
61660	11,50	60	12

### Batidor SUPER 12

Fouet inox super 12  
Schneebesen, super 12  
Super 12 whisk  
Batedor Super 12



Ref	€	L (cm)	Pack
61626	6,40	25	12
61631	6,90	30	12
61636	7,50	35	12
61641	7,90	40	12
61646	8,20	45	12
61651	8,90	50	12

### Batidor MINI Inox

Mini fouet Inox  
Mini-Schneebesen  
Mini whisk  
Mini batedor Inóx



Ref	€	L (cm)	Pack
61615	4,40	15	6
61620	4,90	20	6

SI 250°C  
Silicone max.

### Batidor varilla silicona

Fouet en silicone  
Rührbesen auf Silikon  
Silicone wirw whisk  
Batedor vareta silicone



Ref	€	L (cm)	Pack
61621	6,40	20	12
61622	7,10	25	12
61623	7,80	30	12

### Batidor Gigante

Fouet á purée  
Kesselbesen  
Big whisk  
Batedor gigante



Ref	€	cm	Pack
60610	49,80	100	1
60612	63,70	129	1

### Batidor manivela Inox 18% Cr.

Batteur-mélangeur à manivelle 18% Cr.  
Schneequir  
Egg beater 18% Cr.  
Batedor de manivela Inóx 18%Cr.



Ref	€	Pack
62901	15,00	12

### Batidor Capuccino

Batteur pour Cappuccino  
Capuccino- Mixer  
Capuccino mixer  
Batedor capuccino



Ref	€	W	Pack
69041	20,70	2,7	1

## Rodillos

(A) LONGITUD TOTAL · Total length  
(B) LONGITUD ZONA DE USO · Length area of use

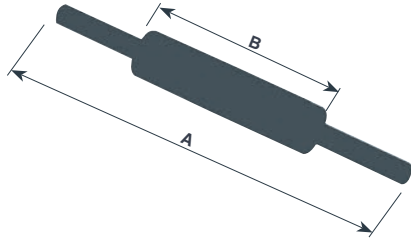

**Rodillo de amasar**  
Rouleau à pâtisserie  
Teigroller  
Rolling pin  
Rolo de amasar

Ref	€	Ø (cm)	L (cm)	Pack
68147	9,00	2,5	22,8	6
68148	11,80	3,0	30,0	6
68141	28,80	4,4	43,0	1
68151	35,20	4,8	50,0	1

### Rodillo Inox 18/10

Rouleau pâtisier inox 18/10  
Teigroller, Rostfrei 18/10  
Rolling pin s. steel 18/10  
Rolo Inóx 18/10

Ref	€	A (cm)	B (cm)	Pack
67140	33,60	40	20	3
67148	37,50	48	25	4
67156	40,10	56	33	4

### Rodillo

Rouleau patisier  
Teigroller  
Rolling pin  
Rolo

Ref	€	A (cm)	B (cm)	Pack
67141	33,70	40	20	3
67149	38,50	48	25	4

PE  
Polyéthilène



HAYA  
Wood



### Rodillo de madera de Haya

Rouleau pâtisier en hêtre  
Teigroller, Buchenholz  
Beechwood rolling pin  
Rolo de madeira de faia

Ref	€	Ø (cm)	L (cm)	Pack
68142	7,70	4,4	43	1
68150	8,20	4,8	50	1

HAYA  
Wood



### Rodillo de madera de Haya con mango

Rouleau pâtisier en hêtre a/poignée  
Teigroller, Buchenholz  
Beechwood rolling pin with handle  
Rolo de madeira de faia com cabo

Ref	€	A (cm)	B (cm)	Pack
68153	8,60	50	30	1
68154	16,70	60	40	1



HAYA  
Wood

PP  
Polypropilène

### Rodillo amasar con anillas

Rouleau hêtre avec anneaux  
Teigroller mit weinring  
Rolling pin with guide rings  
Rolo com anilhas

Ref	€	L (cm)	Pack
67142	12,40	38	6

### Discos extraíbles consigue masa de distinto grosor (2-6-10 mm) Grabado en la madera Guía para medir el ancho de la masa

Disques extractibles, obtenez des masses d'épaisseurs différentes  
Gravé dans le bois, un Guide pour mesurer la largeur de la masse

Austauschbaren Scheiben sind verschiedene Hackgrößen möglich  
Im Holz eingelassen Lineal zum Messen der Tischbreite

Removable discs you can achieve a mass of different thicknesses  
There is a mass thickness measuring guide engraved in the wood

Discos extraíveis, obtenha massa de distinta grossura  
Gravado na madeira Guia para medir a largura da massa

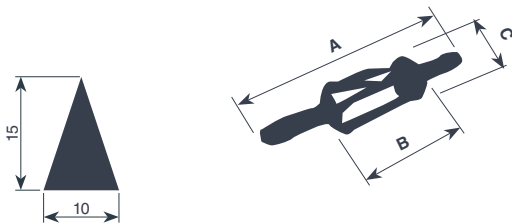

### Rodillo cortador Croissant

Rouleau pour coupe Croissant  
Kleines/Grosses Croissant  
Croissant dough cutter wheel  
Rolo cortador de croissants

Ref	€	A (cm)	B (cm)	C (Ø cm)	Pack
68161	27,40	40,5	15,3	7,7	1



### Rodillo picar pasta

Rouleau pique vite pointe metal  
Teig-Gitterschneider  
Roller docker metal  
Rolo de picar massas

Ref	€	L (cm)	Pack
68213	29,50	13	6



## Rasquetas

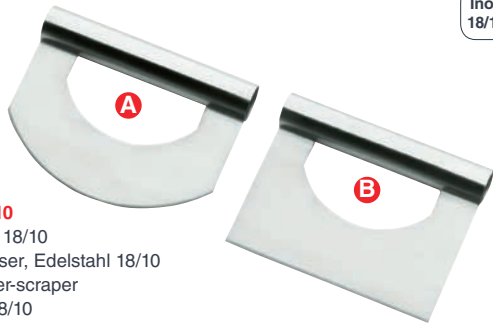

Inox  
18/10

Inox

### Rasqueta Inox 18/10

Coupe pate en Inox 18/10  
Einhand-Wiegemesser, Edelstahl 18/10  
St steel 18/10 hopper-scraper  
Raspador en Inóx 18/10

	Ref	€	cm	Pack
<b>A</b>	67005	10,10	15x9	1
<b>B</b>	67006	10,00	15x9	1

### Rasqueta

Coupe pate  
Schaufel  
Scraper  
Raspador



	Ref	€	cm	Pack
	67029	7,50	16,5x11	6



SI  
Silicone

230°C  
Max.

### Rasqueta silicona

Coupe pate en Silicone  
Schaufel, Silikon  
Silicone chopper  
Raspador silicone

	Ref	€	cm	Pack
	67414	7,40	9x15	6

### Estecas decoración Fondant

Outils de modelisation de Fondant  
Fondant modellie Rungstools  
Fondant modeling tools  
Ferramentas demodelagen Fondant



ABS  
Plastic

BPA free

	Ref	€	Piezas	Pack
	68090	9,10	12	12

### Rasqueta decoración

Grattoir à pate  
Kunststo Teigshaber  
Dough scraper  
Raspador de masa

	Ref	€	mm	Pack
<b>A</b>	68131	1,20	134x94	24
<b>B</b>	68132	1,30	155x105	24
<b>C</b>	68133	1,40	190x124	24



### Peine decoración

Peigne du decoration  
Dekorieren Plastikamme  
Decorating comb  
pente de decoração

	Ref	€	mm	Pack
<b>A</b>	68134	1,20	90	24
<b>B</b>	68135	1,20	100	24
<b>C</b>	68136	1,20	110	24



### Juego peines decoración

Set peigne du decoration  
Dekorieren Plastikamme Set  
Decorating comb set  
Jogo pente de decoração

	Ref	€	Piezas	Pack
	68137	4,60	7	24



### Juego decoración repostería

Set de decoration pâtisserie  
Gebäck Dekorieren Spiel  
Pastry decoration set  
Jogo de decoração pastelaria

	Ref	€	Piezas	Pack
	61419	6,30	100	60



PP  
Polipropileno

BPA free



## Espátulas · Pinceles

## Utensilios que no pueden faltar en tu cocina

Distintos tipos de espátulas y pinceles resistentes a altas temperatura

Prácticas espátulas o lenguas de gatos para rebañar boles, cazuelas, fuentes, etc.

Pinceles para untar o decorar los alimentos con huevo, azúcar, salsas,...

Des ustensiles qui ne peuvent pas manquer dans votre cuisine

Différents types de spatules et de pinceaux résistants à de hautes températures  
Pratiques spatules ou langues de chats pour récupérer les éléments restant dans les bols, casseroles, plats, etc.

Pinceaux pour badigeonner ou décorer les aliments avec de l'œuf, du sucre, des sauces, ...

Kochzubehör, das Du in der Deiner Küche nicht missen möchtest

Hitzebeständige Spachtel und Pinsel in verschiedenen Varianten

Praktische Spachtel oder Schaber zum auskratzen von Schalen, Kasserollen, Schüsseln, etc.

Pinsel zum Auftragen und Verzieren von Speisen mit Ei, Zucker, Saucen, usw.

Must-have utensils for your kitchen

Different types of spatulas and brushes that are resistant to high temperatures

Practical spatulas for scraping bowls, pots, dishes, etc.

Brushes for basting or decorating foods with egg, sugar, sauces,...

Utensílos que não podem faltar na tua cozinha

Diferentes tipos de espátulas e pincéis, resistentes a altas temperatura

Práticas espátulas ou "línguas de gato" para barrar bolos, caçarolas, formas e travessas, etc.

Pincéis para untar ou decorar os alimentos com ovo, açúcar, molhos,...

## Espátula Silicona

Spatule en silicone

Teigschaber

Silicone spatula

Espátula de silicone



Ref	€	L (cm)	Pack
67421	3,60	20	12
67427	5,50	26	12
67433	12,10	32	12

## Espátula Silicona

Spatule en silicone

Teigschaber

Silicone spatula

Espátula de silicone

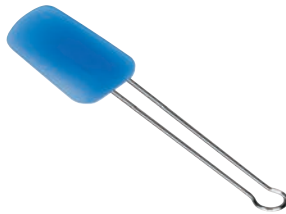

Ref	€	cm	Pack
67434	3,70	7,5x5	12
67435	4,20	9x6	12



## Espátula Silicona

Spatule en silicone

Teigschaber

Silicone spatula

Espátula de silicone

	Ref	€	L (cm)	Pack
A	64444	4,70	28	12
B	64445	5,30	30	12
C	64446	5,40	31	12

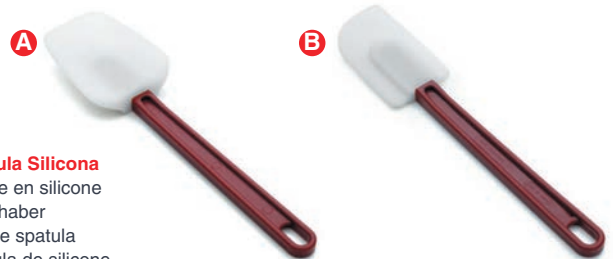

## Espátula Silicona

Spatule en silicone

Teigschaber

Silicone spatula

Espátula de silicone

	Ref	€	L (cm)	Pack
A	64450	4,40	25	6
A	64451	7,20	35	6
B	64460	4,70	25	6
B	64461	7,80	35	6



## Pincel de Silicona Inox 18/10

Pinceau en silicone Inox 18/10

Silikonpinsel, Rostfrei 18/10

St. steel 18/10 silicon brush

Pincel silicone inox 18/10

	Ref	€	L (cm)	Pack
A	64418	8,60	22	6
B	64422	9,80	23	6
C	64438	10,40	24	6



**Pincel virola Inox mango Polipropileno**

Pinceau patisier V. Inox M. Polipropylene  
Fett-/Kuchenpinsel, mit Stiel aus Polypropylen, schaft Edelstahl  
Flat pastry brush s.steel Polypropylene handle  
Pincel aro Inóx cabo polietileno

Ref	€	cm	Pack
64430	3,40	4,4x3,0	20
64435	4,00	4,4x3,5	20
64440	4,20	4,4x4,0	20
65044	5,20	5,0x4,5	20
65050	6,20	5,0x5,0	20

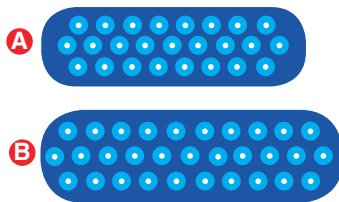

Dimensiones Reales - Real Dimensions



180°C  
Max.



**Pincel de silicona mango Inox**

Pinceau de cuisine embout en silicone  
Silikonpinsel, langer stiel  
Silicone brush st.steel long handle  
Pincel de silicone cabo Inóx 18/10

Ref	€	L (cm)	Pack
A 64425	5,30	24	12
B 64431	5,70	24	12

**Pincel de Silicona**  
Pinceau en silicone  
Silikonpinsel,  
Silicon brush  
Pincel de silicone

Ref	€	L (cm)	Pack
64441	5,00	23	12



**Set repostería (20 pcs.)**

Exposit pâtisserie  
Ausstellendkasten, pastry  
Pastry display  
Expositor pasteleria

Ref	€	L (cm)	Pieza	Pack
A 64424	60,10	-	Caja (20 pcs) / Set (20 pcs)	1
B 64426	3,00	23,0	Pincel / Brush	12
C 64427	3,00	23,0	Espátula / Spatula	12
D 64428	3,00	23,0	engua gato / Spatula	12
E 64429	3,00	23,0	Batidor / Whisk	12

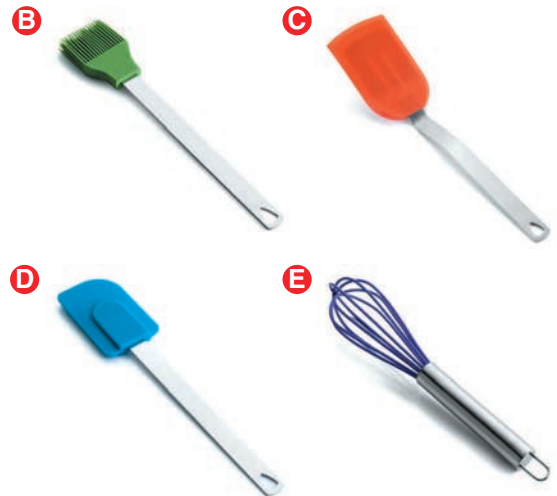

## Cortapastas

## Juego 6 cortapastas variados

Ensemble 6 decoupoirs divers  
6 Tlg. Teigausstecher  
6 pcs. Assorted cookie cutters set  
Jogo 6 corta-massas variados

	Ref	€	Pack
<b>A</b>	68064	6,60	12
<b>B</b>	68065	6,60	12



## Caja de 9 cortapastas redondos

Boîte de 9 decoupoirs ronds unis  
9 TLG. Teigausstecher, rund, glatt  
Set of 9 round dough cutters  
Caixa de 9 corta-massas ovais redondos

Ref	€	h (cm)	Pack	
68069	22,20	4,2	6	Liso · Pain
68070	24,10	4,2	6	Rizado · Fluted

## Medidas

Sizes (cm): Ø2 / Ø3 / Ø4 / Ø5 / Ø6 / Ø7 / Ø8 / Ø9 / Ø10



PA  
Nylon

40°C  
Max

## Caja de 9 cortapastas redondos









Boîte de 9 decoupoirs ronds unis  
9 TLG. Teigausstecher, rund, glatt  
Set of 9 round dough cutters  
Caixa de 9 corta-massas ovais redondos

Ref	€	h (cm)	Pack	
68091	20,10	3,50	6	Liso · Pain
68092	20,10	3,50	6	Rizado · Fluted

## Medidas

Sizes (cm): Ø2 / Ø3 / Ø4 / Ø5 / Ø6 / Ø7 / Ø8 / Ø9 / Ø10



-  Paloma · Dove
-  Beso · Kiss
-  Osito · Teddy bear
-  Corazón · Heart
-  Flecha · Arrow
-  Nube · Cloud
-  Rock · Rock
-  Ángel · Angel

## Set 8 cortadores galletas

Set 8 emporte-pièces  
8-Tlg. Ausstechformen  
Cookies cutters set  
Set 8 cortadores de biscoito

	Ref	€	Ø (cm)	Forma	Pack
<b>A</b>	68086	13,30	5	San Valentín · Valentine's day	1
<b>B</b>	68087	13,30	5	Navidades · Christmas	1



-  Hoja · Leave
-  Ángel · Angel
-  Palote · Candy cane
-  Campanilla · Bell
-  Osito · Teddy bear
-  Muñeco nieve · Snow man
-  Abeto · Christmas tree
-  Adorno · Decoration

Cerrado · Closed: 5,5x24 cm  
Abierto · Open: 49,5x24 cm  
Cuchillas · Blades: Ø5,5 cm



## Cortapastas extensibles 5 ruedas

Rouleau multicoupe 5 rouletes en Inox 18% Cr  
Teigschneider, Edelstahl 18% Cr  
S. steel 18% Cr dough divider expandable  
Corta-massas extensível 5 rodas

Ref	€	Pack
68246	42,00	1

## Sierra sueca 3 cortes

Scie à gâteaux 3 lames  
Schweifsäge 3 Schnider  
3 blades swedish saw  
Serra suexa 3 lâminas

Ref	€	cm	Pack
68515	111,30	53x23	12



## Dosificadores



*Ideal para rellenar,  
verter y decorar*

*Idéal pour garnir,  
verser et décorer*

*Ideal for filling, pouring  
and decorating*



Diseño premiado en certámenes internacionales  
International award-winning ow  
Good Design 2003 International Industrial  
Graphic Design Competition The Chicago Athenaeum

### Dosificador

Entonnoir à decor  
Dosierer  
Portionner  
Dosificador

Ref	€	L	Pack
67000	72,00	2,00	1

### Cono Inox 18/10

Cône  
Trichter  
Cone  
Cone Inóx 18/10

Ref	€	L	Pack
R67000	32,00	2,00	1



### Soporte mango

Support  
Stütze  
Support  
Suporte cabo

Ref	€	Pack
R67001	28,80	1



### Base negra

Base noire  
Ständer, schwarz  
Black base  
Base negra

Ref	€	Pack
R67002	11,30	1



### Boquillas

Douille  
Düse  
Nozzle  
Boquilhas

	Ref	€	Ø (mm)	Pack
<b>A</b>	R67003	1,30	-	1
<b>B</b>	R67004	1,50	4	1
<b>C</b>	R67005	1,50	6	1
<b>D</b>	R67006	1,50	8	1

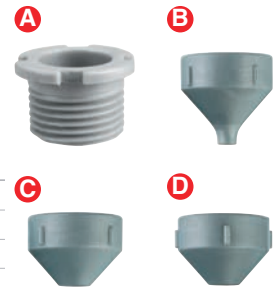

### Dispensador de repostería

Distributeur de pâtisserie  
Tüllensätzespender  
Batter dispenser  
Distribuidor de pastelería

Ref	€	L	cm	Pack
67026	9,50	1,00	16x11x18	6



### Marcas de medición en el contenedor (ml - cups) Ahorra tiempo sobre los sistemas tradicionales Sistema antigoteo y salpicaduras

Marques de mesure dans le conteneur (ml - cups)  
Économie de temps par rapport aux systèmes traditionnels  
Système anti-goutte et anti-éclaboussures

Messmarken am Behälter (ml - cups)  
Zeitsparend gegenüber traditionellen Systemen  
Antitropf- und Antispritzsystem

Measurement markings on the container (ml - cups)  
Saves time over traditional systems  
Anti-drip and anti-splash system

Marcas de medição no recipiente (ml - taças)  
Poupa tempo em comparação com os sistemas tradicionais  
Sistema anti-gotejamento e salpicaduras



# Pistola Gas



GOOD DESIGN  
PRODUCT

**Autoencendido por Piezoeléctrico**  
**Control ajustable de llama**  
**Llama antiretorno**  
**Sistema seguro de bloqueo**  
**Fácil rellenado de gas butano**

Auto-allumage par piézoélectrique  
Contrôle de flamme réglable  
Flamme antiretour  
Système de blocage sécurisé  
Facile remplissage de gaz butane

Selbsttätige piezoelektrische Zündung  
Einstellbare Flamme  
Anti-Rückschlag-Flamme  
Sicherheitsverriegelung  
Einfache Butangas-Nachfüllung

Auto power by piezoelectric sensor  
Adjustable flame control  
Non-return flame  
Safe stop system  
Easy filling of butane gas

Autoignição piezoelétrica  
Controlo de chama ajustável  
Chama anti-retorno  
Sistema seguro de bloqueio  
Fácil de encher com gás butano



## Pistola Gas repostería

Torche à caraméliser  
Brullierbrenen  
Pastry Gas Torch  
Queimadora a Gás para pastelaria

	Ref	€	Cap. (ml)	h (cm)	Pack
<b>A</b>	68981	14,90	5-6	12,50	20 Micro
<b>B</b>	68982	24,10	19	17,00	10 Mini
<b>C</b>	68983	33,10	65	18,00	10 Chef
<b>D</b>	68988	42,50	40	16,00	12 Profesional



Cuando el orificio de entrada de oxígeno este descubierto la llama será más intensa

When the oxygen inlet is uncovered, the flame will be more intense

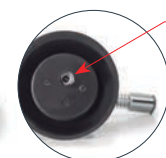

Válvula recarga gas  
Refill valve

## Pistola Gas repostería

Torche à caraméliser  
Brullierbrenen  
Pastry Gas Torch  
Queimadora a Gás para pastelaria

	Ref	€	Cap. (ml)	h (cm)	Pack
	68969	17,70	21	13,00	6

## Soplete · Quemador



**Adaptador para poder utilizar distintos tipos de botellas de gas**  
 Adaptateur pour pouvoir utiliser différents types de bouteilles de gaz  
 Adapter für verschiedene Gasflaschen  
 Adapter enables it to be used with different types of gas bottles  
 Adaptador para poder utilizar diferentes tipos de garrafas de gás



### Cabezal soplete gas PROFESIONAL + Adaptador

Torche à caraméliser PROFESSIONNEL + Adaptateur  
 PROFI Brullierbrenen + Adapter  
 PROFESSIONAL blow torch head + Adapter  
 Queimadora a gás PROFESIONAL + Adaptador

Ref	€	W	Consumo (g/h)	Pack
68974	20,20	1,65	120	10

Botella de gas NO incluida · Gas of bottle NOT included

### Cabezal soplete gas PROFESIONAL

Torche à caraméliser PROFESSIONNEL  
 PROFI Brullierbrenen  
 PROFESSIONAL blow torch head  
 Queimadora a gás PROFESIONAL

Ref	€	W	Consumo (g/h)	Pack
68984	13,00	1,65	120	1

Botella de gas NO incluida · Gas of bottle NOT included

### Queimador crema fundición

Fer à caraméliser  
 Brenner  
 Caramelizer  
 Queimador leite-creme fundição

Ref	€	Ø (cm)	Pack
68650	14,30	10	1



### Queimador eléctrico redondo

Fer à caraméliser électrique rond  
 Elektro-Brenner, rund  
 SRound electric caramelizer  
 Queimador eléctrico redondo

Ref	€	Pack
68651	88,70	1
68652	102,50	1



Ref	Tensión/Voltage	Potencia/Power	Dimensiones/Sizes	Peso/Weight
68651	220-230 V / 50-60 Hz	650 W	Ø10 cm	1,132 Kg
68652	220-230 V / 50-60 Hz	1.5000 W	Ø12 cm	1,268 Kg

## Sifones

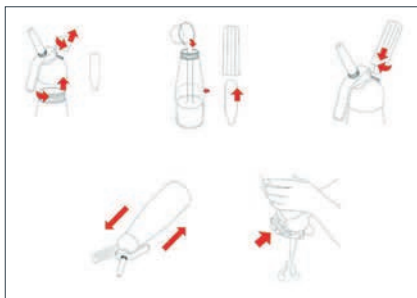

**APTO SOLAMENTE PARA MEZCLAS FRIAS Y TEMPLADAS (<50°C)**

À UTILISER UNIQUEMENT POUR LES MÉLANGES FROIDS ET TREMPÉS (<50°C)

ONLY SUITABLE FOR COLD AND TEMPERED MIXTURES (<50°C)



Realice en segundos purés, mousses, cremas montadas, espumas, salsas y deliciosos postres, un toque de elegancia en la cocina. Ofrece 4 veces más volumen que el volumen líquido.

**NO debe ser empleado con líquidos calientes. NUNCA ponga los sifones al baño maría, puede producirse una explosión con graves consecuencias**

Réalisez en quelques secondes des purées, des mousses, des crèmes montées, des sauces et de délicieux desserts, une touche d'élegance dans la cuisine.

Confère 4 fois plus de volume que le volume liquide  
**NE DOIT PAS** être utilisé avec des liquides chauds. **NE JAMAIS** mettre les siphons au bain marie car une explosion pourrait avoir lieu et provoquer de graves conséquences

Pürees, Mousses, Schlagsahne, Schäume, Saucen und köstliche Desserts im Nu zubereiten, ein Hauch von Eleganz in der Küche  
Vervielfacht das Ausgangsvolumen der Flüssigkeit  
**NICHT** für Verwendung mit heißen Flüssigkeiten geeignet. Gerät **NIE** in Wasserbad legen. Dies kann zu einer folgenschweren Explosion führen

Make purées, mousses, whipped creams, foams, sauces and delicious desserts in seconds. A touch of elegance in the kitchen  
Whips content up to 4 times the liquid volume  
Should **NOT** be used with hot liquids. **NEVER** put siphons in a water bath, as this may cause an explosion with serious consequences

Prepare em segundos purés, mousses, cremes batidos, espumas, molhos e deliciosas sobremesas, dando um toque de elegância à sua cozinha  
Proporciona 4 vezes mais volume do que o volume líquido  
**NÃO** utilizar com líquidos quentes. **NUNCA** coloque os sifões em banho-maria, para evitar o risco de explosão com consequências graves

### Botellas sifón N2O

Cartouches N2O pour siphon  
N2O Sahnkessel-Packung  
N2O cream charger  
Botijas de sifão N2O



Ref	€	Botellas	g	Pack
68402	6,50	10	8	10
68403	15,20	24	8	24

**Cabezal** · Head: Aluminio / Aluminium

**Botella** · Bottle: Inox



### Sifón crema Inox + Cabezal Alum.

Siphon à crème en Inox + alum.  
Sahnbereiter, Rostfrei + alum.  
St. Steel + alum. cream whipper  
Sifão creme Inóx + cabeça alumínio

Ref	€	L	Ø (cm)	Pack
68404	98,00	0,50	7,8x25	1
68405	112,50	1,00	9,3x32,5	1

**Temperatura de uso** · Temperatura de uso  
min = +5°C / max = +50°C

**Cabezal** · Head: Plástico PBT/ PBT Plastic

**Botella** · Bottle: Aluminio / Aluminium



### Sifón crema Aluminio

Siphon à creme en Aluminium  
Sahnbereiter, Aluminium  
Aluminium cream whipper  
Sifão creme Alumínio

Ref	€	Ø (cm)	L	Pack
68502	33,80	9x27	0,25	12
68500	40,10	9x31	0,50	12
68501	44,60	11x36	1,00	12

**Cabezal** · Head: Aluminio / Aluminium

**Botella** · Bottle: Aluminio / Aluminium



### Botella sifón GREEN

Siphon à creme  
Sahnbereiter  
Cream whipper  
Sifão creme

Ref	€	L	Ø (cm)	Pack
68504	42,30	0,5	7,8x27,3	12
68505	46,50	1,0	9,3x32,5	12

**Temperatura de uso** · Temperatura de uso  
min = +5°C / max = +50°C

**Cabezal** · Head: Aluminio / Aluminium

**Botella** · Bottle: Aluminio / Aluminium



### Botella Sifón BLACK

Siphon à creme  
Sahnbereiter  
Cream whipper  
Sifão creme

Ref	€	L	Ø (cm)	Pack
68604	42,30	0,50	7,8x27,3	12
68605	46,50	1,00	9,3x32,5	12

**Temperatura de uso** · Temperatura de uso  
min = +5°C / max = +50°C

## Boquillas

**Fabricadas en acero inoxidable 18/10**

**Excelente resistencia a la corrosión y a los ácidos alimentarios y sales**  
**Adaptables a las mangas de repostería**  
**Distintas formas para decorar postres**

Fabriquéés en acier inoxydable 18/10

Excellente résistance à la corrosion et aux acides et sels alimentaires

Adaptables sur les poches à douilles de pâtisserie

Différentes formes pour décorer les desserts

Aus nicht rostendem 18/10-Stahl hergestellt

Sehr korrosionsbeständig und widerstandsfähig gegen Säure aus Lebensmitteln und Salzen

Passen auf Spritzbeutel

Diverse Formen zur Verzierung von Desserts

Made of 18/10 stainless steel

Excellent resistance to corrosion and to food acids and salts

Can be adapted to piping bags

Different shapes for decorating desserts

Fabricadas em aço inoxidável 18/10

Excelente resistência à corrosão e aos ácidos e sais alimentares

Adaptáveis às mangas de pastelaria

Diferentes formas para decorar sobremesas

**Set de 6 boquillas redonda**

Ensemble 6 douilles unies

Lochtüllensatz 6-tlg.

6 plain tube set

Conjunto de 6 boquilhas redondas



Ref	€	Ø (mm)	Pack
68904	20,00	4	1
68906	20,00	6	1
68908	20,00	8	1
68910	20,00	10	1
68912	20,00	12	1
68915	20,00	15	1

**Set de 6 boquillas estrella**

Ensemble 6 douilles cannelées

Lochtüllensatz 6-tlg.

6 star tube set

Conjunto de 6 boquilhas estrela



Ref	€	Ø (mm)	Pack
68924	20,00	4	1
68926	20,00	6	1
68928	20,00	8	1
68900	20,00	10	1
68932	20,00	12	1
68934	20,00	15	1

**Set de 6 boquillas rosa**

Ensemble 6 douilles cannelées fermes

Tüllensatz 6-tlg., Stern, geschlossen

6 close star tube set

Conjunto de 6 boquilhas rosa



Ref	€	Ø (mm)	Pack
68944	20,00	4	1
68946	20,00	6	1
68948	20,00	8	1
68980	20,00	10	1
68942	20,00	12	1
68985	20,00	15	1

**Set de 6 boquillas cinta estrella**

Ens. 6 douilles à bouche

Tüllensatz 6-tlg., Weihnachtsmotiv

6 yule log tube

Conjunto de 6 boquilhas cinta estrela



Ref	€	Ø (mm)	Pack
68990	20,00	10	1
68918	20,00	18	1
68995	20,00	25	1

**Set de 6 boquillas flor**

Ensemble 6 douille fleur

Tüllensatz 6-tlg., Blume

6 flower tube

Conjunto de 6 boquilhas flor



Ref	€	Ø (mm)	Pack
68914	20,00	4	1
68938	20,00	8	1
68952	20,00	12	1

**Set de 6 boquillas lágrima**

Ensemble 6 douille déchirer

Tüllensatz 6-tlg., Reißen

6 tear tube

Conjunto de 6 boquilhas rasgar



Ref	€	Ø (mm)	Pack
68901	20,00	20	1
68916	20,00	25	1







**Set de 6 boquillas redonda**

Ensemble 6 douilles unies  
Lochtüllensatz 6-tlg.  
6 plain tube set  
Conjunto de 6 boquillas redonda

Ref	€	Forma (mm)
68996	13,80	Redonda 4/5/6/8/10/12



**Set de 6 boquillas estrella**

Ensemble 6 douilles cannelées  
Tüllensatz 6-tlg., Stern  
6 star tube set  
Conjunto de 6 boquillas estrella

Ref	€	Forma (mm)
68997	13,80	Estrella 4/5/6/8/10/12

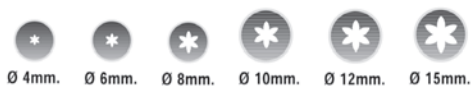

**Set de 6 boquillas rosa**

Ensemble 6 douilles cannelées fermes  
Tüllensatz 6-tlg. Stern, geschlossen  
6 close star tube set  
Conjunto de 6 boquillas rosa

Ref	€	Forma (mm)
68993	13,80	Rosa 4/6/8/10/12/15

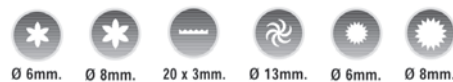

**Set de 6 boq. variadas**

Ens. 6 douilles variées  
Tüllensatz 6-tlg.  
6 assorted tube set  
Conjunto de 6 boquillas variadas

Ref	€	Forma (mm)
68998	13,80	Rosa 6/8
		Cinta 20x3
		Hélice 5
		Estrella 6/9/13



**Set de 6 boquillas variadas**

Ensemble 6 douilles variées  
Tüllensatz 6-tlg.  
6 assorted tube set  
Conjunto de 6 boquillas variadas

Ref	€	Forma (mm)
68999	13,80	Rosa 6/8
		Hélice 5
		Estrella 6/9/13

**Set de 2 boquillas relleno**

Ensemble 2 douilles petit chou  
Einfülltüllensatz 2-tlg.  
2 Bismark tube set  
Conjunto de 2 boquillas relleno

Ref	€	Forma (mm)
68992	9,00	Relleno 4/8



## Boquillas

New



Fabricadas en una sola pieza de acero inoxidable de máxima calidad  
Crea originales flores de glasa o buttercream de forma rápida y sencilla  
Coloca la boquilla en una manga pastelera, rellénala de glasa o buttercream y presiona la manga para que salga la crema por la boquilla

Fabriquées en une seule pièce de acier inoxydable de drande qualité  
Créez des fleurs originales avec du glaçage ou de la crème au beurre de façon rapide et simple

Placez la douille sur une poche à douille destinée à la pâtisserie, remplissez-la de glaçage ou de crème au beurre et appuyez sur la poche pour faire sortir la crème par la douille

Aus hochwertigem Edelstahl in einem Stück gezogen  
Blüten aus Glasur oder Buttercreme schnell und einfach spritzen  
Tülle auf den Spritzbeutel setzen, eingefüllte Glasur oder Buttercreme aus dem Beutel durch die Tülle nach außen drücken

Made in one piece of in high quality stainless steel  
Create original icing or buttercream flowers quickly and easily  
Place the nozzle on a piping bag, fill it with icing or buttercream and squeeze the bag so that the cream comes out of the nozzle

Fabricadas a partir de uma única peça em aço inoxidável de grande qualidade  
Para criar originais flores de açúcar glacê ou de buttercream de forma fácil e rápida  
Coloque a boquilha numa manga de pasteleiro, encha-a de glacê ou buttercream, e pressione a manga para que o creme saia pela boquilha

A



B



## Juego 6 boquillas Rusas

Ensemble 6 douilles Russes  
6-Tlg Russian Tüllensatz  
Set 6 Russian decorating nozzles  
Conjunto 6 boquilhas Russo

	Ref	€	Ø (cm)	h (cm)	Unidades	Pack
A	68892	6,90	3,5	4,2	6	1
B	68893	11,90	3,0	6,2	6	1

Inox

ASA  
Acrylic

## Juego de boquillas decoración

Deuilles assorties décoration  
Dekorieren Tüllensortiment  
Decorating nozzles  
Jogo de boquilhas decoração



## Set 24 pcs. boquillas acrílicas

24 pcs. douilles assorties, acrylique  
24 tlg. Tüllensortiment, Acryl  
24 pcs. acrylic nozzles set  
Conjunto de 24 boquilhas acrílicas



	Ref	€	Piezas	Pack
	68991	13,40	26	6

	Ref	€	Piezas	Pack
	68994	12,10	24	1

## Mangas repostería



**Mangas pasteleras para decorar y personalizar tus postres preferidos**  
**Mangas de alta calidad, soportan altas temperaturas, resistentes y reutilizables**  
**Aptas para el lavavajillas**

Poche à douille pour décorer et personnaliser vos desserts préférés  
 Poche de grande qualité, supporte des températures élevées, résistante et réutilisable  
 Compatible avec le lave-vaisselle

Spritzbeutel zur Dekoration und individuellen Gestaltung deiner Lieblingsnachtsische  
 Spritzbeutel aus qualitativ, beständig auch bei hohen Temperaturen, robust und wiederverwendbar  
 Spülmaschinengeeignet

Pastry bag to decorate and customise your favourite desserts  
 Bag of high-quality withstands high temperatures and is durable and reusable  
 Dishwasher safe

Manga de pasteiro para decorar e personalizar as tuas sobremesas favoritas  
 Manga de alta qualidade, que suporta altas temperaturas, resistente e reutilizável  
 Apta para a máquina de lavar louça

SI PP  
 Silicone Polypropylene



### Manga repostería + 5 boquillas

Poche à décorer + 5 Douilles  
 Spritzbeutel + 5 Tlg. Tüllensortiment  
 Pastry bag + 5 pcs. Nozzles  
 Manga de pasteleria + 5 Boquilhas

Ref	€	ml	h (cm)	Pack
68971	6,10	800	30	12



### Manga repostería + 4 boquillas

Poche à décorer + 4 Douilles  
 Spritzbeutel + 4 Tlg. Tüllensortiment  
 Pastry bag + 4 pcs. Nozzles  
 Manga de pasteleria + 4 Boquilhas

	Ref	€	cm	Ø (cm)	Pack
A	68972	5,90	20	20x30	12
B	68973	9,90	30	25x45	12

PA  
 Nylon

Boca · Mouth: Ø2,5 cms.

### Manga repostería Nylon

Poche à décorer en nylon  
 Nylon Spritzbeutel  
 Nylon pastry bag  
 Manga de pasteleria de nylon

Ref	€	h (cm)	L	Pack
68930	4,10	30	0,57	6
68935	4,80	35	1,10	6
68940	5,30	40	1,45	6
68945	6,30	45	2,30	6
68950	7,00	50	2,50	6
68955	7,60	55	3,40	6
68960	8,60	60	5,50	6
68965	9,10	65	6,50	6
68970	10,90	70	7,50	6

Galga 280 = 70 micras (µm)

### Mangas desechables

Poche à décorer jetable  
 Einweg Spritzbeutel  
 Non-returnable pastry bags  
 Mangas descartaveis



Ref	€	Cantidad	h (cm)	Pack
68939	17,20	100	40	1
68954	25,70	100	55	1
68964	30,10	100	65	1



## Decoración



### Biberón decoración

Biberon à decorer  
Dekorieren dosierflasche  
Decorating pen  
Garrafa decoração



Ref	€	Ø (cm)	ml	Pack
64457	7,00	5,5x16	140	24

SI  
Silicone



SI PP  
Silicone Polypropylene

### Biberón decoración

Biberon à decorer  
Dekorieren dosierflasche  
Decorating pen  
Garrafa decoração



Ref	€	Ø (cm)	ml	Pack
64458	7,10	5x17,5	150	6

SIN BISPHENOL A  
Without Bisphenol A

New

PE PELD  
Polyethylene Polyethylene

ASA  
Acrylic



Polyethylene (PE)

Polyethylene (PELD)



### Botella biberón con boquilla triple

Bouteille biberon avec douille triple  
Dosierflasche mit Dreifachdüse  
Squeeze bottle with triple nozzle  
Garrafa com boquilha triplo

Ref	€	Ø (cm)	ml	Pack
61974	2,70	7x20	472	12
61977	2,90	7x26	708	12

### Pistola repostería

Pistolet pour pâtisserie  
Pistole für Tüllensätze  
Cookie press  
Pistola pasteleria



Ref	€	cm	ml	Pack
61401	9,30	14x5x22,5	240	12

### Pistola decoración repostería

Pistolet Décoration Pâtisserie  
Pistole für Tüllensätze  
Pastry Decoration Gun  
Pistola Decoração Pastelaria



Ref	€	ml	Pack
61407	26,40	250	36

### Juego pistola repostería

Pistolet pour pâtisserie  
Pistole für Tüllensätze  
Cookie press cum icing set  
Jogo de pistola pastelaria



Ref	€	ml	Pack
68989	38,90	250	1

### Baño María chocolate

Bain Marie de chocolat  
Bain Marie topf für Schokolade  
Chocolate Bain Marie  
Banho-Maria Chocolate



Ref	€	Pack
69317	33,20	1

Ref	Tensión/Voltage	Potencia/Power	Temperatura/Temp.	Capacidad/Capacity	Dimensiones/Sizes	Peso/Weight
69317	230-240 V / 50-60 Hz	50 W	40-50°C	1,0 L (max)	29x22x12 cm	0,875 Kg





**Rejilla de alambre resistente para dejar reposar los postres recién sacados del horno o cubrir de chocolate o azúcar glass**  
**Fabricada en acero cromado para una larga duración**  
**Los pies permiten que se seque el fondo de los postres**  
**Protege las superficies de la cocina de quemaduras**  
**No se recomienda su uso en el lavavajillas**

Grille de refroidissement en métal pour laisser reposer les desserts fraîchement sortis du four ou les napper de chocolat ou de sucre glace  
 Fabriquée en acier chromé pour une grande durabilité  
 Ses pieds permettent à la base des desserts de sécher  
 Protège les surfaces de la cuisine des brûlures  
 Lavage au lave-vaisselle déconseillé

Robustes Kuchenrost zum Ablegen der ofenfrischen Backwaren oder zum Auftragen einer Schokoladenglasur oder von Puderzucker  
 Aus widerstandsfähigem, verchromtem Stahl  
 Aufgrund der Füße können die Unterseiten der Backwaren aushärten  
 Schützt die Oberfläche der Küchenplatte vor Verbrennungen  
 Nicht im Geschirrspüler reinigen

Resistant wire rack for cooling freshly baked desserts or covering them in chocolate or sugar glass  
 Made of chrome steel for a long life  
 Its feet enable you to dry the bottom of your desserts  
 Protects kitchen surfaces from burns  
 Dishwasher not recommended

Grelha de arame resistente para deixar repousar as sobremesas que se acabam de retirar do forno ou para cobrir com chocolate ou açúcar glace  
 Fabricada em aço cromado para uma longa duração  
 Os seus pés permitem que o fundo das sobremesas seque  
 Protege de queimaduras as superfícies da cozinha  
 Não se recomenda máquina de lavar louça



**Rejilla para repostería**

Grille pâtisserie  
 Grillpfanne für Tullensätze  
 Pastry rack  
 Grelha para pasteleria

Ref	€	Ø (cm)	Pack
66926	4,70	32	1



**Marcador de tartas**

Marqueur à gateaux  
 Tortenteiler  
 Cake marker  
 Marcador de bolos

Ref	€	Ø (cm)	Porciones	Pack
68511	7,10	27	10-12	12
68513	7,10	27	14-16	12



**Pinza repostería**

Pince à gateau  
 Gebäck-Tortenzange  
 Cake tong  
 Pinça pastelaria

Ref	€	L (cm)	Pack
62317	9,50	20	12



**Pinza repostería con anillas**

Pince à gateau avec anneaux  
 Gebäckzange  
 Cake tong with rings  
 Pinça pastelaria com anilhas

Ref	€	L (cm)	Pack
68008	4,70	16	6



**Portartas**

Gueridon pâtisier  
 Kuchenplatte  
 Cake stand  
 Porta-tartes

Ref	€	Ø (cm)	Pack
67030	139,60	30	1



**Portartas**

uéridon pâtisserie  
 Kuchenplatte  
 Cake stand  
 Porta-tartes

Ref	€	cm	Pack
63586	25,70	33x9	4



**Copa baja**

Coupe à glace basse  
 Eiskelch  
 Ice cream cup  
 Taça de gelado

Ref	€	Bolas	Ø (cm)	Pack
67002	3,90	5,5	9x12	6

## Racionadores

**Racionador Profesional**

Cuillère à glace professionnel  
Eisportionierer, Profi  
Professional ice cream scoop  
Racionador Profesional



Ref	€	Bolas	mm	Pack
67038	26,90	50	39	10
67043	26,90	40	44	10
67045	27,60	36	46	10
67047	27,60	30	48	10
67049	27,60	24	50	10
67052	28,50	20	53	10
67055	28,50	16	56	10
67058	28,50	13	59	10
67062	28,50	12	63	10
67065	28,50	10	66	10
67069	28,40	8	70	10
67074	28,40	7	75	10
67084	28,40	5	85	10

**Racionador Helado**

Cuillère à glace  
Eisportionierer  
Ice cream scoop  
Racionador de gelado



Ref	€	Bolas	mm	Pack
67039	14,20	50	39	10
67044	14,20	40	44	10
67046	14,20	36	46	10
67048	14,20	30	48	10
67050	14,20	24	50	10
67053	14,50	20	53	10
67056	15,10	16	56	10
67059	15,10	13	59	10
67063	15,10	12	63	10
67066	15,40	10	66	10
67070	15,40	8	70	10

**Racionador Profesional Oval**

Cuillère à glace luxe ovale  
Eisportionierer, Profi  
Ice cream scoop luxe oval  
Racionador oval Professional



Ref	€	Bolas	mm	Pack
67153	28,40	40	53x41	10
67158	28,40	30	58x48	10
67163	28,40	20	63x48	10

**Racionador helado Aluminio**

Cuillère à glace Aluminium  
Eisportionierer, Aluminium  
Aluminium ice cream scoop  
Racionador de gelado Aluminio

AL  
Aluminium

Ref	€	Bolas	mm	L (cm)
67090	7,80	50	50	18

**Racionador Helado**

Cuillère à glace  
Eisportionierer  
Ice cream scoop  
Racionador de gelado

	Ref	€	L (cm)	Color	Pack
<b>A</b>	64474	139,40		Caja / Display (25 pcs)	1
<b>B</b>	64472	5,70	18	Naranja / Orange	12
<b>C</b>	64473	5,70	18	Rojo / Red	12
<b>D</b>	64475	5,70	18	Azul / Blue	12
<b>E</b>	64476	5,70	18	Verde / Green	12
<b>F</b>	64477	5,70	18	Morado / Purple	12

**A****B****C****D****E****F**ZAMAK  
Zinc alloy

Moldes - Aros  
Moulds - Cake Rings

#CocinaConLacor





## Moldes Black



### Briolette 24 cavidades

Briolette 24 cavités  
Briocheform für 24 Madaleine  
Briolette 24 moulds  
Briolette 24 cavidades



Ref	€	Ø (mm)	h (mm)	ml
66760	78,30	79	35	84



### Semiesférica 28 cavidades

Hemispher 28 cavités  
Halbkugelform für 28 Madaleine  
Half-spheres 28 moulds  
Semi-esférica 28 cavidades



Ref	€	Ø (mm)	h (mm)	ml
66761	78,30	70	35	90

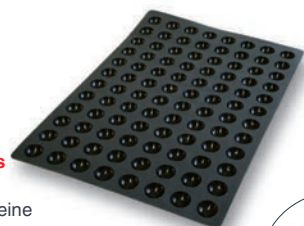

### Mini semiesférica 96 cavidades

Mini Hemispher 96 cavités  
Mini Halbkugelform für 96 Madaleine  
Mini Half-spheres 96 moulds  
Mini semi-esférica 96 cavidades



Ref	€	Ø (mm)	h (mm)	ml
66762	78,30	35	11,70	11



### Madalena 44 cavidades

Madeleine 44 cavités  
Madeleineform für 44 Madaleine  
Madeleine 44 moulds  
Madalena 44 cavidades



Ref	€	Ø (mm)	h (mm)	ml
66763	78,30	77x44,5	18	32

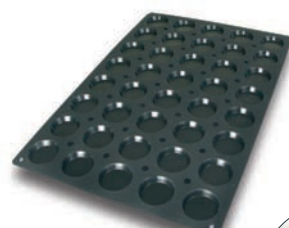

### Florentina 40 cavidades

Florentine 40 cavités  
Florentinerform für 40 Madaleine  
Florentina 40 moulds  
Florentina 40 cavidades



Ref	€	Ø (mm)	h (mm)	ml
66764	78,30	60	11	25

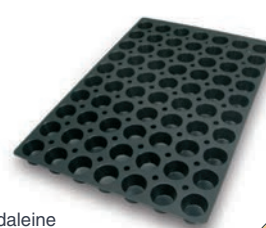

### Mini muffin 70 cavidades

Mini muffin 70 cavités  
Mini Muffinform klein für 70 Madaleine  
Mini muffin 70 moulds  
Mini muffin 70 cavidades



Ref	€	Ø (mm)	h (mm)	ml
66765	78,30	45	30	40



### Muffin 24 cavidades

Muffin 24 cavités  
Muffinform für 24 Madaleine  
Muffin 24 moulds  
Muffin 24 cavidades



Ref	€	Ø (mm)	h (mm)	ml
66766	78,30	69	39	122

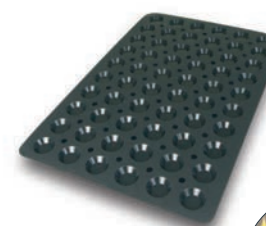

### Tartaleta 60 cavidades

Tartalette 60 cavités  
Torteiteform für 60 Madaleine  
Tartlet 60 moulds  
Tarte 60 cavidades



Ref	€	Ø (mm)	h (mm)	ml
66767	78,30	44	10	10

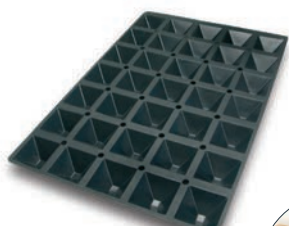

### Piramide 35 cavidades

Pyramide 35 cavités  
Pyramidenform für 35 Madaleine  
Pyramid 35 moulds  
Pirâmide 35 cavidades



Ref	€	Ø (mm)	h (mm)	ml
66768	78,30	65x65	35	61

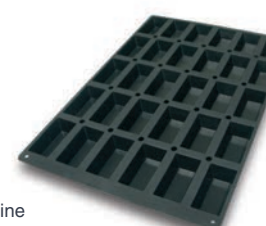

### Mini cake 30 cavidades

Mini cake 30 cavités  
Mini Kuchenform für 30 Madaleine  
Mini cake 30 moulds  
Mini cake 30 cavidades



Ref	€	Ø (mm)	h (mm)	ml
66769	78,30	99x49	30	110



# Pastryflex

El precio corresponde a la unidad de embalaje

Le prix est par pièce d'emballage

Preise für Verpackungslinheit

Prices are for packing unit

O preço corresponde a unidade de embalagem

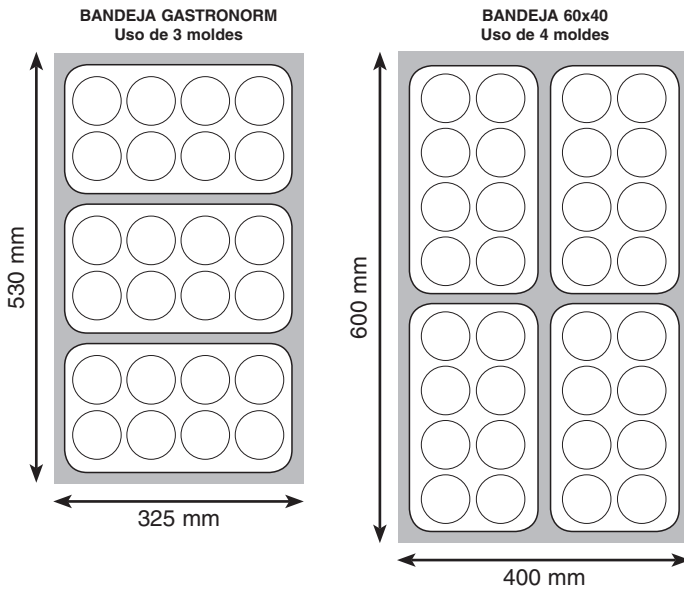

Dimensiones / Sizes

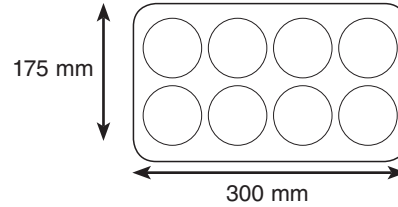

### Cilindro mediano 11 cavidades

Cylindre moyen 11 cavités  
Zylinderform, mittelgross für 11 Madeleine  
Medium cylindre 11 moulds  
Cilindro médio 11 cavidades



Ref	€	Ø (mm)	h (mm)	Pack
66812	12,40	45	48	1

### Cilindro grande 8 cavidades

Grand cylindre 8 cavités  
Zylinderform, gross für 8 Madeleine  
Large cylindre 8 moulds  
Cilindro grande 8 cavidades



Ref	€	Ø (mm)	h (mm)	Pack
66813	12,40	55	60	1

### Cilindro 8 cavidades

Cylindre 8 cavités  
Zylinderform für 8 Madeleine  
Cylindre 8 moulds  
Cilindro 8 cavidades



Ref	€	Ø (mm)	h (mm)	Pack
66807	12,40	60	35	1

### Madalena pequeña 15 cavidades

Petite madeleine 15 cavités  
Madeleineform, Klein, für 15 Madeleine  
Small madeleine 15 moulds  
Madalena pequena 15 cavidades



Ref	€	Ø (mm)	h (mm)	Pack
66816	12,40	42x30	11,5	1

### Madalena 9 cavidades

Madeline 9 cavités  
Madeleineform 9 Madeleine  
Madeline 9 moulds  
Madalena 9 cavidades

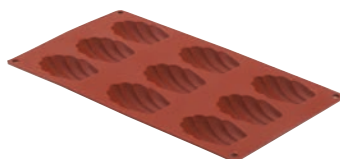

Ref	€	Ø (mm)	h (mm)	Pack
66817	12,40	78x45	17	1

### Brioche 6 cavidades

Brioche 6 cavités  
Briocheform 6 Madeleine  
Brioche 6 moulds  
Brioche 6 cavidades

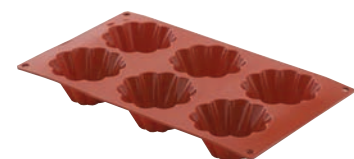

Ref	€	Ø (mm)	h (mm)	Pack
66819	12,40	103	20	1

**Brioche 6 cavidades**

Brioche 6 cavités  
Briocheform 6 Madeleine  
Brioche 6 moulds  
Brioche 6 cavidades



Ref	€	Ø (mm)	h (mm)	Pack
66820	12,40	79	30	1

**Semiesférica 24 cavidades**

Hemispher 24 cavités  
Halbkugelform 24 Madeleine  
Half-spheres 24 moulds  
Semi-esférica 24 cavidades



Ref	€	Ø (mm)	h (mm)	Pack
66800	12,40	30	17	1

**Semiesférica 15 cavidades**

Hemispher 15 cavités  
Halbkugelform 15 Madeleine  
Half-spheres 15 moulds  
Semi-esférica 15 cavidades



Ref	€	Ø (mm)	h (mm)	Pack
66801	12,40	40	20	1

**Semiesférica 6 cavidades**

Hemispher 6 cavités  
Halbkugelform 6 Madeleine  
Half-spheres 6 moulds  
Semi-esférica 6 cavidades



Ref	€	Ø (mm)	h (mm)	Pack
66802	12,40	70	35	1

**Piramide 15 cavidades**

Pyramide 15 cavités  
pyramideform 15 Madeleine  
Pyramid 15 moulds  
Pirâmide 15 cavidades



Ref	€	Ø (mm)	h (mm)	Pack
66821	12,40	36	22	1

**Piramide 6 cavidades**

Pyramide 6 cavités  
Pyramideform 6 Madeleine  
Pyramid 6 moulds  
Pirâmide 6 cavidades



Ref	€	Ø (mm)	h (mm)	Pack
66822	12,40	71	41	1

**Ovalo 16 cavidades**

Ovale 16 cavités  
Ovale Form 16 Madeleine  
Oval 16 moulds  
Oval 16 cavidades



Ref	€	Ø (mm)	h (mm)	Pack
66823	12,40	53x33	20	1

**Muffin 6 cavidades**

Muffin 6 cavités  
Muffinform 6 Madeleine  
Muffin 6 moulds  
Muffin 6 cavidades



Ref	€	Ø (mm)	h (mm)	Pack
66805	12,40	70	40	1

**Mini muffin 11 cavidades**

Mini muffin 11 cavités  
Muffinform klein für 11 Madeleine  
Mini muffin 11 moulds  
Mini muffin 11 cavidades



Ref	€	Ø (mm)	h (mm)	Pack
66804	12,40	50	28	1

**Corazón 8 cavidades**

Coeur 8 cavités  
Herzform 8 Madeleine  
Heart 8 moulds  
Coração 8 cavidades



Ref	€	Ø (mm)	h (mm)	Pack
66824	12,40	65x60	35	1

**Rectángulo pequeño 20 cavidades**

Petit rectangle 20 cavités  
Form rechteckig für 20 Madeleine  
Petit-four 20 moulds  
Rectángulo pequeno 20 cavidades



Ref	€	Ø (mm)	h (mm)	Pack
66825	12,40	49x26	11	1

**Cake 12 cavidades**

Cake 12 cavités  
Kuchenform 12 Madeleine  
Cake 12 moulds  
Cake 12 cavidades

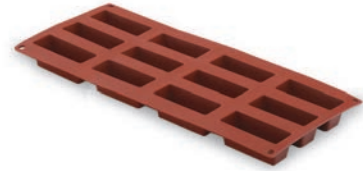

Ref	€	Ø (mm)	h (mm)	Pack
66826	12,40	80x30	30	1

**Petit four 15 cavidades**

Petit four 15 cavités  
Petits Fours 15 Madeleine  
Petit four 15 moulds  
Petit four 15 cavidades

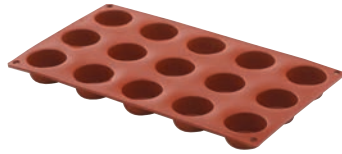

Ref	€	Ø (mm)	h (mm)	Pack
66827	12,40	40	20	1

**Pomponette 24 cavidades**

Pomponette 24 cavités  
Pomponetteform 24 Madeleine  
Pomponette 24 moulds  
Pomponette 24 cavidades

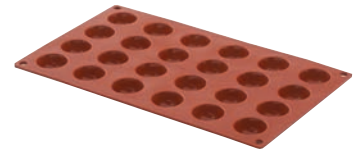

Ref	€	Ø (mm)	h (mm)	Pack
66828	12,40	34	16	1

**Mini savarin 15 cavidades**

Mini savarin 15 cavités  
Savarinform 15 Madeleine  
Mini savarin 15 moulds  
Mini savarin 15 cavidades



Ref	€	Ø (mm)	h (mm)	Pack
66808	12,40	41	12	1

**Base esponjosa 3 cavidades**

Base spongieuse 3 cavités  
Keksform für 3 Madeleine  
Sponge base 3 moulds  
Base esponjosa 3 cavidades



Ref	€	Ø (mm)	h (mm)	Pack
66830	12,40	103	20	1

**Mini bordelais 18 cavidades**

Mini bordelais 18 cavités  
Mini Bordelaisform 18 Madeleine  
Mini bordelais 18 moulds  
Mini bordelais 18 cavidades



Ref	€	Ø (mm)	h (mm)	Pack
66844	12,40	25	30	1

Con anilla de refuerzo  
With a reinforced ring



**Molde Cake**

Moule à cake  
Kuchenform  
Cake mould  
Molde cake

Ref	€	cm	Pack
66733	17,20	24x10x6,5	1
66742	18,90	28x10x7,0	1

Con anilla de refuerzo  
With a reinforced ring



**Molde savarin bajo**

Moule Savarin bas  
Savarinform, klein  
Low Savarin mould  
Molde pudin baixo

Ref	€	Ø (cm)	h (mm)	Pack
66734	17,40	23	6,0	1

**Molde de flan 6 cav.**

Moule à flan 6 cabités  
Madeleine Backform für 6 Madeleine  
Creme caramel 6 moulds  
Molde de flan 6 cavidades



Ref	€	cm	Pack
66736	17,40	29x19x5	1

Con anilla de refuerzo  
With a reinforced ring



**Molde savarin alto**

Moule Savarin haut  
Savarinform, gross  
High Savarin mould  
Molde pudin alto

Ref	€	Ø (cm)	h (mm)	Pack
66735	19,00	23	10,50	1

Con anilla de refuerzo  
With a reinforced ring



**Molde redondo**

Moule à manque  
Tortenform  
Round cake mould  
Molde redondo

Ref	€	Ø (cm)	h (mm)	Pack
66737	17,00	24	4,5	1
66738	17,40	26	4,5	1

Con anilla de refuerzo  
With a reinforced ring



**Molde de tarta**

Moule à tarte tatin  
Tortenform  
Tart mould  
Molde de tarte

Ref	€	Ø (cm)	h (mm)	Pack
66739	22,60	29	3,50	1

Con anilla de refuerzo  
With a reinforced ring



**Molde corazón**

Moule coeur  
Herzform  
Heart mould  
Molde coração

Ref	€	cm	Pack
66741	16,20	23x18,5x4	1



## Moldes Desmontables Silicona



**Molde 100% silicona antiadherente a prueba de goteo**  
**Base de cristal con recubrimiento antiadherente y antirrayado, resistente a cortes**  
**Perfecto para presentar en la mesa sobre la misma base**  
**Sistema de cierre seguro antiderrame. Ideal para pasteles y tartas delicadas**

Moule 100% silicone antiadhésif à l'épreuve de l'égouttement  
 Base en verre avec revêtement antiadhésif et anti-rayures, résistant aux coupures  
 Parfait pour une présentation à table sur la même base  
 Syst.de fermeture sûr et anti-écoulement. Idéal pour les gâteaux et les tartes délicates

Nicht tropfende Form aus 100% Silikon mit Antihftbeschichtung  
 Glasplatte mit Antihftbeschichtung, kratz- und schnittfest  
 Eignet sich perfekt, um diese direkt auf der Glasplatte zu servieren  
 Sicheres Verschlussystem mit Auslaufschutz. Ideal für leicht zerbrechliche Kuchen und Torten

Non-stick, drip-proof 100% silicone mould  
 Glass base with non-stick, anti-scratch and cut-resistant coating  
 Perfect for presenting at the table on its base  
 Secure anti-spill locking system. Ideal for delicate cakes and tarts

Molde 100% de silicone antiaderente à prova de gotejo  
 Base de vidro com revestimento antiaderente e antirriscos, resistente aos cortes  
 Preferito para servir à mesa, sobre a própria base  
 Sistema de fecho seguro antiderrame. Ideal para pastéis e tartes delicadas



**Cerrar molde con pinza de sujeción**

Fermer le moule avec une pince de fixation  
 Form mit Befestigungsklammer schließen  
 Close mould with fastening clamp  
 Fechar o molde com a pinça de sujeição



**Verter masa en silicona a prueba de goteo**

Verser pâte dans silicone à l'épreuve de l'égouttement  
 Masse in tropffreies Silikon geben  
 Pour dough in leak-proof silicone  
 Verter a massa em silicone à prova de gotejo



**Se desmolda con suma facilidad, flexible**

Démoulable très facilement, flexible  
 Sehr leichte Entformung, flexibel  
 Easily removed from mould, flexible  
 Desmolda-se facilmente. Flexível



**Base de cristal antiadherente y antirayadura**  
 Glass base non stick and



**Molde desmontable redondo**

Moule demontable à manque  
 Demontierbar schimmel, Rund  
 Round dismantable mould  
 Molde desmontável redondo



Ref	€	Ø (cm)	L	Pack
66775	16,20	25x7,5	2,0	6



**Molde desmontable cake**

Moule demontable à cake  
 Demontierbar schimmel, Cake  
 Cake dismantable mould  
 Molde desmontável cake



Ref	€	cm	L	Pack
66776	15,70	29x13x7	1,5	6



**Molde desmontable cuadrado**

Moule demontable à carré  
 Demontierbar schimmel, vierecking  
 Square dismantable mould  
 Molde desmontável quadrado



Ref	€	cm	L	Pack
66777	18,30	25x25x7,5	2,5	6

## Moldes silicona



### Set 12 moldes Muffin silicona

Set 12 moules Muffin en silicone  
Set 12 Muffin formen, Silikon  
Silicone 12 muffin moulds set  
Conjunto 12 moldes Muffin en silicone



-40°C  
220°C



30 macarons -> 5cm  
48 macarons -> 4cm



### Molde macarons doble

moule macarons double  
Doppel Macaronsform  
Macarons dual mould  
Molde macarons duplo

Ref	€	Ø (cm)	Pack
66745	4,10	7x5	1

Ref	€	cm	Pack
66753	8,70	39x29	6

### Flexible, antiadherente y reutilizable

Flexible, anti-adhérente et réutilisable  
Flexible, Antihaft- und wiederverwendbar  
Flexible, non-stick and reusable  
Flexibel, antiaderente e reutilizável

### Incluye - Includes:

- 1.- Tablas de conversión de temperatura (°C / °F)
- 2.- Peso (gr / oz)
- 3.- Volumen ml / fl oz / pt
- 4.- Longitud (mm / inch)
- 5.- Reglas laterales (cm / inch)



### Tapete de silicona

Tapis en silicone  
Backblech-Auflage Silikon  
Silicone covering  
Tapete de silicone

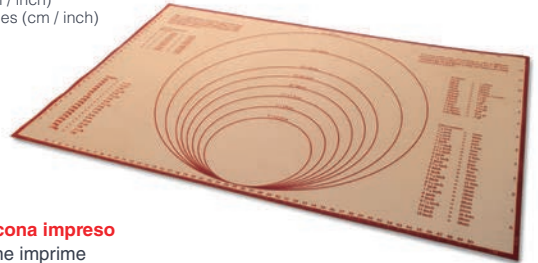

### Tapete de silicona impreso

Tapis en silicone imprime  
Gedruckt Silikonmatte  
Printed silicon mat  
Tapete de silicone impreso

Ref	€	cm	Pack
66749	16,40	30x40	1
66731	23,80	60x40	1
66732	17,60	52x32 GN 1/1	1

**New**

Ref	€	cm	Pack
66759	23,40	60x40	12



### Láminas antiadherentes

Feuilles antiadhésif  
Antihaft-Blätter  
Non-stick sheets  
Lâminas antiaderentes

**New** Fibra de vidrio Fibreglass ECO PFOA free Healthy Cooking

**Láminas de fibra de vidrio con recubrimiento antiadherente PTFE (Tefex) de gran calidad**  
Ideal para colocar sobre bandejas o parrillas de hornos y deshidratadores  
Vida útil aproximadamente de 1000 horneados  
Diseñadas para soportar temperaturas de hasta 250°C  
Recortable para adaptar a cualquier recipiente  
Reutilizables, para una correcta conservación se recomienda su lavado a mano  
No aptas para lavavajillas

Fibreglass sheets with non-stick coating high-quality PTFE (teflex)  
Ideal for placing on baking trays, oven racks and dehydrators  
Can be used approximately 1,000 times  
Designed to withstand temperatures up to 250°C  
Can be cut to fit any container  
Reusable; in order to keep the sheets in good condition, we recommend washing by hand  
Non-dishwasher safe

Ref	€	cm	unidades	Pack
66746	7,30	30x40	3	1



### Molde de silicona Baguette

Plaque à pain long en silicone  
Silikonbaguetteform  
Silicone Mould for long bread  
Molde silicone baguette

Ref	€	cm	Cavidades	Pack
67105	65,50	60x40	5	1

Fabricado en fibra de vidrio, impregnado y revestido de silicona (según legislación Europea y Americana)

Apto para el uso ultra congelación, fermentación y cocción de masa y pastas

These molds are made of fiberglass filled and coated with silicon in accordance with European and American legislation  
Apt for freezing at ultralow temperatures, fermentation and for the baking of doughs and pastries

SI Silicone -40°C Min. 280°C Max.

## Placas horno

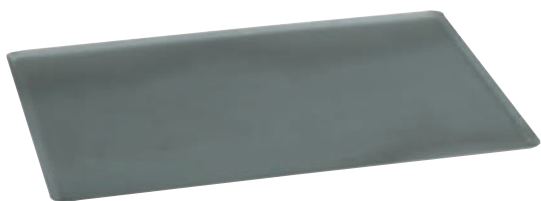

### Placa Horno acero negro

Plaque à four tole noire  
Backblech, Schwarzstahl  
Baking sheet black steel  
Placa de forno aço negro

Ref	€	cm	h (cm)	Pack
68640	29,60	60x40	0,8	1



### Placa horno aluminio antiadherente

Plaque à four aluminium anti-adhesif teflon  
Backblech, Aluminium, Teflon  
Teflon non-stick coated oven aluminium tray  
Placa forno alumínio anti-aderente

Ref	€	cm	h (cm)	Pack
68660	28,80	60x40	1,0	1



### Placa Horno Aluminio

Plaque à four aluminium  
Backblech, Aluminium  
Baking sheet aluminium  
Placa de forno alumínio

Ref	€	cm	h (cm)	Pack
68641	27,40	60x40	0,8	1

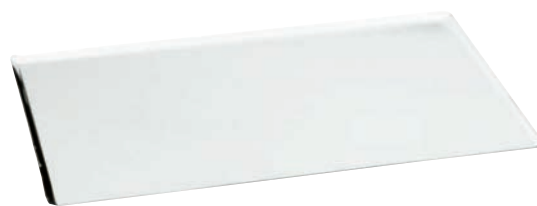

### Placa Horno Inox 18%

Plaque à four inox 18%  
Backblech, Edelstahl 18%  
Baking sheet s. steel 18%  
Placa de forno inox 18%

Ref	€	cm	h (cm)	Pack
68740	35,10	60x40	0,8	1

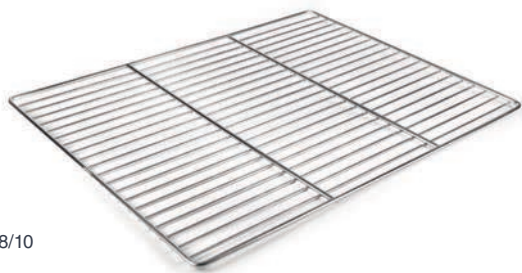

### Parrilla Inox 18/10

Grille inox 18/10  
Grillpfanne, Rostfrei18/10  
Grate s. steel 18/10  
Grelha Inóx 18/10

Ref	€	cm	h (cm)	Pack
68741	24,50	60x40	0,8	1

## Moldes Inox



### Molde cake liso Inox 18% Cr.

Moule à cake inox 18% Cr.  
Pastetenform Rostfrei 18%/ Cr.  
Cake mould s.steel 18% Cr. plain  
Molde cake liso Inóx 18% Cr.

Ref	€	cm	h (cm)	Pack
65925	12,90	25x12	8,5	6
65930	15,50	30x12	8,5	6
65935	18,00	35x12	8,5	6

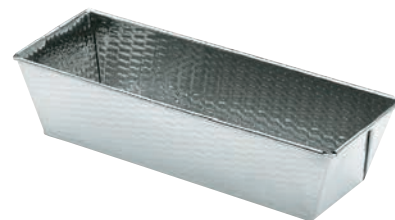

### Molde cake Inox 18% Cr.

Moule à cake inox 18% Cr.  
Pastetenform Edelstahl 18% Cr.  
Cake mould s.steel 18% Cr.  
Molde cake Inóx 18% Cr.

Ref	€	cm	h (cm)	Pack
68726	12,40	25x12	8,5	6
68731	15,00	30x12	8,5	6
68736	17,80	35x12	8,5	6



### Molde 1/2 caña desmontable redondo Inox 18/10

Gouttière à bûche Inox 18/10  
Terrinen-/Kuchenform "Dachrinne", Rostfrei 18/10  
Round cake mould s. steel 18/10  
Molde 1/2 cana desmontável redondo Inóx 18/10

Ref	€	cm	h (cm)	Pack
68001	32,30	25x9	6,0	1
68002	40,50	50x9	6,0	1



### Molde 1/2 caña desmontable triangular Inox 18/10

Moule triangle "demie canne" Inox 18/10  
Terrinen-/Kuchenform "Dachrinne", Edelstahl 18/10  
Three-cornered cake mould s. steel 18/10  
Molde 1/2 cana desmontável rtriangular Inóx 18/10

Ref	€	cm	h (cm)	Pack
68003	32,00	25x9	6,0	1
68004	40,00	50x9	7,0	1

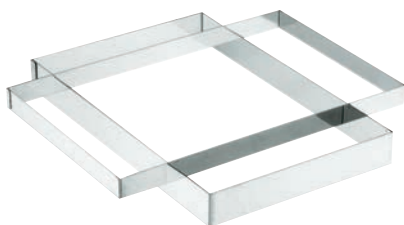

### Marco rectangular Inox 18/10

Rectangle inox 18/10  
Rahmen, rechteckig, Rostfrei 18/10  
Rectangular frame s. steel 18/10  
Molde rectangular Inóx 18/10

Ref	€	cm	h (cm)	Pack
68043	25,00	30x40	3,0	1
68048	25,20	31x48	3,0	1
68060	27,50	40x60	3,0	1
68041	25,20	30x40	5,0	1
68049	26,30	31x48	5,0	1
68061	28,50	40x60	5,0	1



### Bandeja Inox 18/10

Plaque inox 18/10  
Backblech, Rostfrei 18/10  
Baking sheet s. steel 18/10  
Bandeja inóx 18/10

Ref	€	cm	h (cm)	Pack
68030	32,60	30x40	1,0	1
68031	33,00	31x48	1,0	1
68040	58,20	40x60	1,0	1

### Flanero Inox 18/10

Moule à flan Inox 18/10  
Pudding-/Becherförmchen, Rostfrei 18/10  
Pudding mould, st steel 18/10  
Forma flan Inóx 18/10



Ref	€	Ø (cm)	h (cm)	Pack
60006	2,80	6	4,3	12
60007	3,30	7	5,0	10
60008	4,00	8	5,3	10



### Cadena repostería Inox 18/10

Chaîne pour pâtisserie inox 18/10  
Kette für Tüllensätze, Edelstahl 18/10  
St steel 18/10String for pastry  
Corrente para pastelería en Inóx 18/10

Ref	€	L (m)	Pack
68248	9,30	1,80	6





## Moldes Aluminio



**Amplia gama de moldes de aluminio con antiadherente para horno**  
**Resistente a altas temperaturas, excelente conductor de calor**  
**Recubrimiento antiadherente por toda la superficie de la pieza**  
**Ligeros y cómodos de usar**

Large gamme de moules pour four en aluminium avec antiadhésif  
 Résistant à de hautes températures, excellent conducteur de chaleur  
 Revêtement antiadhésif sur toute la surface de la pièce  
 Légers et pratiques à utiliser

Große Bandbreite von backofenfesten Aluminiumformen mit Antihaftbeschichtung  
 Hitzebeständig, erstklassige Wärmeleitung Schnell und gleichmäßig  
 Rundum-Antihaftbeschichtung  
 Leicht und unkompliziert im Gebrauch

Wide range of non-stick aluminium moulds for the oven  
 Resistant to high temperatures, excellent heat conductor  
 The entire surface of the mould has a non-stick coating  
 Lightweight and easy to use

Ampla gama de moldes de alumínio antiaderente para fornos  
 Resistentes a altas temperaturas, com ótima condutividade do calor  
 Revestimento antiaderente em toda a superfície da peça  
 Leves e práticos de utilizar

### Molde cake

Moule à cake aluminium  
 Kuchenform, konisch, Aluminium  
 Cake mould, aluminium  
 Molde cake alumínio



Ref	€	L (cm)	h (cm)	Pack
68825	9,60	25	7	6
68831	11,10	30	7	6
68835	11,60	35	7	6

### Molde rizado movil aluminio

Moule à tarte fond mobile aluminium  
 Kuchenform, konisch, Aluminium  
 Fruit tart mould, aluminium  
 Molde frizado-fundo móvel em alumínio



Ref	€	Ø (cm)	h (cm)	Pack
68842	9,70	24	3	6
68882	12,60	28	3	6
68823	15,70	32	3	6

### Molde alto aluminio

Moule à manque aluminium  
 Käsekuchenform, Aluminium  
 Pie mould, aluminium  
 Molde alto alumínio



Ref	€	Ø (cm)	h (cm)	Pack
68822	8,00	22	4,7	6
68827	8,60	26	5,0	6
68829	10,10	30	5,0	6
68833	11,10	32	5,2	6

### Molde rizado aluminio

Moule à brioche aluminium  
 Briocheform, Aluminium  
 Brioche mould, aluminium  
 Molde flan frizado alumínio



Ref	€	Ø (cm)	h (cm)	Pack
68810	4,20	10	4,0	6
68814	5,70	14	5,5	6
68818	6,30	18	6,5	6
68821	8,60	22	10	6

### Molde pizza aluminio

Moule à pizza aluminium  
 Pizzablech, Aluminium  
 Pizza mould, aluminium  
 Molde pizza alumínio



Ref	€	Ø (cm)	h (cm)	Pack
68824	7,70	24	1,8	6
68828	8,20	28	1,8	6
68832	9,80	32	2,0	6
68836	11,30	36	2,0	6

### Molde pizza aluminio perforado

Moule à pizza aluminium, perforé  
 Pizzablech, Aluminium gelocht  
 Perforated aluminium Pizza mould  
 Molde pizza alumínio perforado



Ref	€	Ø (cm)	h (cm)	Pack
67824	8,60	24	1,8	6
67828	9,40	28	1,8	6
67832	10,10	32	2,0	6
67836	10,70	36	2,0	6

**Molde rizado aluminio**

Moule à tarte fond fixe aluminium  
Tortenbodenform, gewellter Rand, Alum.  
Tart mould, aluminium  
Molde frizado aluminio



Ref	€	Ø (cm)	h (cm)	Pack
68723	8,10	24	3,7	6
68729	9,30	28	3,7	6
68732	10,10	32	3,7	6

**Molde savarin aluminio**

Moule à Savarin aluminium  
Reisrand/Savarinform, Aluminium  
Savarin mould, aluminium  
Molde pudim em alumínio



Ref	€	Ø (cm)	h (cm)	Pack
68724	12,80	24x6,5	5,7	6
68862	14,20	26x6,5	6,0	6
68863	14,00	28x6,5	6,0	6

**Set 4 flaneros aluminio**

Jeu 4 Moule à flan aluminium  
4 Pudding-/Becherförmchen, Aluminium  
4 pcs. pudding mould, aluminium  
Conjunto 4 formas flan aluminio



Ref	€	Ø (cm)	h (cm)	Pack
68808	10,70	8	5,2	4

**Flanero Aluminio**

Moule à flan aluminium  
Pudding-/Becherförmchen, Aluminium  
Pudding mould, aluminium  
Forma flan aluminio



Ref	€	Ø (cm)	h (cm)	Pack
12406	1,10	6	4,9	12
12407	1,20	7	4,9	12
12408	1,30	8	5,0	12

## Moldes Acero Carbono



**Ideal para preparar todo tipo de postres, pudding, gelatinas o mousses, frios o calientes**  
**Fabricados en acero al carbono de gran espesor**  
**Revestimiento antiadherente de gran calidad sin PFOA en el interior y el exterior**  
**Distribuyen el calor de manera uniforme**  
**Asas de silicona resistentes al calor. Apto para hornos hasta 240°C**  
**No se recomiendan lavarlos en el lavavajillas**

Ideal pour préparer tout type de desserts, puddings, gélatines ou mousses, froids ou chauds.

Fabriqués en acier au carbone de grande épaisseur

Revêtement antiadhésif de grande qualité sans PFOA à l'intérieur et à l'extérieur

Distribue uniformément la chaleur

Poignées en silicone résistantes à la chaleur. Compatible avec les fours jusqu'à 240°C

Il est déconseillé de le laver au lave-vaisselle

Ideal für alle Arten von Nachtisch, Pudding, Gelatine oder Mousse - kalt und warm

Aus extra dickem Carbonstahl hergestellt

Qualitätsvolle Antihafbeschichtung ohne PFOA auf Innen- und Außenseite

Gleichmäßige Wärmeverteilung

Hitzebeständige Silikongriffe Backofenfest bis 240°C

Vom Waschen in der Maschine wird abgeraten

Ideal for making all types of hot or cold desserts, puddings, jellies or mousses

Made of thick carbon steel

High quality PFOA-free non-stick coating on the inside and outside

Distributes heat evenly

Heat-resistant silicone handles. Suitable for ovens up to 240°C

Dishwasher use is not recommended

Ideal para preparar todo o tipo de sobremesas, pudins, gelatinas ou mousses, frias ou quentes

Fabricados em aço ao carbono de grande espessura

Revestimento antiaderente de grande qualidade, sem PFOA no interior e no exterior

Distribuição uniforme do calor

Asas de silicone resistentes ao calor. Aptos para fornos até 240 °C

Não é recomendável lavá-los na máquina de lavar louça



### Molde Cake

Moule à Cake

Kuchenform

Cake mould

Molde Cake

Ref	€	cm	L	Pack
68750	10,70	31x15,5x8	1,50	1



### Molde redondo

Moule à manqué

Tortenform

Round cake mould

Molde redondo

Ref	€	Ø (cm)	L	Pack
68751	11,10	24x5	1,50	1



### Molde cuadrado

Moule à carre

Quadratische Pfanne

Square cake mould

Molde cuadrado

Ref	€	cm	L	Pack
68752	11,40	23x23x5	2,00	1



### Molde rectangular

Moule à rectangulaire

Rechteckig Pfanne

rectangular mould

Molde rectangular

Ref	€	cm	L	Pack
68753	10,50	34x24x2	1,40	1



### Molde Muffin (6 Cav.)

Moule à Muffin

Muffinform

Muffinmould

Molde Muffin

Ref	€	Cav. (cm)	ml	Pack
68754	11,60	7x3	73 (cav.)	1



**Molde 12 cavidades madalenas**

Plaque madeleine 12 alveoles  
 Madeleine-Packform für 12 Madeleine  
 12 cups madelaine pan  
 Molde cavidades 12 madalenas

Ref	€	cm	Pack
68000	12,40	39,8x19,5x2	12



**Molde 12 cavidades**

Plaque à biscuits 12 alveoles  
 Madeleine-Backform für 12 Madeleine  
 12 cups muffin pan  
 Molde 12 cavidades

Ref	€	cm	Pack
68010	14,60	35x26,5x3	6



**Molde desmontable redondo chapa antiad.**

Moule rond desmontable  
 Tortenbodenform  
 Dismountable round mould  
 M. desmontável redondo chapa anti-aderente

Ref	€	Ø (cm)	Pack
68714	8,50	24x7	6
68716	9,00	26x7	6
68718	9,10	28x7	6



**Molde cake chapa antiaderente**

Moule à cake tôle anti-adh.  
 Back/Pastetenform, Antihaft  
 Cake mould rolled B S. non s.  
 molde cake chapa aderente

Ref	€	cm	h (cm)	Pack
68725	7,00	25x12	8,5	6
68730	7,30	30x12	8,5	6
68735	7,80	35x12	8,5	6



**Juego 4 cornetes chapa antiaderente**

Ensemble de 4 moule cornet antiadhesive  
 4 Tlg. nasenmuscheln, antihaft  
 4 pcs. non stick cream horn set  
 Jogo 4 forma de cornucópia anti-aderente

Ref	€	cm	Pack
68936	5,40	12	6



## Moldes bombón

**New**



**Molde profesional para elaborar deliciosos y originales bombones**

**Fabricado en Poliestireno de alta calidad**

**Se obtienen bombones perfectos y con un brillo único**

**Cómodo de utilizar: Rellena el molde con chocolate fundido, retira el exceso de chocolate, deja reposar, vuelca el molde y da un pequeño golpe para que salgan los bombones**

**Fácil de limpiar y resistentes al uso diario**

**Superficie lisa para un mejor desplazamiento de la espátula a la hora de retirar el chocolate sobrante**

**Disponibles en 10 modelos distintos**

Moule professionnel pour élaborer de délicieux et originaux chocolats

Fabriqué en polystyrène de grande qualité

Permet d'obtenir des chocolats parfaits avec une brillance unique

Facile à utiliser : Remplir le moule de chocolat fondu, retirer l'excès de chocolat, laisser reposer, retourner le moule et tapoter légèrement pour faire sortir les chocolats.

Facile à nettoyer et résistant à l'usage quotidien

Surface lisse pour un meilleur mouvement de la spatule lors du retrait du chocolat excédentaire

Disponibles en 10 modèles différents

Professionelle Gießform zum Herstellen Ihrer eigenen feinen Pralinen

Aus hochwertigem Polystyrol

Formt perfekte Pralinen mit besonders glänzender Oberfläche

Leichte Anwendung: Geschmolzene Schokolade in Gießform einfüllen, Schokoladenreste entfernen, ruhen lassen, Gießform umdrehen und Pralinen durch leichtes Klopfen herauslösen

Langlebig und leicht zu reinigen

Dank der glatten Oberfläche lassen sich Schokoladenreste leicht mit einem Spachtel entfernen

In 10 verschiedenen Formen erhältlich

Professional mould for making delicious and original chocolates

Made of high quality polystyrene

Makes perfect chocolates with a unique shine

Easy to use: Fill the mould with melted chocolate. Remove the excess chocolate. Let sit. Flip the mould over and tap gently to get the chocolates out.

Easy to clean and stands up to daily use

Smooth finish so a spatula will slide easily over the surface when removing extra chocolate

Available in 10 different models

Molde profissional para elaborar deliciosos e originais bombons

Fabricado em Poliestireno de alta qualidade

Permite obter bombons perfeitos e com um brilho único

Fácil de utilizar: encha o molde com chocolate fundido, retire o excesso de chocolate, deixe repousar, vire o molde e dê um pequeno golpe para que os bombons se soltem

Fácil de limpar e resistente ao uso diário

Superfície lisa para uma melhor deslocação da espátula ao retirar o chocolate sobrante

Disponível em 10 modelos distintos

### Dimensiones / Sizes

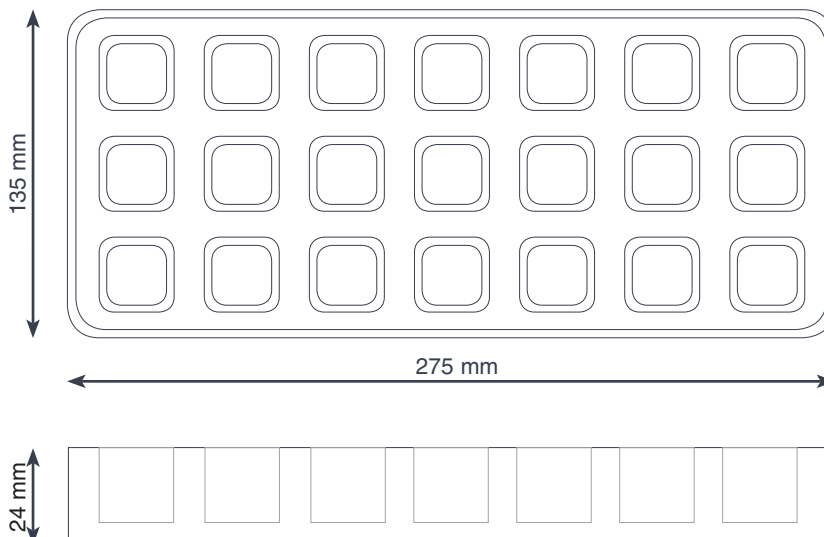

**New**



**Molde bombón Semiesférica**

Moule pour chocolats Hemisphere  
Halbkugelform Pralinengießform  
Half-sphere chocolate mould  
Molde para bombons Semi-esférica



Ref	€	Ø (mm)	h (mm)	Pack
66870	14,50	28	19	1



**Molde bombón Corazón**

Moule pour chocolats Coeur  
Herzform Pralinengießform  
Heart chocolate mould  
Molde para bombons Coração



Ref	€	mm	h (mm)	Pack
66871	14,50	25x20	11,5	1



**Molde bombón Lineal**

Moule pour chocolats Lineaire  
Linearform Pralinengießform  
Linear chocolate mould  
Molde para bombons Linear



Ref	€	mm	h (mm)	Pack
66872	14,50	25,5x24,5	17	1



**Molde bombón Oval**

Moule pour chocolats Ovale  
Ovalform Pralinengießform  
Oval chocolate mould  
Molde para bombons Oval



Ref	€	mm	h (mm)	Pack
66873	14,50	30x18	19	1



**Molde bombón Cuadrado**

Moule pour chocolats Carrée  
Pralinengießform, viereckig  
Square chocolate mould  
Molde para bombons quadrado



Ref	€	mm	h (mm)	Pack
66874	14,50	25x25	17	1



**Molde bombón Hoja**

Moule pour chocolats Feuillere  
Blatt Pralinengießform  
Leaf chocolate mould  
Molde para bombons folha



Ref	€	mm	h (mm)	Pack
66875	14,50	32x19	12	1

**New**



**Molde bombón rectangular**  
Moule pour chocolats Rectangulaire  
Pralinengießform, rechteckig  
Rectangular chocolate mould  
Molde para bombons Rectangular



Ref	€	mm	h (mm)	Pack
66876	14,50	25x15,5	12	1



**Molde bombón Ondulado**  
Moule pour chocolats Ondulé  
Onduliert Pralinengießform  
Ondulated chocolate mould  
Molde para bombons Ondulado



Ref	€	mm	h (mm)	Pack
66877	14,50	32x25	12,5	1



**Molde bombón Prisma**  
Moule pour chocolats Prismee  
Prisma Pralinengießform  
Prism chocolate mould  
Molde para bombons Prisma

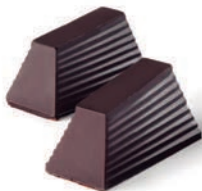

Ref	€	mm	h (mm)	Pack
66878	14,50	36x16	17	1



**Molde bombón Cónica**  
Moule pour chocolats Conique  
Pralinengießform, Konisch  
Conical chocolate mould  
Molde para bombons Conica



Ref	€	Ø (mm)	h (mm)	Pack
66879	14,50	25,5	19	1



## Aros Perforados



**Innovadores aros de acero inoxidable microperforados.**

**Disponible en distintas formas y tamaños**

**Ideal para masa brisa, hojaldre y choux**

**Las microperforaciones permiten la circulación de aire durante la cocción, consiguiendo una cocción más rápida y homogénea**

Cercle en acier inoxydable micro-perforé innovant. Disponible en plusieurs formes et tailles.

Idéal pour la pâte brisée, la pâte feuilletée et la pâte à choux

Les micro-perforations permettent la circulation d'air pendant la cuisson, obtenant ainsi une cuisson plus rapide et homogène

Innovativer mikroperforierter Edelstahlring. In verschiedenen Formen und Größen verfügbar.

Ideal für Mürbeteig, Blätterteig und Brandmasse

Die Mikroperforierungen erlauben die Luftzirkulation während des Backens und erzielen eine schnellere und gleichmäßigere Garung

Innovative microperforated stainless steel tart ring. Available in various different shapes and sizes. Ideal for shortcrust, puff and choux pastry

The microperforations enable air to circulate during cooking, ensuring faster and more even cooking

Inovador aro de aço inoxidável microperfurado. Disponível em diferentes formas e tamanhos. Ideal para massa quebrada, folhados e choux

As microperforações permitem a circulação do ar durante a cocção, tornando-a mais rápida e homogénea

### Aro redondo perforado

Cercle rond perforé

Kuchen-/Ausstechformen, rund, gelocht

Perforated round cake ring

Aro redondo perforada



Ref	€	Ø (cm)	h (cm)	Pack
68537	2,40	7	2,0	6
68536	4,00	16	2,0	6
68538	4,40	18	2,0	6
68540	4,90	20	2,0	6
68544	5,80	24	2,0	6
68547	3,30	7	3,5	6
68546	6,10	16	3,5	6
68548	6,90	18	3,5	6
68550	7,50	20	3,5	6
68554	8,90	24	3,5	6

### Aro cuadrado perforado

Cercle carre perforé

Kuchen-/Ausstechformen, viereckig, gelocht

Perforated square cake ring

Aro cuadrado perforada

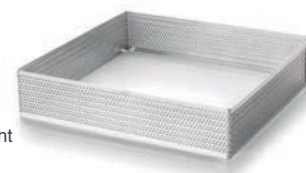

Ref	€	cm	h (cm)	Pack
68557	2,80	7x7	2,0	6
68556	4,80	16x16	2,0	6
68560	6,00	20x20	2,0	6
68567	3,90	7x7	3,5	6
68566	7,50	16x16	3,5	6
68570	9,10	20x20	3,5	6

### Aro rectangular perforado

Cercle rectangulaire perforé

Kuchen-/Ausstechformen, rechteckig, gelocht

Perforated rectangular cake ring

Aro rectangular perforada

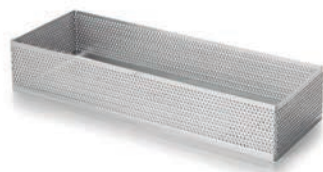

Ref	€	cm	h (cm)	Pack
68590	4,10	7x20	2,0	6
68598	5,10	8x28	2,0	6
68591	6,30	7x20	3,5	6
68597	8,10	8x28	3,5	6

### Aro oval perforado

Cercle oval perforé

Kuchen-/Ausstechformen, oval, gelocht

Perforated oval cake ring

Aro oval perforada

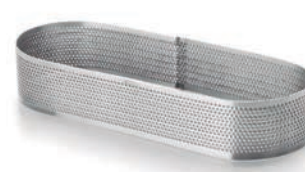

Ref	€	cm	h (cm)	Pack
68580	3,90	7x20	2,0	6
68588	5,00	8x28	2,0	6
68581	5,80	7x20	3,5	6
68587	7,70	8x28	3,5	6



## Aros

### Aro redondo

Cercle rond  
Kuchen-/Ausstechformen, rund  
Round cake ring  
Aro redondo



Ref	€	Ø (cm)	h (cm)	Pack
68406	2,40	6	4	6
68407	2,50	7,5	4	6
68408	2,60	8	4	6
68410	2,70	10	4	6
68412	4,30	12	4	6
68414	4,00	14	4	6
68416	5,50	16	4	6
68418	6,60	18	4	6
68420	7,90	20	4	6
68422	8,00	22	4	6
68424	9,10	24	4	6

### Aro redondo Entremet

Cercle rond Entremet  
Kuchen-/Ausstechformen, rund, Entremet  
Round cake ring Entremet  
Aro redondo Entremet



Ref	€	Ø (cm)	h (cm)	Pack
68308	2,50	8	3,5	6
68310	2,50	10	3,5	6

### Aro redondo Mouse

Cercle rond Mousse  
Kuchen-/Ausstechformen, rund, Mousse  
Round cake ring Mouse  
Aro redondo Mouse



Ref	€	Ø (cm)	h (cm)	Pack
68506	2,40	6	4,5	6
68508	2,50	8	4,5	6
68509	2,60	9	4,5	6
68510	2,70	10	4,5	6
68512	3,40	12	4,5	6
68514	4,00	14	4,5	6
68516	5,60	16	4,5	6
68518	6,50	18	4,5	6
68520	7,10	20	4,5	6
68522	8,20	22	4,5	6
68524	8,50	24	4,5	6
68526	9,40	26	4,5	6

### Aro tarta borde vuelto

Cercle "goutte"  
Tortenring  
Tart ring  
Anel tarta

Ref	€	Ø (cm)	Pack
68107	2,80	8x2,2	6
68121	3,00	10x2,2	6
68120	6,10	20x2,2	6



Inox 18/10

### Aro redondo Vacherin

Cercle rond Vacherin  
Kuchen-/Ausstechformen, rund, Vacherin  
Round cake ring Vacherin  
Aro redondo Vacherin



Ref	€	Ø (cm)	h (cm)	Pack
68607	3,40	7	6	6
68608	3,50	8	6	6
68609	3,60	9	6	6
68610	3,70	10	6	6
68612	5,00	12	6	6
68614	5,90	14	6	6
68616	7,90	16	6	6
68618	8,90	18	6	6
68620	11,70	20	6	6
68622	12,50	22	6	6
68624	13,50	24	6	6
68626	14,40	26	6	6
68628	15,60	28	6	6

### Aro repostería extensible

Cercle extensible  
Kuchenausstechformen, aussziehbar  
Adjustable pastry ring  
Aro extensible pastelería

Ref	€	Ø (cm)	h (cm)
68200	14,70	16-30	7,0

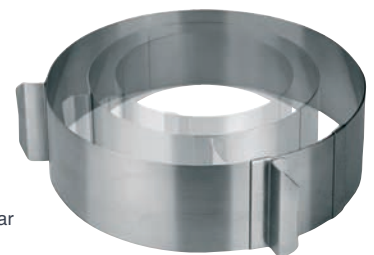

### Juego aros repostería ( 4 pcs)

Ensemble de cercles à pâtisserie  
Ausstechformen, Set  
Pastry rings set  
Jogo aros de pastelería

Ref	€	Forma	cm	Pack
68203	8,90	Redondo/Round	Ø7,7x5	12
		Redondo/Round	Ø10,7x5	
		Cuadrado/Square	8,2x8,2x5	
		Triángulo/Triangle	6x5	



Inox 18/10

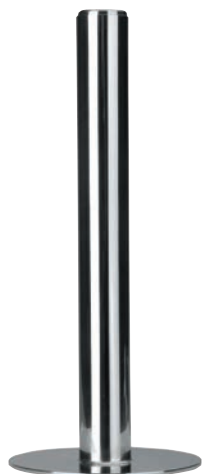

**Diseñado para su uso en cocina y repostería como complemento de los marcos o aros**  
**Excelente resistencia a la corrosión y a los ácidos alimentarios y sales**

Conçu pour une utilisation en cuisine et pâtisserie en tant que complément des emporte-pièces  
Excellente résistance à la corrosion et aux sels et acides alimentaires

Als Zubehör für runde und eckige Backformen in Küchen und Konditorei  
Sehr korrosionsbeständig und widerstandsfähig gegen Säure aus Lebensmitteln und Salzen

Designed for use in cooking and baking as an accessory to frames or rings  
Excellent resistance to corrosion and to food acids and salts

Concebido para utilização na cozinha e em pastelaria, como complemento dos marcos ou aros  
Excelente resistência à corrosão e aos ácidos e sais alimentares

**Empujador aro repostería**

Poussoir Inox pour cercles à pâtisserie  
Andrücker für Kuchenforms  
St. Steel pusher for pastry ring  
Empurrador para aro de pastelaria

Ref	€	cm	Pack
68890	8,70	7x16,2	6

**Molde cuadrado**

Carre pour pâtisserie  
Kuchen-/Ausstech formen, vierecking  
Square pastry mould  
Molde quadrado

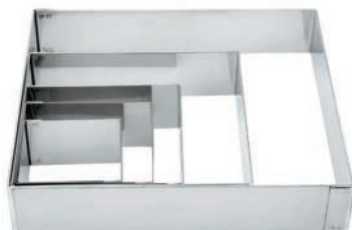

Ref	€	cm	Pack
68460	3,80	6x6x4	6
68480	3,90	8x8x4	6
68411	4,00	10x10x4	6
68441	4,30	14x14x4	6
68240	5,00	20x20x4	6

Lacor

°C / °F

+

-

▶

TEMP

+

-

■

TIME







ELÉCTRICO  
•  
ELECTRIC

Eléctrico  
*Electric*  
•  
Calentadores  
*Lamps*



# CookingMe

· Household use ·



**Diseñado para hacerte el día a día más fácil en tu cocina**  
**Realiza todas tus recetas de manera rápida y sin esfuerzo**  
**Múltiples funciones: cocer, sofreír, picar, triturar, cocer al vapor, mezclar, batir, amasar, emulsionar y pesar, solo tienes que darle la orden**  
**Panel de control de fácil manejo**  
**Incluye accesorios para elaborar todo tipo de recetas**

Conçu pour vous faciliter la tâche dans votre cuisine quotidienne  
 Il réalise toutes les recettes de manière rapide et sans effort  
 Multiples fonctions : cuire, saisir, hacher, broyer, cuire à la vapeur, mélanger, mixer, pétrir, émulsionner et peser, vous n'avez qu'à lui donner l'ordre  
 Tableau de commande facile à manœuvrer  
 Il inclut les accessoires pour élaborer tout type de recettes

Macht das Leben in der Küche leichter  
 Alle Rezepte lassen sich schnell und einfach zubereiten  
 Multitalent mit vielen Funktionen: kochen, anbraten, zerkleinern, mahlen, dampfgaren, vermischen, mixen, kneten, emulgieren und wiegen auf Knopfdruck möglich  
 Übersichtliches Bedienfeld  
 Mit komplettem Zubehör

Designed to make everyday life easier in your kitchen  
 Makes all your recipes quickly and effortlessly  
 Multiple functions: cook, sauté, chop, shred, steam, mix, beat, knead, emulsify and weigh, you just have to give the order  
 Easy-to-use control panel  
 Includes accessories to make all kinds of recipes

Concebido para tornar mais fáceis as tarefas da cozinha  
 Elabora todas as tuas receitas de maneira rápida e sem esforço  
 Várias funções: cozer, refogar, picar, triturar, cozer a vapor, misturar, bater, amassar, emulsionar e pesar  
 Painel de controlo fácil de utilizar  
 Inclui acessórios para elaborar todo o tipo de receitas

## Todo en uno

All-in-one



*· Incluye Recetario ·*  
 Inklus livre de recettes · Recipe Book included



### CookingMe

Ref	€	Pack	
69561E	725,00	1	CookingMe + Recetario en ESPAÑOL · CookingMe + Recipe book in SPANISH
69561F	725,00	1	CookingMe + Recetario en FRANCÉS · CookingMe + Recipe book in FRENCH
69561I	725,00	1	CookingMe + Recetario en INGLES · CookingMe + Recipe book in ENGLISH

Ref	Tensión Voltage	Potencia/Power	Velocidad Speed	Temp./Temp.	Capacidad capacity	Funciones/Memorias Functions/Memories	Báscula Scale	Dimensiones Sizes	Peso/Weight
69561E 69561F 69561I	220-240 V/50-60 Hz	Motor:1000 W Calent/Heating:1000 W	60 - 10.000 r.p.m	37°C - 120°C	2,0 L	15 / 3	5 Kg (div.: 1 g)	39x30x33 cm	7,80 Kg



**Pan y masas**  
Bread and pasta



**Salsas**  
Sauces



**Sopas**  
Soups



**Verduras**  
Vegetables



**Pescados**  
Fish

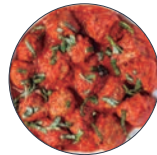

**Carnes**  
Meatss



**Bebidas**  
Drinks



**Postres**  
Desserts

## Accesorios

Accessoires · Zubehör · Accessories · Acessórios

### Recetario

Cookbook  
Kochbuch  
Cookbook  
Livro de receitas



Ref	€	Pack	
R69561N	26,50	1	Español
R69561P	26,50	1	Francés
r69561Q	26,50	1	Ingles

### Jarra

Pitcher  
Kanne  
Picher  
Jarra



Ref	€	L	Pack
R69561A	154,00	2,0	1

### Tapa para jarra

Couvercle pour pitcher  
Deckel für Kanne  
Lid for picher  
Tampa para jarra



Ref	€	Pack
R69561E	12,50	1

### Vaso dosificador

Verre doseur  
Dosierbecher  
Measuring glass  
Copo dosificador

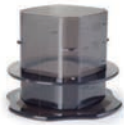

Ref	€	ml	Pack
R69561W	2,10	100	1

### Cestillo colador

Panier passoire vapeur  
Dampfsieb  
Steam strainer basket  
Cesto coador



Ref	€	Pack
R69561C	15,00	1

### Anilla fijación / bloqueo

Anneau de fixation / verrouillage  
Dichtungsring / Arretierung  
Fixing ring  
Anilla de fixação / bloqueio



Ref	€	Pack
R69561Z	2,10	1

### Cuchillas

Couteaux  
Klinge  
Blades  
Lâminas



Ref	€	Pack
R69561B	30,00	1

### Amasador

Accessoire à pétrir  
Kneteinsatz  
Kneader  
Acessório para amassar



Ref	€	Pack
R69561V	24,80	1

### Emulsionador

Fouet  
Rührhaufsatz (Schmetterlig)  
Emulsifier  
Batedor de borboleta



Ref	€	Pack
R69561T	4,10	1

### NO apta para el lavavajillas

NOT dishwasher safe

### Espátula

Spatule  
Kelle  
Spatula  
Espátula



Ref	€	Pack
R69561S	6,20	1

### Báscula

Balance  
Waage  
Scale  
Balança



Ref	€	Kg	Pack
R69561F	27,00	5,0	1

### Vaporera (No incluida)

Ensemble vapeur (Non fourni)  
Dampfeinsatz (Nicht inbegriffen)  
Steam (Not included)  
Conjunto de vapor (Não incluído)



Ref	€	Pack
R69561D	72,00	1

### Accesorios aptos para la limpieza en el lavavajillas

Accessoires adaptés au nettoyage au lave-vaisselle · Zubehör angepasst für in der Spülmaschine reinigen · Accessories suitable for cleaning in the dishwasher  
Acessórios adaptado para a limpeza na máquina de lavar

# Olla Programable

· Household use ·

*Incluye recetario para sus 20 funciones*  
*Inclut un livre de recettes pour 20 fonctions*  
*Includes recipe book for 20 functions*



**Olla eléctrica programable**  
 Cocotte électrique programmable  
 Programmierbarer Elektrokochtopf  
 Programmable electric cooker  
 Panela eléctrica programável

Ref	€	Pack
69335	186,30	1

**Herméticamente sellada para obtener una mejora del sabor sin perder nutrientes**  
**Pantalla LCD, táctil y en dos idiomas (Castellano e ingles)**  
**Multifunción: 20 Funciones**  
**Incluye: Yogurtera, cestillo freidora, vaso medidor, cuchara, espátula, pinza y bandeja cocción al vapor**

Fermeture hermétique pour obtenir une meilleure saveur sans perdre les nutriments  
 Écran LCD, tactile et en deux langues (Espagnol et anglais)  
 Multifonction: 20 fonctions  
 Comprend: Pot à yaourt, panier friteuse, verre doseur, cuillère, spatule, pince et plateau cuisson vapeur

Hermetisch abgedichtet für einen besseren Geschmack ohne Nährstoffverluste  
 LCD-Touch-Screen zweisprachig (Spanisch und Englisch)  
 Multifunktion: 20 Funktionen  
 Umfasst Joghurt, Frittierkorb, Messbecher, Löffel, Backschaufel, Zange und Dampfgarblech

Hermetically sealed to give an improved flavour without losing nutrients  
 LCD touch screen in two languages (Spanish and English)  
 Multifunction: 20 function  
 Includes: Yoghurt, fryer basket, measuring cup, spoon, spatula, tong and steaming pan

Hermeticamente seladas, para conservar o sabor sem perder os nutrientes  
 Ecrã LCD, tátil e em dois idiomas (espanhol e inglês)  
 Multifunção: 20 funções  
 Inclui: logurte, cesto para fritar, copo medidor, colher, espátula, pinça e bandeja para cocção ao vapor

Multicocción/Multicool	Sopa/Soup	Cocinar/Cook	Guisar/Stew	Hornear/Bake
Cocinado rápido/Fast cook	Arroz/Rice	Vapor/Steam	Judias/Grain	Mermelada/Jam
Auto-limpieza/Autoclean	Yogur	Bizcocho/Cake	Pan/Bread	Saltear/Fry
Cocción lenta/Slow cook	Pilaf	Potaje/Milk congee	Gelatina/Jelly	Freír/Deep fry

Ref	Tensión/Voltage	Potencia/Power	Temperatura/Temp.	Capacidad/Capacity	Dimensiones/Sizes	Peso/Weight
69335	220-230 V / 50-60 Hz	950 W	35°C -180°C	5,0 L	30x26,5x26 cm	6,50 Kg

## Haz todo lo que te propongas

Faites tout ce dont vous avez envie · Für alle Kochideen · Do everything you want to do · Elabora todos os pratos que queiras



**Potajes**  
 Ragoût · Suppes  
 Potages · Potajes



**Carnes**  
 Viandes · Fleisch  
 Meats · Carnes



**Pescados**  
 Poisson · Fisch  
 Fish · Peixe



**Postres**  
 Desserts · Desserts  
 Desserts · Sobremesas



**Yogur**  
 Yaourt · Joghurt  
 Yoghurt · logurte



**Mermeladas**  
 Confitures · Marmelades  
 Jam · Geléias

## Accesorios

Accessoires · Zubehör · Accessories · Acessórios



**Yogurt, cestillo freidora, vaso medidor, cuchara, espátula, pinza y bandeja cocción al vapor**

Pot à yaourt, panier friteuse, verre doseur, cuillère, spatule, pince et plateau cuisson vapeur

Joghurt, Frittierkorb, Messbecher, Löffel, Backschaufel, Zange und Dampfgarblech

Yoghurt, fryer basket, measuring cup, spoon, spatula, tong and steaming pan

logurte, cesto para fritar, copo medidor, colher, espátula, pinça e bandeja para cocção ao vapor



## Panificadora

· Household use ·

Inox  
18/10

AC



**Especial para panes de 900 g y programa de elaboración de mermelada casera**

**Cavidad especial para frutos secos y semillas**  
**Cubetas antiadherentes; Rectangular y redonda**

Spécial pour pains de 900 g et programme d'élaboration de confiture maison  
Cavité spéciale pour fruits secs et graines. Cuves antiadhésives; Rectangulaire et ronde

Besonders für Brot mit 900 g Gewicht geeignet und mit Programm zur Herstellung von hausgemachter Marmelade  
Besondere Vertiefung für Trockenfrüchte und Samen. Antihafbeschichtete Behälter; rechteckig und rund

Especially for 900 g breads and home-made jam preparation programme  
Special hole for nuts and seeds. Anti-stick trays: Rectangular and round

Especial para pães de 900 g e programa de elaboração de marmelada caseira  
Cavidade especial para frutos secos e sementes. Cuvetes antiaderentes; retangular e redonda

**Panificadora**

Machine à pain  
Brotbackmaschine  
Bread-making machine  
Máquina de fazer pão

Ref	€	Pack
69316	180,50	1

Ref	Tensión/Voltage	Potencia/Power	Opciones/Options	Capacidad/Capacity	Dimensiones/Sizes	Peso/Weight
69316	220-240 V / 50-60 Hz	710 W	13	2,70 L(900 g)	38x30x34 cm	670 g

## Máquinas Helado

· Household use ·

Inox  
18/10

DC



*Recetas en el interior*  
*Recettes à l'intérieur · Recipes inside*



**Helados 100% naturales**  
**Disfruta de helados saludables y bajos en calorías**  
**100% natural ice creams**  
**Enjoy healthy, low-calorie ice creams**

**Una nueva forma de hacer helado cremoso y saludable**  
**Puedes realizar innidad de helados de; fresa, plátano, kiwi, mango, piña, melón, etc...**  
**Ideal para dietas especiales: sin leche, sin azúcar, sin gluten**  
**Fácil de usar y muy rápida. Diseño elegante**

Une nouvelle façon de faire des glaces crémeuses et saines  
Vous pouvez réaliser une infinité de glaces : à la fraise, à la banane, au kiwi, à la mangue, à l'ananas, à l'orange, au melon, etc.  
Idéale pour les régimes alimentaires spéciaux : sans lait, sans sucre, sans gluten.  
Facile à utiliser et très rapide. Style élégant

Eine neue Art, cremiges und gesundes Eis  
Sie können unzählige Eissorten herstellen: Erdbeere, Banane, Kiwi, Mango, Ananas, Orange, Melone usw.  
Ideal für besondere Ernährungsweisen: ohne Milch, ohne Zucker, glutenfrei  
Leicht zu bedienen und sehr schnell. Elegantes Design

A new way to make creamy and healthy ice cream  
You can make a wide variety of ice creams; strawberry, banana, kiwi, mango, pineapple, orange, melon, etc...  
Ideal for special diets: milk-free, sugar-free, gluten-free  
Easy to use and very fast. Stylish design

Uma nova maneira de elaborar um gelado cremoso e saudável  
Podes preparar uma grande variedade de gelados de morango, banana, kiwi, mango, ananás, laranja, melão, etc.  
Ideal para dietas especiais: sem leite, sem açúcar, sem glúten  
Rápido e fácil de usar. Design elegante

**Máquina elaboración helado**

Machine de fabrication de crème glacée  
Eis Maschine  
Ice cream making machine  
Máquina para fazer gelado

Ref	€	Pack
69315	377,00	1

Ref	Tensión/Voltage	Potencia/Power	Temperatura/Temp.	Capacidad/Capacity	Tiempo/Timer	Dimensiones/Sizes	Peso/Weight
69315	220-240 V / 50 Hz	150 W	-18°C / -35°C	1,40 L	60 min.	38x29x31 cm	12,20 Kg



# Yogurteras

· Household use ·



*Recetas en el interior*  
Recettes à l'intérieur · Recipes inside

**Elabora deliciosos yogures caseros del sabor y textura que te apetezca**  
**Es muy sencillo de utilizar**  
**Tiempo de preparación de 8 -14 h**  
**Disfruta de yogures naturales y saludables generando menos residuos**  
**Fácil de limpiar**

Élaborez de délicieux yaourts maison avec le goût et la texture que vous préférez  
Cet appareil est très facile à utiliser.  
Durée de préparation : 8 - 14 h  
Savourez des yaourts naturels et sains tout en générant moins de déchets  
Appareil facile à nettoyer

Zum Herstellen leckerer Joghurts mit Zutaten und Konsistenz nach Ihrem Geschmack  
Einfache Bedienung mit nur einem Knopf  
Dauer 8 -14 Std.  
Genießen Sie natürliche und gesunde Joghurts ohne viel Abfall zu produzieren  
Einfach zu reinigen

Make delicious home-made yoghurt with the flavour and texture you want  
Because it only has one button, it's easy to use  
Preparation time 8 - 14 h  
Enjoy healthier and more natural yoghurt while generating less waste  
Easy to clean

Elabore deliciosos iogurtes caseiros, com o seu sabor e textura preferidos  
Fácil de utilizar  
Tempo de preparação máximo de 8 - 14 h  
Desfruta de iogurtes naturais e saudáveis, gerando menos resíduos  
Fácil de limpar



## Disfruta de yogures más sanos y naturales

Savourez des yaourts sains et naturels · Genießen Sie ganz natürliche und gesunde Joghurts · Enjoy healthier and more natural yoghurt  
Desfrute de iogurtes mais saudáveis e naturais



**Con filtro para elaboración de yogur griego**  
With filter for how to make greek yoghurt

**Yogurtera de vasos MULTI**  
Yaourtière à pots  
Joghurt-Maker mit Glasbehältern  
Yoghurt maker with jars  
Iogurteira de frascos

**Yogurtera WHITE**  
Yaourtière  
Joghurt-Maker  
Yoghurt maker  
Iogurteira

Ref	€	Pack
69245	36,10	1

Ref	€	Pack
69246	31,40	1



Ref	Tensión/Voltage	Potencia/Power	Temporizador/Timer	Capacidad/Capacity	Dimensiones/Sizes	Peso/Weight
69245	220-240 V / 50-60 Hz	20 W	1 -14 h	190 ml	Ø25x12 cm	1,80 Kg
69246	220-240 V / 50-60 Hz	20 W	-	1,0 L (Filtro · Filter) 1,6 L (Pequeño · Small) 1,8 L (Grande · Big)	18x16x24 cm	0,85 Kg

## Batidoras · Amasadoras

· Professional use ·



### Batidor eléctrico con bol PROFESIONAL

Fouet électrique avec bol "Profesional"  
Elektrisches Rühr-Mixgerät, "Profesional"  
"Profesional" Electric blender with bowl  
Batedeira eléctrica com bacia "Profissional"

Ref	€	Pack
69084	699,10	1

Ref	Tensión/Voltage	Potencia/Power	Velocidad/Speed	Capacidad/Capacity	Dimensiones/Sizes	Peso/Weight
69084	220-240 V / 50-60 Hz	300 W	130 - 850 r.p.m	5,0 L	23x14,5x41 cm	20,8 Kg



**Batir, mezclar, amasar productos para la preparación de alimentos**  
**Velocidad regulable, doble movimiento de giro, rotativo y orbital**

Batte, mélanger, pétrir des produits pour la préparation d'aliments  
Vitesse réglable, double mouvement de rotation, rotatif et orbital

Schlagen, Mischen, Kneten von Produkten zur Zubereitung von Nahrungsmitteln  
Regelbare Geschwindigkeit, doppelte Drehbewegung, rotatorisch und orbital

Beat, mix and knead products to food preparation  
Adjustable speed, double twisting, rotating and orbital motion

Bater, misturar, amassar produtos para a preparação de alimentos  
Velocidade regulável, duplo movimento rotativo e orbital

· Semiprofessional use ·



**Batir, mezclar, amasar productos para la preparación de alimentos**  
**Cuatro funciones preestablecidas**  
**Velocidad regulable, doble movimiento de giro, rotativo y orbital**

Batte, mélanger, pétrir des produits pour la préparation d'aliments  
Quatre fonctions préétablies  
Vitesse réglable, double mouvement de rotation, rotatif et orbital

Schlagen, Mischen, Kneten von Produkten zur Zubereitung von Nahrungsmitteln  
Vier vorprogrammierte Funktionen  
Regelbare Geschwindigkeit, doppelte Drehbewegung, rotatorisch und orbital

Beat, mix and knead products to food preparation  
Four pre-set functions  
Adjustable speed, double twisting, rotating and orbital motion

Bater, misturar, amassar produtos para a preparação de alimentos  
Quatro funções programadas  
Velocidade regulável, duplo movimento rotativo e orbital

### Batidora amasadora con bol

Batteur pétrisseur avec bol  
Mix- und kneatmaschine mit Schüssel  
Mixer-kneader with bowl  
Batedeira amassadora com taça

Ref	€	Pack
69183	316,10	1

Ref	Tensión/Voltage	Potencia/Power	Velocidad/Speed	Capacidad/Capacity	Dimensiones/Sizes	Peso/Weight
69183	220-240 V / 50-60 Hz	1200 W	15.000 r.p.m.	6,0 L	42x26x51 cm	9,50 Kg

• Household use •

*Rapidez y eficacia  
quickly and effectively*



**Amasado con movimientos planetarios**  
**Doble movimiento de giro, rotatorio y orbital**  
**1,2 Kg de capacidad para el amasado**  
**Brazo basculante de 35° para acoplar los distintos accesorios**

Pétrissage avec des mouvements planétaires  
 Double mouvement de rotation, rotatoire et orbital  
 Capacité de 1,2 kg pour le pétrissage  
 Bras pivotant de 35° pour fixer aisément les différents accessoires

Planeten-Rührsystem  
 Doppelte Dreh-, Rotations- und Planetarbewegung.  
 1,2 kg Teig-Fassungsvermögen  
 Im 35° Winkel schwenkbarer Arm, um die verschiedenen Accessoires einzustecken

Mixer with planetary motion  
 Twin twisting, rotational and orbital movement  
 1,2 kg mixer capacity  
 35° swing arm for connection of different accessories

Movimento de amassar planetário  
 Duplo movimento de rotação e orbital  
 Capacidade de 1,2 Kg de massa  
 Braço basculante de 35° para acoplar os diferentes acessórios

**Batidora amasadora con bol GOURMET**

Batteur pétrisseur avec bol  
 Mix- und knetmaschine mit Schüssel  
 Mixer-kneader with bowl  
 Batedeira amassadora com taça

Ref	€	Pack
69388	175,20	1

Ref	Tensión/Voltage	Potencia/Power	Velocidad/Speed	Velocidad/Speed	Capacidad/Cap.	Dimensiones/Sizes	Peso/Weight
69388	220-240 V / 50-60 Hz	600 W	6	10.000 r.p.m.	4,0 L	35x22x30 cm	4,40 Kg

• Household use •



**Incluye dos juegos de varillas para batir y amasar**  
**5 potencias y Turbo**

Inclut deux sets de fouets pour battre et pétrir  
 5 puissances et Turbo

Enthält zwei Einsätze zum Schlagen und Kneten  
 5 Leistungsstufen und Turbo

Includes two sets of bars to beat and knead  
 5 power settings and Turbo

Inclui dois jogos de varetas para bater e amassar  
 5 níveis de potência e Turbo

**Batidora-Mezcladora eléctrica**

Fouet-mélangeur électrique  
 Einfaches Standmixgerät  
 Electric blender-mixer  
 Batedeira-misturadora eléctrica

Ref	€	Pack
69083	95,10	1

Ref	Tensión/Voltage	Potencia/Power	Velocidad/Speed	Capacidad/Capacity	Dimensiones/Sizes	Peso/Weight
69083	220-240 V / 50-60 Hz	250 W	1.200 r.p.m.	2,80 L	23x31x25 cm	2,92 Kg

· Professional use ·



**Batidora eléctrica simple en columna**

Batteur électrique simple en colonne  
Einfaches elektrisches Standmixgerät  
Upright single electric blender  
Batedeira eléctrica simples com coluna

Ref	€	Pack
69085	317,10	1



**Batidora eléctrica**

Batteur électrique  
Elektrisches mixer  
Electric blender  
Batedeira eléctrica

Ref	€	Pack
69111	231,80	1

Ref	Tensión/Voltage	Potencia/Power	Velocidad/Speed	Capacidad/Capacity	Dimensiones/Sizes	Peso/Weight
69085	220-240 V / 50-60 Hz	150 W	17.000 - 18.000 r.p.m.	0,70 L	19x16x53 cm	6,50 Kg
69111	220-240 V / 50-60 Hz	400 W	10.000 - 15.000 r.p.m.	0,60 L	21x15x51 cm	6,20 Kg



# Batidora varillas

· Household use ·



**Silenciosas, ligeras y extremadamente potentes, para una mayor comodidad durante el uso**  
**Mejores resultados en menos tiempo gracias a su motor de gran potencia**  
**5 niveles de velocidad + función turbo. Empuñadura ergonómica con SoftTouch**

Silencieux, léger et extrêmement puissant, pour une utilisation plus confortable  
 Meilleurs résultats en moins de temps grâce à son moteur de grande puissance  
 5 niveaux de vitesse + fonction turbo. Poignée ergonomique avec SoftTouch

Leise, leicht und extrem leistungsstark für eine bequeme Benutzung  
 Optimale Ergebnisse in kürzerer Zeit, dank seines leistungsstarken Motors  
 5 Geschwindigkeiten + Turbofunktion. Ergonomischer Griff mit SoftTouch

Silent, lightweight and extremely powerful for greater comfort during use  
 Better results in less time thanks to its powerful motor  
 5 speeds + turbo function. SoftTouch ergonomic handle

Silenciosa, leve e extremamente potente, para um maior conforto durante a utilização  
 Melhores resultados em menos tempo graças ao seu motor de grande potência  
 5 níveis de velocidade + função turbo. Cabo ergonómico com SoftTouch



### Varillas batidoras

Fouets pour battre  
 Rührbesen  
 Beater rods  
 Varas para bater



### Batidor de varillas eléctrico

Batteur à main électrique  
 Elektro-Handmixer  
 Electric hand mixer  
 Batedor eléctrico de mão

Ref	€	Pack
69383	49,70	1



### Batidor de varillas HOME

Batteur à main  
 Handmixer  
 Hand mixer  
 Batedor de mão

Ref	€	Pack
69384	37,00	1



### Varillas amasadoras

Fouets pour pétrir  
 Knethaken  
 Dough rods  
 Varas para amassar

Ref	Tensión/Voltage	Potencia/Power	Velocidad/Speed	Capacidad/Capacity	Dimensiones/Sizes	Peso/Weight
69383	220-240 V / 50-60 Hz	350 W	5 + TURBO	1000 g	20x10x18 cm	1,30 Kg
69384	220-240 V / 50-60 Hz	300 W	5 + TURBO	1000 g	18x8x14 cm	1,20 Kg

## Batidoras BRISK

**New**

· Professional use ·



*Rápido, eficiente y robusto*  
*Rapide, efficace et robuste*  
*Fast, efficient and robust*



**Batidora profesional con brazos trituradores y brazos batidores intercambiables**  
**Fabricado en materiales altamente resistentes y de máxima calidad**  
**El mango ergonómico ofrece mayor seguridad y control de la batidora**  
**Indicado para trabajar en ollas de hasta 140 litros de capacidad**  
**El bloque motor es adaptable a todos los brazos y batidores**  
**Los brazos trituradores, batidores y cuchillas, fabricados en acero inoxidable**  
**Colocación y desmontaje de los brazos sencillo e instantáneo, sin necesidad de utilizar herramientas**

**Prepara purés, cremas y todo tipo de salsas**

Mixeur professionnel avec accessoires interchangeables pour hacher et mixer  
 Fabriqué avec des matériaux hautement résistants et d'une qualité maximale  
 Le manche ergonomique offre une sécurité et un contrôle accru du mixeur  
 Indiqué pour travailler dans des marmites de jusqu'à 140 litres de contenance  
 Le bloc moteur s'adapte sur tous les accessoires  
 Accessoires pour hacher, mixer, couper, fabriqués en acier inoxydable  
 Installation et démontage des accessoires simple et instantané, sans utilisation d'outils supplémentaires  
 Permet de préparer des purées, des crèmes et tout type de sauces

Stabmixer mit austauschbaren Aufsätzen zum Zerkleinern und Pürieren  
 Aus strapazierfähigen und hochwertigen Materialien hergestellt  
 Ergonomischer Griff für sicheren Halt und Handhabung des Mixers  
 Eignet sich zur Arbeit mit bis zu 140 Liter großen Töpfen  
 Getriebeteil an alle Aufsätze und Mixstäbe anpassbar  
 Zerkleinerer, Pürierstab und Schneiden aus Edelstahl  
 Aufsätze lassen sich einfach und schnell ohne Einsatz von Werkzeugen einsetzen und entfernen  
 Zur Bereitung von Pürees, Cremes und alle möglichen Saucen

Professional blender with interchangeable beaters and shredders  
 Made from highly resistant materials of the highest quality  
 The ergonomic handle provides greater safety and control of the blender  
 Suitable for working in pots up to 140 litres  
 The motor block is adaptable to all arms and beaters  
 The shredders, beaters and blades are made of stainless steel  
 Fitting and removing the arms is simple and instant, without using tools  
 Prepare soups, purées and all kinds of sauces

Batedora profissional com braços trituradores e braços batedores intercambiáveis  
 Fabricada com materiais altamente resistentes e da máxima qualidade  
 O mango ergonómico oferece maior segurança e controlo da batedeira  
 Indicado para panelas de até 140 litros de capacidade  
 O bloco motor é adaptável a todos os braços e batedeiras  
 Braço triturador, batedor e lâminas de aço inoxidável  
 Colocação e desmontagem dos braços fácil e instantânea, sem necessidade de utilizar ferramentas  
 Prepara purés, cremes e todo o tipo de milhos



**Regulador de velocidad variable para un ajuste visual**

Régulateur de vitesse variable pour un réglage visuel  
 Variable speed controller for visual adjustment



**Botón de uso continuo**

Bouton d'utilisation continue  
 Continuous use button



**Brazo de fácil desmontaje en acero inoxidable**

Bras en acier inoxydable facilement démontable  
 Easy to remove arm made of stainless steel



**Cuchilla de gran calidad para un óptimo trabajo**

Lame de grande qualité pour un travail optimal  
 High-quality blade for optimum work

**Serie 220**

**Batidora para uso discontinuo** · Mixeur pour une utilisation discontinue · Mixer für diskontinuierliche Verwendung · Blender for discontinuous use  
Batedeira para uso descontinúo

**Velocidad Fija · Fixed Speed****Batidor Profesional Velocidad Fija**

Mixer Professionnelle Vitesse Fixe  
Profi- mixer, Festschwindigkeit  
Professional immersion blender fixed speed  
Batedeira Profissional Velocidade Fixa

Ref	€	W	Pack
69722	187,30	220	1

**Velocidad Variable · Variable Speed****Batidor Profesional Velocidad Variable**

Mixer Professionnelle vitesse variable  
Profi- mixer, variable Geschwindigkeit  
Professional immersion blender variable speed  
Batedeira Profissional Velocidade variável

Ref	€	W	Pack
69723	200,30	220	1

Ref	Tensión/Voltage	Potencia/Power	Velocidad/Speed	Capacidad/Capacity	L.Brazo/Arm length	Peso/Weight
69722	220-240 V / 50-60 Hz	200 W	20.000 r.p.m	10 L	16 cm	1,50 Kg
69723	220-240 V / 50-60 Hz	200 W	4.000 - 20.000 r.p.m	10 L	16 cm	1,50 Kg

**Accesorios**

Accessoires · Zubehör · Accessories · Acessórios

**Brazo triturador**

Pied mixeur  
Rohr  
Shaft tube  
Pé triturador

Ref	€	L (cm)	Pack
69816	95,20	16	1

**Brazo batidor**

Fouet mélangeur  
Rührbesen  
Whisk  
Pé amassadora

Ref	€	L (cm)	Pack
69815	133,20	18,5	1

**Serie 350**

Batidora para uso continuo · Mixeur pour une utilisation continue · Mixer für kontinuierlichen Gebrauch · Blender for continuous use  
 Batedeira para uso contínuo

**Velocidad Fija · Fixed Speed**

**Batidor Profesional Velocidad Fija**

Mixer Professionnelle Vitesse Fixe  
 Profi- mixer, Festdrehzahl  
 Professional immersion blender fixed speed  
 Batedeira Profissional Velocidade Fixa

	Ref	€	Brazo (cm)	Pack
<b>A</b>	69761	240,40	20	1
<b>B</b>	69762	250,40	25	1
<b>C</b>	69763	260,40	30	1
<b>D</b>	69764	275,40	40	1
<b>E</b>	69765	295,40	50	1



**Velocidad Variable · Variable Speed**



**Batidor Profesional Velocidad Variable**

Mixer Professionnelle vitesse variable  
 Profi- mixer, variable Geschwindigkeit  
 Professional immersion blender variable speed  
 Batedeira Profissional Velocidade variável

	Ref	€	Brazo (cm)	Pack
<b>A</b>	69771	253,40	20	1
<b>B</b>	69772	263,40	25	1
<b>C</b>	69773	273,40	30	1
<b>D</b>	69774	288,40	40	1
<b>E</b>	69775	308,40	50	1



Ref	Tensión/Voltage	Potencia/Power	Velocidad/Speed	Capacidad/Capacity	L.Brazo/Arm length	Composición./Comp.	Peso/Weight
69761	220-240 V / 50-60 Hz	350 W	16.000 r.p.m	15 L	20 cm	69735: Motor/Motor 69820: Brazo/Arm	2,95 Kg
69762	220-240 V / 50-60 Hz	350 W	16.000 r.p.m	20 L	25 cm	69735: Motor/Motor 69825: Brazo/Arm	3,00 Kg
69763	220-240 V / 50-60 Hz	350 W	16.000 r.p.m	30 L	30 cm	69735: Motor/Motor 69830: Brazo/Arm	3,80 Kg
69764	220-240 V / 50-60 Hz	350 W	16.000 r.p.m	80 L	40 cm	69735: Motor/Motor 69840: Brazo/Arm	4,00 Kg
69765	220-240 V / 50-60 Hz	350 W	16.000 r.p.m	120 L	50 cm	69735: Motor/Motor 69850: Brazo/Arm	4,20 Kg
69771	220-240 V / 50-60 Hz	350 W	4.000 - 16.000 r.p.m	15 L	20 cm	69736: Motor/Motor 69820: Brazo/Arm	2,95 Kg
69772	220-240 V / 50-60 Hz	350 W	4.000 - 16.000 r.p.m	20 L	25 cm	69736: Motor/Motor 69825: Brazo/Arm	3,00 Kg
69773	220-240 V / 50-60 Hz	350 W	4.000 - 16.000 r.p.m	30 L	30 cm	69736: Motor/Motor 69830: Brazo/Arm	3,80 Kg
69774	220-240 V / 50-60 Hz	350 W	4.000 - 16.000 r.p.m	80 L	40 cm	69736: Motor/Motor 69840: Brazo/Arm	4,00 Kg
69775	220-240 V / 50-60 Hz	350 W	4.000 - 16.000 r.p.m	120 L	50 cm	69736: Motor/Motor 69850: Brazo/Arm	4,20 Kg

Velocidad Fija · Fixed Speed

Velocidad Variable · Variable Speed



**Serie 500**

**Batidora para uso continuo e intensivo** · Mixeur pour une utilisation continue et intensive · Mixer für kontinuierlichen und intensiven Gebrauch  
 Blender for continuous and intensive use · Batedeira para uso contínuo e intensivo

**Velocidad Fija · Fixed Speed**

**Batidor Profesional Velocidad Fija**

Mixer Professionnelle Vitesse Fixe  
 Profi-mixer, Festdrehzahl  
 Professional immersion blender fixed speed  
 Batedeira Profissional Velocidade Fixa

	Ref	€	Brazo (cm)	Pack
<b>A</b>	69781	254,00	20	1
<b>B</b>	69782	264,00	25	1
<b>C</b>	69783	274,00	30	1
<b>D</b>	69784	289,00	40	1
<b>E</b>	69785	309,00	50	1



**Velocidad Variable · Variable Speed**



**Batidor Profesional Velocidad Variable**

Mixer Professionnelle vitesse variable  
 Profi-mixer, variable Geschwindigkeit  
 Professional immersion blender variable speed  
 Batedeira Profissional Velocidade variável

	Ref	€	Brazo (cm)	Pack
<b>A</b>	69791	265,50	20	1
<b>B</b>	69792	275,50	25	1
<b>C</b>	69793	285,50	30	1
<b>D</b>	69794	300,50	40	1
<b>E</b>	69795	320,50	50	1



	Ref	Tensión/Voltage	Potencia/Power	Velocidad/Speed	Capacidad/Capacity	L. Brazo/Arm length	Composición/Comp.	Peso/Weight
Velocidad Fija · Fixed Speed	69781	220-240 V / 50-60 Hz	500 W	16.000 r.p.m	30 L	20 cm	69750: Motor/Motor 69820: Brazo/Arm	3,55 Kg
	69782	220-240 V / 50-60 Hz	500 W	16.000 r.p.m	40 L	25 cm	69750: Motor/Motor 69825: Brazo/Arm	3,60 Kg
	69783	220-240 V / 50-60 Hz	500 W	16.000 r.p.m	60 L	30 cm	69750: Motor/Motor 69830: Brazo/Arm	4,40 Kg
	69784	220-240 V / 50-60 Hz	500 W	16.000 r.p.m	100 L	40 cm	69750: Motor/Motor 69840: Brazo/Arm	4,60 Kg
	69785	220-240 V / 50-60 Hz	500 W	16.000 r.p.m	140 L	50 cm	69750: Motor/Motor 69850: Brazo/Arm	4,80 Kg
Velocidad Variable · Variable Speed	69791	220-240 V / 50-60 Hz	500 W	4.000 - 16.000 r.p.m	30 L	20 cm	69751: Motor/Motor 69851: Brazo/Arm	3,55 Kg
	69792	220-240 V / 50-60 Hz	500 W	4.000 - 16.000 r.p.m	40 L	25 cm	69751: Motor/Motor 69825: Brazo/Arm	3,60 Kg
	69793	220-240 V / 50-60 Hz	500 W	4.000 - 16.000 r.p.m	60 L	30 cm	69751: Motor/Motor 69830: Brazo/Arm	4,40 Kg
	69794	220-240 V / 50-60 Hz	500 W	4.000 - 16.000 r.p.m	100 L	40 cm	69751: Motor/Motor 69840: Brazo/Arm	4,60 Kg
	69795	220-240 V / 50-60 Hz	500 W	4.000 - 16.000 r.p.m	140 L	50 cm	69751: Motor/Motor 69850: Brazo/Arm	4,80 Kg

**New**

**Accesorios**

Accessoires · Zubehör · Accessories · Acessórios

**SERIE 350**



**Motor batidor Profesional SERIE 350**

Moteur mixer Professionnelle SÉRIE 350

Professioneller Mixer Motor, SERIE 350

Professional immersion blender motor, SERIE 350

Motor bateadeira Profissional SÉRIE 350

	Ref	€	W	Pack	
<b>A</b>	69735	135,40	350	1	<b>Velocidad Fija</b> · Fixed Speed
<b>B</b>	69736	148,40	350	1	<b>Velocidad Variable</b> · Variable Speed

**SERIE 500**



**Motor batidor Profesional SERIE 500**

Moteur mixer Professionnelle SÉRIE 500

Professioneller Mixer Motor, SERIE 500

Professional immersion blender motor SERIE 500

Motor bateadeira Profissional SÉRIE 500

	Ref	€	W	Pack	
<b>A</b>	69750	149,00	500	1	<b>Velocidad Fija</b> · Fixed Speed
<b>B</b>	69751	160,50	500	1	<b>Velocidad Variable</b> · Variable Speed

**Brazo triturador**

Pied mixeur

Rohr

Shaft tube

Pé triturador

	Ref	€	L (cm)	Pack
<b>A</b>	69820	105,00	20	1
<b>B</b>	69825	115,00	25	1
<b>C</b>	69830	125,00	30	1
<b>D</b>	69840	140,00	40	1
<b>E</b>	69850	160,00	50	1
<b>F</b>	69824	145,00	25	1



# Batidora Brazo

· Semiprofessional use ·



### Batidora Picadora LACOR

Mixeur hacheur LACOR  
Rühr- und Zerkleinerungsgerät, LACOR  
Lacor blender chopper  
Batedeira picadora Lacor

Ref	€	Pack
61671	68,80	1



### Batidora LACOR

Mixeur LACOR  
Mixer, LACOR  
LACOR blender  
Batedeira LACOR

Ref	€	Pack
61681	60,20	8

Ref	Tensión/Voltage	Potencia/Power	Velocidad/Speed	Capacidad/Capacity	Velocidad/Speed	L.brazo/Shaft leng	Peso/Weight
61671	220-240 V / 50-60 Hz	700 W	9.000 - 16.000 r.p.m.	750 ml (mincer) / 500 ml (Glas)	SLOW / TURBO	23 cm	1,45 Kg
61681	220-240 V / 50-60 Hz	700 W	9.000 - 16.000 r.p.m.	750 ml (mincer) / 500 ml (Glas)	SLOW / TURBO	23 cm	1,10 Kg

## Accesorios

Accessoires · Zubehör · Accessories · Acessórios

### Picadora

Hachoir  
Fleischwolf  
Mincer  
Picadora



Ref	€	Pack
R61671A	10,00	1

### Pie batidor extra largo

Pied de mixeur extra-long  
Lander Stabmixer  
Extra-long blender shaft  
Pé batedeira extralargo



Ref	€	L (cm)	Pack
R61671D	20,80	27	1

### Batidor varillas

Fouet multibrins  
Rührstäbe  
Wire whisk  
Batedeira varetas



Ref	€	Pack
R61671B	10,90	1

### Soporte pared

Support mural  
Wandhalterung  
Wall support  
Suporte de parede



Ref	€	Pack
R61671F	0,90	1



· Professional use ·

**bamix®**



**Batidor eléctrico**

Mixer  
Elektro-mixer  
Electric mixer  
Batedeira eléctrica

Ref	€	cuchillas	Pack
61672	256,90	4	1
61673	401,30	4	1

**Accesorios**

Accessoires · Zubehör · Accessories · Acessórios

**Grupo pulverizador**

Broyeur  
Mahleinheit  
Pulverizing unit  
Conjunto pulverizador



Ref	€	L	Pack
61674	36,70	0,25	12

**Grupo cortador 5 cuchillas**

Combiné râpeur  
Schneide-/Zubereitungseinheit  
Cutting/preparing unit  
Conjunto cortador 5 lâminas



Ref	€	L	Pack
61675	151,00	0,50	8

Ref	Tensión/Voltage	Potencia/Power	Velocidad/Speed	Capacidad/Capacity	Inmersión/Inmersion	Altura/Height
61672	220-240 V / 50-60 Hz	200 W	14.000 - 18.000 r.p.m.	750 ml (mincer) / 500 ml (Glas)	25 cm	39,5 cm
61673	220-240 V / 50-60 Hz	350 W	18.000 - 22.000 r.p.m.	750 ml (mincer) / 500 ml (Glas)	35 cm	49,5 cm

· Household use ·



**2 velocidades. Cuchilla fija**

2 vitesses. Lame fixe  
2 Geschwindigkeiten. Feststehendes Schneidblatt  
2 speed settings. Fixed blade  
2 velocidades. Lâmina fixa

**Batidor eléctrico + Vaso**

Mixer Électrique + Verre  
Elektro-mixer + Glas  
Electric mixer + Glass  
Batedeira eléctrica + Copo

Ref	€	Pack
61676	45,40	6

Ref	Tensión/Voltage	Potencia/Power	Capacidad/Capacity	Peso/Weight
61676	220-240 V / 50-60 Hz	400 W	500 ml (max.)	880 g



## Picadoras Carne



**Incluyen 3 discos perforados de acero inoxidable**  
**Incluyen 4 accesorios extra (Kibbe incluido)**  
**Totalmente desmontables para facilitar su limpieza**

Inclut 3 disques perforés en acier inoxydable  
 Inclut 4 accessoires supplémentaires (kebbeh inclus)  
 Totalement démontable pour faciliter son nettoyage

3 perforierten Edelstahlscheiben  
 Dazu gehören 4 Zubehörteile (inkl. Kibbeh)  
 Für eine einfache Reinigung, komplett auseinandernehmbar

Includes 3 stainless steel perforated discs  
 Includes 4 extra accessories (Kibbe included)  
 Can be fully disassembled for easy cleaning

Inclui 3 discos perfurados de aço inoxidável  
 Inclui 4 acessórios extras (Kibbe inclusive)  
 Totalmente desmontável para facilitar a sua limpeza

· Professional use ·



**Picadora estable y resistente. Cuerpo de aluminio fundido**  
**Engranajes interiores y exteriores metálicos para una mayor resistencia**  
**Función reverse (REV) para cambiar el sentido de giro**  
**Tres distintos tamaños de carne homogéneos (Ø3-5-8 mm)**  
**Tres tamaños de embutidos como salchichas, chorizos,...**

Hachoir stable et résistant. Corps en fonte d'aluminium  
 Engrainages intérieurs et extérieurs métalliques pour une plus grande résistance  
 Fonction reverse (REV) pour changer le sens de rotation  
 Trois différentes tailles de viande homogènes (Ø3-5-8 mm)  
 Trois tailles de charcuteries farcies telles que des saucisses, chorizos,...

Stabiler Fleischwolf und Beanspruchbarer. Aluminiumgußkörper  
 Innere und äußere Metallgetriebe für eine höhere Widerstandsfähigkeit  
 Zur Umkehrung der Drehrichtung (REV) drücken  
 Drei verschiedene homogene Hackgrößen (Ø3-5-8 mm)  
 Drei verschiedene Wurstgrößen für Würstchen, Chorizo usw.

Stable and resistant mincer. Molten aluminium body  
 Interior and exterior metal gear teeth for improved resistance  
 Function "reverse" (REV) to change the spin direction  
 Three different sizes of homogeneous meat (Ø3-5-8 mm)  
 Three sizes of sausages such as salchicha (fresh sausage) and chorizo...

Máquina de picar carne estável e resistente. Corpo em alumínio fundido  
 Engrenagens interiores e exteriores metálicas para uma maior resistência  
 Função Reverse (REV) para alterar o sentido de rotação  
 Três distintos tamanhos de carne homogéneos (Ø3-5-8 mm)  
 Três tamanhos de enchidos, para salchichas, chouriços,...

### Picadora Eléctrica de carne PRO

Hachoir électrique pour viande  
 Elektrischer Fleischwolf  
 Electric meat mincer  
 Picadora eléctrica de carne

Ref	€	Pack
69368	479,90	1

Ref	Tensión/Voltage	Potencia/Power	Velocidad/Speed	Capacidad/Capacity	Dimensiones/Sizes	Peso/Weight
69368	220-240 V / 50-60 Hz	250 W	12.000 r.p.m	85 Kgr/h	41x19,5x35 cm	12,30 Kg

• Semiprofessional use •



**Incluyen 3 discos perforados de acero inoxidable**  
**Incluyen 4 accesorios extra (Kibbe incluido)**  
**Totalmente desmontables para facilitar su limpieza**

Inclut 3 disques perforés en acier inoxydable  
 Inclut 4 accessoires supplémentaires (kebbeh inclus)  
 Totalement démontable pour faciliter son nettoyage

3 perforierten Edelstahlscheiben  
 Dazu gehören 4 Zubehörteile (inkl. Kiebbeh)  
 Für eine einfache Reinigung, komplett auseinandernehmbar

Includes 3 stainless steel perforated discs  
 Includes 4 extra accessories (Kibbe included)  
 Can be fully disassembled for easy cleaning

Inclui 3 discos perforados de aço inoxidável  
 Inclui 4 acessórios extras (Kibbe inclusive)  
 Totalmente desmontável para facilitar a sua limpeza



**Picadora Eléctrica de carne CHOP**

Hachoir électrique pour viande  
 Elektrischer Fleischwolf  
 Electric meat mincer  
 Picadora eléctrica de carne

Ref	€	Pack
69369	94,50	1

**Picadora Eléctrica de carne**

Hachoir électrique pour viande  
 Elektrischer Fleischwolf  
 Electric meat mincer  
 Picadora eléctrica de carne

Ref	€	Pack
69068	188,30	1



Ref	Tensión/Voltage	Potencia/Power	Capacidad/Capacity	Dimensiones/Sizes	Peso/Weight
69068	220-240 V / 50-60 Hz	800 W	1 Kg/min	36x36x18 cm	5,13 Kg
69369	220-240 V / 50-60 Hz	1000 W	1 Kg/min	38,6x16,6x34,2 cm	3,70 Kg

• Household use •

**Picadora eléctrica cristal**

Hachoir électrique verre  
 Elektrofleischwolf, glas  
 Glass electric mincer  
 Picadora eléctrica de vidro

Ref	€	Pack
69063	53,90	1



**Obtiene un tamaño de carne homogéneo. No transmite sabores**

Obtient une taille de viande homogène. Ne transmet pas de saveurs  
 Homogene Fleischgröße. Ohne Geschmacksübertragung  
 Gives a uniform size of meat. Does not transmit flavours  
 Obtém um tamanho de carne homogéneo. Não transmite sabores

Ref	Tensión/Voltage	Potencia/Power	Capacidad/Capacity	Dimensiones/Sizes	Peso/Weight
69063	220-240 V / 50-60 Hz	160 W (cuchilla Ø100 mm)	1,00 L (max)	19x16x23 cm	1,60 Kg

## Cortadoras fiambre

· Professional use ·

**Cortadora eléctrica de fiambre**

Trancheuse électrique de charcuterie  
Elektrische Aufschnittmaschine  
Electric cold meat cutter  
Cortadora eléctrica de fiambre

Ref	€	Pack
69125	529,30	1
69130	904,30	1

**Máquina de alto rendimiento**

**Estructura de aluminio, transmisión por correa, pantalla protectora y cabezal ajustable de suave deslizamiento**  
**Cuchilla de corte de Ø 250 mm fabricada en Italia con acero inoxidable de alta calidad**

Machine à haut rendement

Structure en aluminium, transmission par courroie, écran de protection et tête ajustable avec glissement doux

Lame de coupe de Ø 250 mm fabriquée en Italie avec de l'acier inoxydable de grande qualité

Leistungstarker Apparat Aluminiumstruktur, Riemenantrieb, Schutzabschirmung und Kopfteil stufenlos einstellbar

Italienische Messer aus rostfreiem Edelstahl mit einer Schnittbreite von Ø 250 mm

High performance machine

Aluminium frame, belt drive, protective screen and adjustable sliding head 250 mm diameter slicer blade made in Italy with high quality stainless steel

Máquina de alto rendimento

Estrutura de alumínio, transmissão por correia, barreira protetora e cabeça ajustável de deslizamento suave

Lâmina de corte de Ø 250 mm, fabricada em Itália em aço inoxidável de alta qualidade

Ref	Tensión/Voltage	Potencia/Power	Cuchilla/Blade	Esp. corte/Slice thick.	Dimensiones/Sizes	Peso/Weight
69125	220-240 V / 50-60 Hz	150 W	Ø250 mm / 10"	0 - 11 mm	48x39x36 cm	15,0 Kg
69130	220-240 V / 50-60 Hz	250 W	Ø300 mm / 12"	0 - 13 mm	60x58x44 cm	24,3 Kg

· Household use ·

**Cortadora eléctrica de fiambre HOME**

Trancheuse électrique de charcuterie Home  
Home-Elektrische Aufschnittmaschine  
Home electric cold meat cutter  
Cortadora eléctrica de fiambre Home

Ref	€	Pack
69118	95,10	1

**Diámetro: 190 mm / 7,5"****Transmisión por engranaje****Cuerpo de metal****Rango de espesor ajustable de 0 - 15 mm****Bandeja inoxidable abatible y fácil limpieza**

Diamètre: 190 mm / 7,5"

Transmission pour engrenage

Corps métallique

Épaisseur réglable de 0 - 15 mm

Plateau inoxydable rabattable et facile à nettoyage

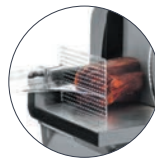

Durchmesser: 190 mm / 7,5"

Zahnradantrieb

Metallgehäuse verstellbarer

Schneidstärkenbereich 0 bis 15 mm

Leicht zu reinigende, abklappbare Nirostplatte.



Diameter: 190 mm / 7,5"

Gear transmission. Metal body. The range of

thickness adjusting is from 0 - 15 mm

Tilted trolley for easy cleaning.

Diámetro: 190 mm / 7,5"

Engrenagem

Corpo d metal

Ajustável espessura faixa 0 - 15 mm

Bandeja de aço dobrável para fácil limpeza

Ref	Tensión/Voltage	Potencia/Power	Cuchilla/Blade	Esp. corte/Slice thick.	Dimensiones/Sizes	Peso/Weight
69118	220-240 V / 50-60 Hz	150 W	Ø190 mm / 7,5"	0 - 15 mm	37,3x27,9x27,5 cm	4,51 Kg



## Mandolinas · Cortadoras

· Semiprofessional use ·



6 cortes en 1  
6 coupes dans 1  
6 Schnitte auf 1  
6 cuts in 1  
6 cortes em 1

Boca ancha  
Boc large  
Breites Mundstück  
Wide chute  
Boca larga

71x53 mm



**Versátil, puede cortar y rallar gran cantidad de verduras y frutas a gran velocidad**

**Completamente seguro, dispone de varios interruptores de seguridad**  
**Fácil de limpiar gracias a las bandejas y cuchillas extraíbles**

Versatile, elle peut couper et râper une grande quantité de fruits et de légumes très rapidement

Totalement sûre, dispose de plusieurs interrupteurs de sécurité  
Facile à nettoyer grâce aux plateaux et aux lames extractibles

Vielseitig, schneidet und raspelt im Handumdrehen große Mengen an Obst und Gemüse

Absolut sicher, Ist mit mehreren Sicherheitsschaltern versehen  
Einfach zu reinigen, dank seiner herausnehmbaren Schalen und Messer

Versatile and able to cut and grate lots of fruit and vegetables at high speed  
Completely safe, equipped with several safety switches  
Easy to clean thanks to the removable trays and knives

Versátil, corta e rala grande quantidade de verduras e frutas a grande velocidade

Completamente seguro, vários interruptores de segurança  
Fácil de limpar graças às bandejas e lâminas extraíveis

**Mandolina eléctrica**

Mandoline électrique  
Elektrische mandoline  
Electric mandoline  
Mandolina eléctrica

Ref	€	Pack
61690	119,10	1

Ref	Tensión/Voltage	Potencia/Power	Cuchillas/Blades	Capacidad/Capacity	Dimensiones/Sizes	Peso/Weight
61690	220-240 V / 50-60 Hz	250 W	6 (6 cortes / cuts)	2,0 L	20,5x11,5x17 cm	2,815 Kg

· Household use ·



**5 cortes con 5 colores para tus vegetales, frutas, quesos, nueces y chocolate**  
**Un sistema de canalón con cuchilla que permite diferentes cortes**  
**Cómodo, fácil de usar, fácil de montar, fácil de cambiar cuchilla y fácil de limpiar**

5 coupes avec 5 couleurs pour vos légumes, fruits, fromages, noix et chocolat  
Un système de gouttière avec une lame qui permet différentes coupes  
Pratique, facile à utiliser, facile à monter, lame facile à changer, et facile à nettoyer

5 Schneiden mit 5 Farben für Ihr Gemüse, Obst, Käse, Nüsse und Schokolade  
Ein Rinnensystem mit Messer für verschiedene Schnitte  
Bequem, leicht zu bedienen, leicht zu montieren, einfacher Messerwechsel und leicht zu reinigen

5 cuts and 5 colours for your vegetables, fruit, cheeses, walnuts and chocolate  
A gutter system with a blade that allows different cuts  
Comfortable, easy to use, easy to assemble, easy blade changing and easy to clean

5 cortes com 5 cores para os seus vegetais, frutas, queijos, nozes e chocolate  
Um sistema de canal com lâmina que permite diferentes cortes  
Cómodo, fácil de utilizar e de montar. Lâmina facilmente intercambiável. Fácil limpeza

**Corta vegetales eléctrico**

Électrique hachoir légumes  
Elektrischer Gemüseschneider  
vegetables electrical cutter  
Corta vegetales eléctrica

Ref	€	Pack
69115	60,60	1

Ref	Tensión/Voltage	Potencia/Power	Cuchillas/Blades	Dimensiones/Sizes	Peso/Weight
69115	220-240 V / 50-60 Hz	150 W	5	24,5x22,5x19,5 cm	1,89 Kg



• Household use •

Rendimiento Profesional  
Professional Performance



**New**



**Corta frutas y verduras en forma de espaguetis**  
**Consigue espaguetis de calabacín, zanahoria, patata, remolacha... 100% naturales**  
**Alimentación saludable y baja en hidratos de carbono**  
**3 cuchillas de acero inoxidable para diferentes tamaños de espiral**  
**Práctico recipiente transparente de 1L (libre de BPA) que recoge los espirales de los alimentos**  
**Fácil de desmontar y limpiar. Todas las piezas desmontables pueden lavarse en el lavavajillas**

Coupe les fruits et les légumes en forme de spaghettis  
 Obtenez des spaghettis de courgette, carotte, pomme de terre, betterave...100% naturelles  
 Alimentation saine et faible en hydrates de carbone  
 3 lames en acier inoxydable pour différentes tailles de spirales  
 Pratique récipient transparent (sans BPA - 1L), qui recueille les spirales des aliments  
 Simple à démonter pour un nettoyage facile. Toutes les pièces démontables peuvent être lavées au lave-vaisselle

Spaghetti-Schnitt für Obst und Gemüse  
 Spaghetti aus Kürbis, Möhren, Kartoffeln, Rote Bete usw. zubereiten Vollkommen natürlich  
 Gesunde kohlenhydratarme Ernährung  
 3 Messer aus Edelstahl für verschiedene Spiralgrößen  
 Praktischer Behälter aus durchsichtigem Kunststoff (ohne BPA - 1L) fängt die Lebensmittelspiralen auf  
 Einfach abnehmbar und leicht zu reinigen. Alle abnehmbaren Teile sind spülmaschinengeeignet

Slice fruit and vegetables into spaghetti shapes  
 Make courgette, carrot, potato and beetroot noodles...100% natural  
 Healthy and low carbohydrate food  
 3 stainless steel blades for different spiral sizes  
 Practical transparent container (BPA-free - 1L) collectsthe food spirals  
 Easy to disassemble for easy cleaning. All removable parts are dishwasher safe

Corta frutas e verduras em forma de esparguete  
 Para fazer esparguete de courgete, cenoura, batata, beterraba...100% naturais  
 Alimentação saudável e baixa em hidratos de carbono  
 3 lâminas de aço inoxidável para diferentes tamanhos de espiral  
 Prático recipiente transparente (sem BPA - 1L), para recolher as espirais dos alimentos  
 Simples de desmontar para uma limpeza mais fácil. Todas as peças desmontáveis se podem lavar na máquina de lavar louça

**Tallarines de verdura 100% naturales**  
 Vegetable noodles 100% natural



**Cortador en espiral eléctrico**

Coupe de légumes électrique  
 Elektrisch Gemüseschneidemaschine  
 Electric vegetables cutter  
 Cortador de verdura eléctrico

Ref	€	W	L	Pack
69370	76,90	80	1,0	1

Ref	Tensión/Voltage	Potencia/Power	Cuchillas/Blades	Capacidad/Capacity	Dimensiones/Sizes	Peso/Weight
69370	220-240 V / 50-60 Hz	80 W	3	1,0 L	17,5x13,5x36 cm	1,61 Kg

• Household use •

8 Funciones en uno  
8 Functions in one



Jarra batidora  
Blender jug



Conj. batidor / montador  
Blending / whipping unit



Molinillo + Tapa  
Grinder + Lid



Discos corte  
Cutting discs



Conj. exprimidor  
Juicer attachment



Cortador mini  
Mini cutter



Conj. licuadora  
Smoothie unit



Corte con cuchilla  
Cutting with blades



**Robot Multifunción**

Robot Multifonctions  
Multifunktions-Roboter  
Multifunction Robot  
Robô Multifuncionais

Ref	€	Pack
69079	146,90	1

Ref	Tensión/Voltage	Potencia/Power	Velocidades/Speeds	Capacidad/Capacity	Dimensiones/Sizes	Peso/Weight
69079	220-240 V / 50-60 Hz	800 W	10	1,50 L	24x22x40 cm	6,50 Kg

• Household use •

**New**



**Molinillo eléctrico Inox**

Moulin électrique en inox  
Elektrische Mühle aus Edelstahl  
St steel electric grinder  
Moinho elétrico Inox

Ref	€	Pack
69385	30,10	1

**Ideal para moler café y otros productos como semillas, hierbas, frutos secos, cereales, sal, pimienta, azúcar o especias**  
**Cuchillas de acero inoxidable de gran resistencia y durabilidad para un molido fino y preciso**  
**Sistema de bloqueo de seguridad, las cuchillas sólo se activan cuando la tapa está perfectamente cerrada**  
**Capacidad de 60 g, equivale a 9 tazas de café**

Idéal pour mouler le café et d'autres produits tels que les graines, les herbes, les fruits secs, les céréales, le sel, le poivre, le sucre ou les épices.  
Lames en acier inoxydable d'une grande résistance et durabilité pour une mouture fine et précise  
Système de blocage de sécurité : les lames s'activent uniquement lorsque le couvercle est parfaitement fermé  
Capacité de 60 g, soit l'équivalent de 9 tasses de café

Perfekt zum Mahlen von Kaffee oder anderen Produkten wie Kerne, Kräuter, Trockenobst, Getreide, Salz, Pfeffer, Zucker oder Gewürze  
Sehr widerstandsfähige und rostfreie Stahlklingen mit hoher Lebensdauer für feines und gleichförmiges Mahlgut  
Mit Sicherheitssperre - Klingen bewegen sich nur bei fest geschlossenem Deckel  
Fassungsvermögen: 60g (ca. 9 Tassen Kaffee)

Perfect for grinding coffee or other products like seeds, herbs, nuts, grains, salt, pepper, sugar or spices  
Long lasting high strength stainless steel blades provide fine and precise grinding  
Safety blocking system. The blades can only be activated when the lid is completely closed  
60 g capacity, equivalent to 9 cups of coffee

Ideal para moer café e outros produtos, como sementes, ervas, frutos secos, cereais, sal, pimenta, açúcar e especiarias  
Lâminas de aço inoxidável, de grande resistência e durabilidade, para uma moagem fina e de precisão  
Sistema de bloqueio de segurança: as lâminas só giram com a tampa corretamente fechada  
Capacidade para 60 g, o que equivale a 9 chávenas de café

Ref	Tensión/Voltage	Potencia/Power	Capacidad/Capacity	Dimensiones/Sizes	Peso/Weight
69385	220-240 V / 50-60 Hz	200 W	60 g	Ø10x18 cm	780 g

# Deshidratadores

· Professional use ·



**Una forma natural y sencilla de conservar frutas, verduras, setas, carnes, pescados, etc... con todos sus nutrientes durante más tiempo**  
**Extrae el agua, impidiendo su descomposición por microorganismos, conservandolos sin perder sus valores**  
**Calentamiento 3D: Dispone de un sistema de giro 360° automático, en el que el aire circula por su interior de manera uniforme, penetrando por los orificios de las bandejas**  
**Contiene 5 bandejas desmontables que permiten introducir alimentos diferentes de gran tamaño, elaboración de yogures, etc..**  
**Accesorios adicionales para deshidratar salsas y realizar galletas**

## Deshidratador de alimentos PRO

Deshydrateur des aliments  
 Obsttrockner, elektrisch  
 Food dehydrator  
 Desidratador de alimentos

Ref	€	Pack
69523	157,60	1

Une façon naturelle et simple de conserver les fruits, les légumes, les champignons, les viandes, les poissons, etc. en gardant tous leurs nutriments pendant plus longtemps  
 Extrait l'eau, empêchant ainsi leur décomposition due à des microorganismes, en les conservant sans perdre leurs valeurs  
 Chauffe 3D : dispose d'un système de rotation à 360° automatique à l'intérieur duquel l'air circule uniformément, en pénétrant par les orifices des plateaux  
 Contient 5 plateaux démontables qui permettent l'introduction de différents aliments de grande taille, l'élaboration de yogourts, etc  
 Accessoires supplémentaires pour déshydrater des sauces et réaliser des biscuits

**Accesorios** · Accessoires · Zubehör · Accessories · Acessórios

## Láminas antiadherentes

Feuilles antiadhésif  
 Antihaft-Blätter  
 Non-stick sheets  
 Lâminas antiaderentes



Ref	€	cm	Unidades	Pack
66746	7,30	30x40	3	1

Obst, Gemüse, Pilze, Fisch, Fleisch usw. kann so auf einfache und natürliche Weise haltbar gemacht werden  
 Nahrungsmittel  
 Temperatur kann bis auf 70°C geregelt werden  
 Rundum-Beheizung: Gleichmäßige Hitzeverteilung durch selbstdrehende Aufsätze mit luftdurchlässigen Böden  
 Enthält 5 entnehmbare Dörraufsätze zum Versammeln unterschiedlicher Lebensmittel in großen Stücken, Zubereiten von Joghurt usw  
 Zubehör zur Trocknung von Saucen und Bereitung von Keksen

A natural and easy way to preserve fruits, vegetables, mushrooms, meats, fish, etc... with all their nutrients for more time  
 Extracts water from foods, preventing spoilage due to microorganisms and preserving them without losing their values  
 3D Heating: It has a 360° automatic rotation system, in which the air circulates evenly through its interior, penetrating through the holes in the trays  
 Contains 5 removable trays that can be used with different sized foods, to make yoghurt, etc  
 Additional accessories for dehydrating sauces and making biscuits

· Semiprofessional use ·

**New**



Incluye Recetario  
 Recipe Book included  
 · Mi taller de Bienestar ·  
 Lauri Bengochea

Uma forma simples e natural de conservar frutas, verduras, cogumelos, carnes, peixes, etc., com todos os nutrientes durante mais tempo  
 Extrai a água dos alimentos, impedindo assim a sua decomposição devido aos microorganismos, e conservando-os sem que percam as suas qualidades  
 Aquecimento 3D: equipado com um sistema de giro de 360° automático, em que o ar circula no seu interior de maneira uniforme, penetrando nos orifícios das bandejas  
 Inclui 5 bandejas desmontáveis, que permitem introduzir alimentos diferentes e de grande tamanho, preparar iogurtes, etc.  
 Acessórios adicionais para desidratar molhos e elaborar bolachas

## Deshidratador giratorio TERRA

Déshydrateur tournant  
 Drehdehydrator  
 Rotating dehydrator  
 Desidratador giratório



Ref	€	Pack
69223	99,50	1



• Household use •



**Deshidratador de alimentos**

Deshydrateur des aliments  
Obsttrockner, elektrisch  
Food dehydrator  
Desidratador de alimentos

Ref	€	Pack
69123	58,30	4

Ref	Tensión/Voltage	Potencia/Power	Temperatura/Temp.	Capacidad/Capacity	Dimensiones/Sizes	Peso/Weight
69523	220-240 V / 50-60 Hz	800 W	29°C - 73°C (max)	6 bandejas / Trays	36x47x26 cm	5,50 Kg
69223	220-240 V / 50-60 Hz	500 W	70°C (max)	5 bandejas / Trays	Ø33x22 cm	2,80 Kg
69123	220-240 V / 50-60 Hz	245 W	70°C (max)	5 bandejas / Trays (13,5 L)	Ø32x27 cm	2,45 Kg

## Cocedor de vapor

• Household use •



**Cocedor al vapor eléctrico**

Cuiseur vapeur électrique  
Elektrisches Dampfkochgerät  
Electric steam cooker  
Panela de cocção a vapor eléctrica

Ref	€	Pack
69121	69,40	2

Ref	Tensión/Voltage	Potencia/Power	Temperatura/Temp.	Capacidad/Capacity	Dimensiones/Sizes	Peso/Weight
69121	220-240 V / 50-60 Hz	1000 W	100°C (max)	12 L	41x35x26,57 cm	3,16 Kg

Numeración en bandejas  
Numbering in trays

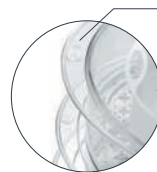

Cubeta para cocinar arroz  
Container for cooking rice

**Una forma muy saludable de cocinar los alimentos**  
**Mantiene todos los nutrientes, aromas y sabores de los alimentos**  
**Se pueden preparar varios alimentos simultáneamente sin que se mezclen sus sabores**

Une façon très saine de cuisiner les aliments  
Conserve tous les nutriments, les arômes et les saveurs des aliments  
Plusieurs aliments peuvent être préparés simultanément sans aucun mélange de saveurs

Für eine äußerst gesunde Zubereitung von Lebensmitteln.  
Nährstoffe, Geschmack und Aroma der Lebensmittel bleiben erhalten  
Zubereitung mehrerer Lebensmittel gleichzeitig möglich, ohne Geschmacksübertragung

A very healthy way of cooking food  
Retains all the nutrients, aromas and flavours of food  
You can prepare several foods simultaneously without mixing their flavours

Uma forma saudável de cozinhar os alimentos  
Conserva todos os nutrientes, aromas e sabores dos alimentos  
Permite preparar vários alimentos simultaneamente, sem que os seus sabores se misturem



# Freidoras

· Professional use ·



**Especial para todo tipo de frituras**  
**Su diseño permite freír gran cantidad de alimento y también puede cocinar al vapor**  
**Mango termo resistente**

Spécial pour tout type de friture  
 Sa conception permet de frire de grandes quantités d'aliments et elle peut également cuire à la vapeur. Manche thermorésistant

Für alle Frittierarten geeignet  
 Design für das Frittieren großer Mengen von Lebensmitteln. Auch zum Dampfkochen geeignet  
 Hitzebeständiger Handgriff

Essential for all types of fried dishes  
 Its design means it can fry a large amount of food and it can also be used as a steamer  
 Heat-resistant handle

Especial para todo o tipo de fritas  
 O seu design permite fritar uma grande quantidade de alimentos, e também cozinhar a vapor  
 Mango termorresistente

**Freidora eléctrica Profesional**

Friteuse électrique  
 Elektrische friteuse  
 Electric fryer  
 Fritadeira eléctrica

Ref	€	Pack
69169	219,30	1

Ref	Tensión/Voltage	Potencia/Power	Temperat./Temp.	Capacidad/Capacity	Cestillo/Basket	Dimensiones/Sizes	Peso/Weight
69169	220-240 V / 50-60 Hz	2500 W	50 - 190°C	6,0 L	24x20x10,5 cm	34x45x35 cm	7,50 Kg

**B**

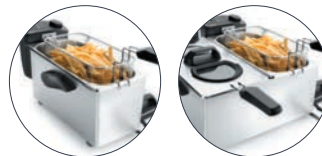

**Especial para todo tipo de frituras**  
**Mango termo resistente**  
**Contiene interruptor de seguridad y cabezal desmontable**

Spécial pour tout type de friture  
 Manche thermorésistant  
 Possède un interrupteur de sécurité et tête démontable

Für alle Frittierarten geeignet  
 Hitzebeständiger Handgriff  
 Mit Sicherheitsschalter und Abbaubarer Kopf

Essential for all types of fried dishes  
 Heat-resistant handle  
 Safety switch and Detachable head

Especial para todo o tipo de fritas  
 Mango termorresistente  
 Contém interruptor de segurança e cabeça desmontável

**A**



**Freidora eléctrica**

Friteuse électrique  
 Elektrische Friteuse  
 Electric fryer  
 Fritadeira eléctrica

Ref	€	L	Pack
<b>A</b> 69135	87,90	3,50	1
<b>B</b> 69170	176,00	3,50x2	1

Ref	Tensión/Voltage	Potencia/Power	Temperatura/Temp.	Capacidad/Capacity	Dimensiones/Sizes	Peso/Weight
69135	220-240 V / 50-60 Hz	2000 W	190°C	3,50 L	41x22x21 cm	2,70 Kg
69170	220-240 V / 50-60 Hz	4000 W	190°C	3,50 x 2 L	41x39,5x21 cm	6,60 Kg

• Semiprofessional use •



**Especial para todo tipo de frituras**  
**Mango termo resistente**  
**Gracias al grifo incorporado permite extraer fácilmente el aceite**

Spécial pour tout type de friture  
 Manche thermorésistant  
 Merci à la robinet intégré vous permet d'extraire facilement l'huile

Für alle Frittierarten geeignet  
 Hitzebeständiger Handgriff  
 Dank des eingebauten Wasserhahn können Sie leicht extrahieren Öl

Essential for all types of fried dishes  
 Heat-resistant handle  
 Thanks to the built-tap lets you easily extract oil

Especial para todo o tipo de fritos  
 Mango termorresistente  
 Graças ao toque construído permite que você facilmente extrair petróleo

**Freidora eléctrica**  
 Friteuse électrique  
 Elektrische Friteuse  
 Electric fryer  
 Fritadeira eléctrica

Ref	€	L	Pack
69134	154,20	4,00	1

Ref	Tensión/Voltage	Potencia/Power	Temperatura/Temp.	Capacidad/Capacity	Dimensiones/Sizes	Peso/Weight
69134	220-240 V / 50-60 Hz	2500 W	190°C	4,00 L	44,3x24,7x27,5 cm	2,94 Kg

• Household use •



**Dimensiones reducidas para unas prestaciones de gama alta, una pequeña gran freidora**  
**Ventana incorporada en la tapa y cubeta extraíble para la limpieza**  
**Las paredes exteriores se mantendrán frías en todo momento**

Dimensions réduites pour des prestations haut de gamme, une petite grande friteuses  
 Fenêtre intégrée dans le couvercle et cuve extractible pour le nettoyage  
 Les parois extérieures restent toujours froides

Kleine Abmessungen bei hoher Leistung, eine kleine großartige Fritteuse  
 Deckel mit Sichtfenster und herausnehmbaren Korb zur einfachen Reinigung  
 Die Außenwände bleiben jederzeit kalt

Smaller dimensions for high-end features, a small but powerful fryer  
 Window incorporated in the lid and removable tray to aid cleaning  
 The external walls will be kept cool at all times

Dimensões reduzidas para umas prestações de gama alta, uma pequena grande fritadeira  
 Janela incorporada na tampa, e cuvete extraível para facilitar a sua limpeza  
 As paredes exteriores mantêm-se frias em todo o momento

**Freidora eléctrica**  
 Friteuse électrique  
 Elektrische Friteuse  
 Electric fryer  
 Fritadeira eléctrica

Ref	€	L	Pack
69199	97,90	2,50	1

Ref	Tensión/Voltage	Potencia/Power	Temperat./Temp.	Temp./Timer	Capacidad/Capacity	Cestillo/Basket	Dimensiones/Sizes	Peso/Weight
69199	220-240 V/50-60 Hz	2800 W	130 - 190°C	0 -30 min	2,50 L	18x17x10 cm	34x29x25 cm	3,90 Kg

• Household use •



*Recetas sanas sin apenas aceite*  
*Healthy recipes with hardly oil*

**Ideal para todas aquellas personas preocupadas por una dieta saludable**  
**Permite preparar deliciosas y sanas recetas sin apenas aceite**  
**Frie, saltea, sofríe, guisa, cocina al vapor y hornea**  
**Funciona por aire caliente que reparte el aceite por todos los alimentos consiguiendo una cocción homogénea**  
**Sistema rotativo que distribuye el aire por todo el interior conservando el sabor de los alimentos**  
**Cocina en poco tiempo y no produce malos olores ni humos**  
**Cubeta con recubrimiento antiadherente de gran calidad, libre de PFOA**

Idéale pour tous ceux qui souhaitent avoir un régime alimentaire sain  
Permet de préparer des recettes délicieuses et saines presque sans huile  
Frit, saute, poêle, cuisine, cuit à la vapeur et braise.  
Fonctionne avec de l'air chaud qui distribue l'huile à travers tous les aliments, obtenant ainsi une cuisson homogène  
Système rotatif qui distribue l'air à travers tout l'intérieur, conservant ainsi la saveur des aliments  
Cuisine rapidement et ne produit ni mauvaises odeurs ni fumées  
Cuve dotée d'un revêtement antiadhésif de grande qualité, sans PFOA.

Das ideale Küchengerät für gesundheitsbewusste Genießer  
Schon mit ganz wenig Öl kreieren Sie gesunde und leckere Rezepte  
Zum Frittieren, Sieden, Dämpfen, Braten und Backen  
Arbeitet mit Heißluft-Zirkulation, die das Öl gleichmäßig im Innern verteilt und alles gut durchkocht  
Die heiße Luft zirkuliert im Innern des Geräts und erhält den vollen Geschmack  
Kocht schnell und geruchlos, raucht nicht  
Frittierkorb mit hochqualitativer Antihafbeschichtung (ohne PFOA)

Ideal for all those who are concerned about a healthy diet  
Enables you to prepare delicious and healthy recipes with hardly any oil  
Fries, sautés, sweats, stews, steams and bakes  
Works thanks to hot air that spreads the oil across the food to achieve even cooking  
Rotating system that distributes air throughout the interior, preserving the taste of food  
Cooks quickly and does not give off unpleasant odours or fumes  
Bowl with high-quality, PFOA-free non-stick coating

Ideal para todas as pessoas que querem seguir uma dieta saudável  
Permite preparar receitas deliciosas e saudáveis praticamente sem utilizar óleo  
Frita, salteia, refoga, guisa, cozinha ao vapor e assa  
Funciona utilizando ar quente, que distribui o óleo por todos os alimentos, conseguindo uma cocção homogénea  
Sistema rotativo que distribui o ar pelo interior do recipiente, conservando o sabor dos alimentos  
Cozinha em pouco tempo, e não produz fumo nem maus cheiros  
Cuvete com revestimento antiaderente, de grande qualidade, sem PFOA



**Freir**  
Fry



**Saltear**  
Saute



**Guisar**  
Cook



**Asar**  
Roast



**Hornear**  
Bake



**Cocinar al vapor**  
Steamed

**Freidora Multifunción DAIRE**

Friteuse Multifonctions  
Multifunktions Friteuse  
Multifunction fryer  
Fritadeira Multifuncionalis

Ref	€	L	Pack
69308	185,80	3,0	1

Ref	Tensión/Voltage	Potencia/Power	Temperatura/Temp.	Capacidad/Capacity	Temporiz./Timer	Dimensiones/Sizes	Peso/Weight
69308	220-240 V / 50-60 Hz	Sup.: 1000 W Inf.: 800 W Motor: 1000 W T= 1815 W	150°C - 200°C	3,0 L	0 30 min	45x34x25 cm	5,60 Kg

• Household use •

Freír sin aceite, por medio de circulación de aire caliente de alta velocidad  
Oil-free frying through high-speed hot air circulation



**Obtendrá siempre los mejores resultados gracias al temporizador y regulador temperatura**  
**Ideal para la cocina saludable, dietas de adelgazamiento y en especial para personas preocupadas por su nivel de colesterol**  
**Reduce el consumo de grasas conservando los nutrientes y sabores de los alimentos**

Vous obtiendrez toujours les meilleurs résultats grâce au minuteur et au régulateur de température  
Idéal pour une cuisine saine, des régimes amincissants et particulièrement pour les personnes soucieuses de leur niveau de cholestérol  
Réduit la consommation de graisses en conservant les nutriments et les saveurs des aliments

Immer beste Ergebnisse dank Zeituhr und Temperaturregler  
Ideal für die gesunde Küche, Diäten und insbesondere für Personen, die auf ihr Cholesterin achten  
Reduziert den Fettverbrauch und bewahrt die Nährstoffe und den Geschmack der Lebensmittel

It will always obtain the best results thanks to the timer and thermostat  
Ideal for healthy cooking, slimming diets and particularly for people concerned with their cholesterol level  
Reduces the consumption of fats, conserving the nutrients and flavours of food

Obterá sempre os melhores resultados graças ao temporizador e ao regulador de temperatura  
Ideal para a cozinha saudável, dietas de emagrecimento, e em especial para pessoas preocupadas com o seu nível de colesterol  
Reduz o consumo de gorduras conservando os nutrientes e os sabores dos alimentos

**Freidora de aire eléctrica**

Friteuse à air chaud électrique  
Elektrische Fettfreie Friteuse  
Electric air fryer  
Fritedeira de ar eléctrica

Ref	€	L	Pack
69311	155,80	2,00	1

Ref	Tensión/Voltage	Potencia/Power	Temperat./Temp.	Temp./Timer	Capacidad/Capacity	Cestillo/Basket	Dimensiones/Sizes	Peso/Weight
69311	220-240 V / 50-60 Hz	1500 W	80 - 200°C	0 - 30 min	2,00 L	16,5x14x8,5 cm	38,5x29,5x37,3 cm	5,80 Kg



## Básculas eléctricas

· Professional use ·



### Báscula electrónica con base cuadrada 150 Kg (20 g)

Balance professionnel électronique 150 Kgs. (20g)  
Elektronische Küchenwaage mit rechteckigem Oberteil 150 Kg (20g)  
Electronic bench scale w/square base 150 Kg (20g)  
Balança electrónica com base quadrada 150 Kg (20 g)

Ref	€	Pack
61700	941,40	1

**Plataforma inoxidable 53x44cm (21"x17")**  
**Cable conexión 230V 50 Hz**  
**Batería interna recargable (Autonomía 15 días)**  
**Cabezal orientable y abatible**  
**Cuerpo aluminio fundido**  
**Patas de apoyo regulables**  
**Visor de nivel, planitud**  
**Avisador acústico de sobrecarga**  
**Teclado intuitivo y de fácil uso**  
**Funciones de calculadora**  
**Acumulación de importes**  
**Unidades de medida (Kgs., Oz., Libras)**  
**Función de tara**  
**Libro de instrucciones en 7 idiomas**

Plateau Inoxydable 53x44 cm  
Câble connexion 230 V 50 Hz  
Batterie interne rechargeable (Autonomie 15 jours)  
Afficheur orientable et rabattable  
Corp en aluminium moulé  
Pieds réglables  
Indicateur de niveau, de planité  
Avertisseur acoustique de surcharge  
Clavier intuitif d'utilisation facile  
Fonctions de calculatrice  
Accumulation de sommes  
Unités de mesure: (Kgs., Oz, Livres)  
Fonction de tare  
Mode d'emploi en 7 langues

Rostfrei Auflagefläche 53x44 cm  
Anschlusskable 230 V 50 Hz  
Integrierte aufladbare (Leistungsdauer 15 Tage)  
Ausrichtbarer, abnehmbarer Kopfteil  
Geräterumpf aus Aluminiumguss  
Regulierbare Stützfläche  
Nivellierung-, Planheitsanzeige  
Akustischer Warnton bei Überlastung  
Berührungsempfindliche, einfach anzuwendende Tastatur  
Rechenfunktionen  
Kumulierung mehrerer Beträge  
Gewichteinheiten: (Kgrs., Oz, Pfund)  
Tara- funktion  
Handbuch in 7 Sprachen

St. Steel platform, 53x44 cm  
230 V 50 Hz connection cable  
Rechargeable internal battery (Last 15 days)  
Retractable, swivelling head  
Cast aluminium case  
Adjustable support feet  
Level and flatness indicator  
Overload alarm  
Intelligent and easy-to-use keyboard  
Calculator functions  
Total counter  
Measurement units: (Kgrs, Oz, pounds)  
Tare function  
Instructions book in 7 languages

Plataforma inoxidável 53x44 cm  
230 V 50 Hz cabo de ligação  
Bateria interna recarregável (Autonomia 15 dias)  
Cabeça orientável e abatível  
Corpo alumínio fundido  
Patas de apoio reguláveis  
Vidior de nível, planitude  
Avisador acústico de sobrecarga  
Teclado intuitivo e de fácil uso  
Função de calculadora  
cumulação de portes  
Unidades de medida (Kgrs, Oz, pounds)  
Função de tara  
Livro de instruções em 7 idiomas

Ref	Tensión/Voltage	Tara/Tare	Dimensiones/Sizes	Peso/Weight
61700	220-240 V / 50-60 Hz	150 Kgr (20 g)	49x75x90 cm	45 Kg

CERTIF.: 89/336/ECC, 91/263/EEC, 92/31/ECC, 93/68/EEC en 50 082 - 1:1992



### Báscula electrónica con base cuadrada

Balance de cuisine électronique  
Elektronische Küchenwaage mit rechteckigem Oberteil  
Electronic scale w/square base  
Balança electrónica com base quadrada

Ref	€	Tara
61716	385,70	15kg/5g
61730	415,10	30kg/10g

**Plataforma inoxidable 30x24 cm (12"x9 1/2")**  
**Cable conexión 230V 50 Hz**  
**Batería interna recargable (Autonomía 15 días)**  
**Doble display**  
**Plataforma extraíble, fácil limpieza**  
**Patas de apoyo regulables**  
**Visor de nivel, planitud**  
**Avisador acústico de sobrecarga**  
**Teclado intuitivo y de fácil uso**  
**Funciones cambio**  
**Seis memorias programable**  
**Unidades de medida (Kgs., Oz., Libras)**  
**Función de tara**  
**Libro de instrucciones en 7 idiomas**

Plateau Inoxydable 30x24 cms. (12"x9 1/2")  
Câble connexion 230 V 50 Hz  
Batterie interne rechargeable (Autonomie 15 jours)  
Double display  
Plateau amovible, nettoyage facile  
Pieds réglables  
Indicateur de niveau, de planité  
Avertisseur acoustique de surcharge  
Clavier intuitif d'utilisation facile  
Fonctions changement  
Six mémoire programmable  
Unités de mesure: (Kgs., Oz, Livres)  
Fonction de tare  
Mode d'emploi en 7 langues

Rostfrei Auflagefläche 30x24 cms. (12"x9 1/2")  
Anschlusskable 230 V 50 Hz  
Integrierte aufladbare (Leistungsdauer 15 Tage)  
Doppeltes Display  
Abnehmbare Stützfläche einfache Reinigung  
Regulierbare Stützfläche  
Nivellierung-, Planheitsanzeige  
Akustischer Warnton bei Überlastung  
Berührungsempfindliche, einfach anzuwendende Tastatur  
Tauschfunktionen  
Sechs programmierbare Speicher  
Gewichteinheiten: (Kgrs., Oz, Pfund)  
Tara- funktion  
Handbuch in 7 Sprachen

St. Steel platform, 30x24 cms. (12"x9 1/2")  
230 V 50 Hz connection cable  
Rechargeable internal battery (Last 15 days)  
Double display  
Removable, easy-to-clean platform  
Adjustable support feet  
Level and flatness indicator  
Overload alarm  
Intelligent and easy-to-use keyboard  
Change functions  
Seis memória programável  
Measurement units: (Kgrs, Oz, pounds)  
Tare function  
Instructions book in 7 languages

Plataforma inoxidável 30x24 cms. (12"x9 1/2")  
230 V 50 Hz cabo de ligação  
Bateria interna recarregável (Autonomia 15 dias)  
Duplo avanço  
Plataforma extraível, fácil limpeza  
Patas de apoio reguláveis  
Vidior de nível, planitude  
Avisador acústico de sobrecarga  
Teclado intuitivo e de fácil uso  
Função de mudança  
Seis memória programável  
Unidades de medida (Kgrs, Oz, pounds)  
Função de tara  
Livro de instruções em 7 idiomas

Ref	Tensión/Voltage	Potencia/Power	Tara/Tare	Dimensiones/Sizes	Peso/Weight
61716	220-240 V / 50-60 Hz	0,2 W (max)	15 Kgr (5 g)	30x32x12 cm	4,60 Kg
61730	220-240 V / 50-60 Hz	0,2 W (max)	30 Kgr (10 g)	30x32x12 cm	4,60 Kg

CERTIF.: OIML R76 Clase III, 60/384/ECC

## Placas de inducción

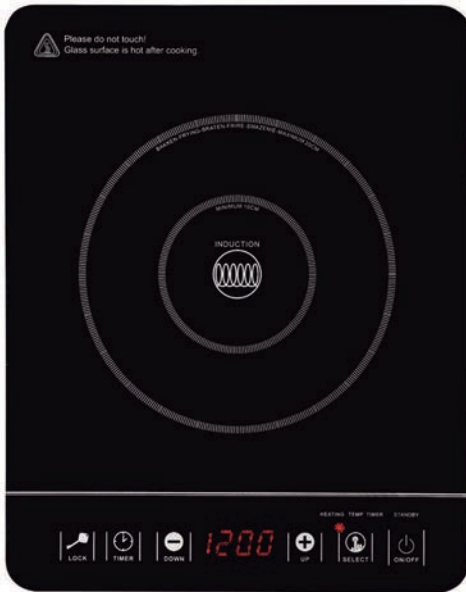

**Placas de inducción rápidas, eficaces, seguras, fiables y de gran capacidad de calentamiento**  
**Sus diseño portátiles y compactos resultan ideales para su uso en cualquier lugar**  
**Botones táctiles, intuitivos y fáciles de utilizar con un toque suave**  
**40% ahorro de tiempo y energía respecto a otras placas convencionales**

Plaque à induction rapide, efficace, sûre, fiable et d'une grande capacité de chauffe  
 Sa conception portable et compacte est idéale pour une utilisation n'importe où  
 Boutons tactiles, intuitifs et faciles à utiliser avec un toucher doux  
 40% de gain de temps et d'économies d'énergies par rapport à d'autres plaques conventionnelles

Schnelles, sicheres, zuverlässiges Induktionskochfeld mit hervorragender Heizleistung  
 Aufgrund seines tragbaren und kompakten Designs ist es überall einsetzbar  
 Intuitive, bedienerfreundliche Soft-Touch-Tastfelder  
 40 % Zeit- und Energieersparnis verglichen mit anderen herkömmlichen Kochfeldern

Fast, efficient, safe, reliable induction hob with high heating capacity  
 Its portable and compact design is ideal for use anywhere  
 Intuitive and easy to use soft touch buttons  
 40% saving in time and energy compared to other conventional hobs

Placa de indução rápida, eficaz, segura, fiável e de grande potência  
 O seu design portátil e compacto permite a sua utilização em qualquer lugar  
 Botões tácteis, intuitivos e fáceis de utilizar, com um suave toque  
 Poupança de 40% em tempo e energia, em comparação com as placas convencionais

· Professional use ·



### Placa Inducción Wok Profesional

Plaque à induction wok Professionnelle  
 Induktionskochplatte Wok Professional  
 Induction cooktop wok Professional  
 Placa indução wok Profissional

### Wok semi-esférico Trimetal

Wok hemispherique Trimetal  
 Wok, Schneeschlagkessel, Trimetal  
 Trimetal semi-spherical wok  
 Wok semi-esférica Trimetal

Ref	€	Pack
69138	365,90	1

Ref	€	Ø (cm)	L
53836	142,40	36	5,50

Ref	Tensión/Voltage	Potencia/Power	Temperatura/Temp	Tiempo/Timer	Dimensiones/Sizes	Peso/Weight
69138	220-240 V / 50-60 Hz	3500 W	60°C - 240°C	0 - 180 min	34x44,5x12,5 cm	7,50 Kg

• Professional use •

Ø12 cm Ø28 cm



**Placa Inducción Profesional**  
 Plaque Induction Professionnelle  
 Profi-Induktionsplatte  
 Professional induction cooktop  
 Placa de indução Profissional

Ref	€	Pack
69132	347,20	1

Ø12 cm Ø22 cm



**Placa Inducción Profesional**  
 Plaque Induction Professionnelle  
 Profi-Induktionsplatte  
 Professional induction cooktop  
 Placa de indução Profissional

Ref	€	Pack
69337	295,00	1

**New**

Ref	Tensión/Voltage	Potencia/Power	Niveles Pot. /P. levels	Reloj/Timer	Dimensiones/Sizes	Peso/Weight
69132	220-240 V / 50-60 Hz	3500 W	13	0 - 180 min	34x43x12 cm	7,35 Kg
69337	220-240 V / 50-60 Hz	2700 W	10	0 - 180 min	30x37x10 cm	5,40 Kg

• Household use •

Ø22 cm max



**Placa de Inducción**  
 Table de cuisine à induction  
 Induktionskochgerät  
 Induction Cooker  
 Placa de indução

Ref	€	Pack
69032	228,00	1

Ø10 cm Ø20 cm



**Placa de Inducción SLIM**  
 Table de cuisine à Induktion  
 Induktionskochgerät  
 Induction cooker  
 Placa de indução

Ref	€	Pack
69332	128,00	1

**New**

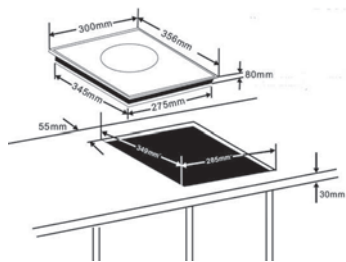

**Posibilidad de encastrar**  
 Encastrable option

Ref	Tensión/Voltage	Potencia/Power	Niveles Pot. /P. levels	Reloj/Timer	Dimensiones/Sizes	Peso/Weight
69032	220-240 V / 50-60 Hz	2000 W	6	0 - 180 min	35x30x6,5 cm	2,90 Kg
69332	220-240 V / 50-60 Hz	2000 W	8	0 - 180 min	30x37x10 cm	3,40 Kg

• Household use •

**New**

Ø16-20  
cm



Ø10  
cm

Ø20  
cm



**Placa Inducción doble**  
Plaque Induction double  
Elektromixer mit Gefäß  
Double induction cooktop  
Placa de indução dupla

Ref	€	Pack
69033	369,70	1

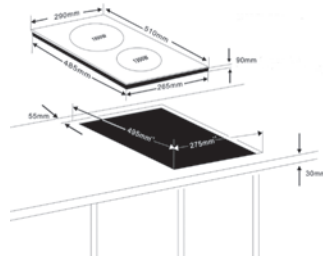

Posibilidad de encastrar  
Encastrable option

**Placa Inducción DUAL**  
Plaque Induction  
Elektromixer mit Gefäß  
Induction cooktop  
Placa de indução

Ref	€	Pack
69333	218,50	1

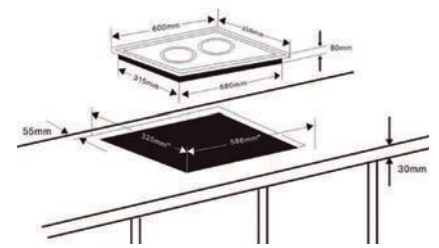

Posibilidad de encastrar  
Encastrable option

Ref	Tensión/Voltage	Potencia/Power	Niveles Pot. /P. levels	Reloj/Timer	Dimensiones/Sizes	Peso/Weight
69033	220-240 V / 50-60 Hz	1800 -1300 W	8	0 - 99 min	29x51x9 cm	4,50 Kg
69333	220-240 V / 50-60 Hz	2000 W + 1500 W	7	0 - 180 min	60x34x7,5 cm	5,20 Kg



## Placas Grill

**New**

· Professional use ·

**Placa Grill Profesional**

Plaque Professionnel  
Profi-Grill  
Professional grill plate  
Grelhador Profissional

Ref	€	Pack
69179	640,50	1

**Fabricada en acero inoxidable. Protector anti-salpicaduras**  
**Placa con superficie lisa de acero laminado y rectificado, calentamiento uniforme**  
**Control de temperatura por termostato hasta 300°C**  
**Depósito recoge grasas**  
**Especialmente indicada para bares, restaurantes, hoteles, etc.**  
**Ideal para cocinar a la plancha carnes, pescados, verduras, hortalizas, crêpes, huevos...**

Fabriquée en acier inoxydable. Protection contre anti-éclaboussures  
Plaque avec surface lisse en acier laminé et rectifié, chauffe uniforme  
Contrôle de température par thermostat jusqu'à 300°C  
Réservoir ramasse-graisses  
Spécialement indiquée pour les bars, restaurants, hôtels, etc.  
Pour faire à la plancha des viandes, poissons, légumes, crêpes, œufs ...

Aus rostfreiem Stahl hergestellt. Anti-Spritzschutz  
Ebene Grillplatte aus laminiertem, plangeschliffenem Edelstahl, gleichmäßige Erwärmung  
Temperaturregelung mit Thermostat bis 300 °C  
Fettauffangbehälter.  
Besonders für Gaststätten, Restaurants, Hotels, usw. geeignet  
Zum Grillen von Fleisch, Fleisch, Gemüse, Crêpes, Eier usw.

Made in stainless steel. Anti-splash guard  
Laminated steel, flat surface griddle with uniform heating  
Thermostat temperature control up to 300°C  
Oil collector  
Especially made for bars, restaurants, hotels, etc.  
To cook meat, fish, vegetables, crepes and eggs on the griddle...

Fabricada em aço inoxidável. Inclui protetor anti-salpicaduras  
Placa com superfície lisa de aço laminado e retificado, de aquecimento uniforme  
Controlo de temperatura por termostato até 300 °C  
Depósito para recolha de gorduras  
Especialmente indicada para bares, restaurantes, hotéis, etc.  
Para grelhar carnes, peixes, verduras, hortaliças, crepes, ovos, etc.

Ref	Tensión/Voltage	Potencia/Power	Temperat./Temp.	Zona trabajo/Working zone	Superf. placa/Grill surface	Dimensiones/Sizes	Peso/Weight
69179	220-240 V / 50-60 Hz	6 Kw	300°C	2	61x40 cm	61,5x51x26 cm	37 Kg

· Professional use ·

**Estructura de acero inoxidable**

**Ideal para calentar, asar, tostar o gratinar directamente los alimentos**  
**Placa de calentamiento y techo móvil, ajustando la posición deseada**

Structure en acier inoxydable  
Idéale pour chauffer, rôtir, griller ou gratiner directement les aliments  
Plaque de chauffe et toit mobile avec réglage de la position souhaitée

Struktur aus rostfreiem Stahl  
Ideal zum direkten Aufwärmen, Braten, Rösten oder Gratinieren von Lebensmitteln  
Bewegliche Heizplatte und Abdeckung zum Einstellen der gewünschten Position

Stainless steel structure  
Ideal for directly heating, roasting, toasting or browning food  
Movable heating plate and roof, adjusting the desired position

Estrutura de aço inoxidável  
Ideal para aquecer, assar, tostar ou gratinar diretamente os alimentos  
Placa de aquecimento e cobertura móvel, ajustável à posição desejada

**Salamandra eléctrica Profesional**

Salamandre électrique Professionnelle  
Professioneller elektrogrill  
Professional salamander electric grill  
Salamandra eléctrica Profissional

Ref	€	Pack
69197	950,10	1

Ref	Tensión/Voltage	Potencia/Power	Temperatura/Temp.	Plancha/Grill	Dimensiones/Sizes	Peso/Weight
69197	220-240 V / 50-60 Hz	4000 W	50°C - 300°C	59x32 cm	60x45x50 cm	49 Kg

· Semiprofessional use ·



**Plancha Grill**  
Grill électrique  
Elektro-grill  
Electric grill  
Grelhar eléctrico

**Estructura de acero inoxidable**  
**Ideal para preparar carnes, pescados, verduras, bocadillos, etc.**  
**Doble placa ondulada. Placa superior regulable en altura**  
**Bandeja recoge grasas y mango aislante térmico**

Structure en acier inoxydable  
Idéale pour préparer des viandes, poissons, légumes, sandwichs, etc.  
Double plaque ondulée. Plaque supérieure réglable en hauteur  
Plateau ramasse-miettes et manche isolant thermique

Struktur aus rostfreiem Stahl  
Ideal zum Zubereiten von Fleisch, Fisch, Gemüse, Snacks, etc.  
Gewellte Doppelplatte Obere Platte höhenverstellbar  
Fettauffangtablett und wärmeisolierter Griff

Stainless steel structure  
Ideal for preparing meats, fish, vegetables, sandwiches, etc.  
Double ribbed plate. Height adjustable top plate  
Grease tray and thermal insulation handle

Estrutura em aço inoxidável  
Ideal para preparar carnes, peixes, verduras, sanduíches, etc.  
Dupla placa ondulada. Placa superior regulável em altura  
Bandeja recolhedor de gorduras e mango isolante térmico

Ref	€	Pack
69166	373,40	1 SIMPLE
69167	582,80	1 DOBLE · DOUBLE

Ref	Tensión/Voltage	Tensión/Voltage	Potencia/Power	Temp./Temp.	Temp./Temp.	Dimensiones/Sizes	Peso/Weight
69166	SIMPLE	220-240 V / 50-60 Hz	2,20 Kw	300°C / 572°F (max)	50°C / 122°F (min)	31x31x20 cm	25 Kg
69167	DOBLE · DOUBLE	220-240 V / 50-60 Hz	4,40 Kw	300°C / 572°F (max)	50°C / 122°F (min)	57x31x20 cm	35 Kg

· Semiprofessional use ·



**Placa Grill eléctrica**  
Grill Electrique  
Elektro-Grill  
Electric Grill  
Grelhador Eléctrica



220°C  
max.

**Totalmente abatible, para un máximo aprovechamiento y regulación en altura de la placa superior**  
**Contenedor recoge grasas**  
**Fácil extracción y colocación de las bandejas para su limpieza**

Totalement rabattable, pour une utilisation maximale et un réglage en hauteur de la plaque supérieure  
Conteneur ramasse graisses  
Facile extraction et installation des plateaux pour leur nettoyage

Komplett kippbar für eine maximale Ausnutzung und Regulierung der Höhe der oberen Platte  
Fettauffangbehälter  
Leichter Aus- und Einbau der Bleche zu Reinigungszwecken

Fully collapsible, for maximum use and regulation on the upper plate  
Fat-collection container  
Easy removal and placement of the trays for cleaning

Totalmente abatível, para maior aproveitamento e regulação em altura da placa superior  
Recipiente recolhedor de gorduras  
Fácil extração e colocação das bandejas para a sua limpeza

Ref	€	Pack
69174	190,60	1

Ref	Tensión/Voltage	Potencia/Power	Temperatura/Temp.	Parrilla/Grill	Dimensiones/Sizes	Peso/Weight
69174	220-240 V / 50-60 Hz	1400 W	200°C (max)	30x26 cm	43x35x19 cm	7,20 Kg

• Household use •



**Protector de salpicaduras y bandeja recoge grasas apta para el lavavajillas**  
 Protection anti-éclaboussures et plateau ramasse-graisses allant au lave-vaisselle  
 Spritzschutz und waschmaschinenfeste Fettauffangwanne  
 Splash protector and dishwasher safe fat-collection tray  
 Protetor de salpicaduras e bandeja recolhedora de gorduras, apta para a máquina de lavar louça

220°C  
max.

**Placas de aluminio fundido antiadherente de gran calidad, libre de PFOA**  
**Doble zona de cocción para cocinar todo tipo de alimentos:**  
 \* Grill: Ideal para asar carnes, pescados, marisco, hamburguesas o verduras  
 \* Lisa: Ideal para preparar tortitas, huevos, tostadas o verduras  
**Alcanzan rápidamente la temperatura indicada**  
**Garantizan una cocción uniforme por toda la superficie**  
**Regulador de temperatura desmontable (69227), mucho más fácil de limpiar**  
**La ranura central hace que la grasa se deposite en la bandeja recoge-grasas**  
**Las asas con recubrimiento aislante de calor proporcionan seguridad**

Plaque en fonte d'aluminium antiadhésive de grande qualité, sans PFOA.  
 Double espace de cuisson pour cuisiner tout type d'aliment :  
 \* Grill : Idéal pour griller des viandes, des poissons, des fruits de mer, des hamburgers ou des légumes  
 \* Lisse : Idéal pour préparer des petites galettes, des oeufs, des toasts ou des légumes  
 Atteint rapidement la température indiquée  
 Garantit une cuisson uniforme sur toute la surface  
 Régulateur de température démontable (69227), beaucoup plus facile à nettoyer  
 La rainure centrale permet à la graisse de se déposer sur le plateau recueille-graisses  
 Les poignées dotées d'un revêtement isolant de la chaleur apportent de la sécurité



Qualitativ hohe Grillplatte aus Aluminiumguß mit Haftbeschichtung, frei von PFOA  
 Doppelkochbereich für die Zubereitung jede Art von Mahlzeiten:  
 \* Grillgitter: Ideal zum Grillen von Fleisch, Fisch, Meeresfrüchten, Burger oder Gemüse  
 \* Grillplatte: Ideal für die Herstellung von Pfannkuchen, Eiern, Toast oder Gemüse  
 Erreicht schnell die angegebene Temperatur  
 Sorgt für gleichmäßiges Garen auf der gesamten Oberfläche  
 Abnehmbarer Temperaturregler, leichter zu reinigen  
 Die zentrale Rinne bewirkt (69227), dass Fett in der Fettauffangwanne abgeschieden wird  
 Griffe mit wärmedämmender Beschichtung sorgen für Sicherheit

**Placa grill doble eléctrica**

Grill électrique doubler  
 Doppel Elektro-Grill  
 Double electrical grill  
 Grelhador eléctrico duplo

Ref	€	Pack
69200	152,10	1

High-quality, non-stick, PFOA-free cast aluminium plate  
 Dual cooking area for cooking all kinds of food:  
 \* Grill: Ideal for grilling meat, fish, seafood, hamburgers or vegetables  
 \* Smooth: Ideal for making pancakes, eggs, toast or vegetables  
 Quickly reaches the specified temperature  
 Ensures even cooking across the entire surface  
 Detachable temperature controller is much easier to clean (69227)  
 Fat runs down the central groove and is gathered in the grease tray  
 Handles with heat-insulating coating for added safety

• Household use •

**New**

230°C  
max.

**Placa de alumínio fundido antiaderente de grande qualidade, sem PFOA**  
**Dupla zona de cocção para cozinhar todo o tipo de alimentos:**  
 \* Grill: Ideal para assar carnes, pescados, mariscos, hambúrgueres e verduras  
 \* Lisa: Ideal para preparar tortitas, ovos, tostas ou verduras  
**Alcança rapidamente a temperatura indicada**  
**Garante uma cocção uniforme em toda a superfície**  
**Regulador de temperatura desmontável (69227), mais fácil de limpar**  
**A ranhura central permite que a gordura se deposite na bandeja recoleitora**  
**As asas com revestimento isolante do calor proporcionam maior segurança**



**Regulador de temperaturadesmontable**  
 Régulateur de température démontable  
 Abnehmbarer Temperaturregler  
 Detachable temperature controller  
 Regulador de temperaturadesmontável

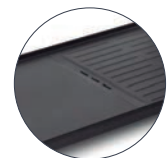

**Doble zona de cocción**  
 Double espace de cuisson  
 Zwei Garbereiche  
 Dual cooking area  
 Dupla zona de cocção

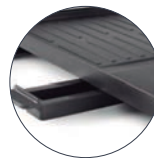

**Bandeja recoge grasas**  
 Plateau recueille-graisses  
 Fettauffangwanne  
 Grease tray  
 Bandeja para recolher as gorduras

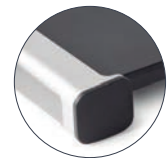

**Asas aislantes de calor**  
 Poignées isolantes de la chaleur  
 Wärmeisolierte Griffe  
 Heat-insulating handles  
 Asas isolantes do calor

**Plancha & Grill**

Plancha & Grill  
 grillplatte  
 Grill plate  
 Prancha & Grelhador

Ref	€	Pack
69227	67,50	1

Ref	Tensión/Voltage	Potencia/Power	Temperatura/Temp.	Parilla/Grill	Dimensiones/Sizes	Peso/Weight
69200	220-240 V / 50-60 Hz	2000 W	0 - 220°C	50x31,5 cm	53x36x17 cm	5,30 Kg
69227	220-240 V / 50-60 Hz	1800 W	0 - 230°C	52x30 cm	61x32,5x6 cm	3,20 Kg

• Household use •



**Plancha grill TEPPANYAKI**

Grill Electrique TEPPANYAKI  
Elektro-Grill, TEPPANYAKI  
TEPPANYAKI Electric Grill  
Grelhador Eléctrica TEPPANYAKI

Ref	€	Pack
69133	301,20	3

**Calentamiento por infrarrojos y rápido**  
**Dos zonas independientes de cocción y zona de calentamiento**  
**Permite el uso de útiles de cocina metálicos**  
**Ranura recoge grasas**  
**Mejora el rendimiento eléctrico 15% en comparación con otros grilles de aluminio fundido**

Chauffe par infrarouges et rapide  
Deux zones indépendantes de cuisson et zone de chauffe  
Permet l'utilisation d'accessoires de cuisine métalliques  
Rainure ramasse-graisses  
Améliore le rendement électrique de 15% par rapport à d'autres grilles en fonte d'aluminium

Schnelle Infrarot-Erwärmung  
Zwei unabhängige Kochfelder und Erwärmungsfeld  
Es kann Kochgeschirr aus Metall verwendet werden  
Fettauffangrinne  
Verbesserte die elektrische Leistung um 15% im Vergleich zu anderen Grills aus Aluminiumguß

Fast infrared heating system  
Two independent cooking areas and heating area  
Allows the use of metal kitchen utensils.  
Fat-collection groove  
Improves energy performance by 15% in comparison with other cast aluminium grills

Aquecimento por infravermelhos e rápido  
Duas zonas independentes de cocção e zona de aquecimento  
Permite o uso de utensílios de cozinha metálicos  
Ranhura recolhe-migas  
Melhora o rendimento elétrico em 15%, em comparação com outros grelhadores de alumínio fundido

Ref	Tensión/Voltage	Potencia/Power	Temperatura/Temp.	Parrilla/Grill	Dimensiones/Sizes	Peso/Weight
69133	220-240 V / 50-60 Hz	1280 W	300°C (max)	43x27 cm	60x34x8 cm	5,50 Kg



## Placas Creperas · Gofrera

*Disfruta de Crepes recién hechos*

*Savourez des crêpes fraîchement élaborées · Genießen Sie frisch zubereitete Crêpes  
Enjoy freshly-made crêpes · Desfruta de crepes recién-acabados*



**Crea crepes dulces y salados, pancakes y tortitas de una manera sencilla y cómoda**

**Rapidez, potencia y un calentamiento uniforme**

**Placa de aluminio antiadherente de Ø30 cm, perfecta para hacer crepes de gran tamaño**

**Incluye rastrillo de madera para extender la masa y conseguir un grosor homogéneo y espátula para voltear el crepe**

Faites des crêpes sucrées et salées, des pancakes et des petites galettes de façon simple et pratique

Rapidité, puissance et une chauffe uniforme

Plaque en aluminium antiadhésive de Ø30 cm, parfaite pour faire de grandes crêpes

Inclut râtelier en bois pour étaler la pâte et obtenir une épaisseur homogène, et une spatule pour retourner la crêpe

Süße und salzige Crêpes, Pancakes und Buletten auf einfache und bequeme Weise zubereiten

Schnelligkeit und Leistung bei gleichmäßiger Wärmeverteilung

Anti-Haftbeschichtung aus Aluminium mit Ø30 cm, perfekt für große Crêpes

Inklusive Holzspachtel, um den Teig zu verteilen und eine gleichmäßige Dicke zu erzielen, und Kelle, um die Crêpes zu wenden

Make sweet and savoury crêpes, pancakes and pikelets easily and conveniently

Speed, power and uniform heating

Non-stick aluminium plate Ø30 cm, perfect for making large crêpes

Includes a wooden scraper for spreading the batter to achieve uniform thickness and a spatula to flip the crêpe

Para fazer crepes doces e salgados, panquecas e tortitas de maneira fácil e cómoda

Rapidez, potência e aquecimento uniforme

Placa de alumínio antiaderente de Ø30 cm, ideal para fazer crepes de tamanho grande

Inclui utensílio de madeira para estender a massa e conseguir uma espessura homogênea, e uma espátula para virar os crepes

· Professional use ·



### Placa crepera Eléctrica

Plaque crêpière électrique  
Crêpes-Kochplatte Elektrische  
Electric crepe maker  
Placa crepeira eléctrica

Ref	€	Pack
69196	380,30	1

Ref	Tensión/Voltage	Potencia/Power	Temperatura/Temp.	Ø Plancha/Grill	Dimensiones/Sizes	Peso/Weight
69196	220-240 V / 50-60 Hz	3000 W	50°C - 250°C	35 cm	45x49x22,5 cm	23 Kg

• Semiprofessional use •



**Crepera eléctrica BLACK**

Crêpière Electrique  
Crêpesplatte Elektrisch  
Electric crepe maker  
Crepeira Eléctrica

**Crepera eléctrica WHITE**

Crêpière Electrique  
Crêpesplatte Elektrisch  
Electric crepe maker  
Crepeira Eléctrica

Ref	€	Pack
69122	42,80	4

Ref	€	Pack
69222	59,70	4

Ref	Tensión/Voltage	Potencia/Power	Temperatura/Temp.	Placa/Grill	Dimensiones/Sizes	Peso/Weight
69122	220-240 V / 50-60 Hz	1000 W	200°C (max)	Ø30 cm	40x36x11 cm	2,12 Kg
69222	220-240 V / 50-60 Hz	1000 W	240 °C (max)	Ø30 cm	40x39x8 cm	1,72 Kg

• Professional use •



Hierro colado  
Cast iron



**New**

**Gofrera Eléctrica**

Gaufrier électrique  
Elektrische wendewaffeleisen  
Electric waffle maker  
Maquina de fazer goffres eléctrica

**Fabricada en acero inoxidable de la máxima calidad  
Placas de calentamiento con recubrimiento antiadherente  
Rápida de calentar, alcanza fácilmente la temperatura máxima de 300°C  
Obtendrás gofres crujientes de forma sencilla y rápida**

Fabriqué en acier inoxydable de la plus grande qualité  
Plaques de chauffe avec revêtement anti-adhésif  
Rapide à chauffer, il atteint facilement la température maximale de 300°C  
Vous obtiendrez des gaufres croustillantes de façon simple et rapide

Aus hochwertigem, rostfreiem Stahl hergestellt  
Heizplatten mit Antihafbeschichtung  
Schnelle Erhitzung, erreicht schnell die maximale Temperatur von 300 °C  
Zur schnellen und einfachen Zubereitung von knusprigen Waffeln

Made in top quality stainless steel  
Heating griddle with non-stick coating  
Fast heating, easily reaching maximum temperatures of 300°C.  
Make crunchy waffles easily and quickly

Fabricada em aço inoxidável da melhor qualidade  
Placas de aquecimento com revestimento antiaderente  
Aquece rapidamente, alcançando facilmente a temperatura máxima de 300 °C  
Para conseguir gofres estaladiços de forma simples e rápida

Ref	€	Pack
69349	245,20	1

Ref	Tensión/Voltage	Potencia/Power	Temperat./Temp.	Tiempo/Timer	Placa Gofre/Waffle plate	Dimensiones/Sizes	Peso/Weight
69349	220-240 V / 50-60 Hz	1000 W	50°C - 300°C	5 min	Ø18 cm	26x44x266 cm	7 Kg

• Semiprofessional use •

**Permite fundir chocolate y mantenerlo caliente**  
**Preparará fácilmente coberturas para sus postres**  
**Puede añadirle especias (canela, jengibre en polvo, pimentas, vainilla) para un chocolate más intenso**

Permet de faire fondre le chocolat et de le maintenir chaud  
 Préparation facile de glaçages pour les desserts  
 Possibilité d'ajouter des épices (cannelle, gingembre en poudre, poivre, vanille) pour un chocolat plus intense

Ermöglicht das Schmelzen und Warmhalten von Schokolade  
 Damit können Sie ganz einfach eine Kuvertüre für Ihre Desserts erstellen  
 Sie können Gewürze hinzufügen (Zimt, Ingwer-Pulver, Pfeffer, Vanille) für eine intensivere Schokolade

It allows you to melt chocolate and keep it hot  
 Easily prepare toppings for your desserts  
 You can add spices (cinnamon, ginger powder, peppers, vanilla) for a more intense chocolate

Para fundir chocolate, mantendo-o quente  
 Para preparar facilmente as coberturas para as suas sobremesas  
 Permite adicionar especiarias (canela, gengibre em pó, pimentas, baunilha) para obter um chocolate mais intenso



**Baño María chocolate**

Bain Marie de chocolat  
 Bain Marie topf für Schokolade  
 Chocolate Bain Marie  
 Banho-Maria Chocolate

Ref	€	Pack
69317	33,20	1

Ref	Tensión/Voltage	Potencia/Power	Temperatura/Temp.	Capacidad/Capacity	Dimensiones/Sizes	Peso/Weight
69317	220-240 V / 50-60 Hz	70 W	40 -50°C	1,0 L (max.)	29x22x12 cm	875 g

• Household use •



**Fuente de chocolate**

Fontaine chocolat  
 Schokoladen Fontäne  
 Chocolate fountain  
 Fonte chocolate

	Ref	€	Tower	Pack
<b>A</b>	69318	49,20	18 cm	1
<b>B</b>	69319	81,40	38 cm	1

Ref	Tensión/Voltage	Potencia/Power	Temperatura/Temp.	Capacidad/Capacity	Torre/Tower	Dimensiones/Sizes	Peso/Weight
69318	220-240 V / 50-60 Hz	35 W	40 -50°C	0,50 L (max)	18 cms (Height)	Ø16x30 cm	1,15 Kg
69319	220-240 V / 50-60 Hz	80 W	40 -50°C	1,80 L (max)	38 cms (Height)	Ø23x54,5 cm	2,05 Kg

## Placas calentamiento

· Professional use ·



### Placa calentamiento Eléctrica Inox

Plaque électrique pour Chauffante  
Warmhalteplatte  
Electrical warming Plate  
Placa aquecimento eléctrica Inóx

Ref	€	Pack
69045	83,90	1

*Platos y bandejas siempre calientes*  
Ensures dishes and trays are always warm

Una solución perfecta para profesionales de hostelería, buffet, eventos, catering, ferias...

Idéal para mantener tanto platos como bandejas de alimentos calientes antes de servirlos en la mesa a una temperatura perfecta

Termostato regulable en temperatura  
Prohibido cocinar sobre la misma placa

Une solution parfaite pour les professionnels de l'hôtellerie, buffets, événements, traiteurs, salons, ...

Idéale pour garder au chaud aussi bien les assiettes que les plats d'aliments avant de les servir à table à une température parfaite

Thermostat réglable en température  
Il est strictement interdit de cuisiner sur la plaque

Die perfekte Lösung für Gastgewerbe, Büffets, Veranstaltungen, Catering, Messen ...

Idéal, um gefüllte Teller und Tablettis vor dem Servieren am Tisch bei perfekter Temperatur zu halten

Thermostat mit Temperaturregelung  
Kochen auf der Platte ist nicht gestattet

A perfect solution for hospitality, buffet, events, catering and trade show professionals...

Idéal for keeping both dishes and trays of food warm before serving them at a perfect temperature

Temperature-adjustable thermostat  
Do not cook on the hot plate

Uma solução perfeita para profissionais da hotelaria, buffets, eventos, catering, feiras...

Idéal para manter quentes pratos e bandejas de alimentos, para os servir à mesa a uma temperatura perfeita

Termostato de temperatura regulável  
Nunca cozinhar sobre a própria placa!

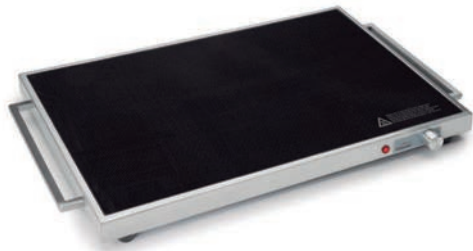

### Placa calentamiento Eléctrica Vitrocerámica

Plaque vitrocéramique chaleur  
Glaskeramikheizplatte  
Hob heating plate  
Placa aquecimento eléctrica vitrocerámica

Ref	€	Pack
69145	165,60	1

Ref	Tensión/Voltage	Potencia/Power	Rango temp./Temp.	Temp. máx./Max. temp.	Dimensiones/Sizes	Peso/Weight
69045	220-240 V / 50-60 Hz	300 W	0° - 80° C	80° C	53x35,5 cm	3,50 Kg
69145	220-240 V / 50-60 Hz	230 W	60° - 105°C (+/-5°C)	105° C	55x35x5 cm	4,40 Kg

## Placa calentamiento Chafing Dish

· Professional use ·

**A** 96°C Max.



**B** 92°C Max.



### Calentador eléctrico para Chafing

Corp de chauffe pour bain marie  
Elektro-Heizung  
Electric heating unit for chafing dish  
Aquecedor eléctrico para chafing dish

Ref	€	Pack
<b>A</b> 69002	150,90	1
<b>B</b> 69012	174,50	1

Ref	Tensión/Voltage	Potencia/Power	Temp./Temp.	Dimensiones/Sizes	Adapt.
69002	220-240 V / 50-60 Hz	700 W	96°C (max)	25x20 cm	69015-69000 69001-69004
69012	220-240 V / 50-60 Hz	700 W	92°C (max)	25x20 cm	69110



## Lámparas calentamiento

AL  
Aluminium

· Professional use ·

### Lámpara calentamiento infrarrojos

Lampe de chauffage infrarouge  
Infrarot Warmlampe  
Infrared heating lamp  
Lâmpara calor infravermelho



	Ref	€	Pack
<b>A</b>	69061	116,50	1
<b>B</b>	69361	84,10	1

Ref	Tensión/Voltage	Potencia/Power	Dimensiones/Sizes	Peso/Weight
69061	220-240 V / 50-60 Hz	550 W	36x45x61 - 75 cm	1,58 Kg
69361	220-240 V / 50-60 Hz	275 W	34x33x56 -71 cm	1,15 Kg

· Professional use ·

### Lámpara de calentamiento infrarrojos

Lampe de chauffage infrarouge  
Infrarot Warmlampe  
Infrared heating lamp  
Lâmpara calor infravermelho

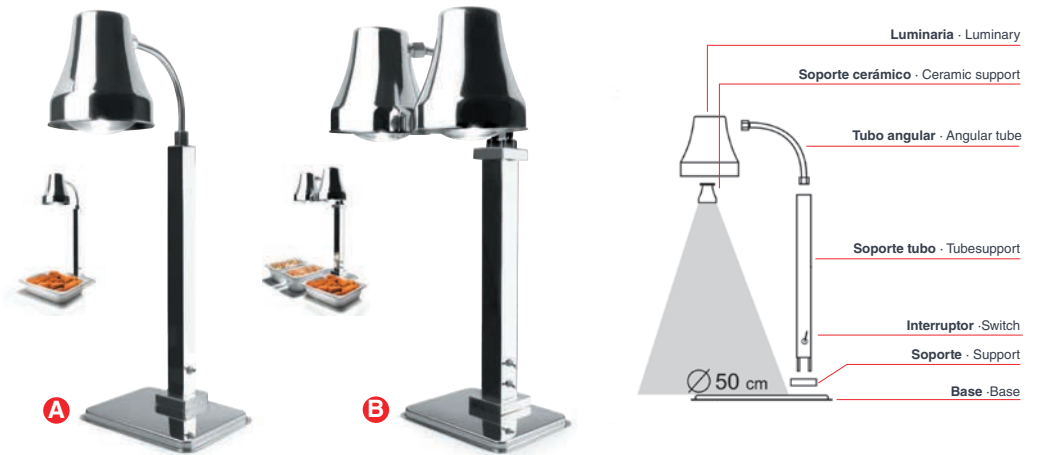

	Ref	€	Pack
<b>A</b>	69263	386,80	1
<b>B</b>	69264	502,80	1

Ref	Tensión/Voltage	Potencia/Power	Dimensiones/Sizes	Peso/Weight
69263	220-240 V / 50-60 Hz	275 W	79x31x23 cm	6,0 Kg
69264	220-240 V / 50-60 Hz	550 W	76x36x36 cm	7,0 Kg

· Professional use ·

### Lámpara de calentamiento infrarrojos cable extensible

Lampe de chauffage infrarouge câble extensible  
Infrarot Warmlampe Kabel stretchbar  
Infrared heating lamp rise and full cable  
Lâmpara calor infravermelho cabo extensível

	Ref	€	Pack	
<b>A</b>	69266	96,10	1	Lijado · Sanding
<b>B</b>	69365	110,00	1	Cromado · Chrome <b>New</b>
<b>C</b>	69267	238,90	1	Cobre · Copper <b>New</b>

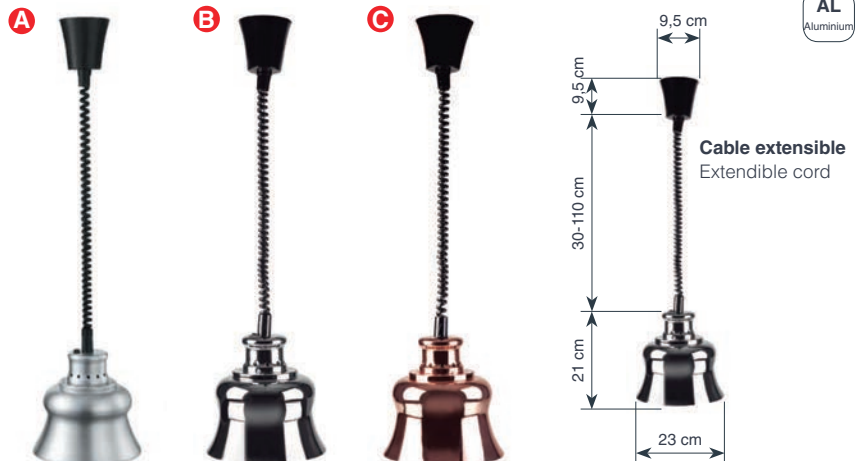

Ref	Tensión/Voltage	Potencia/Power	Dist. lámp.-alimentos Lamp-food distance	Dimensiones/Sizes	Peso/Weight
69266	220-240 V / 50-60 Hz	275 W	50-60 cm	24x24x35 cm	2,0 Kg
69365	220-240 V / 50-60 Hz	275 W	50-60 cm	24x24x35 cm	2,0 Kg
69367	220-240 V / 50-60 Hz	275 W	50-60 cm	24x24x35 cm	2,0 Kg

## Calentadores

· Professional use ·

**Calentador eléctrico de sopa**  
 Chauffe-soupe électrique  
 Elektrische Suppenbereiter  
 Electric soup heater  
 Aquecedor de sopa eléctrico

Ref	€	Pack
69267	238,90	1



**Mantiene caliente todo tipo de sopas, salsas, consomés y líquidos**  
**Ideal para cantidades grandes**

Maintenir au chaud tout type de soupes, sauces, consommés, liquides, etc...  
 Idéal pour de grandes quantités

Warmhalten aller Arten von Suppen, Saucen, Konsommees, Flüssigkeiten, usw.  
 Ideal für große Mengen

Keep all kinds of soups, sauces, consommés, liquids etc hot  
 Ideal for large amounts

Manter quente todo o tipo de sopas, molhos, consomés, líquidos, etc...  
 Ideal para grandes quantidades



**Olla calentador sopa eléctrico**  
 Electrique marmite Buffet chaud  
 Elektrischer Suppen-und Speisenwärmer  
 Electric soup kettle  
 Panela aquecedora de sopa eléctrica

Ref	€	Pack	
<b>A</b> 69037	140,00	1	Hierro esmaltado
<b>B</b> 69038	201,00	1	Inox



**Contenedor sopa Inox 10 L**  
 Bac pour soup en inox  
 Behälter für elektrischen Wärmer  
 St. Steel soup container  
 Recipiente sopa Inóx 10 L



Ref	€	Ø (cm)	L
69039	47,00	24x25	10

Ref	Tensión/Voltage	Potencia/Power	Temperatura/Temp.	Capacidad/Capacity	Dimensiones/Sizes	Peso/Weight
69267	220-240 V / 50-60 Hz	800 W	30°C - 90°C	11,0 L	Ø33x32 cm	4,50 Kg
69037	220-240 V / 50-60 Hz	400 - 475 W	30°C - 90°C	10,0 L	Ø34,5x36 cm	4,50 Kg
69038	220-240 V / 50-60 Hz	400 - 475 W	30°C - 90°C	10,0 L	Ø34,5x36 cm	4,50 Kg

· Professional use ·

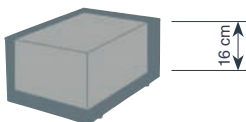

**Baño María eléctrico GN 1/1 150 mm**  
 Electrique bain-marie en inox GN 1/1 150 mm  
 Elektrische Bain Marie, GN 1/1 150 mm, Rostfrei  
 St. Steel electric bain-marie GN 1/1 150 mm  
 Banho-maria eléctrico GN 1/1 150 mm

Ref	€	Pack
69036	188,80	4

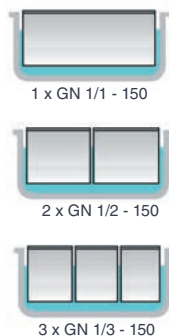

Ref	Tensión/Voltage	Potencia/Power	Temperatura/Temp.	Capacidad/Capacity	Dimensiones/Sizes	Peso/Weight
69036	230 V / 50 Hz	1300 W	75°C	24 L	61,5x39x30 cm	8,20 Kg

## Hornos

· Household use ·



## Accesorios

Accessoires · Zubehör · Accessories · Acessórios

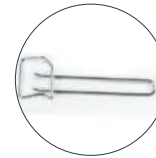
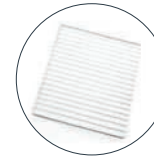
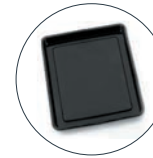
Pincho mariposa  
Butterfly skewerPinza bandeja  
Tray tongMango pincho mariposa  
Handle of butterfly skewerParrilla  
Wire rackBandeja horno  
Oven tray

## Horno - Grill

Four - Grill  
Ofen - Grill  
Oven - Grill  
Forno - Grill

Ref	€	L	Pack
69326	131,10	26	1
69342	189,80	42	1

Ref	Tensión/Voltage	Potencia/Power	Temperatura/Temp.	Capacidad/Capacity	Dim. interior/Int. size	Dimensiones/Sizes	Peso/Weight
69326	220-240 V / 50-60 Hz	1500 W	100 - 250°C	26 L	36,5x31x22 cm	51x37x30 cm	7,65 Kg
69342	220-240 V / 50-60 Hz	2000 W	100 - 250°C	42 L	40,5x33,5x28 cm	41,5x55x36 cm	10 Kg

## Microondas

· Professional use ·



## Horno microondas Profesional

Four à micro ondes Professionnel  
Prof-C ofen  
Professional microwave oven  
Microondas Professional

Ref	€	L	Pack
69325	494,10	25	1

Diseñado para uso intensivo, reduciendo el tiempo de calentamiento un 60%  
Materiales robustos y mayores medidas de seguridad. Mayor protección del usuario a radiaciones

Base de cerámica plana, sin plato de vidrio. Posibilidad de calentar platos grandes  
Cavidad interior de acero inoxidable (más higiénico). Calentamiento homogéneo

Conçu pour un usage intensif, réduisant le temps de chauffe de 60%  
Matériaux robustes et mesures de sécurité accrues. Protection plus importante de l'utilisateur vis-à-vis des radiations

Base en céramique plate, sans plateau en verre. Possibilité de chauffer de grandes assiettes  
Cavité intérieure en acier inoxydable (plus hygiénique). Chauffe homogène

Für eine intensive Benutzung ausgelegt, die Aufwärmzeit ist um 60% reduziert  
Robuste Materialien und bessere Sicherheitsmaßnahmen. Besserer Schutz vor Wärmestrahlung

Glatte Keramikboden, ohne Glatteller. Es können große Teller erwärmt werden  
Innenraum aus Edelstahl (hygienischer). Gleichmäßige Erwärmung

Designed for intensive use; reduces heating time by 60%  
Robust materials and greater safety measures. Greater protection against heat for the user  
Flat ceramic base with no glass plate. It can heat large dishes  
Inside cavity made of stainless steel (more hygienic). Even heating

Concebido para um uso intensivo, reduzindo em 60% o tempo de aquecimento  
Materiais robustos e medidas de segurança, para uma maior proteção do usuário contra as radiações  
Base cerâmica plana, sem prato de vidro. Permite aquecer pratos de grandes dimensões  
Cavidade interior em aço inoxidável (mais higiénico). Aquecimento homogéneo

Ref	Tensión/Voltage	Potencia/Power	Capacidad/Capacity	Dimensiones/Sizes	Peso/Weight
69325	220-240 V / 50 Hz	1000 W / 1550 W	25 L	51x43x31 cm	14,60 Kg

· Professional use ·



**Horno microondas con plato giratorio + Grill**

Four micro-ondes avec plateau tournant + Grill  
Mikrowelle ofen mit drehbarteller + Grille  
Microwave oven with turntable + Grill  
Microondas com prato giratório + Grill

	Ref	€	L	Pack
<b>A</b>	69323	206,80	23	1
<b>B</b>	69324	225,00	25	1
<b>C</b>	69330	268,30	30	1

Ref	Tensión/Voltage	Potencia/Power	Pot. Grill/Grill power	Capacidad/Capacity	Plato/Plateau	D. int/Int. size	Dimensiones/Sizes	Peso/Weight
69323	220-240 V / 50 Hz	800 W	1000 W	23 L	Ø27 cm	33x32x20,5 cm	51x42x28 cm	15,5 Kg
69324	220-240 V / 50 Hz	900 W	1000 W	25 L	Ø31,5 cm	35,5x33x21 cm	51x43x30 cm	14,3 Kg
69330	220-240 V / 50 Hz	900 W	1000 W	30 L	Ø31,5 cm	33,2x37,5x23,8 cm	52x49,5x32,5 cm	15,6 Kg

· Household use ·

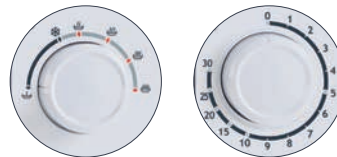

**El complemento indispensable que no puede faltar en la cocina**  
**Plato giratorio, asegura un reparto y un calentamiento uniforme**  
**Gran potencia y capacidad interior, calienta en segundos o cocina en minutos**  
**Incluye la función descongelar**

L'élément indispensable dans la cuisine  
Plato giratório, assegura uma distribuição e um aquecimento uniforme  
Grand puissance et capacité intérieure, réchauffe en quelques secondes et cuisine en quelques minutes. Inclut la fonction décongélation

Ihr unentbehrlicher Küchenhelfer. Drehteller aus Glas sorgt für gleichmäßige Hitzeverteilung und Erwärmung  
Große Leistung und Innenkapazität, erwärmt in wenigen Sekunden und kocht in wenigen Minuten. Einschließlich Auftaufunktion

The essential kitchen accessory  
Turntable ensures even distribution and heating  
Great power and interior capacity, heats in seconds and cooks in minutes.  
Includes defrost function

O complemento indispensável que não pode faltar na cozinha  
Plato giratório, assegura uma distribuição e um aquecimento uniforme  
Grande potência e capacidade interior  
Aquece em segundos e cozinha em poucos minutos. Inclui a função descongelar

**Microondas WHITE**

Micro-ondes  
Mikrowelle  
Microwave  
Microondas

Ref	€	L	Pack
69322	118,30	20	1

Ref	Tensión/Voltage	Potencia/Power	Temporizador/Timer	Capacidad/Capacity	ØPlato/ Plate	Dimensiones/Sizes	Peso/Weight
69322	220-240 V/50 Hz	700 W	30 min	20 L	Ø24,5 cm	45,2x26,2x33,9 cm	10,5 Kg



## Hervidores de agua

· Semiprofessional use ·



### Base conector 360°. Elemento de calefacción oculto Vertido sin cable. Controles de tacto suave Filtro para cal

Base de connexion 360°. Élément de chauffe caché  
Versement sans câble. Commandes au toucher doux  
Filtre anticalcaire

360°-Stecker. Nicht sichtbares Heizelement  
Ausguss ohne Kabel. Berührungsempfindliche Regler  
Kalkfilter

360° connector base. Hidden heating element  
Wireless pouring. Smooth tract controls  
Lime scale filter  
Smooth tract controls

Base do conector 360°. Elemento de aquecimento oculto  
Vertido sem cabo. Controlos de tacto suaves  
Filtro para cal

### Hervidor agua eléctrico

Bouilloire Electrique  
Elektrische Wasserwarmer  
Electric Kettle  
Chaleira Eléctrica

Ref	€	L	Pack
69277	48,00	1,70	1

Ref	Tensión/Voltage	Potencia/Power	Capacidad/Capacity	Dimensiones/Sizes	Peso/Weight
69277	220-240 V / 50-60 Hz	2000 - 2400 W	1,70 L (5 min)	17x24x25 cm	1,10 Kg

· Semiprofessional use ·



### Base conector 360°. Elemento de calefacción oculto Vertido sin cable. Controles de tacto suave Filtro para cal

Base de connexion 360°. Élément de chauffe caché  
Versement sans câble. Commandes au toucher doux  
Filtre anticalcaire

360°-Stecker. Nicht sichtbares Heizelement  
Ausguss ohne Kabel. Berührungsempfindliche Regler  
Kalkfilter

360° connector base. Hidden heating element  
Wireless pouring. Smooth tract controls  
Lime scale filter  
Smooth tract controls

Base do conector 360°. Elemento de aquecimento oculto  
Vertido sem cabo. Controlos de tacto suaves  
Filtro para cal

### Hervidor agua eléctrico

Bouilloire Electrique  
Elektrische Wasserwarmer  
Electric Kettle  
Chaleira Eléctrica

Ref	€	L	Pack
69291	32,10	1,00	1
69297	40,00	1,70	1

Ref	Tensión/Voltage	Potencia/Power	Capacidad/Capacity	Dimensiones/Sizes	Peso/Weight
69291	220-240 V / 50-60 Hz	1650 W	1,00 L (3 min)	22x16x21 cm	1,10 Kg
69297	220-240 V / 50-60 Hz	2200 W	1,70 L (5 min)	22x18x23 cm	1,65 Kg

· Semiprofessional use ·

Inox 18/10 C Glass



**Base conector 360°. Se apagará automáticamente cuando el agua hierva**  
**Elemento de calefacción oculto. Protección de ebullición**  
**Temperatura ajustable (50-95°C)**

Base de connexion 360°. S'éteint automatiquement lorsque l'eau bout  
 Élément de chauffe caché. Protection d'ébullition. Température réglable (50-95°C)

360°-Stecker. Sobald das Wasser kocht, schaltet es automatisch ab  
 Nicht sichtbares Heizelement. Siedeschutz. Einstellbare Temperatur (50-95°C)

360° connector base. It will switch off automatically when the water boils  
 Hidden heating element. Boiling protection. Adjustable temperature (50-95°C)

Base de conector 360°. Apaga-se automaticamente quando a água começa a ferver  
 Elemento de aquecimento oculto. Proteção contra excesso de fervura  
 Temperatura ajustável (50-95°C)

**Hervidor agua eléctrico**

Bouilloire Electrique  
 Elektrische Wasserwarmer  
 Electric Kettle  
 Chaleira Eléctrica

Ref	€	L	Pack
69292	62,80	1,70	1

Ref	Tensión/Voltage	Potencia/Power	Temperatura/Temp.	Capacidad/Capacity	Dimensiones/Sizes	Peso/Weight
69292	220-240 V / 50 Hz	2200 W	50 - 95°C	1,70 L	23x23x32 cm	2,40 Kg

· Household use ·

CE Ceramic Healthy Cooking

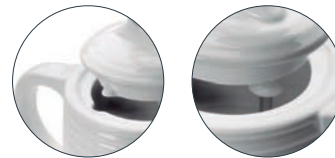

**Función de apagado automático. Interruptor de encendido/apagado luminoso**  
**Protección de sobrecalentamiento y funcionamiento en seco**  
**Tapa extraíble con cierre. Indicador de capacidad máxima**

Fonction d'arrêt automatique. Interrupteur de marche/arrêt lumineux  
 Protection contre la surchauffe et fonctionnement à sec  
 Couvercle extractible avec fermeture. Indicateur de capacité maximale

Automatische Abschaltung. Ein-/Ausschalter mit Leuchtanzeige  
 Schutz gegen Überhitzung und Betrieb ohne Wasser  
 Abnehmbarer Deckel mit Verriegelung. Anzeige für maximale Füllmenge

Auto-off function. Light up on/off switch  
 Protection from overheating and dry running  
 Removable lid with closure. Maximum capacity indicator

Função de desconexão automática. Interruptor de ligar/desligar luminoso  
 Proteção contra sobreaquecimento e funcionamento em seco  
 Tapa extraível com fecho. Indicador de capacidade máxima

**Hervidor cerámico eléctrico GALA**

Bouilloire électrique en céramique  
 Keramik Elektrische Wasserwarmer  
 Ceramic electric kettle  
 Chaleira eléctrica cerámica

Ref	€	L	Pack
69276	38,70	1,30	1

Ref	Tensión/Voltage	Potencia/Power	Capacidad/Capacity	Dimensiones/Sizes	Peso/Weight
69276	220-240 V / 50-60 Hz	1500 W	1,30 L	24x17x25 cm	1,68 Kg

## Cafeteras goteo

· Professional use ·



**Depósito agua**  
Water deposit

**Colocación filtro**  
Filter placement

### Máquina de café automática

Machine à café automatique  
Automatische Kaffeemaschine  
Automatic coffee machine  
Máquina automática do café

	Ref	€	Filtro	Pack
<b>A</b>	69270	234,20	Ø20	1
<b>B</b>	69272	393,10	Ø25	1



Ref	Filtro/Filter	Tensión/Voltage	Potencia/Power	Capacidad/Cap.	Placa calent/Heating plate	Jarra/Termo Pitcher/Thermo	Dimensiones/Sizes	Peso/Weight
69270	69275	220-240 V / 50-60 Hz	1450 W	1,50 L (8 min)	-	1,50 L Termo	17x28x38 cm	4,20 Kg
69272	69274	220-240 V / 50-60 Hz	2100 W	1,80 L (8 min)	2x80 W (80°C +/-4)	1,80 L Jarra (2)	20x36x41 cm	5,82 Kg

### Jarra café cristal

Basse en verre pichet  
Glass Kaffee Krug  
Glass coffee jug  
Caneca de café em vidro



### Pack 200 filtros

Pack 200 filters  
Packung 200 Filter  
200 filters Pack  
Pack 200 filtros



Ref	€	L	h (cm)	Pack
69273	23,00	1,80	17,50	1

Ref	€	Ø (cm)	Pack
69274	12,90	25	10
69275	11,20	20	10

· Professional use ·



### Placa calentamiento jarra café

Plaque chauffante pour cruche de café  
Heizplatte für Kaffeekanne  
Heating plate for coffee jug  
Placa de aquecimento caneca de café

Ref	€	Ø Placa	
69281	75,20	11	Simple
69282	94,00	11	Doble · Double



Ref	Tensión/Voltage	Potencia/Power	Temperatura/Temp.	Dimensiones/Sizes	Peso/Weight
69281	220-240 V / 50-60 Hz	90 W	80°C +/-4	19x20,5x7 cm	0,80 Kg
69282	220-240 V / 50-60 Hz	180 W	80°C + 80°C +/-4	38x20,5x7 cm	1,50 Kg

• Household use •



**Cafetera de goteo**

Cafetière filtre électrique  
Filterkaffe  
Filter coffe machine  
Café tipo filtro

Ref	€	L	Pack
69278	41,00	1,25	1



- 1.- Portafiltro desmontable  
Removable folter holder
- 2.- Base calentadora antiadherente  
Anti-stick heating base

**Puede dosificar la cantidad de café**  
**Una vez encendida nos podemos desentender de ella**  
**Si la jarra se completa, mantiene el café caliente y se puede consumir en cualquier momento**

Peut doser la quantité de café  
Une fois allumée, plus besoin de s'en occuper  
Si la verseau est pleine, elle maintient le café au chaud permettant ainsi de le consommer à tout moment

Kaffee-Dosierung möglich  
Einmal eingeschaltet brauchen wir uns nicht um sie zu kümmern  
Ist die Kanne voll, wird der Kaffee warmgehalten und er kann jederzeit genossen werden

The amount of coffee used can be controlled. Once switched on we can forget about it and leave it to work  
If a full pot is prepared, it keeps the coffee hot and it can be consumed at any time

Pode dosar a quantidade de café  
Uma vez ligada, não temos que nos preocupar mais  
Uma vez cheia, a cafeteira mantém o café quente, e pode consumir-se em qualquer momento

Ref	Tensión/Voltage	Potencia/Power	Tazas/Cups	Capacidad/Capacity	Dimensiones/Sizes	Peso/Weight
69278	220-240 V / 50-60 Hz	1000 W	10	1,25 L	31x21x22 cm	1,25 Kg

• Household use •



**Cafetera de goteo programable**

Cafetière filtre électrique programmable  
Programmierber Filterkaffe  
Filter coffe machine  
Programavel café tipo filtro

Ref	€	L	Pack
69279	58,50	1,80	1



- 1.- Portafiltro desmontable  
Removable folter holder
- 2.- Base calentadora antiadherente  
Anti-stick heating base

**Mantiene el café caliente durante 2 horas. Se apaga automáticamente**  
**Función pausa (antigoteo) para servir**  
**Programmable**

Maintient le café au chaud pendant 2 heures. S'éteint automatiquement  
Fonction pause (anti-goutte) pour servir  
Programmable

Hält den Kaffee 2 Stunden warm. Automatische Abschaltung  
Pause-Funktion (tropffrei) zum Ausschenken  
Programmierbar

Keeps the coffee hot for 2 hours. Switches off automatically  
Pause (anti-drip) function for serving  
Programmierbar

Mantém o café quente durante 2 horas. Apaga-se automaticamente  
Função de pausa (anti-gotejo) para servir  
Programável

Ref	Tensión/Voltage	Potencia/Power	Tazas/Cups	Capacidad/Capacity	Dimensiones/Sizes	Peso/Weight
69279	220-240 V / 50-60 Hz	900 W	12	1,80 L	28x25x37 cm	3,10 Kg



# Espumador de leche

**New**

· Household use ·



**Espumador 3 en 1: Permite espumar leche caliente, fría o simplemente calentar**  
**Disfruta de una espuma fina y cremosa en tan solo 100 segundos**  
**El termostato interno controla el proceso de calentamiento para que la leche alcance la temperatura adecuada**  
**Capacidad espuma: 115 ml / Capacidad calentamiento: 240 ml**  
**Base de 360°. Funcionamiento silencioso. Inalámbrico, fácil de rellenar y verter**  
**Apagado automático cuando la leche esté lista**  
**Revestimiento antiadherente de gran calidad. Carcasa fría al tacto**  
**2 accesorios batidores, uno para el proceso solo calentamiento y otro para espuma**  
**Tapa transparente con soporte para guardar el accesorio batidor que no se esté utilizando**  
**Fácil de limpiar**

Mousseur 3 en 1 : Permet de faire de la mousse de lait chaud, de lait froid ou simplement chauffer  
 Obtenez une mousse fine et crémeuse en 100 secondes seulement  
 Le thermostat interne contrôle le processus de chauffe pour que le lait atteigne la température appropriée  
 Capacité mousse : 115 ml / Capacité chauffe : 240 ml  
 Base de 360°. Fonctionnement silencieux. Sans fil, facile à remplir et à verser  
 Arrêt automatique lorsque le lait est prêt  
 Revêtement antiadhésif de haute qualité. Corps toucher froid  
 2 accessoires batteurs, l'un pour le processus uniquement de chauffe et l'autre pour la mousse  
 Couvercle transparent avec support pour ranger l'accessoire batteur non utilisé  
 Facile à nettoyer

Dreierartiger Aufschäumer: Ermöglicht kaltes und warmes Aufschäumen oder nur Erwärmen  
 Samtiger Schaum in nur 100 Sekunden genussbereit  
 Eingebautes Thermostat kontrolliert Erwärmung, damit die Milch die richtige Temperatur erreicht  
 Milchschaum bis zu 115 ml / heiße Milch bis zu 240 ml  
 360°-Untersatz. Geräuscharm. Ohne Kabel einfach ein- und ausgießen  
 Automatische Abschaltung am Ende der Milchzubereitung  
 Hochwertige Anti-Haftbeschichtung. Außenhülle heizt sich nicht auf  
 2 Quirls, einer zum Aufschäumen und einer NUR zum Erwärmen  
 Durchsichtiger Deckel kann nicht verwendeten Zusatzquirl aufnehmen  
 Leichte Reinigung

3 in 1 Frother: Allows you to froth hot or cold milk, or simply warm it  
 Enjoy a fine, creamy foam in as little as 100 seconds  
 The internal thermostat controls the heating process so that the milk reaches the correct temperature  
 Foaming capacity: 115ml / Heating capacity: 240ml  
 360° rotating base. Silent operation. Cordless, easy to fill and pour  
 Switches off automatically when the milk is ready  
 High-quality non-stick coating. The casing cold to the touch  
 2 whisking accessories, one ONLY for the heating process and the other for frothing  
 Transparent lid with a bracket to hold the whisking utensil that it is not being used  
 Easy to clean

Espumador 3 em 1: Para espumar leite quente, frio ou aquecer o leite  
 Desfrute de uma espuma fina e cremosa em apenas 100 segundos  
 O termostato interno controla o processo de aquecimento para que o leite alcance a temperatura adequada  
 Capacidade de espuma: 115 ml / Capacidade de aquecimento: 240 ml  
 Base de 360°. Funcionamento silencioso. Sem fios, fácil de encher e de verter  
 Desconexão automática quando o leite está pronto  
 Revestimento antiaderente de alta qualidade. Carcaça fria ao tato  
 2 acessórios para bater, um para aquecer o leite, e outro para espumar  
 Tapa transparente com suporte para guardar o acessório batedor que não se utiliza  
 Fácil de limpar



**3 in 1**

Espumar leche caliente  
 Espumar leche fría  
 Simplemente calentar

Faire de la mousse de lait chaud  
 Faire de la mousse de lait froid  
 Simplement chauffer

Froth hot milk  
 Froth cold milk  
 Or simply warm it

## Espumador de leche

Mousseur à lait  
 Milchaufschäumer  
 Milk frother  
 Espumador de leite

Ref	€	W	Pack
69396	49,90	500	1

Ref	Tensión/Voltage	Potencia/Power	Cap. espuma/Cap. foam	Cap. leche/Cap. milk	Base/Base	Dimensiones/Sizes	Peso/Weight
69396	220-240 V / 50-60 Hz	500 W	115 ml	240 ml	360°	Ø10x21 cm	650 g

# Airpots

· Professional use ·

**New**

*ideal para agua, café y té*  
*Perfect for water, coffee and tea*



**Fácil sistema de apertura**  
Système d'ouverture facile  
Leicht zu öffnen  
Easy open system  
Sistema de abertura fácil



**Nivel de indicador de líquido**  
Niveau d'indicateur de liquide  
Flüssigkeitsfüllstand  
Liquid level indicator  
Nível de indicador do líquido



**Sistema dispensador cómodo**  
Système de distribution pratique  
Bequemes Spendersystem  
Convenient dispensing system  
Prático sistema dispensador



**Sensor de temperatura en el interior**  
Capteur de température à l'intérieur  
Temperaturfühler im Innern  
Interior temperature sensor  
Sensor de temperatura no interior



**Marcas de llenado**  
Marques de remplissage  
Füllstandsmarkierungen  
Fill lines  
Marcas de nível de enchimento



**Posibilidad de graduar la temperatura**  
Possibilité de régler la température  
Temperaturregelung möglich  
The temperature can be adjusted  
Possibilidade de graduar a temperatura

**Dispensador con capacidades de 6 y 10 litros**  
**Fabricado en acero inoxidable resistente y de alta calidad**  
**Dispone de un grifo dispensador con indicador de nivel de líquido**  
**Temperatura controlada por termostato con un rango de 60°C a 100°C**  
**Dispone de asas laterales aislantes del calor para un desplazamiento seguro**  
**NO se recomienda usar con lácteos por la posible contaminación, debido a restos fermentados**  
**Si se usan lácteos es necesario ser cuidadoso y constante en la limpieza del contenedor**

Distributeur d'une capacité de 6 litres et de 10 litres.  
Fabriqué en acier inoxydable résistant et de grande qualité.  
Dispose d'un robinet de distribution avec indicateur du niveau de liquide.  
Température contrôlée par thermostat dans une tranche de 60°C à 100°C  
Dispose de poignées latérales isolantes de la chaleur pour un déplacement sûr  
Il est DÉCONSEILLÉ d'utiliser des produits laitiers en raison de l'éventuelle contamination due aux restes fermentés  
Si vous utilisez des produits laitiers, il faudra être très vigilant et constant en matière de nettoyage du conteneur

Dispenser mit 6 und 10 Liter Füllmenge  
Aus widerstandsfähigem, hochwertigem Edelstahl hergestellt  
Verfügt über einen Spenderhahn mit Flüssigkeitsfüllstandsanzeige  
Temperaturregelung mithilfe eines Thermostats zwischen 60 und 100 °C  
Mit seitlichen, wärmeisolierten Griffen für einen sicheren Transport  
Von der Verwendung von Milchprodukten wird wegen möglicher vorhandener vergärrer Reste ABGERATEN  
Wenn Milchprodukte verwendet werden, ist Sorgfalt geboten und das Behältnis gründlich zu reinigen

6 and 10 litre capacity beverage dispensers  
Made of strong high quality stainless steel  
Includes a spigot with a level indicator  
Temperature controlled by a thermostat with a range from 60° C to 100° C  
Side mounted insulated handles for safe moving  
The dispenser should NOT be used with dairy products due to possible contamination from fermented residue  
If dairy products are used, the dispenser must be cleaned carefully and frequently

Dispensador com capacidade para 6 e 10 litros  
Fabricado em aço inoxidável resistente e de alta qualidade  
Com torneira dispensadora com indicador de nível do líquido  
Temperatura controlada por termóstato regulável de 60 a 100° C  
Dispõe de asas laterais isoladoras do calor para uma deslocação segura  
NÃO se recomenda o seu uso com lácteos pela possível contaminação devido à existência restos fermentados  
Ao utilizar lácteos, é importante ter os devidos cuidados no que se refere à limpeza do recipiente



**Airpot eléctrico**

Électrique Airpot  
Elektrische Getrankenspender  
Electric Airpot  
Airpot eléctrico

Ref	€	L	Pack
69476	112,20	6	1
69471	122,60	10	1

Ref	Tensión/Voltage	Potencia/Power	Capacidad/Capacity	Temperatura/Temp.	Dimensiones/Sizes	Peso/Weight
69476	220-240 V / 50-60 Hz	1500 W	6 L	60°C - 100°C	28x28x40 cm	1,90 Kg
69471	220-240 V / 50-60 Hz	1500 W	10 L	60°C - 100°C	28x28x48 cm	2,00 Kg

• Professional use •



#### Airpot eléctrico

Électrique Airpot  
Elektrische Getrankenpender  
Electric Airpot  
Airpot eléctrico

Ref	€	Pack
69473	87,70	1
69474	92,10	1

*Ideal para agua, café y té*  
Perfect for water, coffee and tea

#### Sistema de apertura sencillo

Fácil llenado

Tres dispensadores

Función cleaning y base giratoria

Tapa extraíble para su limpieza

Si se usan lácteos es necesario ser cuidadoso y constante en la limpieza del contenedor

Système d'ouverture simple

Remplissage facile

Trois distributeurs

Fonction Nettoyage et pivotant

Couvercle amovible pour un nettoyage

Si vous utilisez des produits laitiers, il faudra être très vigilant et constant en matière de nettoyage du conteneur

Einfache Öffnung system

Einfache Befüllung

Drei Spender

Reinigungsfunktion und Swivel

Abnehmbarer Deckel für die Reinigung

Wenn Milchprodukte verwendet werden, ist Sorgfalt geboten und das Behältnis gründlich zu reinigen

Simple opening system

Easy filling. Three dispensers

Cleaning function and swivel base

Removable cover for cleaning

If dairy products are used, the dispenser must be cleaned carefully and frequently

Sistema simple de abertura

Fácil enchimento

Três distribuidores

Função de limpeza e suporte giratório

Tampa removível para limpeza

Ao utilizar lácteos, é importante ter os devidos cuidados no que se refere à limpeza do recipiente

Ref	Tensión/Voltage	Potencia/Power	Temperatura/Temp.	Capacidad/Capacity	Dimensiones/Sizes	Peso/Weight
69473	220-240 V / 50-60 Hz	750 W	30°C - 100°C	3,50 L	29x29x35 cm	2,80 Kg
69474	220-240 V / 50-60 Hz	750 W	30°C - 100°C	4,50 L	29x29x39 cm	3,00 Kg

## Tostadoras

· Professional use ·



**Especialmente indicado para el uso en el buffet**  
**Tostadora eléctrica con cinta transportadora**  
**Tostado continuo de pan de forma rápida y ordenada**  
**Mando velocidad ajustable y doble sistema de calentamiento**

Particulièrement indiqué pour une utilisation dans les buffets  
 Grille-pain électrique avec convoyeur  
 Brunissage continu du pain de façon rapide et ordonnée  
 Commande vitesse réglable et double système de chauffe

Besonders für Gebrauch am Buffet geeignet  
 Elektrischer Toaster mit Förderband  
 Fortlaufendes Rösten des Brots - schnell und ordentlich  
 Einstellbarer Geschwindigkeitsregler und doppeltes Röstsystem

Particularly suitable for buffet use  
 Electric toaster with conveyor belt  
 Quick, orderly and continuous bread toasting  
 Adjustable speed control and dual heating system

Especialmente indicada para utilização em buffets  
 Torradeira elétrica com cinta transportadora  
 Torragem contínua do pão de forma rápida e limpa  
 Comando de velocidade regulável, e duplo sistema de aquecimento

### Tostadora eléctrica de cinta transportadora

Toasteur électrique professionnel  
 Elektrischer Durchlauf toaster  
 Electrical conveyor toaster  
 Torradeira eléctrica de tapete rolante

Ref	€	Pack
69065	656,40	1
69066	764,60	1

Ref	Tensión/Voltage	Potencia/Power	Producción/Product.	Dimensiones/Sizes	Peso/Weight
69065	220-240 V / 50-60 Hz	1340 W	150/h	53x37x40 cm	16 Kg
69066	220-240 V / 50-60 Hz	2240 W	300/h	53x45x40 cm	19 Kg

· Professional use ·

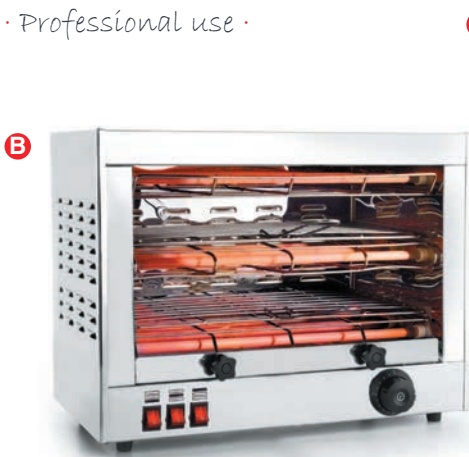

**Ideal para la preparación de tostadas en buffets**  
**Cuerpo de acero inoxidable, robusto, duradero y con parrilla doble**  
**Lámparas infrarrojas halógenas de cuarzo. Calentamiento infrarrojos**  
**Bandeja recogemigas**

Idéal pour la préparation de toast dans les buffets  
 Corps en acier inoxydable, robuste, durable et avec double grill  
 Lampes à infrarouges halogènes en quartz. Chauffe à infrarouges  
 Plateaux ramasse-miettes

Ideal für die Zubereitung von Toast am Buffet  
 Gehäuse aus rostfreiem Stahl, robust, haltbar und mit doppeltem Grillrost  
 Infrarot Halogenquarzlampen. Infrarotheizstrahler  
 Krümelauffangtablett

Ideal for making toast in buffets  
 Sturdy and durable stainless steel body with double grill  
 Quartz halogen infrared lamps. Infrared heating  
 Crumb tray

Ideal para preparar torradas em buffets  
 Corpo de aço inoxidável, robusto, e durável, com grelha dupla  
 Lâmpadas halogêneas de infravermelhos de quartzo. Aquecimento por infravermelhos  
 Bandeja recolhadora de migalhas.

### Tostador eléctrico horizontal

Grille-pain électrique horizontal  
 Horizontal-/elektrogrill  
 Electric horizontal  
 Torradeira eléctrica horizontal

Ref	€	Pack	
<b>A</b> 69172	274,10	1	<b>Simple</b>
<b>B</b> 69173	330,50	1	<b>Doble · Double</b>

Ref	Tensión/Voltage	Potencia/Power	Temperatura/temp.	Lámparas/Lamps	Dimensiones/Sizes	Peso/Weight
69172	220-240 V / 50-60 Hz	2400 W	320°C (max)	4 (2+2)	50x25x28 cm	8,40 Kg
69173	220-240 V / 50-60 Hz	3600 W	320°C (max)	6 (2+2+2)	50x25x38 cm	9,60 Kg



· Semiprofessional use ·



**Tostadora Buffet Inox 4-6 ranuras**

Grille-pain buffet pour 4-6 tranches  
Buffet-Toaster für 4-6 Brotscheiben  
4-6 slots st steel buffet toaster  
Torradeira buffet 4-6 fatias de pão

**Possibilidad de seleccionar 2-4-6 ranuras para tostar**  
**Palanca para extraer las tostadas**  
**Bandeja recogemigas**

Possibilité de sélectionner 2-4-6 fentes de grillage  
Lévier pour enlever des toasts  
Plateau ramasse-miettes

Fähigkeit, 2-4-6 Röstschacht wählen  
Hebel zum Entfernen von Toast  
Krümelauffangblech

Ability to select 2-4-6 toasting slots  
Lever for removing toast  
Crumb-collection tray

Capacidade de seleccionar 2-4-6 ranhuras para brindam  
Alavanca para a remoção de brinde  
Bandeja recolhe-migas

Ref	€	Pack
<b>A</b> 69294	183,80	1
<b>B</b> 69296	244,20	1

Ref	Tensión/Voltage	Potencia/Power	Selector/Selector	Ranuras/Slots	Dimensiones/Sizes	Peso/Weight
69294	220-240 V / 50-60 Hz	1800 W	2-4 ranuras · 2-4 groves	15x3 cm	37x21x22 cm	4,80 Kg
69296	220-240 V / 50-60 Hz	2500 W	2-4-6 ranuras · 2-4-6 groves	15x3 cm	46x22,5x22 cm	6,0 Kg

· Household use ·



**Tostadora LUXE para 2-4 rebanadas de pan**

Grille-pain LUXE pour 2-4 tranches de pain  
LUXE-Toaster für 2-4 Brotscheiben  
LUXE 2-4 slice toaster  
Torradeira LUXE para 2-4 fatias de pão

**Ranuras de grandes dimensiones para tostar cualquier tipo de pan**  
**Bandeja recogemigas**

Rainures de très grandes dimensions pour griller tout type de pain  
Plateau ramasse-miettes

Großformatige Schlitzte zum Toasten aller Brotsorten  
Krümelauffangblech

Huge slots for toasting any type of bread  
Crumb-collection tray

Ranuras de grandes dimensões para tostar qualquer tipo de pão  
Bandeja recolhe-migas

Ref	€	Slots
<b>A</b> 69162	65,50	2
<b>B</b> 69164	80,30	4

Ref	Tensión/Voltage	Potencia/Power	Selector/Selector	Ranuras/Slots	Dimensiones/Sizes	Peso/Weight
69162	220-240 V / 50-60 Hz	850 W	2 ranuras · 2 groves	14x4 cm	32x18x19 cm	2,55 Kg
69164	220-240 V / 50-60 Hz	1400 W	2 ranuras · 2 groves	14x4 cm	32x26x19 cm	2,70 Kg

· Household use ·



**Ranuras de grandes dimensiones para tostar cualquier tipo de pan  
7 posiciones de calentamiento, tostado uniforme en ambos lados  
Bandeja recogemigas**

Rainures de très grandes dimensions pour griller tout type de pain  
7 positions de chauffe, brunissage uniforme des deux côtés  
Plateau ramasse-miettes

Großformatige Schlitze zum Toasten aller Brotsorten  
7 Erwärmungspositionen, gleichförmiges Toasten auf beiden Seiten  
Krümelauffangblech

Huge slots for toasting any type of bread  
7 heating positions, uniform toast on both sides  
Crumb-collection tray

Ranuras de grandes dimensões para tostar qualquer tipo de pão  
7 posições de aquecimento, tostado uniforme de ambos os lados  
Bandeja recolhe-migas

**Tostadora automática para 2-4 rebanadas de pan**

Grille-pain automatique pour 2-4 tranches de pain  
Automatik-Toaster für 2-4 Brotscheiben  
Automatic 2-4 slice toaster  
Torradeira automática para 2-4 fatias de pão

	Ref	€	Slots
<b>A</b>	69062	40,50	2
<b>B</b>	69064	61,10	4

Ref	Tensión/Voltage	Potencia/Power	Selector/Selector	Ranuras/Slots	Dimensiones/Sizes	Peso/Weight
69062	220-240 V / 50-60 Hz	850 - 1000 W	2 ranuras · 2 groves	14x4 cm	19x29x19 cm	1,40 Kg
69064	220-240 V / 50-60 Hz	1750 W	2 ranuras · 2 groves	14x4 cm	33x29x19cm	3,10 Kg

· Household use ·



**Doble ranura de grandes dimensiones para tostar cualquier tipo de pan  
7 posiciones de calentamiento, tostado uniforme en ambos lados  
Opción de descongelar pan  
Bandeja recogemigas**

Double rainure de très grandes dimensions pour griller tout type de pain  
7 positions de chauffe, brunissage uniforme des deux côtés  
Option de décongélation du pain  
Plateau ramasse-miettes

Großformatiger Doppelschlitz zum Toasten aller Brotsorten  
7 Erwärmungspositionen, gleichförmiges Toasten auf beiden Seiten  
Brotauftau-Option  
Krümelauffangblech

Huge double slot for toasting any type of bread  
7 heating positions, uniform toast on both sides  
Bread defrost option  
Crumb-collection tray

Dupla ranhura de grandes dimensões, para tostar qualquer tipo de pão  
7 posições de aquecimento, tostado uniforme de ambos os lados  
Opção para descongelar pão  
Bandeja recolhe-migas

**Tostadora doble ranura larga**

Grille pain double rainure longue  
Doppelte lange öffnung toaster  
Double long groovee toaster  
Dorradeira ranhua large duplo

	Ref	€	Pack
	69260	47,80	1

Ref	Tensión/Voltage	Potencia/Power	Selector/Selector	Dimensiones/Sizes	Peso/Weight
69260	220-240 V / 50-60 Hz	1200 - 1500 W	Dos ranuras · Two groves	43x20x23 cm	3,10 Kg

# Tostadoras

· Household use ·



**Fabricada en acero inoxidable 18/10 de gran calidad y resistencia**  
**Permite tostar de forma rápida y sencilla, sin necesidad de añadir grasa alguna**  
**Función de descongelación y cancelación**  
**Regulador ajustable de tueste, elige entre 7 niveles para tostar a tu gusto**  
**Ranura alargada de 25 cm de largo para rebanadas extra largas o para más de una rebanada de pan**  
**Parrilla adicional para calentar bollos o pan**  
**Incorpora una práctica bandeja, donde se depositan las migas**

Fabriquée en acier inoxydable 18/10 d'une grande qualité et résistance  
 Permet de griller de façon rapide et simple sans nécessité d'ajouter aucune graisse  
 Fonction de décongélation et d'arrêt  
 Régulateur de brunissage réglable : choisissez parmi 7 niveaux pour griller selon vos souhaits  
 Rainure allongée de 25 cm de longueur pour des tranches extra larges ou pour plus d'une tranche de pain  
 Grille supplémentaire pour réchauffer des viennoiseries ou du pain  
 Intègre un plateau pratique sur lequel se déposent les miettes

Aus widerstandsfähigem und hochwertigem Edelstahl 18/10  
 Für einfaches und schnelles Toasten ohne Fett  
 Mit Auftau- und Abbruchtaste  
 Einstellbarer Regler mit 7 Bräunungsstufen ganz nach dem eigenen Geschmack  
 Extra lange Röstkammer (25 cm) für eine große oder mehrere kleine Brotscheiben  
 Zusätzliches Rost zum Erwärmen von Brötchen oder Brot  
 Mit praktischer Krumenwanne

Made of strong high quality 18/10 stainless steel  
 Fast and easy toasting without the need to use any fatty products  
 Defrost and cancel functions  
 Adjustable darkness regulator. Choose from 7 levels for toasting as you like.  
 Long 25 cm slot for extra wide slices of bread or more than one slice of bread at once  
 Additional grill to heat buns or bread  
 It has a practical tray for catching crumbs

Fabricada em aço inoxidável 18/10, de grande qualidade e resistência  
 Permite tostar de forma rápida e fácil, sem necessidade de acrescentar nenhum tipo de gordura  
 Função de descongelação e botão de cancelamento  
 Regulador de tostagem com 7 níveis diferentes, para o ajustar ao gosto pessoal  
 Ranhura longa de 25 cm para fatias extra longas, ou para mais do que uma fatia de pão  
 Grelha adicional para aquecer bolos ou pão  
 Incorpora uma prática bandeja para recolher as migalhas



**Termostato: 7 posiciones de tostado**  
 Thermostat: 7 positions grillées  
 Thermostat: 7 Positionen geröstet  
 Thermostat: 7 positions toasted  
 Termostato: 7 posições brindado



**Dispone de función descongelar**  
 Dispose d'une fonction de décongélation  
 Mit Auftaufunktion  
 It has a defrost function  
 Com função de descongelação



**Bandeja recogemigas**  
 Plateau ramasse-miettes  
 Krümelbehälter  
 Crumb tray  
 Bandeja recolhe-migalhas



**Patas de apoyo antideslizantes**  
 Pieds d'appui antidérapants  
 Rutschfeste standfüße  
 Non-slip supports  
 Patas de apoio antideslizantes

**New**

*Ranura alargada de 25 cm de largo*  
 Long 25 cm slot for extra wide slices



**Tostadora eléctrica ranura larga**  
 Grille-pain électrique rainure longue  
 Elektrotoaster, lange Öffnung  
 Long groove electric toaster  
 Torradeira eléctrica ranhuras largas

Ref	€	Pack
69360	49,20	1

*Ranura alargada de 25 cm de largo*  
 Long 25 cm slot for extra wide slices



**Tostadora eléctrica ranura larga**  
 Grille-pain électrique rainure longue  
 Elektrotoaster, lange Öffnung  
 Long groove electric toaster  
 Torradeira eléctrica ranhuras largas

Ref	€	Pack
69060	38,70	1

**Hasta fin de existencias** · While stocks last

Ref	Tensión/Voltage	Potencia/Power	Selector/Selector	Dimensiones/Sizes	Peso/Weight
69060	220-240 V / 50-60 Hz	850 W	Una ranura · One groove	17x24x25 cm	1,10 Kg
69360	220-240 V / 50-60 Hz	1000 W	Una ranura · One groove	41X12X18,5 cm	1,40 Kg

· Household use ·



**Tostadora eléctrica horizontal**

Toaster électrique horizontal  
Horizontal-/Elektrotoaster  
Electric horizontal toaster  
Torradeira eléctrica horizontal

	Ref	€	Pack
<b>A</b>	69163	26,70	1
<b>B</b>	69363	33,70	1

**Gracias a su diseño y área de calentamiento podrá tostar todo tipo de panas o bollería y varias rebanadas a la vez  
6 posiciones de calentamiento. Aviso sonoro. Bandeja recogemigas**

Grâce à sa conception et sa zone de chauffe, vous pourrez griller tout type de pains ou de viennoiseries et plusieurs tranches à la fois  
6 positions de chauffe. Avertissement sonore. Plateau ramasse-miettes

Dank des Designs und des Erwärmungsbereichs können Sie alle möglichen Brotsorten und mehrere Scheiben gleichzeitig toasten  
6 Erwärmungspositionen. Akustisches Signal. Krümel auffangblech

Thanks to its design and heating area you will be able to toast all types of bread and pastries, and several slices at a time  
6 heating positions. Alarm. Crumb-collection tray

Graças ao seu desenho e área de aquecimento, poderá tostar todo o tipo de pães ou bolos, e várias fatias ao mesmo tempo  
6 posições de aquecimento. Aviso sonoro. Bandeja recolhe-migas

Ref	Tensión/Voltage	Potencia/Power	Temperatura/Temp.	Tostado/Toasted	Parrilla/Grill	Dimensiones/Sizes	Peso/Weight
69163	220-240 V / 50-60 Hz	600 W	360°C	6	25x20 cm	36x21x6,5 cm	1,00 Kg
69363	220-240 V / 50 Hz	600 W	360°C	6	25x20 cm	42x30x9 cm	1,00 Kg

## Quemador

· Professional use ·

**Quemador eléctrico redondo**

Fer à caraméliser électrique rond  
Elektro-Brenner, rund  
SRound electric caramelizer  
Queimador eléctrico redondo



**Ideal para elaboraciones de cocina y repostería que requieran caramelizar de forma rápida y homogénea  
Deja una fina capa dorada y crujiente**

Idéal pour des préparations de cuisine et de pâtisserie qui requièrent une caramélisation rapide et homogène  
Laisse une fine couche dorée et croustillante

Ideal für Küchengerichte und Desserts, die ein schnelles und homogenes Karamellisieren erfordern  
Bildet einen dünnen und knusprigen Überzug

Ideal for cooking and pastry making that requires quick and even caramelizing  
It leaves a thin golden and crunchy layer

Ideal para elaborações de cozinha e pastelaria, que queiram uma caramelização rápida e homogénea  
Cria uma capa fina dourada e estaladiça

Ref	€	Pack
68651	88,70	1
68652	102,50	1

Ref	Tensión/Voltage	Potencia/Power	Dimensiones/Sizes	Peso/Weight
68651	220-240 V / 50-60 Hz	650 W	Ø10 cm	1,132 Kg
68652	220-240 V / 50-60 Hz	1000 W	Ø12 cm	1,268 Kg



## Exprimidores

· Professional use ·



### Exprimidor eléctrico Profesional

Presse-fruits électrique Professionnelle  
Elektrischer Profi-Zitruspresse  
Professional electric squeezer  
Espremedor eléctrico Profissional

Ref	€	Pack
69286	175,80	1

Ref	Tensión/Voltage	Potencia/Power	Velocidad/Speed	Dimensiones/Sizes	Peso/Weight
69286	220-240 V / 50-60 Hz	180 W	1.350 r.p.m.	31x22x35 cm	5,50 Kg

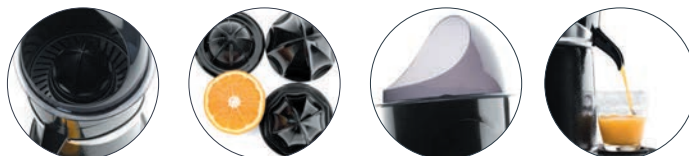

**Extrae el zumo de los cítricos sin esfuerzo**  
**Constituido por un robusto bloque de hierro fundido que ofrece una sólida base**  
**3 conos diferentes, lo que permite obtener el máximo rendimiento de diferentes tipos de cítricos**  
**Con protector de salpicaduras**

Extrait le jus d'agrumes sans effort  
Constitué d'un robuste bloc en fonte qui confère une base solide  
3 cônes différents, ce qui permet d'obtenir un rendement maximum de différents types d'agrumes  
Doté d'une protection contre les éclaboussures

Extrahieren Sie den Saft von Zitrusfrüchten ohne Mühe  
Besteht aus einem robusten Gusseisenblock, der eine solide Basis mit 3 verschiedenen Kegeln darstellt, sodass die maximale Leistung für verschiedene Zitrusfrüchte erzielt wird  
Mit Spritzschutz

Extract the juice of citrus fruits without the effort  
Consisting of a robust cast iron block that offers a solid base  
3 different cones which allow you to extract maximum juice from different types of citrus fruits  
Comes with a splash guard

Extraia o suco de frutas cítricas sem o esforço  
Formado por um bloco de ferro fundido, que proporciona uma base sólida  
3 cones diferentes, que permitem obter o máximo rendimento de diferentes tipos de cítricos  
Proteção contra salpicaduras



· Professional use ·



### Exprimidor eléctrico Profesional

Presse-fruits électrique Professionnelle  
Elektrischer Profi-Zitruspresse  
Professional electric squeezer  
Espremedor eléctrico Profissional

Ref	€	Pack
69283	350,30	1

Ref	Tensión/Voltage	Potencia/Power	Velocidad/Speed	Dimensiones/Sizes	Peso/Weight
69283	220-240 V / 50-60 Hz	230 W	980 r.p.m	28x20x40 cm	10,50 Kg

**Sistema de puesta en marcha automática al presionar la palanca**  
**Cono de acero inoxidable extraíble, apto para el lavavajillas hasta 90°C**  
**Tiempo máximo de funcionamiento: 30 minutos**

Système de mise en marche automatique en appuyant sur le levier  
Cône en acier inoxydable extractible, compatible avec le lave-vaisselle jusqu'à 90°C  
Durée maximum de fonctionnement : 30 minutes

Automatischer Startmechanismus nach Betätigung des Hebels  
Herausnehmbarer Edelstahlkonus, bis 90°C waschmaschinenfest  
Maximale Betriebsdauer: 30 Minuten

Automatic start-up system on pressing the lever  
Removable stainless steel cone, dishwasher safe up to 90°C  
Maximum operating time: 30 minutes

Sistema de posta em funcionamento automática, ao pressionar a alavanca  
Cone de aço inoxidável extraível, apto para a máquina de lavar louça até 90 °C  
Tempo máximo de funcionamento: 30 minutos



• Household use •



**Exprimidor zumo eléctrico con brazo**  
 Presse-fruits Electrique avec levier  
 Elektrische Zitruspresse mit arm  
 Electric squeezer with lever  
 Espremedor se sumos eléctrico com braço

	Ref	€	Pack
<b>A</b>	69285	52,90	9
<b>B</b>	69120	76,60	4

**Sistema de bloqueo de salida de zumo y anti-goteo**  
**El zumo se va almacenando en el contenedor**  
**Para extraer el zumo del contenedor, mueva la boquilla hacia abajo**

Système de blocage de sortie de jus et système anti-goutte  
 Le jus s'accumule dans le conteneur  
 Pour extraire le jus du conteneur, déplacer le bec vers le bas

Saftaustrittssperre und Antitropf-Funktion  
 Der Saft wird im Behälter aufgefangen  
 Um den Saft aus dem Behälter zu entnehmen, drehen sie den Hahn nach unten

Anti-drip and juice outlet blockage system  
 The juice is stored in the container  
 To extract the juice from the container, move the nozzle downwards

Sistema de bloqueio de saída de sumo e anti-gotejo  
 O sumo vai-se armazenando no recipiente  
 Para extrair o sumo do contendor, mova a boquilha para baixo

Ref	Tensión/Voltage	Potencia/Power	Dimensiones/Sizes	Peso/Weight
69285	220-240 V / 50 Hz	100 W	Ø20x29 cm	1,75 Kg
69120	220-240 V / 50-60 Hz	120 W	Ø20x32 cm	4,15 Kg

• Household use •



**Exprimidor naranjas eléctrico**  
 Presse-fruit électrique  
 Elektrische Zitruspresse  
 Electric orange squeezer  
 Espremedor de laranjas eléctrico

Ref	€	Pack
69287	54,20	1

**Ideal para exprimir frutas cítricas**  
**Accionamiento y puesta en marcha presionando el cono hacia abajo**  
**Sistema de bloqueo de salida de zumo y función anti-goteo sin salpicaduras**  
**Opción de almacenar el zumo en el contenedor o exprimirlo directamente al vaso**

Parfait pour presser des fruits citriques  
 Actionnement et mise en marche en pressant le cône vers le bas  
 Système de blocage de sortie de jus et fonction anti-goutte sans éclaboussures  
 Possibilité de conserver le jus dans le conteneur ou bien de le presser directement dans le verre

Ideal zum Entsaften von Zitrusfrüchten  
 Bedienung und Betrieb durch Herunterdrücken des Presskegels  
 Dichtungssystem und Tropfstop-Mechanismus, um Austreten von Saft und Spritzer zu vermeiden  
 Wahlweise den Saft direkt ins Glas pressen oder im Behälter auffangen

Ideal for juicing citrus fruits  
 Activate just by pressing the cone downwards  
 A juice blocking system with anti-drip function without splashing  
 You can choose whether to juice it into a container, or directly into a cup

Ideal para espremer cítricos  
 Aconamento e posta em funcionamento pressionando o cone para baixo  
 Sistema de bloqueio de saída de sumo e função anti-gotejamento sem salpicaduras  
 Opção de armazenar o sumo no recipiente, ou espreme-lo diretamente para o copo

Ref	Tensión/Voltage	Potencia/Power	Dimensiones/Sizes	Peso/Weight
69287	220-240 V / 50-60 Hz	100 W	18x16,5x25 cm	1,90 Kg

## Slow Juicer

· Household use ·



100% saludables  
100% healthy

**Jugos de frutas y verduras 100% saludables con el fin de disfrutar de una vida sana y saludable**

**Garantiza la extracción de zumos con la mínima pérdida de nutrientes u oxidación**

**Diseño moderno e innovador**

**Permiten introducir los ingredientes enteros**

Des jus de fruits et de légumes 100% sains afin de profiter d'une vie saine  
Garantit l'extraction du jus avec une perte minimum de nutriments ou d'oxydation  
Design moderne et innovant  
Permet d'introduire les ingrédients entiers

Reine Frucht- und Gemüsesäfte für ein kerngesundes Leben  
Entsaftung garantiert geringsten Nährstoffverlust und Oxidation  
Modernes und innovatives Design  
Zutaten können am Stück verarbeitet werden

100% healthy fruit and vegetable juices in order to enjoy a healthy life  
Guarantees the extraction of juices with minimal loss of nutrients or oxidation  
Modern and innovative design  
Accommodates whole ingredients

Sumos de frutas e de verduras 100% saudáveis, para desfrutar de uma vida saudável e equilibrada

Para extrair os sumos minimizando a perda de nutrientes e a oxidação

Design moderno e inovador

Permite introducir os ingredientes inteiros



### Exprimidor lento

Presse-agrumes lent

Langsamer Fruchtsafters

Slow juicer

Espremedor lento

Ref	€	Pack
69372	204,50	1

### Exprimidor lento alto

Presse-agrumes lent haute

Langsamer Fruchtsafters, Hoch

High slow juicer

Espremedor lento alto

Ref	€	Pack
69373	335,80	1

Ref	Tensión/Voltage	Potencia/Power	Velocidad/Speed	Capacidad/Capacity	Dimensiones/Sizes	Peso/Weight
69372	230 V / 50-60 Hz	200 W	80 r.p.m	1,0 L	30x16x41 cm	5,50 Kg
69373	230 V / 50-60 Hz	240 W	60 r.p.m	1,0 L	29x20x44 cm	7,30 Kg





**Tecnología "SLOW"** . Mediante el sistema de rotación lenta y el método de prensado en frío, permite obtener todos los nutrientes de frutas y verduras a diferencia de los exprimidores tradicionales  
**Ultra silencioso.** Gracias a su motor de bajas revoluciones  
**Bloqueo de salida**  
**Mezcla frutas y verduras en el interior del recipiente antes de verterlo en la jarra**  
**Exprime frutas y verduras enteras**  
**Introduce los ingredientes enteros permitiendo acelerar el tiempo dedicado a la extracción del zumo**  
**Fácil limpieza. Cepillo para limpiar las partes internas. Accesorios aptos para el lavavajillas**



Technologie "LENTE" . Par son Systeme de rotation lente et la méthode de pression, celà permet de récupérer le maximum des ingrédients du fruit et légume à la différence des presses fruits traditionnels  
 Ultra silencieux. Grace à son moteur à basse tours  
 Blocage de sortie  
 Capuchon à jus permettant de mélanger les fruits et légumes à l'intérieur du récipient avant de les verser dans les pichets  
 Presse les fruits et légumes entiers  
 Introduire entièrement les fruits et légumes, gain de temps  
 Facile à nettoyer. Brosse fournit. Accessoires compatibles lave vaisselle



Mit „SLOW“-Technologie. Dank langsamer Rotation und Kaltpressung ermöglicht dieses System im Gegensatz zu herkömmlichen Saftpresen alle Nährstoffe aus Früchten und Gemüse zu erhalten  
 Sehr leise dank Motor mit niedriger Drehzahl  
 Spritzschutz  
 Mixt Obst und Gemüse im Innern des Behälters, bevor sie in den Krug gelangen  
 Entsaftet Obst und Gemüse am Stück  
 Kann Zutaten als ganzes verarbeiten und spart dadurch Zeit bei der Entsaftung  
 Einfache Reinigung. Bürste zur Innenreinigung Waschmaschinen taugliches Zubehör



"SLOW" Rotation Engine . The slow rotation system facilitates a cold squeeze that allows the juice preserve all the nutritional properties from vegetables and fruits, unlike traditional squeezers  
 Ultra-silent. It's engine works in silence and eliminates unnecessary noise  
 Juice stopper  
 Mixes all the desired fruits and vegetables inside the container before serving  
 Whole Fruit  
 The slow juicer lets you work with whole fruits and big pieces of vegetables  
 Easy cleaning. A brush incorporated for the inner parts. All pieces are dishwasher compatible

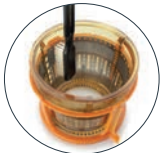

Tecnologia "SLOW". O sistema de rotação lenta e o método de prensagem a frio permitem obter todos os nutrientes das frutas e das verduras, ao contrário do que acontece com os espremedores tradicionais  
 Ultra-silencioso, graças ao seu motor de baixas rotações  
 Bloqueio da saída  
 Mistura frutas e verduras no interior do recipiente antes de os verter no jarro  
 Espreme as frutas e as verduras inteiras  
 Permite introduzir os ingredientes inteiros, reduzindo assim o tempo dedicado à extração do sumo  
 Fácil de limpar. Escova para limpeza das partes internas. Acessórios aptos para a máquina de lavar louça

Incluye Recetario  
 Recipe Book included  
 #lalakitchen





## Personal Blender

· Household use ·



**Ideal para preparar pequeñas cantidades de cremas, batidos y zumos de fruta y verdura al instante. Compactas y de gran potencia ( 350 W), disponen de 4 cuchillas de acero inoxidable especiales para triturar hielo y moler semillas, frutos secos, cereales y café. Permiten preparar y transportarlo en el mismo recipiente gracias a su jarra-vaso portátil (de tritán) y cierre hermético.**

**Como complemento, puedes adquirir la funda de neopreno ( 600 ml) negra para mantener las bebidas frías más tiempo.**

Idéal pour préparer instantanément de petites quantités de crèmes, milk-shakes et jus de fruits et légumes. Compact et d'une grande puissance (350 W), il dispose de 4 lames en acier inoxydable spéciales pour piler la glace et moulin les graines, les fruits secs, les céréales et le café. Permet de préparer et de transporter les préparations dans le même récipient grâce à son pichet/verre portable (en tritan) et sa fermeture hermétique. Vous pouvez acheter, en tant qu'accessoire, la housse en néoprène (600 ml) noire pour conserver les boissons froides plus longtemps

Ideal für die schnelle Zubereitung von Cremes, Shakes und Säften aus Obst und Gemüse in kleinen Mengen. Platzsparend und leistungsstark (350W) mit 4 rostfreien Spezialmessern zum Zerkleinern von Eis und Mahlen von Samen, Trockenobst, Getreide und Kaffee. Zubereitung und Transport im selben Behälter, dank tragbarem und dicht verschließbarem Glaskrug (aus Tritan).

Schwarze Neoprenhülle (600ml) als Zubehör erhältlich, um die Getränke länger kühl zu halten.

Ideal for preparing small quantities of creams, smoothies and fruit and vegetable juices instantly. Compact and powerful (350 W), it has 4 special stainless steel blades for crushing ice and grinding seeds, nuts, cereals and coffee. Enables you to prepare and transport your juices or smoothies in the same container thanks to its portable bottle-cup (Tritan) with airtight seal. As an accessory, you can purchase the black neoprene sleeve (600 ml) to keep drinks cooler for longer

Ideal para preparar pequenas quantidades de cremes, batidos e sumos de frutas e verduras num instante. Compactas e potentes (350 W), com 4 lâminas de aço inoxidável especiais para triturar gelo e moer sementes, frutos secos, cereais e café. Permite preparar e transportar os alimentos processados no mesmo recipiente, graças ao seu jarro-vaso portátil (de tritan) com fecho hermético.

Como complemento, também pode adquirir a capa de neopreno (600 ml) preta para manter as bebidas frias durante mais tempo.



### Batidora personal FRESH & GO

Personnelle mixeur  
Personliche mixer  
Personal blender  
Misturador pessoal

Ref	€	Pack
69381	44,90	1



### Batidora personal MIX & GO

Personnelle mixeur  
Personliche mixer  
Personal blender  
Misturador pessoal

Ref	€	Pack
69382	39,50	1

Ref	Tensión/Voltage	Potencia/Power	Capacidad/Capacity	Dimensiones/Sizes	Peso/Weight
69381	220-240 V / 50 Hz	350 W	600 ml	13x13x36 cm	1,10 Kg
69382	220-240 V / 50-60 Hz	350 W	600 ml / 300 ml	12x12x40,5 cm	1,05 Kg



**Tapa con boquilla (69381) y tapa con boquilla y clip (69382) para transportar**  
**Cuchillas de acero inoxidable especiales para triturar hielo y moler semillas, frutos secos, cereales y café**  
**Jarra portátil 600 ml (69381) y dos jarras portátiles de 600-300 ml (69382) de trítan, material libre de BPA**  
**Fácil de desmontar y limpiar**

Couvercle avec bec (69381) et couvercle avec bec et clipser (69382) pour transporter  
 Lames en acier inoxydable spéciales pour piler la glace et pour broyer des graines, des fruits secs, des céréales et du café  
 Vas détachable 600 ml (69381) et deux vases détachables de 600 et 300 ml (69382) en tritan, matériau sans BPA  
 Facile à démonter et à nettoyer



Deckel mit Mundstück (69381) und deckel mit Mundstück und clip (69382) zu transportieren  
 Spezialmesser aus rostfreiem Stahl zum Zerkleinern von Eis und zum Samen, Nüsse, Getreide und Kaffee malen  
 Tragbare Kannen 600 ml (69381) und Zwei tragbare Kannen für 600-300 ml (69382) aus Tritan, einem BPA-freiem Material  
 Einfach zu demontieren und zu reinigen



Lid with spout (69381) and lid with spout and clip (69382) to transport  
 Special stainless steel blades for crushing ice and grind seeds, nuts, cereals and coffee  
 Portable bottle (69381) and two portable bottles (600ml and 300ml) (69382) made from Tritan, a BPA-free material  
 Easy to disassemble and clean



Tampa com bico (69381) e tampa com bico e clipe (69382) para transportar  
 Lâminas de aço inoxidável especiais para triturar gelo e moer sementes, frutos secos, cereais e café  
 Jarra portáteis de 600 ml (69382) e duas jarras portáteis de 600 e 300 ml (69382) de Tritan, um material que não contém BPA  
 Fácil de desmontar e limpar



## Accesorio

Accessoire · Zubehör · Accessorie · Acessório

**New**

*Impermeable*  
 Imperméable · Wasserdicht  
 Waterproof · Impermeável



**Funda Neopreno**  
 manchon Neoprene  
 neopren Hülle  
 Neoprene sleeve  
 Luva de Neoprene

Ref	€	Pack
R69382F	2,40	1

**Ideal para proteger la bebida frente a los rayos ultravioleta**  
**Ayuda a mantener la temperatura durante un tiempo más prolongado**  
**Agradable al tacto**  
**Actúa como protector frente a posibles caídas**

Parfait pour protéger la boisson des rayons ultraviolets  
 Aide à maintenir la température pendant un laps de temps plus long  
 Agréable au toucher  
 Agit comme une protection face aux éventuelles chutes

Zum Schutz des Getränks vor UV-Strahlung geeignet  
 Bewahrt die Temperatur länger  
 Angenehm anzugreifen  
 Wirkt als Schutz bei Herunterfallen

Ideal for protecting drinks from ultraviolet rays  
 Helps to maintain the temperature for a longer time  
 Pleasant to touch  
 Acts as a protector against possible falls

Válida para proteger a bebida dos raios ultravioleta  
 Mantém a temperatura da bebida durante mais tempo  
 Agradável ao tato  
 Protege o recipiente em caso de queda

## Batidoras Profesionales BLACK & WHITE

· Professional use ·

Incluye Recetario  
Inclus livre de recettes  
Recipe Book included

· Mi taller de Bienestar ·  
Lauri Bengochea



### Potencia y resultados profesionales

Disfruta del placer de cocinar con la Batidora Profesional Gracias a su gran rendimiento, potente motor, calidad y durabilidad lograrás resultados extraordinarios

La batidora ofrece una gran versatilidad y es ideal para elaborar todo tipo de zumos, batidos, sopas, salsas, patés, granizados, helados etc.

Incluye un completo recetario con todo tipo de recetas diseñado por Lauri Bengochea ([www.mitallerdebienestar.com](http://www.mitallerdebienestar.com)) en exclusiva para Lacor

### Performance et résultats professionnels

Cuisinez avec plaisir grâce au Blender Professionnel. Sa performance, son puissant moteur, sa qualité et durée de vie vous donneront des résultats extraordinaires. Le blender offre une grande flexibilité et est idéal pour élaborer tout type de jus, smoothies, soupes, sauces, pâtés, granizado (boissons rafraîchissantes), glaces, etc. Il contient un livre de recettes élaboré par Lauri Bengochea ([www.mitallerdebienestar.com](http://www.mitallerdebienestar.com)) en exclusivité pour Lacor

### Meisterliche Leistung und Ergebnisse

Mit diesem Profi-Mixer macht Kochen Spaß. Dank seiner Ergiebigkeit, Power, Qualität und Langlebigkeit gelingt alles bestens.

Der Mixer ist sehr vielseitig und eignet sich perfekt zum Bereiten von Säften, Shakes, Suppen, Saucen, Pasteten, Slush, Eis usw.

Samt Rezeptheft von Lauri Bengochea mit vielen leckeren Rezeptideen ([www.mitallerdebienestar.com](http://www.mitallerdebienestar.com)) - speziell für Lacor

### Power and Professional Results

Enjoy the pleasure of cooking with the Professional Mixer Thanks to its high performance, powerful motor, quality and durability you'll get extraordinary results

The mixer is extremely versatile and perfect for making all kinds of juices, shakes, soups, sauces, pâtés, iced drinks, ice cream and more It comes with a complete cookbook with all kinds of recipes designed exclusively for Lacor by Laura Bengochea ([www.mitallerdebienestar.com](http://www.mitallerdebienestar.com))

### Potência e resultados profissionais

Desfruta do prazer de cozinhar com a Batedeira Profissional De grande qualidade e durabilidade, o seu grande rendimento e o seu potente motor permitir-te-ão alcançar resultados extraordinários

De grande versatilidade, a batedeira é ideal para elaborar todo o tipo de sumos, batidos, sopas, molhos, patés, granizados, gelados, etc.

Inclui um completo livro com todo o tipo de receitas, da autoria de Lauri Bengochea ([www.mitallerdebienestar.com](http://www.mitallerdebienestar.com)) criado em exclusivo para Lacor



**New**

### Batidora eléctrica Profesional BLACK

Batteur électrique Professionnel  
Elektrischer Profi-Mixer  
Professional electric blender  
Batedor eléctrico Profissional

Ref	€	Pack
69195	390,10	1

### Batidora eléctrica Profesional WHITE

Batteur électrique Professionnel  
Elektrischer Profi-Mixer  
Professional electric blender  
Batedor eléctrico Profissional

Ref	€	Pack
69295	337,50	1

Ref	Tensión/Voltage	Potencia/Power	Velocidad/Speed	Capacidad/Capacity	Dimensiones/Sizes	Peso/Weight
69195	220-240 V / 50-60 Hz	3 HP = 2250 W	38.000 r.p.m	2,0 L	28x26x52 cm	5,00 Kg
69295	220-240 V / 50-60 Hz	950 W	13.000 - 38.000 r.p.m	1,5 L	18x24x42 cm	4,00 Kg



**Resultados profesionales · Résultats professionnels · Professional results**

Gran rendimiento, versatilidad y durabilidad · Grand rendement, versatilité et durabilité · Great performance, versatility and durability



**Accesorios**

Accessoires · Zubehör · Accessories · Acessórios

**New**



**Apta para las batidoras 69195 y 69295**

Apte pour les mixeurs 69195 et 69295  
Geeignet für die Mixer 69195 und 19295  
Apt for blenders 69195 and 69295  
Apta para as bateadeiras 69195 e 69295

**Jarra batidora con cuchillas**

Pot batteur avec lamestl  
Krug mit schneider für mixergerät  
Blender jug with blades  
Jarra batidora com lâminas

Ref	€	L	Pack
R69195N	153,10	2,0	1



**Apta para las batidoras 69195 y 69295**

Apte pour les mixeurs 69195 et 69295  
Geeignet für die Mixer 69195 und 19295  
Apt for blenders 69195 and 69295  
Apta para as bateadeiras 69195 e 69295

**Jarra batidora con cuchillas**

Pot batteur avec lamestl  
Krug mit schneider für mixergerät  
Blender jug with blades  
Jarra batidora com lâminas

Ref	€	L	Pack
R69295A	151,00	1,5	1



**Aísla y reduce el nivel de ruido un 80%**

Isole et réduit le niveau de bruit de 80%  
Isoliert und reduziert den Geräuschpegel um 80%  
Isolates and reduces the noise level by 80%  
Isola e reduz em 80% o nível de ruído

**Carcasa aislante de ruido**

Boîtier isolant du bruit  
Geräuschdämpfendes Gehäuse  
Noise reducing enclosure  
Carcaça isolante do ruído

Ref	€	cm	h (cm)	Pack
R69295B	196,10	25x30	46	1



**New**

PC  
polycarbonato

**NOTA**

La carcasa solo es valida si las batidoras llevan la jarra baja, NUNCA con la jarra alta

**REMARQUE**

La carcasse n'est valable que si les mixeurs possèdent un bol bas, JAMAIS avec un bol haut

**ANMERKUNG**

Das Gehäuse kann nur verwendet werden, wenn die Mixer mit einem niedrigen Krug ausgestattet sind, KEINESFALLS mit dem hohen Krug verwenden

**NOTE**

The casing is only valid if the blender comes with a lower recipient, NEVER for a higher recipient

**NOTA**

A carcaça só é utilizável se as bateadeiras utilizam o jarro baixo. NUNCA utilizar se a bateadeira utiliza o jarro alto



## Batidoras

• Semiprofessional use •

• Household use •



### Batidora eléctrica

Batteur électrique  
Elektrischen Mixer  
Electric blender  
Batedor eléctrico

Ref	€	Pack
69194	148,90	1



### Batidor con jarra de cristal

Mixer avec jarre en verre  
Mixer mit Glaskrug  
Blender with glass jug  
Batedor com jarra de vidro

Ref	€	Pack
69081	67,50	1

Ref	Tensión/Voltage	Potencia/Power	Velocidad/Speed	Capacidad/Capacity	Dimensiones/Sizes	Peso/Weight
69194	220-240 V / 50-60 Hz	750 W	20.500 r.p.m.	1,50 L	19,5x21x41 cm	4,25 Kg
69081	220-240 V / 50-60 Hz	500 W	10.000 - 12.000 r.p.m.	1,50 L	18x26x52 cm	5,00 Kg

• Household use •



### Batidora para sopa

Blender chauffeur  
Suppenhersteller  
Soup maker  
Máquina a sopa

Ref	€	Pack
69380	173,60	1

**Cocine sopas caseras, salsas, purés, cremas, batidos, zumos, cócteles, etc..**  
**Saltear ingredientes, cocinar a fuego lento o hervir sopas**  
**Mezcla los ingredientes durante el proceso de cocción**  
**Pica hielo en menos de 50 segundos y mezcla desde batidos hasta cócteles congelados**

Cuisinez des soupes maison, des sauces, des purées, des crèmes, des milk-shakes, des jus de fruit, des cocktails, etc  
Sauter les ingrédients, cuisiner à feu doux ou faire bouillir des soupes  
Mélange les ingrédients pendant le processus de cuisson  
Pile la glace en moins de 50 secondes et mélange aussi bien des milk-shakes que des cocktails congelés

Bereiten Sie hausgemachte Suppen, Püree, Cremes, Shakes, Säfte, Cocktails usw. zu Anbraten von Zutaten, langsamen Kochen oder Brühen von Suppen. Die Zutaten werden während des Kochvorgangs gemischt  
Eis wird in unter 50 Sekunden zerkleinert und es werden Shakes und sogar gefrorene Cocktails gemischt

Prepare home-made soups, sauces, purées, creams, milkshakes, juices, cocktails, etc. Sautéing ingredients, cooking at low heat or boiling soups. Mixes the ingredients during the cooking process  
Crushes ice in under 50 seconds and mixes anything from milkshakes to frozen cocktails

Elabore sopas caseiras, molhos, purés, cremas, batidos, sumos, cocktails, etc. Saltear ingredientes, cozinhar a fogo lento ou ferver sopas  
Misturando os ingredientes durante o processo de cocção  
Pica gelo em menos de 50 segundos, e mistura desde batidos até cocktails congelados

Ref	Tensión/Voltage	Pot.motor/Motor power	Calentamiento/Heating	Velocidad/Speed	Capacidad/Capacity	Dimensiones/Sizes	Peso/Weight
69380	220-240 V / 50-60 Hz	450 W	700 - 900 W	4	1,70 L	25x21x45 cm	2,40 Kg

## Licudadora

· Household use ·



Frutas y verduras enteras gracias a su orificio de entrada XL (75 mm)  
Add whole fruits and vegetables thanks to the extra large opening (75 mm)



**Tube de entrada XL para introducir frutas y verduras enteras**  
**Obtenga zumo de frutas y verduras manteniendo sus propiedades íntegras**  
**Los residuos son recogidos automáticamente en el recipiente, sujeto por un soporte**

Tube d'entrée XL pour introduire fruits et de légumes  
Obtenir des jus de fruits et de légumes en conservant leurs qualités intactes  
Les déchets sont automatiquement recueillis dans le récipient annexe est tenu par un support

XL-Aufgaberohr können ganze Äpfel und große Frucht- oder Gemüsestücke eingeführt werden  
Obst- und Gemüsesäfte unter Erhalt der wertvollen Inhaltsstoffe zubereiten  
Die Reste werden automatisch im Zusatzbehälter aufgefangen die durch einen Träger, der einen Sturz verhindert

XL inlet tube for introduce fruit and vegetables  
Obtain juices from fruits and vegetables maintaining all their properties  
The residues are automatically collected in the additional recipient, held by a support

Tube de entrada XL para introducir grandes pedaços de frutas e verduras  
Obter sumos de frutas e verduras mantendo as suas propriedades inalteradas  
Os resíduos passam automaticamente para o recipiente adicional, realizada por um suporte



### Licudadora de fruta

Fruit centrifugeuse  
Zitrus entsafter  
Juice extractor  
Liquidificador de sumos

Ref	€	Pack
69288	78,10	1

Ref	Tensión/Voltage	Potencia/Power	Capacidad/Capacity	Dimensiones/Sizes	Peso/Weight
69288	220-240 V / 50-60 Hz	850W	1,00 L	30x20x36 cm	4,10 Kg

## Máquinas de vacío

### ¿Qué es la cocción al vacío?

#### Beneficios de la cocción a baja temperatura:

Entre las nuevas técnicas de restauración, la más importante es la cocción y conservación al vacío. Las ventajas que ofrece esta técnica aseguran su introducción y adaptación a las necesidades de cada cocina: ganar tiempo, mejora de costes, mejor organización del personal y mayor duración de los productos, manteniendo sus cualidades higiénicas y organolépticas, son algunas de las principales razones que auguran su éxito e introducción en la Restauración.

Hablamos de productos sometidos a un proceso de envasado al vacío y expuestos a temperaturas que nunca superan los 100°C. Debido a la diferencia de presión, conseguimos temperaturas de ebullición del agua a baja temperatura y la penetración de temperatura a corazón de producto es lineal, es decir, no encuentra moléculas de aire y no produce una reacción radial, por lo que el tratamiento y los resultados obtenidos con el producto están perfectamente controlados.

La forma más sencilla de explicar la cocción al vacío es decir que en vez de guisar, como es tradicional, los alimentos a 130°C de calor por un periodo relativamente corto, aquí se cocuen entre 65°C y 99°C en tiempos más prologados según la naturaleza del género y su peso. Es, pues, una cocción larga y a baja temperatura. En un horno convencional, una pieza de carne se cuece a 200°C de temperatura, lo que ocasiona que el exterior se tueste. Sin embargo, la temperatura en el corazón de la pieza rara vez supera los 50°C. Por lo tanto, sólo es necesaria una temperatura igual o ligeramente superior a los 65°C para cocer un alimento, evitando el resecamiento y el endurecimiento de la fibra muscular así como la sobrecocción.

### Qu'est-ce que la cuisson sous-vide ?

#### Avantages de la cuisson à basse température :

Parmi les nouvelles techniques de restauration, la plus importante est la cuisson et la conservation sous-vide. Les avantages qu'offre cette technique garantissent son introduction et son adaptation aux besoins de chaque cuisine : gagner du temps, améliorer les coûts, une meilleure organisation du personnel et une plus grande durée de conservation des produits, en maintenant leur qualités hygiéniques et organoleptiques, sont quelques-unes des raisons principales qui expliquent son succès et son introduction dans la restauration.

Nous parlons de produits soumis à un processus de conditionnement sous-vide et exposés à des températures toujours inférieures à 100°C. En raison de la différence de pression, on obtient des températures d'ébullition de l'eau à basse température et la pénétration de la température au cœur du produit est linéaire, c'est-à-dire qu'elle ne rencontre pas de molécules d'air et ne produit aucune réaction radiale, c'est pourquoi le traitement et les résultats obtenus avec le produit sont parfaitement contrôlés.

La façon la plus simple d'expliquer la cuisson sous-vide est de dire qu'au lieu de cuisiner, comme c'est le cas traditionnellement, les aliments à une température de 130°C pendant un laps de temps relativement court, ils sont ici cuits entre 65°C et 99°C pendant un laps de temps plus long selon la nature du genre et le poids. Il s'agit donc d'une cuisson longue et à basse température. Dans un four conventionnel, une pièce de viande est cuite à une température de 200°C, ce qui provoque le brunissage de l'extérieur. Cependant, la température au cœur de la pièce dépasse rarement 50°C. Par conséquent, il suffit d'une température égale ou légèrement supérieure à 65°C pour cuire un aliment, évitant ainsi le dessèchement et le durcissement de la fibre musculaire ainsi que la surcuisson.

### What is Sous Vide?







#### The benefits of low-temperature cooking

Among the new techniques for cooking professionals, the most important one is cooking and storing food in vacuum sealed pouches. The advantages of the technique mean it will be used in and adapted to the needs of every kitchen. Some of the main reasons why it will be successful and widely used in the hospitality industry are the savings in time and money, better staff organisation and being able to store products longer without sacrificing organoleptic qualities or hygiene.

Sous vide refers to products that are vacuum sealed and never exposed to temperatures above 100°C. Because of the difference in pressure, water boils at a low temperature and heat penetrates into the heart of the product in a linear fashion which means there is no interference from air molecules and a radial reaction does not occur so consequently product manipulation and results can be perfectly controlled.

The simplest way to explain sous vide is to say that instead of the traditional method of cooking food at 130°C for a relatively short time food is cooked at 65°C to 99°C for a longer time, depending on the type of product and how much it weighs. It's essentially slow cooking at a low temperature. In a conventional oven, a piece of meat is cooked at 200°C, which makes the outside brown and crispy. However, the temperature in the centre rarely exceeds 50°C. So you can see that meat only needs to be cooked at 65°C or a little hotter, which prevents it from drying out or getting tough as well as over cooking.

### Tabla orientativa · Tableau d'orientation · Guidance table

Almacén Storehouse	25°C +/- 2°C									
<b>Almacenamiento normal</b> Normal storage life					1-2 semanas 1-2 weeks	3-4 días 3-4 days	2-4 días 2-4 days	1 semana 1 week	5-6 meses 5-6 months	
<b>Sellado al vacío</b> Vacuum sealed life					2-4 semanas 2-4 weeks	2 semanas 2 weeks	2 semanas 2 weeks	2-4 semanas 2-4 weeks	1 año 1 year	
<b>Frigorífico</b> Fridge	5°C +/- 2°C									
<b>Almacenamiento normal</b> Normal storage life		1-2 semanas 1-2 weeks	1 semana 1 week	1 semana 1 week	3-4 días 3-4 days	2-4 semanas 2-4 weeks	1-2 semanas 1-2 weeks	1-2 semanas 1-2 weeks	1-2 semanas 1-2 weeks	2-3 días 2-3 days
<b>Sellado al vacío</b> Vacuum sealed life		1 mes 1 month	2-4 semanas 2-4 weeks	2-4 semanas 2-4 weeks	2 semanas 2 weeks	1 mes 1 month	1 mes 1 month	6-12 semanas 6-12 weeks	6-12 semanas 6-12 weeks	1 semana 1 week
<b>Congelador</b> Freezer	-18°C +/- 2°C									
<b>Almacenamiento normal</b> Normal storage life		6 meses 6 months	6 meses 6 months	6 meses 6 months	1-2 semanas 1-2 weeks	8 meses 8 months	8 meses 8 months	6-12 semanas 6-12 weeks	4 meses 4 months	
<b>Sellado al vacío</b> Vacuum sealed life		2-3 años 2-3 years	2-3 años 2-3 years	2-3 años 2-3 years	2 años 2 years	2-3 años 2-3 years	2-3 años 2-3 years	6 meses 6 months	1 año 1 year	

• Professional use •

Altura interior útil  
Hauteur intérieure utile  
nützlich Innenhöhe  
Useful interior height  
altura interior útil

11 cm



**Admite la aspiración de líquidos y salsas, sin necesidad de congelarlos antes Envasado por mediación de un COMPRESOR DE AIRE. Compresor con pistón, dispone de válvula de entrada y salida de aire AI no ser aceite no suele precisar mantenimiento alguno**

Permet l'aspiration de liquides et de sauces, sans avoir à les congeler auparavant Mise sous vide au moyen d'un COMPRESSEUR D'AIR. Compresseur avec piston, dispose de valve d'entrée et de sortie d'air Dans la mesure où il n'y a pas d'huile, aucun entretien n'est nécessaire

Ermöglicht das Ansaugen von Flüssigkeiten und Soßen ohne vorheriges Gefrieren in die Verpackung Abfüllung mit Hilfe eines DRUCKLUFTKOMPRESSORS. Kolbenkompressor mit Druckluftein- und -ausgangsventil Da kein Öl komprimiert wird, ist normalerweise keine Wartung erforderlich

Enables liquids and sauces to be aspirated in the bag with no need to freeze them first Packaging using an AIR COMPRESSOR. Compressor with piston, has an air inlet/outlet valve As it is not oil-based, no maintenance is required

Admite a aspiração de líquidos e de molhos, sem necessidade de os congelar previamente Embalagem por meio de um COMPRESSOR DE AR. O compressor de pistão dispõe de válvula de entrada e saída de ar Ao não utilizar óleo, não querer qualquer tipo de manutenção

**Máquina de vacío campana**

Machine sous vide à cloche  
Vakuuiergeräte  
Bell-shaped vacuum machine  
Máquina de vacío tipo câmara

Ref	€	Pack
69116	1.389,50	1

Ref	Tensión/Voltage	Potencia/Power	Vacío/Vacuum	Caudal bomba/Pump flow	L. sellado/Seal length	A. sellado/Seal width	Dimensiones/Sizes	Peso/Weight
69116	220-240 V / 50-60 Hz	630 W	0,9 bar	5 m³/h	29 cm	4 cm	42x36x36,5 cm 35x30x5 cm (cámara - chamber)	24,5 Kg

• Professional use •



**Posibilidad de realización de bolsas (Rollo incluido) Admite la aspiración de líquidos y salsas, sin necesidad de congelarlos antes Envasado por mediación de un COMPRESOR DE AIRE. Compresor con pistón, dispone de válvula de entrada y salida de aire**

Possibilité de réalisation de sachets (Rouleau inclus) Permet l'aspiration de liquides et de sauces, sans avoir à les congeler auparavant Mise sous vide au moyen d'un COMPRESSEUR D'AIR. Compresseur avec piston, dispose de valve d'entrée et de sortie d'air

Option zur Erstellung von Beutel (Rolle enthalten) Ermöglicht das Ansaugen von Flüssigkeiten und Soßen ohne vorheriges Gefrieren in die Verpackung Abfüllung mit Hilfe eines DRUCKLUFTKOMPRESSORS. Kolbenkompressor mit Druckluftein- und -ausgangsventil

Possibility of making bags (Roll included) Enables liquids and sauces to be aspirated in the bag with no need to freeze them first Packaging using an AIR COMPRESSOR. Compressor with piston, has an air inlet/outlet valve

Possibilidade de confeccionar sacos (Rolo incluído) Admite a aspiração de líquidos e de molhos, sem necessidade de os congelar previamente Embalagem por meio de um COMPRESSOR DE AR. O compressor de pistão dispõe de válvula de entrada e saída de ar

**Máquina de vacío campana**

Machine sous vide à cloche  
Vakuuiergeräte  
Bell-shaped vacuum machine  
Máquina de vacío tipo câmara

Ref	€	Pack
69352	790,20	1

Ref	Tensión/Voltage	Potencia/Power	Vacío/Vacuum	Caudal bomba/Pump flow	L. sellado/Seal length	A. sellado/Seal width	Dimensiones/Sizes	Peso/Weight
69352	220-240 V / 50 Hz	350 W	0,9 bar	60 L/min	30 cm	2,5 cm	42x38x27 cm 30,5x32,2x8 cm (cámara - chamber)	10 Kg



• Semiprofessional use •



**Barra de sellado de 32 cm**  
**Fácil extracción de tapa para su limpieza**  
**Bandeja de líquidos extraíble y apta para el lavavajillas**

Barre de soudure 32 cm  
 Couvercle à extraction facile pour son nettoyage  
 Plateau de liquides extractible et compatible avec le lave-vaisselle

Siegelschiene 32 cm  
 Leichte Entnahme des Deckels zu Reinigungszwecken  
 Herausnehmbares, waschmaschinenfestes Auffangblech für Flüssigkeiten

Seal bar 32 cm  
 Easy removal of the cover for cleaning  
 Removable and dishwasher-safe liquid tray

Barra de selagem 32 cm  
 Tapa de fácil extração para a sua limpeza  
 Bandeja de líquidos extraível e apta para a máquina de lavar louça

**Máquina de vacío PROFESIONAL**

Machine sous vide PROFESSIONNELLE  
 PROFI-Vakuumiergerät  
 PROFESSION vacuum machine  
 Máquina de vacío PROFESIONAL

Ref	€	Pack
69430	700,40	1

Ref	Tensión/Voltage	Potencia/Power	Vacío/Vacuum	Caudal bomba/Pump flow	L. sellado/Seal length	A. sellado/Seal width	Dimensiones/Sizes	Peso/Weight
69430	220-240 V / 50-60 Hz	130 W	0,9 bar	18 L/min	32 cm	3 mm	40,5x24,5x13 cm	5,20 Kg

• Household use •



**Máquina de vacío HOME**

Machine sous vide HOME  
 HOME-Vakuumiergerät  
 HOME Vacuum Pack machine  
 Máquina de vacío HOME

Ref	€	Pack
69050	88,60	4

*Incluye 10 bolsas de vacío (20x30 cm)*

Comprend 10 sacs sous vide - 20x30 cm.  
 Enthält 10 Vakuumbbeutel - 20x30 cm.  
 Includes 10 vacuum bags - 20x30 cm.  
 inclui 10 sacos de vacío - 20x30 cm.

**Función canister, vacío en botes (NO incluidos)**

Fonction Canister, mise sous vide en bocaux (NON inclus)

Kannisterfunktion, Vakuumerzeugung in Dosen (NICHT enthalten)

Canister function, empty in cans (NOT included)

Função de canister, para criar vácuo em frascos (NÃO incluídos)



**Máquina de vacío LUXE**

Machine sous vide LUXE  
 LUXE-Vakuumiergerät  
 LUXE Vacuum Pack machine  
 Máquina de vacío LUXE

Ref	€	Pack
69151	99,90	4

*Incluye 10 bolsas de vacío*

*(5 de 20x30 cm y 5 de 28x40 cm)*

Comprend 10 sacs sous vide - 20x30 cm (5) / 28x40 cm (5)  
 Enthält 10 Vakuumbbeutel - 20x30 cm (5) / 28x40 cm (5)  
 Includes 10 vacuum bags - 20x30 cm (5) / 28x40 cm (5)  
 inclui 10 sacos de vacío - 20x30 cm (5) / 28x40 cm (5)

Ref	Tensión/Voltage	Potencia/Power	Vacío/Vacuum	Caudal bomba/Pump flow	A. sellado/Seal width	Dimensiones/Sizes	Peso/Weight
69050	220-240 V / 50 Hz	110 W	0,8 bar	9 l/min	280 mm (max)	36x15x5,5 cm	1,40 Kg
69151	220-240 V / 50 Hz	120 W	0,6 - 0,8 bar	9 l/min	300 mm (max)	37x15x8 cm	1,55 Kg

• Household use •



**Possibilidade de realização de bolsas (Rolo incluído)**  
**Función canister, vacío en botes (NO incluídos)**

Possibilité de réalisation de sachets (rouleau inclus)  
 Fonction Canister, mise sous vide en bocaux (NON inclus)

Option zur Erstellung von Beutel (Rolle enthalten)  
 Kannisterfunktion, Vakuumerzeugung in Dosen (NICHT enthalten)

Possibility of making bags (Roll included)  
 Canister function, empty in cans (NOT included)

Possibilidade de confeccionar sacos (Rolo incluído)  
 Função de canister, para criar vácuo em frascos (NÃO incluídos)

**Máquina de vacío MAXI**

Machine sous vide  
 Vakuumiergerät  
 Vacuum pack machine  
 Máquina de vacío

Ref	€	Pack
69350	122,60	1

Ref	Tensión/Voltage	Potencia/Power	Vacío/Vacuum	Caudal bomba/Pump flow	L. sellado/Seal length	A. sellado/Seal width	Dimensiones/Sizes	Peso/Weight
69350	220-240 V / 50-60 Hz	110 W	0,6 - 0,8 bar	12 l/min	30 cm	3 mm	43,5x21x10 cm	2,05 Kg

• Household use •



Incluye 5 bolsas de vacío  
 Comprend 5 sacs sous vide  
 Enthält 5 Vakuumbeutel  
 Includes 5 vacuum bags  
 inclui 5 sacos de vacío



**Diseño compacto y ergonómico, perfecta para uso doméstico**  
**Conserva los alimentos frescos mucho más tiempo conservando intactas todas las propiedades**  
**Realiza el proceso de vaciado tan solo apretando un extremo de la máquina**  
**Sellado completamente automática con tan solo pulsando un botón**  
**Incorpora led que indica la situación del proceso de envasado en todo momento**

Design compact et ergonomique, parfaite pour un usage domestique  
 Maintient les aliments frais beaucoup plus longtemps, conservant intactes toutes leurs propriétés  
 Réalise le processus de conditionnement sous vide en appuyant simplement à une extrémité de la machine  
 Scellage entièrement automatique en appuyant simplement sur un bouton  
 Intègre un signal lumineux à led qui indique à tout moment la situation du processus de conditionnement sous vide

Platzsparendes und ergonomisches Design, perfekt für den häuslichen Gebrauch  
 Hält Lebensmittel unverändert für sehr viel länger frisch  
 Vakuumiert mit einem Handgriff am Ende des Geräts  
 Verschweißt komplett automatisch auf einfachen Knopfdruck  
 LED-Anzeige zur Fortschrittskontrolle des Verpackungsvorgangs

Compact and ergonomic design, perfect for domestic use  
 Keeps food fresh for much longer by keeping its properties intact  
 Perform the vacuum process by simply pressing one end of the machine  
 Fully automatic sealing at the touch of a button  
 Incorporates an LED that shows the status of the packaging process at all times

Design compacto e ergonómico, perfeita para uso doméstico  
 Permite conservar os alimentos frescos durante muito mais tempo, conservando intactas as suas propriedades  
 Processo de formação de vácuo simples, bastando apertar uma das extremidades da máquina  
 Selagem completamente automática premindo um botão  
 Incorpora um indicador LED que indica a situação do processo de embalagem em todo o momento

**Máquina de vacío COMPACT**

Machine sous vide  
 Vakuumiergerät  
 Vacuum Pack machine  
 Máquina de vacío

Ref	€	Pack
69351	74,30	1



Ref	Tensión/Voltage	Potencia/Power	Vacío/Vacuum	Caudal bomba/Pump flow	Dimensiones/Sizes	Peso/Weight
69351	220-240 V / 50 Hz	140 W	0,4 - 0,6 bar	11 L/min	26x16x5,5 cm	0,840 Kg

• Household use •

*Conserva la calidad, frescor y sabor de los alimentos durante mucho más tiempo*

Conserve la qualité, la fraîcheur et la saveur des aliments beaucoup plus longtemps  
Bewahrt Qualität, Frische und Geschmack der Nahrungsmittel über eine wesentlich längere Zeit

Preserves the quality, freshness and taste of food for much longer  
Conserva a qualidade, a frescura e o sabor dos alimentos durante muito mais tempo



**El mejor sellado para alimentos tanto húmedos como secos**

Le meilleur scellage pour les aliments aussi bien humides que secs  
Die beste Versiegelung sowohl für feuchte als auch trockene Nahrungsmittel  
The best seal for both moist and dry food  
A melhor selagem para alimentos, húmidos e secos

**Compartimento para líquidos**

Compartment pour liquides  
Abteil für Flüssigkeiten  
Compartment for liquids  
Compartimento para líquidos

**Máquina de vacío EXTREME**

Machine de conditionnement sous vide  
Vakuumiergerät  
Vacuum machine  
Máquina de vacío

Ref	€	W	Pack
69355	119,50	110	1

**Sella herméticamente los alimentos aumentando de 3 a 5 veces más tiempo su durabilidad**  
**Expulsa el aire y la humedad, manteniendo sus sabores y nutrientes**  
**Panel de control táctil, 2 niveles de envasado al vacío: alimentos húmedos y secos**  
**Contiene un orificio para la aspiración de los botes**  
**Bandeja para recoger líquidos en la parte posterior de la máquina**  
**Gracias a su diseño vertical ocupa poco espacio**  
**Incluye: 5 bolsas de 20x30cm / Rollo 20cmx2m / Tubo canister de 40 cm de largo**

Scellage hermétique des aliments, augmentant ainsi de 3 à 5 fois leur durabilité. Expulse l'air et l'humidité, en conservant leurs saveurs et leurs nutriments. Tableau de contrôle tactile, 2 niveaux de conditionnement sous vide : aliments humides et aliments secs. Contient un orifice pour l'aspiration des pots. Plateau pour recueillir les liquides dans la partie arrière de la machine. Prend moins de place grâce à sa conception verticale. Inclut : 5 sachets de 20x30 cm / Rouleau 20 cmx2 m / Tube canister de 40 cm de longueur

Versiegelt die Nahrungsmittel luftdicht und verlängert deren Haltbarkeit um das 3- bis 5-fache. Es werden Luft und Feuchtigkeit abgeleitet und der Geschmack sowie die Nährstoffe bewahrt. Sensorbedienfeld, 2 Vakuumierstufen: feuchte und trockene Nahrungsmittel. Enthält eine Öffnung zum Absaugen der Dosen. Auffangwanne für Flüssigkeiten auf der Rückseite des Geräts. Dank des vertikalen Designs platzsparend. Enthält: 5 Beutel 20x30 cm / Rolle 20 cm x 2 m / Canister -Schlauch, 40 cm lang.

Hermetically seals the food, increasing its shelf life by 3 to 5 times  
Expels air and moisture, maintaining the food's flavours and nutrients  
Touch control panel, 2 levels of vacuum packaging: moist and dry foods  
Contains a hole for vacuum sealing canisters  
Liquid collection tray on the back of the machine  
Takes up little space thanks to its vertical design  
Includes: 5 20x30cm bags / 20cmx2m roll / 40 cm-long canister hose

Sela hermeticamente os alimentos, aumentando de 3 a 5 vezes a sua validade  
Expulsa o ar e a humidade, conservando os sabores e os nutrientes  
Painel de controlo tátil, 2 níveis de embalagem em vácuo: alimentos húmidos e secos  
Inclui um orifício para aspiração de frascos  
Bandeja para recolher líquidos na parte posterior da máquina  
O seu desenho vertical economiza espaço  
Inclui 5 sacos de 20 x 30 cm / Rolo de 20 cm x 2 m / Tubo canister de 40 cm de comprimento



Ref	Tensión/Voltage	Potencia/Power	Presión/Pressure	Cap. bomba/Pump Cap.	Sellado/Seal	Dimensiones/Sizes	Peso/Weight
69355	220-240 V / 50 Hz	450 W	0,8 bar	12 L/min	L=30 cm / W=2,5 mm	42x9,5x15 cm	1,70 Kg



## Bolsas · Bobinas · Botes vacío



Apto para uso alimenticio

Recomendada para uso con máquina de vacío de la marca LACOR

Soldadura longitudinal extrafuerte, 1 cm

No se recomienda su reutilización tras el uso con carnes, pescados y otros alimentos deteriorables, tan solo tras el uso en productos secos, legumbres, frutos secos, etc...

Adaptée au conditionnement de denrées alimentaires

Recommandée pour être utilisée avec la machine à emballer sous vide LACOR

Soudure longitudinale très résistante de 1 cm

Son utilisation est déconseillée pour reconditionner de la viande, du poisson et d'autres denrées alimentaires périssables

Elle peut être réutilisée pour reconditionner des fruits secs, des légumes, des fruits secs, etc.

Lebensmittelgeprüft

Empfohlen für den Einsatz mit Vakuumergerät der Marke LACOR

Extrastarke Längsverschweissung, 1 cm

Nicht empfohlen wird die Wiederverwendung nach Verwendung für Fleisch, Fisch und sonstigen verderblichen Lebensmitteln

Wiederverwendung nur nach Verwendung für trockene Produkte, Hülsenfrüchte, Trockenfrüchte etc.

Suitable for use with food

Recommended for use with vacuum packer of the LACOR brand

Extra strong lengthways sealing, 1 cm.

Not recommended to be reused after use with meats, fish and other fresh foods, only after use with dried products, pulses, nuts, etc.

Adequado para uso de alimentos

Recomendado para usar com máquina de vácuo do marca LACOR

Soldagem extra forte longitudinal, 1 cm

Não recomendado para reutilização após a utilização com carnes, peixes e outros alimentos perecíveis, somente após a utilização em produtos secos, legumes, nozes, etc....



### Bobina tubo vacío

Bobine de tube  
Vakuumbbeutel Rollen  
Coil tube  
Bobina manga

Ref	€	Bobina	Micras	Pack
69052	11,30	28cmx5m 22cmx5m	105	1
69057	7,70	14cmx10 m	105	1
69059	10,70	22cmx10m	105	1
69058	14,00	28cmx10m	105	1
69259	7,20	28cmx5m	105	1
69458	9,30	28cmx5m	90	1
69459	7,40	22cmx5m	90	1
69462	7,80	28cmx5m 22cmx5m	100	1
69463	6,90	22cmx10m	100	1
69464	8,70	28cmx10m	100	1

Lisas  
Flat



### Bolsas vacío

Sacs de conservation sous vide  
Vakuumbbeutel, 100 Stueck  
Vacuum bags  
Sacos de vácuo

Ref	€	Bolsa	Unidades	Micras	Pack
69053	4,00	16x20	25	105	1
69054	7,00	20x30	25	105	1
69055	9,50	24x36	25	105	1
69056	11,90	28x40	25	105	1
69042	26,00	20x30	100	105	1
69046	38,00	25x35	100	105	1
69047	51,80	30x40	100	105	1
69048	104,00	40x60	100	105	1
69453	4,80	16x20	25	90	1
69454	8,90	20x30	25	90	1
69455	12,50	24x36	25	90	1
69460	4,40	20x30	25	100	6
69461	8,20	28x40	25	100	6

Lisas  
Flat

### Set 3 botes vacío hogar + adaptador

3 boîte sous vide + Adaptateur  
3 Vakuumb-Behälter-Set + Adapter  
3 Shape canister set + Adapter  
Conj. 3 caixas vácuo domésticas + Adaptador

Ref	€	L	Pack
69051	29,30	0,7-1,4-2,0	1





Máquina de vacío / Vacuum pack machine

				69116	69352	69430	69050	69151	69350	69351	69355	
												
<b>ROLLO · COIL TUBE</b> 	69052	28cmx5m/22cmx5m	Gofrada	✓	✓	✓	✓	✓	✓		✓	
	69057	14cmx10m	Gofrada	✓	✓	✓	✓	✓		✓	✓	
	69059	22cmx10m	Gofrada	✓	✓	✓	✓	✓		✓	✓	
	69058	28cmx10m	Gofrada	✓	✓	✓	✓	✓			✓	
	69259	28cmx5m	Gofrada	✓	✓	✓	✓	✓	✓		✓	
	69458	28cmx5m	Gofrada	✓	✓	✓	✓	✓	✓		✓	
	69459	22cmx5m	Gofrada	✓	✓	✓	✓	✓	✓	✓	✓	
	69462	28cmx5m/22cmx5m	Lisa	✓	✓							
	69463	22cmx10m	Lisa	✓	✓							
69464	28cmx10m	Lisa	✓	✓								
<b>BOLSAS · BAGS</b> 	69053	16x20	Gofrada	✓	✓	✓	✓	✓	✓	✓	✓	
	69054	20x30	Gofrada	✓	✓	✓	✓	✓	✓	✓	✓	
	69055	24x36	Gofrada	✓	✓	✓	✓	✓	✓		✓	
	69056	28x40	Gofrada	✓	✓	✓	✓	✓	✓		✓	
	69042	20x30	Gofrada	✓	✓	✓	✓	✓	✓	✓	✓	
	69046	25x35	Gofrada	✓	✓	✓	✓	✓	✓		✓	
	69047	30x40	Gofrada		✓	✓		✓	✓		✓	
	69453	16x20	Gofrada	✓	✓	✓	✓	✓	✓	✓	✓	
	69454	20x30	Gofrada	✓	✓	✓	✓	✓	✓	✓	✓	
	69455	24x36	Gofrada	✓	✓	✓	✓	✓	✓		✓	
	69460	20x30	Lisa	✓	✓							
	69461	28x40	Lisa	✓	✓							
	69048(*)	40x60	Gofrada									

(\*) Apta para la máquina de vacío 69040 (descatalogada)

■ Bolsas y rollos para uso exclusivo del SOUS VIDE

## Sous Vide



### Técnica culinaria que prima la calidad del producto

**Resultados sorprendentes; alimentos más jugosos, tiernos y succulentos**

**Preserva las cualidades del producto y realiza su sabor y textura**

**La cocción se emplea introduciendo todos los ingredientes en una bolsa termo**

**sellada que se sumerge en agua caliente por debajo del punto de ebullición**

**Diseño compacto, anclaje sencillo y fácilmente almacenable y transportable**

**Incluye un completo y exclusivo recetario**

Technique culinaire qui privilégie la qualité du produit

Résultats surprenants ; aliments plus juteux, tendres et succulents

Préserve les qualités du produit et rehausse sa saveur et sa texture

La cuisson est réalisée en introduisant tous les ingrédients dans un sachet

thermo-scellé qui est immergé dans l'eau chaude en-dessous du point d'ébullition

Conception compacte, ancrage simple et facile à ranger et à transporter

Un exclusive et complet livre des recettes compris

Kochmethode zur Verfeinerung von Gargut

Lebensmittel sind erstaunlich saftig, zart und schmackhaft

Vorzüge der Lebensmittel bleiben erhalten und Geschmack und Textur werden verfeinert

Der Kochvorgang aller Zutaten erfolgt in Innern eines versiegelten Thermobeutels, der in heißes nicht-siedendes Wasser getaucht wird

Platzsparendes Design, leicht zu fixieren, gut verstau- und transportierbar

Samt vieler exklusiver Rezepte

Culinary technique that enhances the quality of the product

Amazing results; juicier, more tender and more succulent food

Preserves the qualities of the product and enhances its flavour and texture

Sous vide cooking works by putting all the ingredients in a heat-sealed bag which is submerged in hot water below the boiling point

Compact design, simple fastening and easy to store and transport

Exclusive and wide range of recipe book included

Técnica culinária que preserva a qualidade do produto

Resultados surpreendentes; alimentos mais ternos e succulentos

Preserva as qualidades do produto e realça o seu sabor e a sua textura

A cocção realiza-se introduzindo todos os ingredientes num saco térmico selado, que se submerge em água aquecida abaixo do ponto de ebulição

Desenho compacto, fixação simples e fácil de armazenar e de transportar

Inclui um completo e exclusivo livro de receitas

### Cocinando paso a paso...



#### Sazonamos los alimentos a cocinar

Assaisonner les aliments à cuisiner

Gargut würzen

Season the ingredients for cooking

Condimentamos os alimentos a cozinhar



#### Envasamos al vacío los alimentos

Conditionner les aliments sous vide

Gargut vakuumverpacken

Vacuum pack the ingredients

Embalamos os alimentos em vácuo

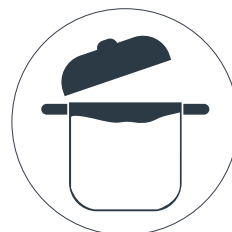

#### Llenamos una olla con agua

Remplir une marmite d'eau

Topf mit Wasser füllen

Fill a cooking pot with water

Enchemos uma panela com água



#### Programamos el tiempo y la temperatura

Programmer la durée et la température

Garzeit und -temperatur einstellen

Programme in the time and the temperature

Programamos o tempo e a temperatura



#### Esperamos a que emita un pitido

Attendre l'émission d'un signal sonore

Pfeifton abwarten

Wait for the beep

Esperamos que emita um aviso sonoro



#### Introducimos la bolsa dentro de la olla

Introduire le sachet dans la marmite

Vakuumbbeutel in den Topf geben

Place the bag into the pot

Introduzimos o saco com os alimentos dentro da panela



#### Retiramos la bolsa y ¡A disfrutar!

Retirer le sachet et, bonne dégustation !

Vakuumbbeutel entnehmen - Guten

Appetit!

Remove the bag and... Enjoy!

Retiramos o saco... e a desfrutar!



Con la Sous Vide Gourmet **podrás elaborar todo tipo de** carnes, pescados, huevos, frutas y verduras con resultados realmente sorprendentes

With the Sous Vide Gourmet **you can make all kinds of** meats, fish, eggs, fruits and vegetables with really surprising results



**Resultados sorprendentes · Résultats étonnants · Amazing results**

Alimentos jugosos · Tiernos · Suculentos  
Nourriture juteuse · Tendres · Juteux  
Juicy food · Tender · Succulent

· Professional use ·

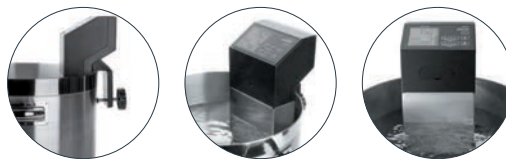

**Su diseño compacto hace que sea fácilmente almacenable y transportable**  
**Se sujeta a cualquier tipo de olla, cazuela o cubeta que pueda contener 20 L**

Sa conception compacte lui permet d'être plus facilement stockable et transportable  
Se fixe sur tout type de casserole, de marmite ou de cuve pouvant contenir 20 L

Auf Grund des kompakten Designs ist das Gerät einfach zu lagern und zu transportieren  
Kann an Töpfe, Kasserollen oder Behältnisse mit 20 l Fassungsvermögen befestigt werden

Its compact design makes it easy to store and transport  
It is attached to any type of pot, saucepan or tray that can contain 20 L

O seu desenho compacto faz com que seja fácil de armazenar e de transportar  
Sujeita-se a qualquer tipo de panela, caçarola ou recipiente que possa conter 20 L

**Cocedor a baja temperatura Portátil SOUS VIDE**

Thermlongeur cuisson basse température  
Tragbar Niedrigtemperatur heizkessel  
Portable low temperature cooker  
Fogao a baixa temperatura portátil

Ref	€	Pack
69192	376,00	1

Ref	Tensión/Voltage	Potencia/Power	Velocidad/Speed	Temperat./Temp.	Precisión/Precision	Capacidad/Cap.	Dimensiones/Sizes	Peso/Weight
69192	220-240 V / 50-60 Hz	1500 W	6 L/min.	5 - 99°C	0,1°C / 0,1°F	10 - 20 L	14x14x33 cm	1,93 Kg

• Semiprofessional use •

**New**

**A**



**B**



**Soft Touch**  
Soft Touch  
Soft Touch  
Soft Touch  
Soft Touch



**Pantalla táctil**  
Écran tactile  
Touch-Screen  
Touchscreen  
Ecrã tátil



**Fácil anclaje**  
Fixation simple  
Leicht zu fixieren  
Easy to attach  
Fácil de fixar



**Regulador Led**  
Régulateur Led  
LED-Regler  
LED controller  
Regulador Led

**Sous Vide GOURMET**

Sous Vide  
Sous Vide  
Sous Vide  
Sous Vide

	Ref	€	W	Pack
<b>A</b>	69302	165,10	800	1
<b>B</b>	69303	165,10	800	1



**Circulador de agua**  
Circulation d'eau  
Wasserumwälzsystem  
Water circulator  
Circulador de água



**Fácil limpieza**  
Nettoyage facile  
Einfach zu reinigen  
Easy to clean  
Fácil de limpar

Ref	Tensión/Voltage	Potencia/Power	Velocidad/Speed	Temperature/Temp.	Capacidad/Capacity	Dimensiones/Sizes	Peso/Weight
69302	220-240 V / 50 Hz	800 W	8,5 L/min	20-90°C (0,5°C)	15 L	Ø10x37 cm	1,0 Kg
69303	220-240 V / 50 Hz	800 W	8,5 L/min	20-90°C (0,5°C)	15 L	Ø10x37 cm	1,0 Kg

Incluye un **completo recetario** con todo tipo de recetas diseñado por Miriam Garcia ( [invitadoinvierno.com](http://invitadoinvierno.com)) **en exclusiva para Lacor**

Includes a complete recipe book with all kinds of recipes designed by Miriam Garcia ( [invitadoinvierno.com](http://invitadoinvierno.com)) **exclusively for Lacor**



## Bolas aislantes para Sous Vide

**New**

· Professional use ·

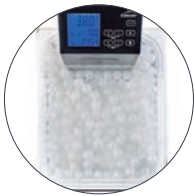

### Perfecta capa de aislamiento

Couche d'isolation parfaite  
 Perfekte Isoliertschichtung  
 Perfect insulation layer  
 Uma capa de isolamento perfeita

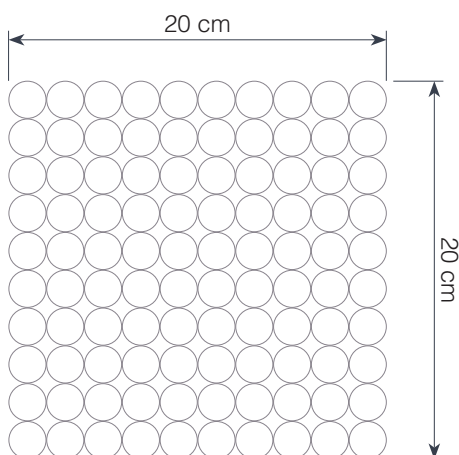

Área para 100 bolas (Ø 2 cm) es de 400 cm<sup>2</sup>  
 The area for 100 balls (Ø 2 cm) is 400 cm<sup>2</sup>

**Bolas aislantes huecas y flotantes de polipropileno (PP), libres de BPA, para dispositivos sous-vide**

**Crean una capa de aislamiento evitando la pérdida de calor en un 75% y en un 90% la evaporación del agua**

**Permiten hervir agua durante horas sin tener que echar más, gracias al mínimo contacto entre agua y aire**

**Aumentan la precisión de la temperatura y ayudan a mantener los envasados al vacío bajo el agua**

**Reducen humos y riesgos de salpicaduras**

**Soportan hasta 150°C sin ningún problema**

**Compatibles con recipientes de todas las formas y tamaños**

**Se presenta con una práctica malla con cierre de cordón**

Billes isolantes creuses et flottantes en polypropylène (PP), sans BPA, pour machines de conditionnement sous-vide.

Elles créent une couche d'isolation, évitant ainsi la perte de chaleur à hauteur de 75% et l'évaporation d'eau à hauteur de 90%.

Elles permettent de faire bouillir de l'eau pendant des heures sans avoir à en rajouter, grâce au contact minimum entre l'eau et l'air.

Elles augmentent la précision de la température et aident à maintenir sous l'eau les contenants sous-vide.

Elles réduisent les fumées et les risques d'éclaboussure.

Elles supportent jusqu'à 150°C sans aucun problème.

Elles sont compatibles avec des récipients de toutes formes et tailles.

Elles sont livrées dans un pratique filet doté d'une fermeture à cordon.

Thermoisolierende Schwimmkugeln aus Polypropylen (ohne BPA) für Sous-Vide-Geräte

Bilden eine Isolationsschicht und verringern Wärmeverlust um bis zu 75% und Verdunstung um bis 90%

Dank Thermoisolation kocht das Wasser stundenlang ohne nachzufüllen

Erhöhen die Temperaturgenauigkeit und halten die vakuumierten Lebensmittel unter Wasser

Wirken auch als Dampf- und Spritzschutz

Halten Temperaturen bis 150°C problemlos aus

Mit allen Sous-Vide-Tanks kompatibel

Inkl. praktischem Aufbewahrungsnetz mit Kordel

Hollow, floating, BPA-free polypropylene (PP) insulation balls for sous-vide devices

Create an insulation layer reducing heat loss by 75% and water evaporation by 90%

Enable you to boil water for hours without having to add more, thanks to the minimal contact between water and air

Increase temperature accuracy and help keep vacuum packs submerged

Reduce smoke and the risk of splashes

Withstand up to 150°C without any problem

Compatible with containers of all shapes and sizes

Come with a handy mesh drawstring bag

Esferas isolantes ocas e que flutuam, em polipropileno (PP), sem BPA, para dispositivos sous-vide

Criam uma capa de isolamento, evitando a perda de calor em 75%, e a evaporação da água em 90%.

Permitem ferver água durante horas sem que seja necessário acrescentar mais líquido, graças ao mínimo contacto entre a água e o ar

Aumentam a precisão da temperatura, e ajudam a manter os alimentos embalados em vácuo quando submergidos em água

Reduzem os fumos e os riscos de salpicaduras

Suportam até 150 °C sem qualquer problema

Compatíveis com recipientes de todas as formas e tamanhos

Fornecidas com um prático saco de rede com fecho de cordão



### Bolas aislantes para Sous Vide

Billes isolantes p/appareils de conditionnement Sous-Vide

Isolationskugeln für Sous-Vide

Sous Vide Insulation Balls

Esferas isolantes para Sous Vide

Ref	€	Ø (cm)	Unidad	Pack
69219	23,00	2,0	100	1

• Semiprofessional use •



**Cocedor a baja temperatura SOUS VIDE**

Cuiseur à basse température  
Niedrigtemperaturkocher  
Low temperature cooker  
Cozedor a baixa temperatura

Ref	€	Pack
69193	589,40	1



**Medidas cubeta interior: 30x24x20 cm**  
Container interior measures

**Se emplean bolsas herméticas que se sumergen en el agua caliente por debajo del punto de ebullición (60°C)**

Des sachets hermétiques sont utilisés pour immerger les aliments dans l'eau chaude en-deçà du point d'ébullition, soit environ 60°C

Es werden dicht abschließende Beutel verwendet, die in das heiße Wasser eingetaucht werden, unterhalb des Siedepunkts (60°C)

Uses hermetically sealed bags that are submerged into hot water below boiling point (60°C)

Utiliza bolsas herméticas, que se podem mergulhar em água quente abaixo do ponto de ebulição (60°C)

Ref	Tensión/Voltage	Potencia/Power	Velocidad/Speed	Temperat./Temp.	Precisión/Precision	Capacidad/Cap.	Dimensiones/Sizes	Peso/Weight
69193	220-240 V / 50-60 Hz	620 W	6 L/min	5 - 99°C	0,1°C / 0,1°F	11 -12,5 L	27x29x42 cm	6,30 Kg

• Semiprofessional use •

*Incluye Recetario*  
Recipe Book included



**Realice todo tipo de recetas**  
**11 funciones, función especial SOUS VIDE**

**Por sus características también podrás cocinar alimentos al estilo SOUS VIDE**  
**Accesorios incluidos: Parrilla para SOUS VIDE, cestillo freidora y bandeja para cocción al vapor**

**Cubeta interior con recubrimiento antiadherente WHITFORD QUANTANIUM de 3 capas, libre de PFOA**

Réalisez tous types de recettes

11 fonctions, fonction spéciale SOUS VIDE

Pour ses caractéristiques, vous pouvez également faire cuire la nourriture de style SOUS VIDE  
Accessoires inclus; Grill pour SOUS VIDE, panier pour friteuse et plateau pour poisson à la vapeur  
Bol intérieur avec revêtement antiadhésif WHITFORD QUANTANIUM 3 couches, sans PFOA

Für alle Rezepte

11 Funktionen, spezielle SOUS VIDE-Funktion

Durch seine Eigenschaften Sie können auch kochen SOUS-VIDE-Stil  
Inbegriffen Zubehör: Rost für SOUS VIDE, Frittierkorb und Dampfgarblech  
Innenschale mit Antihafbeschichtung WHITFORD QUANTANIUM 3-Schicht, frei von PFOA

Makes all kinds of recipes

11 functions; special SOUS VIDE function

For its characteristics you can also cook food SOUS VIDE style  
Included accessories: Grill for SOUS VIDE, deep-frying basket and tray for steaming  
Inside bowl with non-stick coating WHITFORD QUANTANIUM 3 layers, PFOA free

**Sous Vide multifunción**

Sous Vide multifunctions  
Sous Vide Multifunktions  
Sous vide multifunctions  
Sous Vide multifunções



Ref	€	Pack
69493	198,30	1

Ref	Tensión/Voltage	Potencia/Power	Temperat./Temp.	Precisión/Precision	Capacidad/Cap.	Dimensiones/Sizes	Peso/Weight
69493	220-230 V / 50-60 Hz	1500 W	5 - 99°C	0,1°C / 0,1°F	6 L	40,5x35x30 cm	4,80 Kg



## Vinoteca

· Semiprofessional use ·



**Diseñada para refrigerar eficazmente botellas de vino y otras bebidas**  
**La temperatura interior puede ser ajustada mediante el control electrónico**  
**Destaca por su elegante diseño y por su control táctil de temperatura**  
**Incorpora una práctica luz interior**  
**Deje suficiente espacio en la parte trasera (mínimo 5 cm) para permitir la salida del calor y una adecuada ventilación**

Conçue pour réfrigérer efficacement les bouteilles de vin et autre boissons  
 La température intérieure peut être réglée à l'aide du contrôle électronique  
 Elle se distingue par son design élégant et son contrôle de température tactile  
 Dispose d'un éclairage intérieur très pratique  
 Laissez suffisamment d'espace dans la partie arrière (minimum 5 cm) pour permettre la sortie de la chaleur et une bonne ventilation

Für die leistungsstarke Kühlung von Wein und anderen Getränken  
 Die Innentemperatur lässt sich elektronisch einstellen  
 Besonders durch elegantes Design und touchfähige Temperatureinstellung ausgezeichnet  
 Mit praktischer Innenbeleuchtung  
 Zur Gewährleistung der Wärmeabstrahlung und Belüftung genügend Abstand (5 cm) zur Wand halten

Designed to effectively cool bottles of wine and other beverages  
 The internal temperature can be adjusted using the electronic control  
 Stands out thanks to its elegant design and fingertip temperature control  
 Incorporates a practical interior light  
 Leave enough space at the back (minimum 5 cm) to allow heat to escape and adequate ventilation

Desenhado para refrigerar eficazmente garrafas de vinho e outras bebidas  
 Controlo eletrónico regulável da temperatura interior  
 Destaca-se pelo seu design elegante e pelo controlo tátil da temperatura  
 Incorpora uma prática luz interior  
 Recomendamos deixar um espaço suficiente entre o armário e a parede de trás (mínimo de 5 cm) para permitir a saída do calor e uma ventilação adequada

## Inox Line

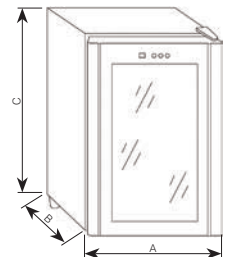

**Control electrónico de temperatura**  
**Puerta inoxidable**  
**Luz en el interior**  
**Nivel máx. ruido < 30 dBA**

Commande électronique de la température  
 Porte inoxydable  
 Lumière à l'intérieur  
 Niveau max. bruit < 30 dBA

Elektronische Steuerung der Temperatur  
 Edelstahl-Tür  
 Innenbeleuchtung  
 Max. Geräuschpegel < 30 dBA

Electronic temperature control  
 Rust-proof door  
 Light inside  
 Max noise level < 30 dBA

Control electrónico de temperatura  
 Porta inoxidable  
 Luz interior  
 Nivel máx. de ruido < 30 dBA

**Armarios refrigeradores eléctrico**  
 Refroidisseur à vin électrique  
 Thermoelektrischer Weinkühler  
 Thermoelectric wine cooler  
 Armário refrigerador eléctrico

	Ref	€	Pack
<b>A</b>	69078	209,30	1
<b>B</b>	69071	248,20	1
<b>C</b>	69072	323,30	1

Ref	Tensión/Voltage	Botellas/Bottles	Potencia/Power	Capacidad/Cap.	Temperature/Temp.	Consumo/Consump.	Dimensiones/Sizes A x B x C	Peso/Weight
69078	220-240 V / 50-60 Hz	8	70 W.	25 L	8 - 18°C	0,07 Kw/h	25x49x54 cm	4,40 Kg
69071	220-230 V / 50-60 Hz	16	70 W	46 L	12 - 18°C	0,07 Kw/h	44x48x51 cm	13,2 Kg
69072	220-230 V / 50-60 Hz	28	80 W	75 L	12 - 18°C	0,08 Kw/h	46x53x73 cm	17,2 Kg

# Black Line



**Armarios refrigeradores eléctrico**

Refrigerateur à vin électrique  
 Thermoelektrischer Weinkühler  
 Thermoelectric wine cooler  
 Armário refrigerador eléctrico

	Ref	€	Pack
<b>A</b>	69178	191,90	1
<b>B</b>	69171	265,60	1
<b>C</b>	69175	293,80	1
<b>D</b>	69187	191,90	1
<b>E</b>	69186	243,30	1
<b>F</b>	69185	325,10	1
<b>G</b>	69184	710,40	1

**Doble cámara · xxxxxx**  
**Doble cámara · xxxxxx**

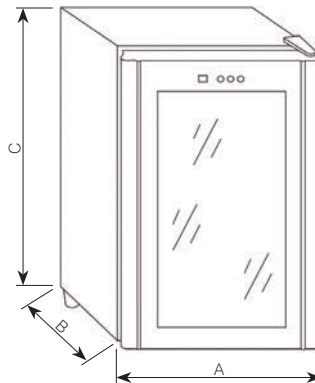

Doble cámara · T



Display temperatura · Temperature display  
 Control de temperatura (+/-) · Temperature touch control  
 Control de luz (ON/OFF) · Light control (ON/OFF)

Ref	Tensión/Voltage	Botellas/Bottles	Potencia/Power	Capacidad/Cap.	Temperature/Temp.	Consumo/Consump.	Dimensiones/Sizes A x B x C	Peso/Weight
69178	220-240 V / 50-60 Hz	8	50 W.	23 L	8 - 18°C	0,05 Kw/h	28x45x51 cm	9,40 Kg
69171	220-230 V / 50-60 Hz	18	70 W	48 L	12 - 18°C	0,07 Kw/h	38x50x65 cm	14,84 Kg
69175	220-230 V / 50-60 Hz	28	70 W	65 L	12 - 18°C	0,07 Kw/h	48x54x74cm	19,3 Kg
69187	220-230 V / 50-60 Hz	8	50 W	23 L	8 - 18°C	0,05 Kw/h	41x51x28 cm	9,4 Kg
69186	220-230 V / 50-60 Hz	16	70W	46 L	12 - 18°C	0,07 Kw/h	44x48x51 cm	15,5 Kg
69185	220-230 V / 50-60 Hz	18	100 W	48 L	8 - 18°C / 12 - 18°C	0,10 Kw/h	36x50x65 cm	16,0 Kg
69184	220-230 V / 50-60 Hz	48	180 W	140 L	10 - 18°C / 12 - 18°C	0,07 Kw/h	70x52x85 cm	41,5 Kg



## Mini-Bar

· Professional use ·



**Puerta reversible**  
 Porte réversible  
 Reversible Tür  
 Reversible door  
 Porta reversível

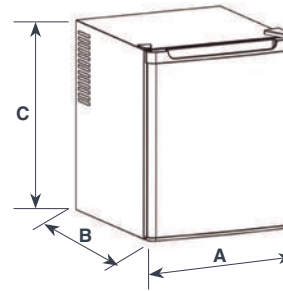

### Refrigerador Mini-Bar

Mini frigo bar  
 Minibar Kühlschrank  
 mini-Bar refrigerator  
 Refrigerador Mini-Bar

	Ref	€	Pack
<b>A</b>	69070	204,20	1
<b>B</b>	69075	204,20	1

Ref	Tensión/Voltage	Potencia/Power	Capacidad/Capac.	Temperatura/Temp.	Consumo/Cons.	Dimensiones/Sizes A x B x C	Peso/Weight
69070	220-240 V / 50-60 Hz	70 W	40 L	5°C - 12°C	25 W/h	43x41x51 cm	9,0 Kg
69075	220-240 V / 50-60 Hz	70 W	40 L	5°C - 12°C	25 W/h	43x41x51 cm	9,0 Kg

## Máquinas de hielo

· Professional use ·

Inox  
18/10



Tamaño y forma cubito hielo  
 Escala: 1:1

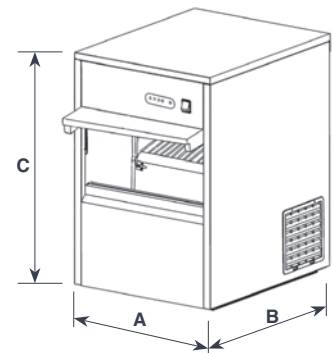
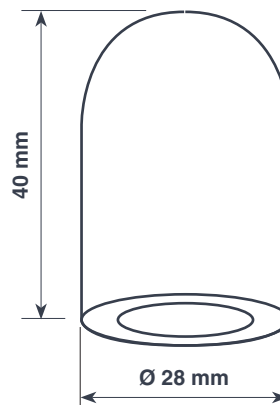

### Máquina de hacer hielo PRO

Machine à fabriquer des glaçons  
 Eiswürfelmaschine  
 Ice maker  
 Máquina de facer gelo

Ref	€	Pack
69320	856,90	1

Ref	Tensión/Voltage	Potencia/Power	Capacidad/Capacity	Cubo/Ice (Sizes)	Producción/Product.	Dimensiones/Sizes A x B x C	Peso/Weight
69320	220-240 V / 50-60 Hz	170 W	4 Kg	Ø28x40 mm	>20 Kg	38x48x59 cm	27 Kg

· Household use ·



Tamaño y forma cubito hielo  
Escala: 1:1

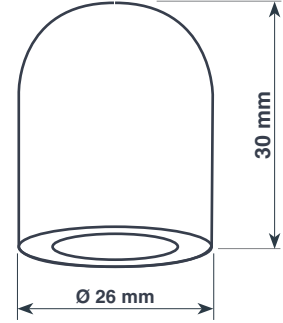

**Aproximadamente en 10 ó 12 minutos, obtendrá cubitos de hielo**  
**ECO: Ahorro de energía y bajo nivel de ruido**

En 10 ou 12 minutes environ, vous obtiendrez des glaçons  
ECO: Économie d'énergie et faible bruit

In ca. 10 bis 12 Minuten erhalten Sie Eiswürfel  
ECO: Energiesparen und Rauscharme

In approximately 10 to 12 minutes you will have ice cubes  
ECO: Power save and low noise

Cubos de gelo em aproximadamente 10 ou 12 minutos  
ECO: Economia de energia e baixo nível de ruído

**Máquina cubitos hielo**

Machine à glaçons  
Eis maschinen  
Ice cubes maker  
Maquina de fazer gelo

Ref	€	Pack
69314	331,00	1

Ref	Tensión/Voltage	Potencia/Power	Cap. hielo/Ice cap.	Capacidad/Capacity	Contenedor/Cont.	Dimensiones/Sizes	Peso/Weight
69314	220-240 V / 50-60 Hz	150 W	10-15 Kg/24h	1,50 L	600 g	32x32x38 cm	11,30 Kg

· Household use ·



**Cuchilla de acero inoxidable**  
**Pica rápidamente hielo para granizados y cócteles**

Lame en acier inoxydable  
Pile rapidement la glace pour des granités et des cocktails

Messer aus rostfreiem Stahl  
Mahlt Eis schnell für Eisgranulat und Cocktails

Stainless steel blade  
Crushes ice quickly for slushies or cocktails

Lâmina de aço inoxidável  
Pica rapidamente gelo para granizados e cocktails

**Picadora hielo**

Broyeur à glaçons  
Eis-Crusher  
Ice crusher  
Picadora de gelo

Ref	€	Pack
69310	65,50	1

Ref	Tensión/Voltage	Potencia/Power	Velocidad/Speed	Capacidad/Capacity	Dimensiones/Sizes	Peso/Weight
69310	220-240 V / 50-60 Hz	100 W	5 .500 r.p.m.	0,50 L	18x20,5x46,5 cm	5,10 Kg

## Glace

· Professional use ·



**Precios NO sujetos al sistema de descuentos habitual de LACOR**

Prix non soumis au système habituel de remises de LACOR  
Prices not subject to the usual discount system of LACOR

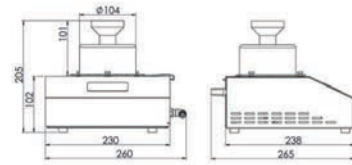

Permite fabricar pastillas de hielo seco de 100 g al momento y en cantidad que se precise de forma segura y controlada.  
Gracias a nuestra máquina GLACE, la alta cocina está al alcance de tu mano  
Fabricado en acero inoxidable  
Modelo portátil para uso sin instalación  
Conexión botella de 28 ó 36 Kg  
Sistema de conexión a la botella manual con sistema de seguridad incluido  
Pastilla de 100 g aproximadamente / Tamaño pastilla: Ø104 x 101 mm / Peso: 6 Kg

Allows to manufacture tablets of dry ice from 100 g at the time and in the amount required in a safe and controlled manner.  
Thanks to our GLACE, the cuisine machine is at your fingertips.  
Made of steel stainless  
Portable model for use without installation  
Connection to bottle of 28 or 36 Kg  
Manual with safety system including bottle system  
Pill of 100 g approximately / Pill size: Ø104 x 101 mm / Weight: 6 Kg

### Máquina elaborar hielo seco GLACE

Machine à faire la glace sèche  
Maschine machen Trockeneis  
Machine make dry ice  
Máquina de fazer gelo seco

Ref	€	Pack
69301	2.150,00	1

Ref	Tensión/Voltage	Potencia/Power	Pastillero/Pillbox	Programas/Program.	Dimensiones/Sizes	Peso/Weight
69301	220-240 V / 50-60 Hz	25 W	100 g	4	26x26,5x20,5 cm	6,0 Kg

## Freeze

· Professional use ·



**Precios NO sujetos al sistema de descuentos habitual de LACOR**

Prix non soumis au système habituel de remises de LACOR  
Prices not subject to the usual discount system of LACOR

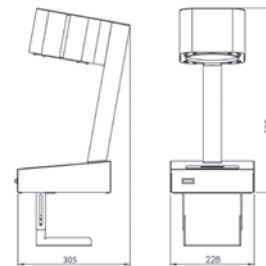

Gracias asu diseño, la FREEZE es perfecta para cualquier local ya que se adapta a todo tipo de superficies, ocupando el mínimo espacio  
Se puede ubicar donde se precise según las necesidades de cada ocasión  
Perfecta para negocios de mucha actividad  
Fabricado en acero inoxidable  
Conexión a botella de CO<sub>2</sub> de 28 ó 36 Kg  
Contador de operaciones  
Luces tipo LED de activación por impulsos de gas  
Sistema de conexión a botella con sistema de seguridad incluido

Thanks to its design, the FREEZE is perfect for any local adapts to all types of surfaces, taking up a minimum of space.  
Can be placed where required according to the needs of each occasion  
Perfect for busy business  
Made of steel stainless  
Connection to CO<sub>2</sub> bottle of 28 or 36 Kg  
Counter operations  
Lights activation type LED by impulses from gas  
Bottle with safety system including system

### Máquina enfriacopas FREEZE

Machine à givrer les verres  
Maschine Fuer Glas Cool  
Glass cooler machine  
Máquina para enfriar copas

Ref	€	Pack
69300	2.910,00	1

Ref	Tensión/Voltage	Potencia/Power	Programas/Program.	Dimensiones/Sizes	Peso/Weight
69300	220-240 V / 50-60 Hz	25 W	4	22,8x30,5x 50 cm	12 Kg



**Precios NO sujetos al sistema de descuentos habitual de LACOR**  
 Prix non soumis au système habituel de remises de LACOR  
 Prices not subject to the usual discount system of LACOR

#### ¿Qué tipo de gas utilizamos?

El gas que utilizan nuestras máquinas es Gas carbónico alimentario en estado líquido. El Dióxido de Carbono, también denominado óxido de carbono (IV), gas carbónico y anhídrido carbónico, CO<sub>2</sub>, es insípido, incoloro, inodoro y no inflamable.

Aunque la forma más común en que se encuentra el CO<sub>2</sub> es en estado gaseoso, bajo determinadas condiciones se puede encontrar también en estado líquido o sólido. Estas botellas están destinadas para uso médico y alimentario y lo que las diferencia del resto es que en su interior cuenta con una sonda que extrae el líquido criogénico que al liberarse alcanza una temperatura de -79,8 C°

#### Seguridad LACOR

- 1.- Funcionamiento a base de gas carbónico líquido alimentario
- 2.- Control de presión de gas. Control de temperatura de congelación del gas ajustable de -8 a -55°C
- 3.- Fabricado en Acero Inoxidable de uso médico y alimentario. Todos los conductos interiores están fabricados en AISI-316 garantizando las óptimas condiciones alimentarias e higiénico-sanitarias
- 4.- Adaptable a cualquier tamaño de copa o vaso
- 5.- Exclusivo sistema de seguridad patentado y control para presiones superiores a 100 bar

#### Nuestros artículos cumplen las siguientes normativas:

- 1.- Directiva 2006/95/CE de seguridad eléctrica
- 2.- Directiva 2006/108/CE de compatibilidad electromagnética
- 3.- Directiva 2006/42/CE de máquinas
- 4.- Norma UNE-EN ISO 12100-1:2004
- 5.- Norma UNE-EN ISO 12100-2:2004
- 6.- Norma EN 614-1:1996
- 7.- Norma UNE-EN ISO 13850:2007
- 8.- Norma UNE-EN 60335-1

#### Quel type de gaz utilisons-nous?

Le gaz employé dans nos machines est du gaz carbonique alimentaire en état liquide. Le dioxyde de carbone, également dénommé oxyde de carbone (IV), gaz carbonique ou CO<sub>2</sub>, est insipide, incolore, inodore et non inflammable.

La forme la plus commune de CO<sub>2</sub> est l'état gazeux, mais il est également possible de le trouver dans certaines conditions en état liquide ou solide.

Ces bouteilles sont destinées à un usage médical et alimentaire et ce qui les différencie du reste c'est qu'elles possèdent à l'intérieur une sonde qui extrait le liquide cryogénique qui atteint une température de -79,8 C° lorsqu'il est libéré.

#### Sécurité LACOR

- 1.- Fonctionnement basé sur du gaz carbonique liquide alimentaire
- 2.- Contrôle de la pression du gaz. Contrôle de la température de congélation du gaz réglable de -8 à -55°C
- 3.- Conception en acier inoxydable à usage médical et alimentaire. Tous les conduits intérieurs sont fabriqués en AISI-316 pour garantir des conditions alimentaires, hygiéniques et sanitaires optimales
- 4.- Adaptable aux différentes tailles de verres
- 5.- Système de sécurité exclusif et breveté et contrôle pour des pressions supérieures à 100 bar

#### Nos articles remplissent les réglementations suivantes:

- 1.- Directive 2006/95/CE basse tension
- 2.- Directive 2006/108/CE de compatibilité électromagnétique
- 3.- Directive 2006/42/CE machines
- 4.- Norme UNE-EN ISO 12100-1:2004
- 5.- Norme UNE-EN ISO 12100-2:2004
- 6.- Norme EN 614-1:1996
- 7.- Norme UNE-EN ISO 13850:2007
- 8.- Norme UNE-EN 60335-1

#### What type of gas do we use?

Our machines use liquid food grade Carbon dioxide gas. Carbon Dioxide, also called carbon oxide (IV), carbonic gas and carbon anhydride, CO<sub>2</sub>, is insipid, colourless, odourless and not flammable.

Although the most common state of CO<sub>2</sub> is gaseous, under certain conditions it can also be found in liquid or solid state. These bottles are used for medical and food uses and they are different from the rest in that their interiors have a probe that extracts the cryogenic liquid which when freed reaches temperatures of -79.8 C°

#### LACOR Safety

- 1.- Operability based on liquid food grade carbon dioxide gas
- 2.- Control of gas pressure. Control of freezing temperature of the gas adjustable from -8 to -55 C°
- 3.- Manufactured from Stainless Steel for medical and food use. All the internal conduits are manufactured from AISI-316 guaranteeing optimal food and hygienic-health condition
- 4.- Adaptable to any size of glass
- 5.- Exclusive patented safety system and control for pressures above 100 bar

#### Our articles fulfil the following standards:

- 1.- Directive 2006/95/CE for electrical safety
- 2.- Directive 2004/108/EC for electromagnetic compatibility
- 3.- Directive 2006/42/CE for machinery
- 4.- UNE-EN ISO 12100-1:2004 Standard
- 5.- UNE-EN ISO 12100-2:2004 Standard
- 6.- EN 614-1:1996 Standard
- 7.- UNE-EN ISO 13850:2007 Standard
- 8.- UNE-EN 60335-1 Standard

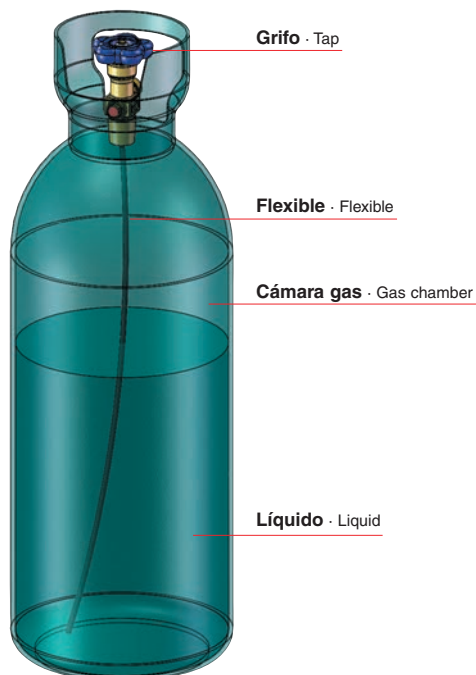



## Afilador

· Household use ·



**Fase 1:** Alta abrasividad · High abrasiveness  
**Fase 2:** Afilado fino · Thin sharp  
**Fase 3:** Micro-afilado · Micro-sharp



**Afilador de cuchillos eléctrico**  
 Affûteuse de couteaux électrique  
 Elektrische Schärfmaschine  
 Electric knife sharpener  
 Afiador de facas electrónico



Ref	€	Pack
69261	80,80	1

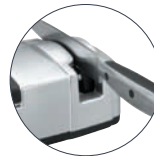

**Afilador de cuchillos eléctrico**  
 Affûteuse de couteaux électrique  
 Elektrische Schärfmaschine  
 Electric knife sharpener  
 Afiador de facas electrónico



Ref	€	Pack
60359	38,30	6

**Afilador de cuchillos eléctrico**  
 Affûteuse de couteaux électrique  
 Elektrische Schärfmaschine  
 Electric knife sharpener  
 Afiador de facas electrónico



Ref	€	Pack
69141	24,30	6

Ref	Tensión/Voltage	Potencia/Power	Dimensiones/Sizes	Peso/Weight
69261	220-240 V / 50-60 Hz	80 W	32x11,5x10 cm	2,20 Kg
69141	220-240 V / 50 Hz	60 W	13,5x15x9 cm	0,64 Kg
60359	220-240 V / 50-60 Hz	60 W	16x11x7,5 cm	0,56 Kg

## Esterilizadores

· Professional use ·

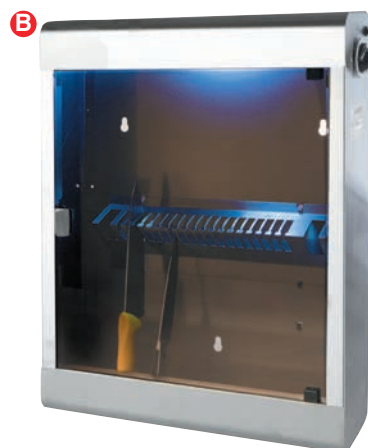

**Esterilización mediante rayos ultravioletas germicidas que transforman el oxígeno en ozono, destruyendo bacterias, hongos y virus**

Stérilisation à travers des rayons ultra-violetes germicides qui transforment l'oxygène en ozone, détruisant ainsi les bactéries, les champignons et les virus

Sterilisation mithilfe von keimtötender ultravioletter Strahlung, die Sauerstoff in Ozon umwandelt und dadurch Bakterien, Pilze und Viren vernichtet

Sterilisation by ultraviolet germicidal rays that transform oxygen into ozone, destroying bacteria, fungi and viruses

Esterilização mediante raios ultravioleta germicidas, que transformam o oxigênio em ozono, destruindo bactérias, fungos e vírus

**Armario esterilizador cuchillos ultravioleta**  
 Armoire à stériliser  
 Sterilisierungsschank  
 Knife sterilization  
 Armário esterilizador facas

Ref	€	Pack	
<b>A</b> 39012	544,00	1	10 cuchillos · 10 Knifes
<b>B</b> 39124	729,20	1	20 cuchillos · 20 Knifes

Ref	Cuchillos/Knives	Tensión/Voltage	Potencia/Power	Reloj/Timer	Dimensiones/Sizes	Peso/Weight
39012	10	230 V / 50-60 Hz	15 W	120 min	36x13x57 cm	4,785 Kg
39124	20	230 V / 50-60 Hz	15 W	120 min	45x13x57 cm	5,630 Kg

# Pizarras

· Professional use ·

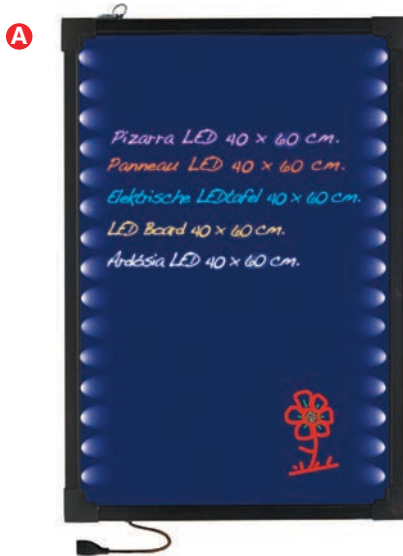

**NO incluidos**  
 NOT included

**Sistema de gran impacto visual. Crea tus propios diseños**  
**Muy fácil de usar, dibuja o escribe encima con los rotuladores fluorescentes especiales, pero NUNCA con la pizarra encendida**  
**Se borra con un trapo**  
**Se pueden colocar tanto vertical como horizontalmente**  
**Consumo muy poco**

Système d'un grand impact visuel. Concevez vos propres créations.  
 Très facile à utiliser, dessinez ou écrivez dessus avec les feutres fluorescents spéciaux mais JAMAIS lorsque le tableau est allumé.  
 S'efface avec un chiffon  
 Peut être installé aussi bien à la verticale qu'à l'horizontale  
 Consomme très peu

System mit Blickfang-Effekt. Schaff Dein eigenes Design  
 Ganz einfach im Gebrauch, schreib oder zeichne mit den fluoreszierenden Spezialstiften, aber NIE wenn die Tafel eingeschaltet ist  
 Mit Lappen auswischen  
 Lässt sich sowohl waagrecht als auch senkrecht aufhängen  
 Gering im Verbrauch

Very eye-catching system. Create your own designs  
 Very easy to use; draw or write on it with the special fluorescent markers, but NEVER when the blackboard is on  
 Wipes clean with a cloth  
 Can be placed both vertically and horizontally  
 Consumes very little power

Sistema de grande impacto visual, para criar os seus próprios desenhos.  
 Muito fácil de utilizar, permite desenhar ou escrever em cima com os rotuladores fluorescentes especiais  
 NUNCA escreva no quadro com este ligado  
 A escrita apaga-se com um trapo  
 Podem colocar-se vertical ou horizontalmente  
 Baixo consumo

## Pizarra eléctrica LED

Tableau lumineux à LED  
 Elektronische LED Tafel  
 Electric blackboard LED  
 Ardósia LED eléctrico

	Ref	€	Pack
<b>A</b>	39140	77,30	1
<b>B</b>	39160	106,10	1

## Rotuladores fluorescentes 8 colores

Marqueurs fluorescents 8 couleurs  
 8-Farben fluoreszierenden marker  
 4Fluorescent markers 8 colors  
 Maracadores fluirescentes 8 cores

Ref	€	cm	Pack
39161	25,50	10	1



Ref	Tensión/Voltage	Potencia/Power	Funcioned/Functions	Dimensiones/Sizes	Peso/Weight
39140	220-240 V / 50-60 Hz	2 W	38	40x60 cm	2,35 Kg
39160	220-240 V / 50-60 Hz	2 W	38	60x80 cm	4,50 Kg

# Matamosquitos



**Luz ultravioleta que atrae a los insectos y los elimina una vez que se encuentran cerca**  
Higiénicos

La lumière ultra-violette attire les insectes et les élimine lorsqu'ils sont à proximité  
Hygiéniques

UV-Licht, das Insekten anzieht und diese eliminiert, sobald sie sich in der Nähe befinden  
Hygienisch

Ultraviolet light that attracts bugs and eliminates them once they are close  
Hygienic

Luz ultravioleta que atraí os bichos e os elimina quando estão perto  
Higiénicos

· Professional use ·

**A**



**B**



**Mata mosquitos electrónico**

Appareil anti-moustiques électrique  
Elektrofliegenfänger  
Electric mosquito killer  
Mata mosquitos eléctrico

	Ref	€	Pack
<b>A</b>	39128	74,20	1
<b>B</b>	39137	91,20	1

· Household use ·

**A**



**B**

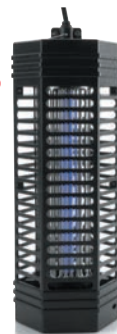

**Mata mosquitos electrónico negro**

Appareil anti-moustiques électrique noir  
Elektrofliegenfänger, schwarz  
Electric mosquito killer black  
Mata mosquitos eléctrico preto

	Ref	€	Pack
<b>A</b>	39138	15,90	1
<b>B</b>	39139	18,20	1

· Household use ·



**Mata mosquitos electrónico**

Appareil anti-moustiques électrique  
Elektrofliegenfänger  
Electric mosquito killer  
Mata mosquitos eléctrico

	Ref	€	Pack
	39133	28,10	1

Ref	Tensión/Voltage	Potencia/Power	Area protec./Prot. area	Dimensiones/Sizes	Peso/Weight
39128	220-240 V / 50-60 Hz	22 W	60 - 80 m <sup>2</sup>	33,8x9,9x26 cm	2,20 Kg
39137	220-240 V / 50-60 Hz	33 W	100 - 1200 m <sup>2</sup>	50,3x10x26 cm	2,83 Kg
39138	220-240 V / 50-60 Hz	4 W	40 m <sup>2</sup>	Ø12x25 cm	350 g
39139	220-240 V / 50-60 Hz	6 W	60 m <sup>2</sup>	Ø12x33 cm	875 g
39133	220-240 V / 50-60 Hz	13 W	50 m <sup>2</sup>	Ø27x27 cm	950 g





Calentadores  
Terrace Heater  
#CocinaConLacor



# Calentadores Eléctricos

· Professional use ·

**Ideal para bares y restaurantes con mesas en el exterior. Funciona mediante lámparas de calentamiento halógeno infrarrojos. Malla protectora para evitar quemaduras. Resistente al polvo y agua (IP)**

Idéal pour les bars et les restaurants ayant des tables à l'extérieur. Fonctionne à l'aide de lampes de réchauffement halogènes par infrarouges. Maillage de protection pour éviter les brûlures. Résistant à la poussière et à l'eau (IP)

Ideal für Bars und Restaurants mit Tischen im Freien. Arbeitet mit infraroten Halogenheizlampen. Gitter schützt vor Verbrennungen. Staub- und Wasserabweisend

Ideal for bars and restaurants with tables outside. Powered by infrared halogen heating lamps. Protective mesh to prevent burns. Dust and water resistant (IP)

Ideal para bares e restaurantes com mesas no exterior. Funciona com lâmpadas de aquecimento de halogéneo por infravermelhos. Malha de proteção para evitar queimaduras. Resistente ao pó e à água (IP)

¿Qué es la clasificación IP? · What is the IP classification?

**IP 67**

1º dígito; protección contra objetos y polvo 1st digit; protection against objects and dust	2º dígito; protección contra líquidos 1st digit; protection against liquids
<p><b>IP0:</b> Sin protección · Without protection</p> <p><b>IP1:</b> Protección contra objetos con un Ø mayor de 50 mm Protection against objects with Ø greater than 50 mm</p> <p><b>IP2:</b> Protección contra objetos con un Ø mayor a 12 mm Protection against objects with Ø greater than 12 mm</p> <p><b>IP3:</b> Protección contra objetos con un Ø mayor a 2,5 mm Protection against objects with Ø greater than 2,5 mm</p> <p><b>IP4:</b> Protección contra objetos con un Ø mayor a 1 mm Protection against objects with Ø greater than 1 mm</p> <p><b>IP5:</b> Protección contra polvo · Protection against dust</p> <p><b>IP6:</b> A prueba de polvo · Testing against dust</p>	<p><b>IPX0:</b> Sin protección · Without protection</p> <p><b>IPX1:</b> Protección contra gotas de agua Protection against water drops</p> <p><b>IPX2:</b> Protección contra el goteo de agua con una inclinación de 15° · Protection against dripping water with an inclination of 15°</p> <p><b>IPX3:</b> Protección contra pulverización Protection against spray</p> <p><b>IPX4:</b> Protección contra salpicaduras · Splash protection</p> <p><b>IPX5:</b> Protección contra chorros de agua Protection against water jets</p> <p><b>IPX6:</b> Protección contra aguaceros Protection against downpours</p> <p><b>IPX7:</b> Protección contra la inmersión durante un tiempo determinado · Protection against immersion for a certain time</p> <p><b>IPX8:</b> Protección contra permanencia bajo agua Protection against permanence under water</p>



**Calentador Eléctrico**  
Rechauffeur électrique  
Elektrischer Heizung  
Electric lamp  
Aquecedor eléctrico

**Mesa terraza calentadora**  
Table terrasse avec chauffage  
Terrassentisch mit Heizelement  
Table terrace heater  
Mesa esplanada com aquecedor

Ref	€	Pack
69412	367,20	1

Ref	€	Pack
69413	375,50	1

Ref	Tensión/Voltage	Potencia/Power	IP	Altura/Height	Calent./Heating	Dimensiones/Sizes	Peso/Weight
69412	220-240 V / 50-60 Hz	2000 W	IP24	140 cm	Lámp. calentamiento Halógeno infrarrojos	Ø50x140 cm	19,40 Kg
69413	220-240 V / 50Hz	1500 W	IP55	110 cm	Halogen infrared heating lamp	Ø60x110 cm	17,00 Kg

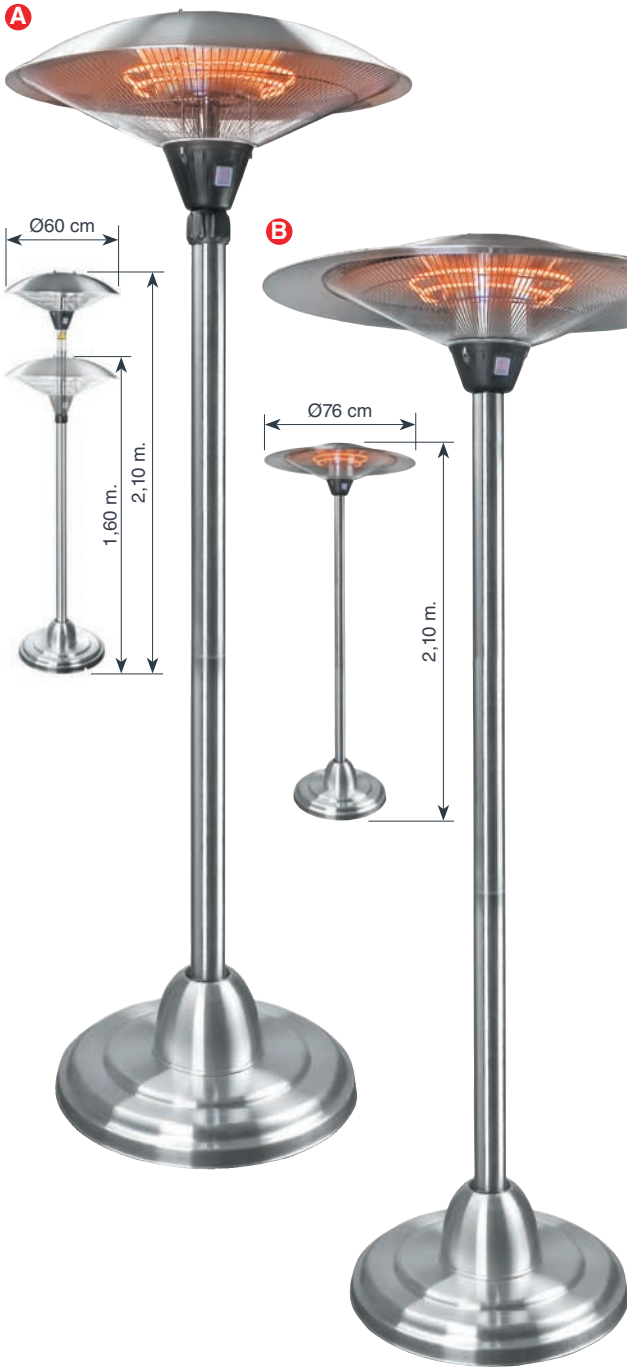

**Lámpara calentador eléctrico**  
 Lampe électrique chauffe  
 Heizelement, elektrisch, freihängend  
 Electric lamp  
 Lâmpada eléctrica aquecedora

	Ref	€	Pack
<b>A</b>	69420	134,90	1
<b>B</b>	69421	181,80	1

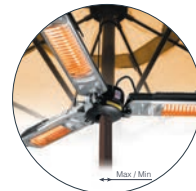

Max: Ø6 cm  
 Min: Ø2,5 cm

**Calentador eléctrico brazos abatibles**  
 Lampe chauffée électrique bras rebattables  
 Elekt. Heizgerät Arme ausklappbar  
 Electric heating lamp arms fold-away  
 Aquecedora eléctrica braços rebatíveis

Ref	€	Pack
69423	179,40	1



**Soporte abierto** · Support open: 28,5 cm  
**Soporte cerrado** · Support closed: 17 cm

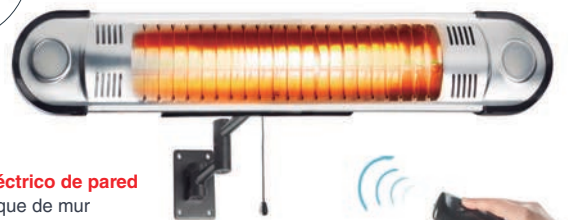

**Calentador eléctrico de pared**  
 Chauffe électrique de mur  
 Elekt. Heizung, Hängeleiste  
 Wall electric lamp  
 Aquecedora eléctrica de parede

Ref	€	Pack
69424	233,70	1

**Calentador eléctrico pie**  
 Rechauffeur électrique pied  
 Elektrische Heizung m/Ausziehbarer Fuß  
 Electric lamp  
 Aquecedor eléctrico com pé

	Ref	€	Pack
<b>A</b>	69410	261,30	1
<b>B</b>	69411	312,70	1

Ref	Tensión/Voltage	Potencia/Power	IP	Altura/Height	Calent./Heating	Dimensiones/Sizes	Peso/Weight
69410	220-240 V / 50-60 Hz	2100 W	IP44	2,10 m		Ø58,5x1,6 -2,05 m	14,60 Kg
69411	220-240 V / 50-60 Hz	1200-1800-3000 W	IP44	2,10 m		Ø76x2,10 m	18,00 Kg
69420	220-240 V / 50-60 Hz	1500 W	IP24	-	Lámp. calentamiento Halógeno infrarrojos	Ø42,5x25 cm	2,40 Kg
69421	220-240 V / 50-60 Hz	900/1200/2100 W	IP24	-		Ø58,5x35 cm	4,60 Kg
69423	220-240 V / 50-60 Hz	2000 W	IP34	-	Halogen infrared heating lamp	Ø100x8,5 cm	3,60 Kg
69424	220-240 V / 50-60 Hz	1500 W	IP55	-		75x13x13 cm	3,60 Kg

## Calentadores Gas

· Professional use ·

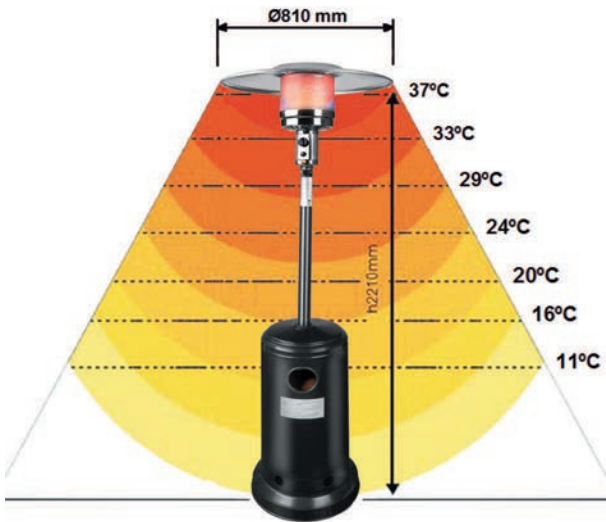

Outside temperature: 8°C – Wind: 0 m/sec. (outside)



**Ideal para bares y restaurantes con mesas en el exterior**

**Indicado única y exclusivamente para exteriores**

**Disponibile en dos acabados diferentes: Acero inoxidable · Negro**

**Resistente al polvo y agua (IP). Malla protectora para evitar quemadura**

Idéal pour les bars et les restaurants ayant des tables à l'extérieur

Destiné uniquement et exclusivement pour un usage en extérieur

Disponibile en deux finitions différentes : Acier inoxydable · Noir

Résistant à la poussière et à l'eau (IP). Maille de protection pour éviter les brûlures

Idéal für Bars und Restaurants mit Tischen im Freien

Nur für den Außenbereich geeignet

In zwei verschiedenen Ausführungen erhältlich: Edelstahl · Schwarz

Staub- und Wasserfest (IP). Schutzgitter zum Vermeiden von Verbrennungen

Idéal for bars and restaurants with tables outside

Exclusively for outdoor use

Available in two different finishes: Stainless steel · Black

Resistant to dust and water (IP). Protective mesh to prevent burns

Idéal para bares e restaurantes com mesas no exterior

Indicado única e exclusivamente para exteriores

Disponível em dois acabamentos diferentes, aço inoxidável e preto

Resistente ao pó e à água (IP). Rede protectora para evitar queimaduras



### Calentador terraza a gas

Chauffage de terrasse à gaz

Gas-Terrassenheizstrahler

Outdoor gas heater

Aquecedor a gás para terraços

Ref	€	Pack	
69400	301,50	1	España
69400F	301,50	1	Francia
69400P	301,50	1	Portugal
69401	228,10	1	España
69401F	228,10	1	Francia
69401P	228,10	1	Portugal

A

B

**Funciona con gas propano o butano** · Uses propane or butane gas only

**Solo para uso en exteriores** · Only for outdoor use

Ref	Potencia/Power	Posición piloto/Pilot posit.	Altura/Height	Peso/Weight
69400	12 KW (max.)	870 g/h	2,245 m	20 Kg
69401	12 KW (max.)	870 g/h	2,245 m	22 Kg



**Funda para calentador terraza a gas**

Housse pour chauffage de terrasse à gaz  
 Abdeckung für Gas-Terrassenheizstrahler  
 Cover for outdoor gas heater  
 Capa protectora para aquecedor a gás para terraços

Ref	€	Pack
R69400N	13,30	4

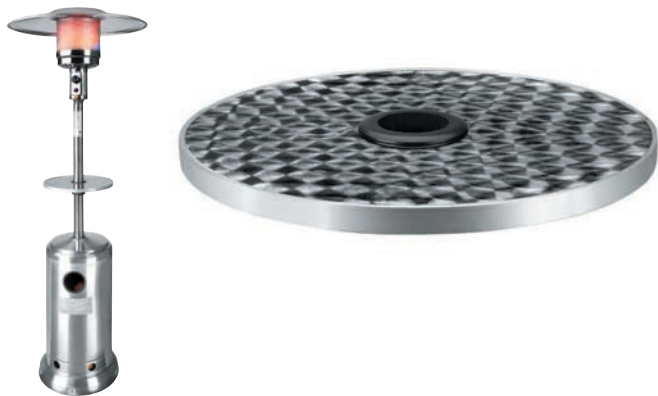

**Mesa para calentador terraza a gas**

Tableau pour chauffage de terrasse à gaz  
 Tablett für Gas-Terrassenheizstrahler  
 Table for outdoor gas heater  
 Tabela para aquecedor a gás para terraços

Ref	€	Ø (cm)
R69400A	30,10	40

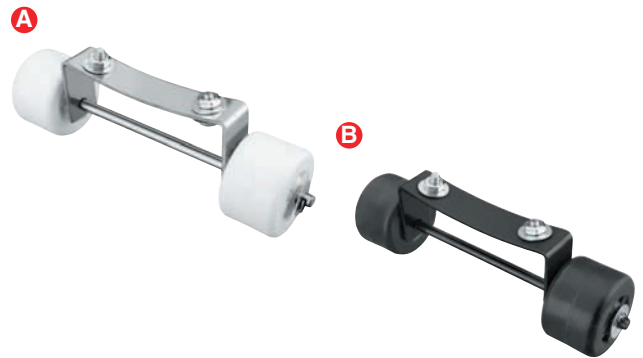

**Jgo. ruedas acero para calentador terraza**

Ensemble de roves pour chauffage de terrasse à gaz  
 Rollen für Gas-Terrassenheizstrahler  
 Wheel set for outdoor gas heater  
 Jogo de rodas para aquecedor a gás para terraços

	Ref	€	Pack
<b>A</b>	R69400B	8,50	1
<b>B</b>	R69400R	8,50	1



# Cartel

**Cartel promocional**

Affiche promotionnelle  
 Werbe-Plakat  
 Promotional poster  
 Poste promocional

	Ref	cm
<b>A</b>	99915	42x59,4
<b>B</b>	99916	42x59,4
<b>C</b>	99917	42x59,4
<b>D</b>	99918	42x59,4
<b>E</b>	99919	70x100
<b>F</b>	99920	70x100
<b>G</b>	99921	70x100
<b>H</b>	99922	70x100

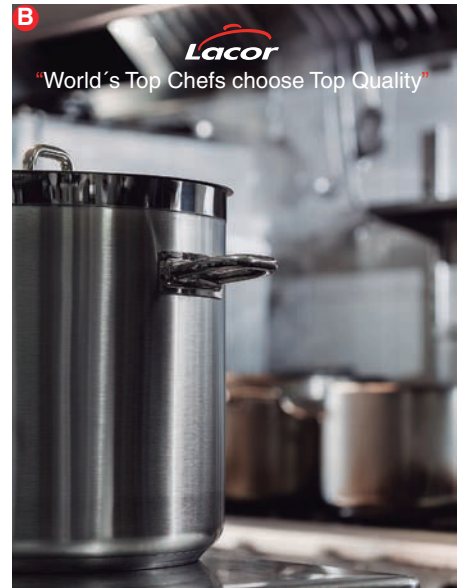

## Expositores Pie

**Expositor**  
 Expositant  
 Aussteller  
 Exhibitor  
 Expositor

	Ref	AxBxC (cm)	
<b>A</b>	00722	57,5x38x192,5	Bandejas · Trays
<b>B</b>	00723	57,5x38x192,5	Ganchos · Hooks
<b>C</b>	00724	57,5x38x192,5	Mixto · Mix

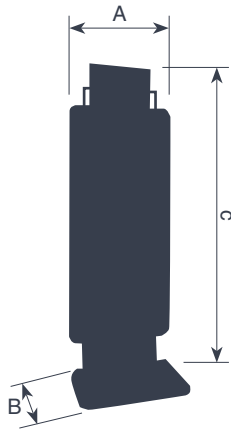



## Expositores Mesa

### Expositor SLOW JUICER

Exposant  
Austeller  
Exhibitor  
Expositor

Ref	cm	
10025	43x39,5x50,5	ES
10026	43x39,5x50,5	FR
10027	43x39,5x50,5	EN



\* NOTA: El expositor se manda vacío  
REMARQUE: L'exposant est envoyé vide  
HINWEIS: Der Aussteller ist leer gesendet  
NOTE: The exhibitor is sent empty  
NOTA: El expositor se manda vacío

### Expositor MENU

Exposant  
Austeller  
Exhibitor  
Expositor

Ref	cm
00725	36x26x42,5



\* NOTA: El expositor se manda vacío  
REMARQUE: L'exposant est envoyé vide  
HINWEIS: Der Aussteller ist leer gesendet  
NOTE: The exhibitor is sent empty  
NOTA: El expositor se manda vacío

### Expositores

Exposant  
Austeller  
Exhibitor  
Expositor



**Batidora profesional Black (69195)**



**Batidora profesional White (69295)**



**Máquina de vacío Compact (69351)**



**Sous Vide Gourmet (69302)**



**Spirelli eléctrico (69370)**

	Ref	
ES	17104	Expositor+50 folletos
	17104B	50 folletos (ES)
FR	17104F	Exposant+50 brochure
	17104BF	50 brochure (FR)
EN	17104G	Exhibitor+50 brochure
	17104BG	50 brochure (EN)

	Ref	
ES	17105	Expositor+50 folletos
	17105B	50 folletos (ES)
FR	17105F	Exposant+50 brochure
	17105BF	50 brochure (FR)
EN	17105G	Exhibitor+50 brochure
	17105BG	50 brochure (EN)

	Ref	
ES	17106	Expositor+50 folletos
	17106B	50 folletos (ES)
FR	17106F	Exposant +50 brochure
	17106BF	50 brochure (FR)
EN	17106G	Exhibitor+50 brochure
	17106BG	50 brochure (EN)

	Ref	
ES	17107	Expositor+50 folletos
	17107B	50 folletos (ES)
FR	17107F	Exposant +50 brochure
	17107BF	50 brochure (FR)
EN	17107G	Exhibitor+50 brochure
	17107BG	50 folletos (EN)

	Ref	
ES	17108	Expositor+50 folletos
	17108B	50 folletos (ES)
FR	17108F	Exposant+50 brochure
	17108BF	50 brochure (FR)
EN	17108G	Exhibitor +50 brochure
	17108BG	50 brochure (EN)



**Repuestos**



**Pièces détachée**



**Spares**









Ref.	Repuesto	Descripción	Description	Description	€
14212	R14212A	Mango cazo Garinox ø 12,14	Poignee casserole Garinox ø 12, 14	Long handle saucepan Garinox ø 12 ,14	3,45
14214	R14212A	Mango cazo Garinox ø 12,14	Poignee casserole Garinox ø 12, 14	Long handle saucepan Garinox ø 12 ,14	3,45
14216	R14216A	Mango cazo/sautex Garinox ø 16,18,20,24	Poignee casserole Garinox ø 16,18,20,24	Long handle saucepan Garinox 16,18,20,24	3,65
14218	R14216A	Mango cazo/sautex Garinox ø 16,18,20,24	Poignee casserole Garinox ø 16,18,20,24	Long handle saucepan Garinox 16,18,20,24	3,65
14220	R14216A	Mango cazo/sautex Garinox ø 16,18,20,24	Poignee casserole Garinox ø 16,18,20,24	Long handle saucepan Garinox 16,18,20,24	3,65
14318	R14318A	Asa lateral cacerola/olla Garinox	Anse pour faitout/marmite Garinox	Side handle casserole/stock pot Garinox	2,35
14320	R14318A	Asa lateral cacerola/olla Garinox	Anse pour faitout/marmite Garinox	Side handle casserole/stock pot Garinox	2,35
14322	R14318A	Asa lateral cacerola/olla Garinox	Anse pour faitout/marmite Garinox	Side handle casserole/stock pot Garinox	2,35
14324	R14318A	Asa lateral cacerola/olla Garinox	Anse pour faitout/marmite Garinox	Side handle casserole/stock pot Garinox	2,35
14418	R14318A	Asa lateral cacerola/olla Garinox	Anse pour faitout/marmite Garinox	Side handle casserole/stock pot Garinox	2,35
14420	R14318A	Asa lateral cacerola/olla Garinox	Anse pour faitout/marmite Garinox	Side handle casserole/stock pot Garinox	2,35
14422	R14318A	Asa lateral cacerola/olla Garinox	Anse pour faitout/marmite Garinox	Side handle casserole/stock pot Garinox	2,35
14424	R14318A	Asa lateral cacerola/olla Garinox	Anse pour faitout/marmite Garinox	Side handle casserole/stock pot Garinox	2,35
14624	R14216A	Mango cazo/sautex Garinox ø 16,18,20,24	Poignee casserole Garinox ø 16,18,20,24	Long handle saucepan Garinox 16,18,20,24	3,65
20800	20802	Pomo tapa olla p. Robust	Bouton de couvercle	Robust pressure cooker knob	22,50
20800	20803	Pomo de puente	Pont bouton	Bridge knob	5,40
20800	20805	Val.coccion o.p.Robust con chimenea	Valve de cuisson Robust	Cooking valve Robust	55,95
20800	20806	Valv.desvap.olla p.	Valve pour ouverture Robust	Robust unvaporization valve	31,35
20800	20808	Asa costado o.p.Robust mediana/grande	Anse du corp pour Robust m/g	handle for body Robust m/b	7,65
20800	20821	Junta goma o.p.gran.	Grad joint de caoutchouc	Rubber for lid pressure cooker big	163,50
20800	20827	Puente acero o.p. g.	Grand pont acier	Big st.st.bridge	115,40
20800	20835	Rejilla Robust grande	Grille perforee Robust grande	Perforated piece big Robust	67,55
20800	R20804	Pasador largo o.p.Robust	Grande goupille autocuiseur Robust	Robust pressure cooker long pin	6,10
20800	R20806	Arandela elastica o.p.Robust	Rondelle elastique autocuiseur Robust	Robust pressure cooker plastic washer	1,10
20800	R20834	Pomo extra tapa 20834	Extra bouton pour 20834	Extra knob for 20834	5,20
20812	20802	Pomo tapa olla p. Robust	Bouton de couvercle	Robust pressure cooker knob	22,50
20812	20803	Pomo de puente	Pont bouton	Bridge knob	5,40
20812	20805	Val.coccion o.p.Robust con chimenea	Valve de cuisson Robust	Cooking valve Robust	55,95
20812	20806	Valv.desvap.olla p.	Valve pour ouverture Robust	Robust unvaporization valve	31,35
20812	20808	Asa costado o.p.Robust mediana/grande	Anse du corp pour Robust m/g	handle for body Robust m/b	7,65
20812	20821	Junta goma o.p.gran.	Grad joint de caoutchouc	Rubber for lid pressure cooker big	163,50
20812	20827	Puente acero o.p. g.	Grand pont acier	Big st.st.bridge	115,40
20812	20835	Rejilla Robust grande	Grille perforee Robust grande	Perforated piece big Robust	67,55
20812	R20804	Pasador largo o.p.Robust	Grande goupille autocuiseur Robust	Robust pressure cooker long pin	6,10
20812	R20806	Arandela elastica o.p.Robust	Rondelle elastique autocuiseur Robust	Robust pressure cooker plastic washer	1,10
20812	R20834	Pomo extra tapa 20834	Extra bouton pour 20834	Extra knob for 20834	5,20
20815	20802	Pomo tapa olla p. Robust	Bouton de couvercle	Robust pressure cooker knob	22,50
20815	20803	Pomo de puente	Pont bouton	Bridge knob	5,40
20815	20805	Val.coccion o.p.Robust con chimenea	Valve de cuisson Robust	Cooking valve Robust	55,95
20815	20806	Valv.desvap.olla p.	Valve pour ouverture Robust	Robust unvaporization valve	31,35
20815	20811	Junta goma o.p.peq.	Petit joint de caoutchouc	Rubber for small lid	71,75
20815	20817	Puente acero o.p. p.	Petit pont acier	Small st.st.bridge	54,45
20815	20818	Asa costado pequena para olla p.Robust	Anse du corp pour Robust petit	Handle for body Robust small	6,10
20815	20836	Tapa olla Robust pequena	Couvercle cocotte p. petite Robust	Lid for pressure cooker Robust small	206,45
20815	20837	Rejilla Robust pequena	Grille perforee Robust petite	Perforated piece small Robust	24,95
20815	R20805	Pasador corto o.p.Robust	Petite goupille autocuiseur Robust	Robust pressure cooker short pin	5,50
20815	R20806	Arandela elastica o.p.Robust	Rondelle elastique autocuiseur Robust	Robust pressure cooker plastic washer	1,10
20820	20802	Pomo tapa olla p. Robust	Bouton de couvercle	Robust pressure cooker knob	22,50
20820	20803	Pomo de puente	Pont bouton	Bridge knob	5,40
20820	20805	Val.coccion o.p.Robust con chimenea	Valve de cuisson Robust	Cooking valve Robust	55,95
20820	20806	Valv.desvap.olla p.	Valve pour ouverture Robust	Robust unvaporization valve	31,35
20820	20811	Junta goma o.p.peq.	Petit joint de caoutchouc	Rubber for small lid	71,75
20820	20817	Puente acero o.p. p.	Petit pont acier	Small st.st.bridge	54,45
20820	20818	Asa costado pequena para olla p.Robust	Anse du corp pour Robust petit	Handle for body Robust small	6,10
20820	20836	Tapa olla Robust pequena	Couvercle cocotte p. petite Robust	Lid for pressure cooker Robust small	206,45
20820	20837	Rejilla Robust pequena	Grille perforee Robust petite	Perforated piece small Robust	24,95
20820	R20805	Pasador corto o.p.Robust	Petite goupille autocuiseur Robust	Robust pressure cooker short pin	5,50
20820	R20806	Arandela elastica o.p.Robust	Rondelle elastique autocuiseur Robust	Robust pressure cooker plastic washer	1,10
20830	20801	Junta goma o.p. med.	Moyen joint de caoutchouc	Rubber for medium lid	87,80
20830	20802	Pomo tapa olla p. Robust	Bouton de couvercle	Robust pressure cooker knob	22,50
20830	20803	Pomo de puente	Pont bouton	Bridge knob	5,40
20830	20805	Val.coccion o.p.Robust con chimenea	Valve de cuisson Robust	Cooking valve Robust	55,95
20830	20806	Valv.desvap.olla p.	Valve pour ouverture Robust	Robust unvaporization valve	31,35
20830	20807	Puente acero o.p. m.	Moyen pont acier	Medium st.st.bridge	60,35
20830	20808	Asa costado o.p.Robust mediana/grande	Anse du corp pour Robust m/g	handle for body Robust m/b	7,65
20830	20832	Tapa olla Robust mediana	Couvercle cocotte p. moyenne Robust	Lid for pressure cooker Robust medium	243,60
20830	20833	Rejilla Robust mediana	Grille perforee Robust moyenne	Perforated piece medium Robust	131,45
20830	R20805	Pasador corto o.p.Robust	Petite goupille autocuiseur Robust	Robust pressure cooker short pin	5,50
20830	R20806	Arandela elastica o.p.Robust	Rondelle elastique autocuiseur Robust	Robust pressure cooker plastic washer	1,10
20830	20819	Chimenea olla presion robust 30-40-50	Cheminée valve de cuisson.cocotte robust	Robust pressure cooker chimney valve	4,90
20830	20822	Tornillo gas 1/2" tapa olla robust	Vis gaz1/2" pour couver.coot.pre.robust	Robust alum-press.cook.lid bolt gas 1/2"	14,55
20830	20838	Tornillo gas 1/4" tapa olla robust	Vis gaz1/4" pour couver.coot.pre.robust	Robust pressure cooker lid gas bolt 1/4"	10,70
20830	20814	Esparrago pomo olla pres.robust.30-40-50	Tourillon poignee couvercle autocuis.gra	Stud for medium/large robust p.c.lid kob	12,80
20840	20801	Junta goma o.p. med.	Moyen joint de caoutchouc	Rubber for medium lid	87,80
20840	20802	Pomo tapa olla p. Robust	Bouton de couvercle	Robust pressure cooker knob	22,50
20840	20803	Pomo de puente	Pont bouton	Bridge knob	5,40
20840	20805	Val.coccion o.p.Robust con chimenea	Valve de cuisson Robust	Cooking valve Robust	55,95
20840	20806	Valv.desvap.olla p.	Valve pour ouverture Robust	Robust unvaporization valve	31,35
20840	20807	Puente acero o.p. m.	Moyen pont acier	Medium st.st.bridge	60,35
20840	20808	Asa costado o.p.Robust mediana/grande	Anse du corp pour Robust m/g	handle for body Robust m/b	7,65
20840	20832	Tapa olla Robust mediana	Couvercle cocotte p. moyenne Robust	Lid for pressure cooker Robust medium	243,60
20840	20833	Rejilla Robust mediana	Grille perforee Robust moyenne	Perforated piece medium Robust	131,45
20840	R20805	Pasador corto o.p.Robust	Petite goupille autocuiseur Robust	Robust pressure cooker short pin	5,50



Ref.	Repuesto	Descripción	Description	Description	€
20840	R20806	Arandela elastica o.p.Robust	Rondelle elastique autocuiseur Robust	Robust pressure cooker plastic washer	1,10
20840	20819	Chimenea olla presion robust 30-40-50	Cheminée valve de cuisson cocotte robust	Robust pressure cooker chimney valve	4,90
20840	20822	Tornillo gas 1/2" tapa olla robust	Vis gaz1/2" pour couvrir.coot.pre.robust	Robust alum-press.cook.lid bolt gas 1/2"	14,55
20840	20838	Tornillo gas 1/4" tapa olla robust	Vis gaz1/4" pour couvrir.coot.pre.robust	Robust pressure cooker lid gas bolt 1/4"	10,70
20840	20814	Esparrago pomo olla pres.robust.30-40-50	Tourillon poignee couvercle autocuis.gra	Stud for medium/large robust p.c.lid kob	12,80
20850	20801	Junta goma o.p. med.	Moyen joint de caoutchouc	Rubber for medium lid	87,80
20850	20802	Pomo tapa olla p. Robust	Bouton de couvercle	Robust pressure cooker knob	22,50
20850	20803	Pomo de puente	Pont bouton	Bridge knob	5,40
20850	20805	Val.coccion o.p.Robust con chimenea	Valve de cuisson Robust	Cooking valve Robust	55,95
20850	20806	Valv.desvap.olla p.	Valve pour ouverture Robust	Robust unvaporization valve	31,35
20850	20807	Puente acero o.p. m.	Moyen pont acier	Medium st.st.bridge	60,35
20850	20808	Asa costado o.p.Robust mediana/grande	Anse du corp pour Robust m/g	handle for body Robust m/b	7,65
20850	20832	Tapa olla Robust mediana	Couvercle cocotte p. moyenne Robust	lid for pressure cooker Robust medium	243,60
20850	20833	Rejilla Robust mediana	Grille perforee Robust moyenne	Perforated piece medium Robust	131,45
20850	R20805	Pasador corto o.p.Robust	Petite goupille autocuiseur Robust	Robust pressure cooker short pin	5,50
20850	R20806	Arandela elastica o.p.Robust	Rondelle elastique autocuiseur Robust	Robust pressure cooker plastic washer	1,10
20850	20819	Chimenea olla presion robust 30-40-50	Cheminée valve de cuisson cocotte robust	Robust pressure cooker chimney valve	4,90
20850	20822	Tornillo gas 1/2" tapa olla robust	Vis gaz1/2" pour couvrir.coot.pre.robust	Robust alum-press.cook.lid bolt gas 1/2"	14,55
20850	20838	Tornillo gas 1/4" tapa olla robust	Vis gaz1/4" pour couvrir.coot.pre.robust	Robust pressure cooker lid gas bolt 1/4"	10,70
20850	20814	Esparrago pomo olla pres.robust.30-40-50	Tourillon poignee couvercle autocuis.gra	Stud for medium/large robust p.c.lid kob	12,80
20880	20802	Pomo tapa olla p. Robust	Bouton de couvercle	Robust pressure cooker knob	22,50
20880	20803	Pomo de puente	Pont bouton	Bridge knob	5,40
20880	20805	Val.coccion o.p.Robust con chimenea	Valve de cuisson Robust	Cooking valve Robust	55,95
20880	20806	Valv.desvap.olla p.	Valve pour ouverture Robust	Robust unvaporization valve	31,35
20880	20808	Asa costado o.p.Robust mediana/grande	Anse du corp pour Robust m/g	handle for body Robust m/b	7,65
20880	20821	Junta goma o.p.gran.	Grad joint de caoutchouc	Rubber for lid pressure cooker big	163,50
20880	20827	Puente acero o.p. g.	Grand pont acier	Big st.st.bridge	115,40
20880	20835	Rejilla Robust grande	Grille perforee Robust grande	Perforated piece big Robust	67,55
20880	R20804	Pasador largo o.p.Robust	Grande goupille autocuiseur Robust	Robust pressure cooker long pin	6,10
20880	R20806	Arandela elastica o.p.Robust	Rondelle elastique autocuiseur Robust	Robust pressure cooker plastic washer	1,10
20880	R20834	Pomo extra tapa 20834	Extra bouton pour 20834	Extra knob for 20834	5,20
21810	20805	Val.coccion o.p.Robust con chimenea	Valve de cuisson Robust	Cooking valve Robust	55,95
21810	20806	Valv.desvap.olla p.	Valve pour ouverture Robust	Robust unvaporization valve	31,35
21810	21808	Asa costado para olla semi-Robust	Anse cocote a presion semi-Robust	Side handle semi-Robust pressure cooker	8,45
21810	21811	Junta goma olla p.semi-Robust	Joint en c.	Rubber for lid semi Robust	108,05
21810	21812	Valvula seg.o.p.semi-Robust	Valve de securite semi-Robust	Safety valve semi Robust	30,00
21810	21816	Pomo tapa olla presion semi-Robust	Bouton couvercle cocotte semi-Robust	Knob for lid semi-Robust	9,25
21810	21831	Rejilla para olla semi-Robust	Grillage pour cocotte semi-Robust	Grill for semi-Robust	21,55
21815	20805	Val.coccion o.p.Robust con chimenea	Valve de cuisson Robust	Cooking valve Robust	55,95
21815	20806	Valv.desvap.olla p.	Valve pour ouverture Robust	Robust unvaporization valve	31,35
21815	21808	Asa costado para olla semi-Robust	Anse cocote a presion semi-Robust	Side handle semi-Robust pressure cooker	8,45
21815	21811	Junta goma olla p.semi-Robust	Joint en c.	Rubber for lid semi Robust	108,05
21815	21812	Valvula seg.o.p.semi-Robust	Valve de securite semi-Robust	Safety valve semi Robust	30,00
21815	21816	Pomo tapa olla presion semi-Robust	Bouton couvercle cocotte semi-Robust	Knob for lid semi-Robust	9,25
21815	21831	Rejilla para olla semi-Robust	Grillage pour cocotte semi-Robust	Grill for semi-Robust	21,55
21820	20805	Val.coccion o.p.Robust con chimenea	Valve de cuisson Robust	Cooking valve Robust	55,95
21820	20806	Valv.desvap.olla p.	Valve pour ouverture Robust	Robust unvaporization valve	31,35
21820	21808	Asa costado para olla semi-Robust	Anse cocote a presion semi-Robust	Side handle semi-Robust pressure cooker	8,45
21820	21811	Junta goma olla p.semi-Robust	Joint en c.	Rubber for lid semi Robust	108,05
21820	21812	Valvula seg.o.p.semi-Robust	Valve de securite semi-Robust	Safety valve semi Robust	30,00
21820	21816	Pomo tapa olla presion semi-Robust	Bouton couvercle cocotte semi-Robust	Knob for lid semi-Robust	9,25
21820	21831	Rejilla para olla semi-Robust	Grillage pour cocotte semi-Robust	Grill for semi-Robust	21,55
21825	20805	Val.coccion o.p.Robust con chimenea	Valve de cuisson Robust	Cooking valve Robust	55,95
21825	20806	Valv.desvap.olla p.	Valve pour ouverture Robust	Robust unvaporization valve	31,35
21825	21808	Asa costado para olla semi-Robust	Anse cocote a presion semi-Robust	Side handle semi-Robust pressure cooker	8,45
21825	21811	Junta goma olla p.semi-Robust	Joint en c.	Rubber for lid semi Robust	108,05
21825	21812	Valvula seg.o.p.semi-Robust	Valve de securite semi-Robust	Safety valve semi Robust	30,00
21825	21816	Pomo tapa olla presion semi-Robust	Bouton couvercle cocotte semi-Robust	Knob for lid semi-Robust	9,25
21825	21831	Rejilla para olla semi-Robust	Grillage pour cocotte semi-Robust	Grill for semi-Robust	21,55
24137	R24137A	Mango crepera + wok eco piedra	Poigne pour eco-piedra crepeire + wok	Handle for eco-piedra crepre maker + wok	4,00
24820	R24820A	Mango sarten CAPRI d.20-22 cms	Poigne poêle aluminium CAPRI d.20-22cm	longhandle frypan CAPRI d.20-22 cm	1,65
24822	R24820A	Mango sarten CAPRI d.20-22 cms	Poigne poêle aluminium CAPRI d.20-22cm	longhandle frypan CAPRI d.20-22 cm	1,65
24824	R24824A	Mango sarten CAPRI d.24-26-28-32 cms	Poigne poêle alumini.CAPRI d.24-26-28-32	longhandle frypan CAPRI d.24-26-28-32 cm	1,65
24826	R24824A	Mango sarten CAPRI d.24-26-28-32 cms	Poigne poêle alumini.CAPRI d.24-26-28-32	longhandle frypan CAPRI d.24-26-28-32 cm	1,65
24828	R24824A	Mango sarten CAPRI d.24-26-28-32 cms	Poigne poêle alumini.CAPRI d.24-26-28-32	longhandle frypan CAPRI d.24-26-28-32 cm	1,65
24832	R24824A	Mango sarten CAPRI d.24-26-28-32 cms	Poigne poêle alumini.CAPRI d.24-26-28-32	longhandle frypan CAPRI d.24-26-28-32 cm	1,65
24918	R24918A	Mango sarten loft d.18-20-22 cms	Poigne poêle aluminium loft d.18-20-22cm	longhandle frypan loft d.18-20-22 cm	1,55
24924	R24924A	Mango sarten loft d.24-26-28 cms	Poigne poêle aluminium loft d.24-26-28cm	longhandle frypan loft d.24-26-28 cm	1,85
25218	R25218A	Mango bicolor verde sarten 25218-20-22cm	Poigne bicolour poêle 25218-20-22 cms	Black+gree frypan longhandle 25218-20-22	6,10
25220	R25218A	Mango bicolor verde sarten 25218-20-22cm	Poigne bicolour poêle 25218-20-22 cms	Black+gree frypan longhandle 25218-20-22	6,10
25222	R25218A	Mango bicolor verde sarten 25218-20-22cm	Poigne bicolour poêle 25218-20-22 cms	Black+gree frypan longhandle 25218-20-22	6,10
25224	R25224A	Mango bicolor sarten 25224-26-28-32cm	Poigne bicolour poêle 25224-26-28-32 cm	Black+gree frypan longhandle 25224-26-28	6,40
25226	R25224A	Mango bicolor sarten 25224-26-28-32cm	Poigne bicolour poêle 25224-26-28-32 cm	Black+gree frypan longhandle 25224-26-28	6,40
25228	R25224A	Mango bicolor sarten 25224-26-28-32cm	Poigne bicolour poêle 25224-26-28-32 cm	Black+gree frypan longhandle 25224-26-28	6,40
25232	R25224A	Mango bicolor sarten 25224-26-28-32cm	Poigne bicolour poêle 25224-26-28-32 cm	Black+gree frypan longhandle 25224-26-28	6,40
25318	R25318A	Mango bicolor sarten 25318-20-22 cm	Poigne bicolour poêle 25318-20-22 cms	Black+grey frypan longhandle 25318-20-22	6,10
25320	R25318A	Mango bicolor sarten 25318-20-22 cm	Poigne bicolour poêle 25318-20-22 cms	Black+grey frypan longhandle 25318-20-22	6,10
25322	R25318A	Mango bicolor sarten 25318-20-22 cm	Poigne bicolour poêle 25318-20-22 cms	Black+grey frypan longhandle 25318-20-22	6,10
25324	R25324A	Mango bicolor sarten 25324-26-28-32 cm	Poigne bicolour poêle 25324-26-28-32 cm	Black+grey frypan longhandle 25324-26-28	6,40

Ref.	Repuesto	Descripción	Description	Description	€	
25326	R25324A	Mango bicolor sarten 25324-26-28-32 cm	Poigne bicolour poêle 25324-26-28-32 cm	Black+grey frypan longhandle 25324-26-28	6,40	
25328	R25324A	Mango bicolor sarten 25324-26-28-32 cm	Poigne bicolour poêle 25324-26-28-32 cm	Black+grey frypan longhandle 25324-26-28	6,40	
25332	R25324A	Mango bicolor sarten 25324-26-28-32 cm	Poigne bicolour poêle 25324-26-28-32 cm	Black+grey frypan longhandle 25324-26-28	6,40	
25420	R25420A	Mango sarten alum.fundido blanca 20-24cm	Poigne poêle alum.fondu induc.20-24 cms	onghand.white cast alum.frypan 20-24 cm	5,60	
25424	R25420A	Mango sarten alum.fundido blanca 20-24cm	Poigne poêle alum.fondu induc.20-24 cms	onghand.white cast alum.frypan 20-24 cm	5,60	
25428	R25428A	Mango sarten alum.fund. blanca 26-28	Poigne poêle alum.fondu induction 28 cms	onghandle white cast alum.frypan 28 cm	6,70	
25520	R25520A	Mango sarten alum.fund.induc.20cm	Poêle aluminium fondu induction d.20 cm	Cast alum.induct.frypan longhandle 20cm	1,55	
25524	R25524A	Mango sarten alum.fund.induc.24-28cm	Poêle aluminium fondu induction d.24-28	Cast alum.induct.frypan longhandle 24-28	1,85	
25528	R25524A	Mango sarten alum.fund.induc.24-28cm	Poêle aluminium fondu induction d.24-28	Cast alum.induct.frypan longhandle 24-28	1,85	
25536	R25536A	Protecc.silicona 2 pcs placa grill 25536	Moufflette en silicone 2 pcs grill 25536	2 pcs silic.protec.for grill plate 25536	3,35	
25547	R25547A	Protecc.silicona 2 pcs placa grill 25547	Moufflette en silicone 2 pcs grill 25547	2 pcs silic.protec.for grill plate 25547	5,00	
25816	R25816A	Tapa cristal d.16 cm cacerola fund. alum	Couverc.verre d.16 cm faitout alum.fondu	Glass lid d.16 cm cast alum.rd.casserole	3,85	
25816	R25816B	Pomo tapa cristal cacer.fundicion alumin	Bouton couvercle verre faitout alum.fond	Square glass lid knob cast alum.casserol	1,10	
25820	R25816B	Pomo tapa cristal cacer.fundicion alumin	Bouton couvercle verre faitout alum.fond	Square glass lid knob cast alum.casserol	1,10	
25820	R25820A	Tapa cristal d.20 cm cacerola fund. alum	Couverc.verre d.20cm faitout alum. fondu	Glass lid d.20 cm cast alum.rd.casserole	4,50	
25821	R25821A	Tapa cristal cuadr.d.20 cm cac.fund.alum	Couverc.verre carré d.16cm fait.alum fond	Square glass lid d.20 cm cast alum.casse	6,70	
25824	R25816B	Pomo tapa cristal cacer.fundicion alumin	Bouton couvercle verre faitout alum.fond	Square glass lid knob cast alum.casserol	1,10	
25824	R25824A	Tapa cristal d.24 cm cacerola fund. alum	Couverc. verre d.24cm faitout alum.fondu	Glass lid d.24 cm cast alum.rd.casserole	5,60	
25825	R25825A	Tapa cristal cuadr.d.24 cm cac.fund.alum	Couverc.verre carré d.16cm faito.alum fon	Square glass lid d.24 cm cast alum.casse	7,75	
25828	R25816B	Pomo tapa cristal cacer.fundicion alumin	Bouton couvercle verre faitout alum.fond	Square glass lid knob cast alum.casserol	1,10	
25828	R25828A	Tapa cristal d.28 cm cacerola fund. alum	Couvercle verre d.28 faitout alum.fondu	Glass lid d.28 cm cast alum.rd.casserole	5,60	
25829	R25829A	Tapa cristal cuadr.d.28 cm cac.fund.alum	Couverc.verre carré d.28 faito.alum.fondu	Square glass lid d.28 cm cast alum.casse	8,95	
25831	R25831A	Tapa cristal d.30 cm cacerola fund.alum	Couverc.verre d.30 cm faitout alum.fondu	Glass lid d.30 cm cast alum.rd.casserole	8,75	
25832	R25832A	Tapa cristal d.32 cm cacerola fund. Alum	Couvercle verre d.32 faitout alum.fondu	Glass lid d.32 cm cast alum.rd.casserole	12,20	
25835	R25835A	Tapa cristal d.36 cm cacerola fund. Alum	Couvercle verre d.36 faitout alum.fondu	Glass lid d.36 cm cast alum.rd.casserole	15,05	
25871	R25871A	Base cacerola hierro fund.MAGMA d.12 cm	Tableau en bois plat rond MAGMA d.12cm	Iron die cast MAGMA cass.wood base d.12	3,05	
25872	R25872A	Base cacerola hierro fund.MAGMA d.15 cm	Tableau en bois pour plat rond MAGMA d15	Iron die cast MAGMA cass.wood base d.15	3,75	
25873	R25873A	Base cacerola hierro fundido magma d18cm	Tableau bois pour plat rond magma d.18cm	Wood base cast iron magma casserole d.18	4,05	
25881	R25881A	Base cacerola hierro fund.MAGMA 15x10 cm	Tableau en bois pour plat oval MAGMA 15x	Wood base iron die cast MAGMA cass.15x10	2,75	
25882	R25882A	Base cacerola hierro fund.MAGMA 17x12	Tableau en bois pour plat oval MAGMA 17x	Wood base iron die cast MAGMA cass.17x12	3,35	
25883	R25883A	Base cacerola hierro fund.magma 21.7x15	Tableau bois pour plat oval magma 21.x15	Wood base cast iron magma cass.21.7x15	4,05	
25909	R25909A	Pomo tapa cacerola alumin.fundido mini	Bouton pour couvercle rouge alum.fondu	Cast aluminium red casserole lid knob	5,00	
25916	R25916A	Tapa cacerola roja alumin.fund. d.16 cms	Couverc.rouge faitout alum.fondu d.16 cm	Cast aluminium red casserole lid d.16 cm	26,15	
25916	R25916B	Pomo tapa cacerola roja alumin.fundido	Bouton pour couvercle rouge alum.fondu	Cast aluminium red casserole lid knob	7,20	
25920	R25916B	Pomo tapa cacerola roja alumin.fundido	Bouton pour couvercle rouge alum.fondu	Cast aluminium red casserole lid knob	7,20	
25920	R25920A	Tapa cacerola roja alumin.fund. d.20 cms	Couvercle faitout rouge alum. fondu.20cm	Cast aluminium red casserole lid d.20 cm	24,40	
25921	R25921C	3 pcs protector silicona cacerola redond	3 pcs silicone protection faitout rond	3pcs silicone protect.round casseroles	6,80	
25921	R25921G	3 pcs protector silico.cacerola red.gris	3 pcs silicone protect.faitout rond gris	3pcs grey silicone protect.round casser.	6,10	
25924	R25916B	Pomo tapa cacerola roja alumin.fundido	Bouton pour couvercle rouge alum.fondu	Cast aluminium red casserole lid knob	7,20	
25924	R25924A	Tapa cacerola roja alumin.fund. d.24 cms	Couvercle faitout rouge alum. fondu 24cm	Cast aluminium red casserole lid d.24 cm	27,90	
25927	R25916B	Pomo tapa cacerola roja alumin.fundido	Bouton pour couvercle rouge alum.fondu	Cast aluminium red casserole lid knob	7,20	
25927	R25927A	Tapa oval cacerola roja alum.fund.26x20	Couverc.ovale rouge alum.fondu d.26x20cm	Cast alum.red casserole oval lid 26x20cm	27,90	
25928	R25916B	Pomo tapa cacerola roja alumin.fundido	Bouton pour couvercle rouge alum.fondu	Cast aluminium red casserole lid knob	7,20	
25928	R25928A	Tapa cacerola roja alumin.fund. d.28 cms	Couverc. faitout rouge alum.fondu d.28 cm	Cast aluminium red casserole lid d.28 cm	34,50	
25931	R25916B	Pomo tapa cacerola roja alumin.fundido	Bouton pour couvercle rouge alum.fondu	Cast aluminium red casserole lid knob	7,20	
25931	R25931A	Tapa oval cacerola roja alum.fund.31x25	Couverc.ov.faitout rouge alum.fondu 31x25	Cast alum.red casserole oval lid 31x25cm	35,50	
25935	R25935C	3 pcs proteccion silicona cacerola oval	3 pcs silicone protections faitout ovale	3pcs silicone protect.oval casseroles	6,80	
25935	R25935G	3 pcs protecc.silicon.cacerola oval gris	3pcs silicone protect.faitout ovale gris	3pcs silicone protect.oval casserol.grey	6,10	
27218	R27218A	Mango bicolor gris sarten 27218-20-22 cm	Poigne bicolour poêle 27218-20-22 cms	Black+grey frypan longhandle 27218-20-22	6,10	
27220	R27218A	Mango bicolor gris sarten 27218-20-22 cm	Poigne bicolour poêle 27218-20-22 cms	Black+grey frypan longhandle 27218-20-22	6,10	
27222	R27218A	Mango bicolor gris sarten 27218-20-22 cm	Poigne bicolour poêle 27218-20-22 cms	Black+grey frypan longhandle 27218-20-22	6,10	
27224	R27224A	Mango bicolor sarten 27224-26-28-32 cm	Poigne bicolour poêle 27224-26-28-32 cm	Black+grey frypan longhandle 27224-26-28	6,40	
27226	R27224A	Mango bicolor sarten 27224-26-28-32 cm	Poigne bicolour poêle 27224-26-28-32 cm	Black+grey frypan longhandle 27224-26-28	6,40	
27228	R27224A	Mango bicolor sarten 27224-26-28-32 cm	Poigne bicolour poêle 27224-26-28-32 cm	Black+grey frypan longhandle 27224-26-28	6,40	
27232	R27224A	Mango bicolor sarten 27224-26-28-32 cm	Poigne bicolour poêle 27224-26-28-32 cm	Black+grey frypan longhandle 27224-26-28	6,40	
27320	R27320B	Pomo tapa stilo d.20-24-28 cms	Manette couvercle stilo d.20-24-28 cm	Stilo spare part lid knob d.20-24-28 cm	2,15	
	39012	R39012A	1 ampara armarios esterilizadores 10-20	1 ampe pour 39012/39124	1 amp for 39012/39124	58,40
	39012	R39012B	Temporizador armario esteril. cuchillos	Minuterie pour armoire à stériliser	Knife sterilizing cupboard timer	14,45
	39012	R39012D	Micro interruptor esterilizad. 39012-124	Micro interrupteur pour 39012-124	39012-124 sterilizer micro switch	5,60
	39120	R39120A	1 ampara matamosquitos electrico 10w	1 ampe anti-moustiques électrique 10 w	10w electric moskitos killer lamp	3,15
	39120	R39120B	Bandeja matamosquitos elec. 20w 18/10	Plateaua anti-moustiques électrique 20w	1810 20w electric moskitos killer tray	3,55
	39120	R39120C	Set cadena+2aros matamosq elect. 20-30w	Set chaîne+2anneaux anti-moustiques élec	20-30w elec. moskito killer set chain+ri	0,80
	39120	R39120D	Mando distancia matamosquitos electrico	Télécommande anti-moustiques électrique	Electric moskito killer remote control	7,10
	39120	R39120E	Transformador mata mosquitos elec.	Transformator appareil anti-moustiques	Electric moskito killer transformer	8,75
	39120	R39120F	Acumulador mata mosquitos electrico 20w	Accumulateur appareil anti-moustiques 20	20w accumulator for moskito killer	6,10
	39120	R39120G	Cebador mata mosquitos electrico 20w	Gueulard elect.appareil anti-moustiques	Electrical moskito killer ballast	1,85
						0,00
						0,00
	39124	R39012A	1 ampara armarios esterilizadores 10-20	1 ampe pour 39012/39124	1 amp for 39012/39124	58,40
	39124	R39012B	Temporizador armario esteril. cuchillos	Minuterie pour armoire à stériliser	Knife sterilizing cupboard timer	14,45
	39124	R39012D	Micro interruptor esterilizad. 39012-124	Micro interrupteur pour 39012-124	39012-124 sterilizer micro switch	5,60
	39128	R39128B	Bandeja recoge mosquitos para 69128	Plateau de mosquitos pour 69128	Mosquitoes try for 69128	2,95
	39128	R39137A	Bombilla ultravioleta 11w	Ampoule uv 11w	11w ultraviolet lamp	14,45
						0,00
						0,00
	39130	R39120C	Set cadena+2aros matamosq elect. 20-30w	Set chaîne+2anneaux anti-moustiques élec	20-30w elec. moskito killer set chain+ri	0,80
	39130	R39120D	Mando distancia matamosquitos electrico	Télécommande anti-moustiques électrique	Electric moskito killer remote control	7,10
	39130	R39120E	Transformador mata mosquitos elec.	Transformator appareil anti-moustiques	Electric moskito killer transformer	8,75
	39130	R39130A	1 ampara matamosquitos electrico 15w	1 ampe anti-moustiques électrique 15 w	15 w electric moskito killer lamp	3,45
	39130	R39130B	Bandeja matamosquitos elec. 30w 18/10	Plateau anti-moustiques élec. 30 w 18/10	18/10 st.st. 30w elec. mosquitos killer	5,00
	39130	R39130C	Transformador para 39130	Transformateur pour 39130	Transformer for 39130	14,35



Ref.	Repuesto	Descripción	Description	Description	€
39130	R39130F	Acumulador mata mosquitos electrico 30w	Accumulateur appareil anti-moustiques 30	30w accumulator for moskito killer 30w	6,10
39130	R39130G	Cebador mata mosquitos eléctrico 30w	Gueulard elec.appare.anti-moustiq.30w	Electrical moskito killer starter 30w	1,40
	39137	R39137A Bombilla ultravioleta 11w	Ampoule uv 11w	11w ultraviolet lamp	14,45
39137	R39137B	Bandeja recoge mosquitos para 69137	Plateau de mosquites pour 69137	Mosquitoes try for 69137	2,95
39138	R39138A	Bombilla ultravioleta 4w	Ampoule uv 4w	4w ultraviolet lamp	2,65
39139	R39139A	Bombilla ultravioleta 6w	Ampoule uv 6w	6w ultraviolet lamp	3,15
	39140	R39140A Alimentador + cadenas + paño 69140-60	Chargeur+chaîne+tissu pour 69140-60	Power supply+chain+cloth for 69140-60	16,40
39140	R39140B	Set 2 cadenas para pizarra 39140-60	2 chaîne set pour 39140-60	2 chains set for 39140-60	6,70
39140	R39140D	Mando de control nuevo para 69140-60	Manette de commande nouveau pour 69140-60	New control button for 69140-60	6,60
39160	R39140A	Alimentador + cadenas + paño 69140-60	Chargeur+chaîne+tissu pour 69140-60	Power supply+chain+cloth for 69140-60	16,40
39160	R39140B	Set 2 cadenas para pizarra 39140-60	2 chaîne set pour 39140-60	2 chains set for 39140-60	6,70
					0,00
					0,00
	39162	R39164A Borrador + set tizas pizarra menu	Effaceur + craie set pour menu ardoise	Eraser + chalk set for menu blackboard	2,35
39163	R39164A	Borrador + set tizas pizarra menu	Effaceur + craie set pour menu ardoise	Eraser + chalk set for menu blackboard	2,35
39164	R39164A	Borrador + set tizas pizarra menu	Effaceur + craie set pour menu ardoise	Eraser + chalk set for menu blackboard	2,35
39166	R39164A	Borrador + set tizas pizarra menu	Effaceur + craie set pour menu ardoise	Eraser + chalk set for menu blackboard	2,35
39165	R39165A	Tirantes delantal malla metalica	Bretelles pour maille chaîne 80x60 cm	Stainless steel chain mesh apron braces	11,00
	39208	R39208A Funda cuchillo ceramico 8 cms	Étui pour couteau céramique 8 cm	8 cms ceramic knife shealth	0,90
39210	R39210A	Funda cuchillo ceramico 10 cms	Étui pour couteau céramique 10 cm	10 cms ceramic knife shealth	0,90
39212	R39212A	Funda cuchillo ceramico 12 cms	Étui pour couteau céramique 12 cm	12 cms ceramic knife shealth	1,10
39213	R39213A	Funda cuchillo ceramico santoku 12 cms	Étui pour couteau céramique santoku 12cm	12 cms ceramic santoku knife shealth	1,10
39215	R39215A	Funda cuchillo ceramico 15 cms	Étui pour couteau céramique 15 cm	15 cms ceramic knife shealth	1,10
39218	R39218A	Funda cuchillo ceramico 18 cms	Étui pour couteau céramique 18 cm	18 cms ceramic knife shealth	1,10
40912	R40002	Pomo + arandela tapa vitrocor	Bouton de couvercle vitrocor	Knob for lid vitrocor	2,55
40914	R40002	Pomo + arandela tapa vitrocor	Bouton de couvercle vitrocor	Knob for lid vitrocor	2,55
40916	R40002	Pomo + arandela tapa vitrocor	Bouton de couvercle vitrocor	Knob for lid vitrocor	2,55
40920	R40002	Pomo + arandela tapa vitrocor	Bouton de couvercle vitrocor	Knob for lid vitrocor	2,55
40922	R40002	Pomo + arandela tapa vitrocor	Bouton de couvercle vitrocor	Knob for lid vitrocor	2,55
40924	R40002	Pomo + arandela tapa vitrocor	Bouton de couvercle vitrocor	Knob for lid vitrocor	2,55
40926	R40002	Pomo + arandela tapa vitrocor	Bouton de couvercle vitrocor	Knob for lid vitrocor	2,55
40928	R40002	Pomo + arandela tapa vitrocor	Bouton de couvercle vitrocor	Knob for lid vitrocor	2,55
40932	R40002	Pomo + arandela tapa vitrocor	Bouton de couvercle vitrocor	Knob for lid vitrocor	2,55
	43016	R43016A Tapa cristal d.16 cms white & black	Couvercle en verre d.16 cm white & black	Glass lid d.16 cms white & black	10,90
43116	R43016A	Tapa cristal d.16 cms white & black	Couvercle en verre d.16 cm white & black	Glass lid d.16 cms white & black	10,90
44016	R43016A	Tapa cristal d.16 cms white & black	Couvercle en verre d.16 cm white & black	Glass lid d.16 cms white & black	10,90
44116	R43016A	Tapa cristal d.16 cms white & black	Couvercle en verre d.16 cm white & black	Glass lid d.16 cms white & black	10,90
43020	R43020A	Tapa cristal d.20 cms white & black	Couvercle en verre d.20 cm white & black	Glass lid d.20 cms white & black	11,60
43120	R43020A	Tapa cristal d.20 cms white & black	Couvercle en verre d.20 cm white & black	Glass lid d.20 cms white & black	11,60
44020	R43020A	Tapa cristal d.20 cms white & black	Couvercle en verre d.20 cm white & black	Glass lid d.20 cms white & black	11,60
44120	R43020A	Tapa cristal d.20 cms white & black	Couvercle en verre d.20 cm white & black	Glass lid d.20 cms white & black	11,60
43024	R43024A	Tapa cristal d.24 cms white & black	Couvercle en verre d.24 cm white & black	Glass lid d.24 cms white & black	12,50
43124	R43024A	Tapa cristal d.24 cms white & black	Couvercle en verre d.24 cm white & black	Glass lid d.24 cms white & black	12,50
43624	R43024A	Tapa cristal d.24 cms white & black	Couvercle en verre d.24 cm white & black	Glass lid d.24 cms white & black	12,50
44024	R43024A	Tapa cristal d.24 cms white & black	Couvercle en verre d.24 cm white & black	Glass lid d.24 cms white & black	12,50
44124	R43024A	Tapa cristal d.24 cms white & black	Couvercle en verre d.24 cm white & black	Glass lid d.24 cms white & black	12,50
44624	R43024A	Tapa cristal d.24 cms white & black	Couvercle en verre d.24 cm white & black	Glass lid d.24 cms white & black	12,50
43028	R43028A	Tapa cristal d.28 cms white & black	Couvercle en verre d.28 cm white & black	Glass lid d.28 cms white & black	14,15
43128	R43028A	Tapa cristal d.28 cms white & black	Couvercle en verre d.28 cm white & black	Glass lid d.28 cms white & black	14,15
43628	R43028A	Tapa cristal d.28 cms white & black	Couvercle en verre d.28 cm white & black	Glass lid d.28 cms white & black	14,15
44028	R43028A	Tapa cristal d.28 cms white & black	Couvercle en verre d.28 cm white & black	Glass lid d.28 cms white & black	14,15
44128	R43028A	Tapa cristal d.28 cms white & black	Couvercle en verre d.28 cm white & black	Glass lid d.28 cms white & black	14,15
44628	R43028A	Tapa cristal d.28 cms white & black	Couvercle en verre d.28 cm white & black	Glass lid d.28 cms white & black	14,15
					0,00
					0,00
50128G	R50128G	Grifo olla g 1/2+ 2 arandelas	Robinet g 1/2" + 2 rondelle	Faucet g 1/2" + 2 washer	18,30
50132G	R50128G	Grifo olla g 1/2+ 2 arandelas	Robinet g 1/2" + 2 rondelle	Faucet g 1/2" + 2 washer	18,30
50136G	R50128G	Grifo olla g 1/2+ 2 arandelas	Robinet g 1/2" + 2 rondelle	Faucet g 1/2" + 2 washer	18,30
50140G	R50128G	Grifo olla g 1/2+ 2 arandelas	Robinet g 1/2" + 2 rondelle	Faucet g 1/2" + 2 washer	18,30
	50815	R50815A Mecanismo de cierre tapa	Système de verouillage du couvercle	locking mechanism for cover	22,30
50815	R50815B	Proteccion negra	Protection noir	Black color plastic cover	13,35
50815	R50815C	Valvula de presion	Valve à pression	Pressure valve	17,80
50815	R50815D	Junta redonda silicona	Joint en silicone	Silicone ring	28,90
50815	R50815E	Valvula de seguridad	Velve de securité	Security valve	9,95
50815	R50815F	Valvula de seguridad secundaria	Valve de secours	Secondary security valve	33,35
50815	R50815G	lave valvula de seguridad	Soupage securite cle ouverte	Security valve open key	6,50
50818	R50815A	Mecanismo de cierre tapa	Système de verouillage du couvercle	locking mechanism for cover	22,30
50818	R50815B	Proteccion negra	Protection noir	Black color plastic cover	13,35
50818	R50815C	Valvula de presion	Valve à pression	Pressure valve	17,80
50818	R50815D	Junta redonda silicona	Joint en silicone	Silicone ring	28,90
50818	R50815E	Valvula de seguridad	Velve de securité	Security valve	9,95
50818	R50815F	Valvula de seguridad secundaria	Valve de secours	Secondary security valve	33,35
50818	R50815G	lave valvula de seguridad	Soupage securite cle ouverte	Security valve open key	6,50
50823	R50815A	Mecanismo de cierre tapa	Système de verouillage du couvercle	locking mechanism for cover	22,30
50823	R50815B	Proteccion negra	Protection noir	Black color plastic cover	13,35



Ref.	Repuesto	Descripción	Description	Description	€
50823	R50815C	Valvula de presion	Valve à pression	Pressure valve	17,80
50823	R50815D	Junta redonda silicona	Joint en silicone	Silicone ring	28,90
50823	R50815E	Valvula de seguridad	Velve de securité	Security valve	9,95
50823	R50815F	Valvula de seguridad secundaria	Valve de secours	Secondary security valve	33,35
50823	R50815G	lave valvula de seguridad	Soupage securite cle ouverte	Security valve open key	6,50
56212	R56212A	Soporte lateral est. tubular 250 mm	Support latéraux étagère tubulaire 250	250 mm. tubular shelf lateral support	13,65
56212	R56212B	Soporte central estant.tubular 250 mm.	Support cémtraux étagère tubulaire 250	250 mm. tubular shelf central support	13,55
56212	R56212C	Barra estante tubular 1200 mm.	Barra pour étagère tubulaire 1200 mm.	1200 mm. tubular shelf tube	7,20
56212	R56212D	Set tornillos estante tubular	Ensemble vis pour étagère tubulaire	Tubular shelf spare bolt+nut+washer set	2,05
56216	R56212A	Soporte lateral est. tubular 250 mm	Support latéraux étagère tubulaire 250	250 mm. tubular shelf lateral support	13,65
56216	R56212B	Soporte central estant.tubular 250 mm.	Support cémtraux étagère tubulaire 250	250 mm. tubular shelf central support	13,55
56216	R56212D	Set tornillos estante tubular	Ensemble vis pour étagère tubulaire	Tubular shelf spare bolt+nut+washer set	2,05
56216	R56216C	Barra estante tubular 1600 mm.	Barre pour étagère tubulaire 1600 mm.	1600 mm. tubular shelf tube	8,75
56218	R56212A	Soporte lateral est. tubular 250 mm	Support latéraux étagère tubulaire 250	250 mm. tubular shelf lateral support	13,65
56218	R56212B	Soporte central estant.tubular 250 mm.	Support cémtraux étagère tubulaire 250	250 mm. tubular shelf central support	13,55
56218	R56212D	Set tornillos estante tubular	Ensemble vis pour étagère tubulaire	Tubular shelf spare bolt+nut+washer set	2,05
56218	R56218C	Barra estante tubular 1800 mm.	Barre pour étagère tubulaire 1800 mm.	1800 mm. tubular shelf tube	9,75
56412	R56212C	Barra estante tubular 1200 mm.	Barra pour étagère tubulaire 1200 mm.	1200 mm. tubular shelf tube	7,20
56412	R56212D	Set tornillos estante tubular	Ensemble vis pour étagère tubulaire	Tubular shelf spare bolt+nut+washer set	2,05
56412	R56412A	Soporte lateral estant. tubular 400 mm.	Support latéraux étagère tubulaire 400	400 mm. tubular shelf lateral support	19,65
56412	R56412B	Soporte central estant. tubular 400 mm.	Support céntraux étagère tubulaire 400	400 mm. tubular shelf central support	19,65
56416	R56212D	Set tornillos estante tubular	Ensemble vis pour étagère tubulaire	Tubular shelf spare bolt+nut+washer set	2,05
56416	R56216C	Barra estante tubular 1600 mm.	Barre pour étagère tubulaire 1600 mm.	1600 mm. tubular shelf tube	8,75
56416	R56412A	Soporte lateral estant. tubular 400 mm.	Support latéraux étagère tubulaire 400	400 mm. tubular shelf lateral support	19,65
56416	R56412B	Soporte central estant. tubular 400 mm.	Support céntraux étagère tubulaire 400	400 mm. tubular shelf central support	19,65
56418	R56212D	Set tornillos estante tubular	Ensemble vis pour étagère tubulaire	Tubular shelf spare bolt+nut+washer set	2,05
56418	R56218C	Barra estante tubular 1800 mm.	Barre pour étagère tubulaire 1800 mm.	1800 mm. tubular shelf tube	9,75
56418	R56412A	Soporte lateral estant. tubular 400 mm.	Support latéraux étagère tubulaire 400	400 mm. tubular shelf lateral support	19,65
56418	R56412B	Soporte central estant. tubular 400 mm.	Support céntraux étagère tubulaire 400	400 mm. tubular shelf central support	19,65
60005	R60005A	Cuchilla cortaquesos	ame pour coupe fromage	Cutting tool for cheese cutter	1,85
60021	R60021C	Conjunto cuchilla pasapures 20 cms.	Ensemble lame de moulin a legume 20 cm.	Spare set of blade for moulin 20 cm.	10,50
60021	R60021F	Disco paso fino pasapures 20 cms.	Grille pas fin pour moulin 20 cm.	Spare sieve small hole for moulin 20 cm.	3,55
60021	R60021G	Disco paso grueso pasapures 20 cms.	Grille pas gros pour moulin 20 cm.	Spare sieve big hole for moulin 20 cm.	3,55
60025	R60025C	Conjunto cuchilla pasapures 25 cms.	Ensemble lame de moulin a legume 25 cm.	Spare set of blade for moulin 25 cm.	19,15
60025	R60025F	Disco paso fino pasapures 25 cms.	Grille pas fin pour moulin 25 cm.	Spare sieve small hole for moulin 25 cm.	5,20
60025	R60025G	Disco paso grueso pasapures 25 cms.	Grille pas gros pour moulin 25 cm.	Spare sieve big hole for moulin 25 cm.	5,20
60025	R60027	Helice pasapures d.24 cms	Bouton presse-purees 25 cms.	D.25 cms. puree sieve knob	2,25
60026	R60026C	Conjunto cuchilla pasapures 26 cms.	Ensemble lame de moulin a legume 26 cm.	Spare set of blade for moulin 26 cm.	22,80
60026	R60026F	Disco paso fino pasapures 26-32cms.	Grille pas fin pour moulin 26-32 cm.	Spare sieve small hole for moulin 26-32	7,55
60026	R60026G	Disco paso grueso pasapures 26-32cms.	Grille pas gros pour moulin 26-32 cm.	Spare sieve big hole for moulin 26-32 cm	7,55
60026	R60031G	Pomo pasapures 26-32 cms.	Poignée pour presse puree 26-32 cm.	Knob for potato mashing machine 26-32 cm	2,05
60027	R60027F	Disco perforado fino pasapures d.24 cms	Disque fine presse-puree d.24 cms	D.24 cm potato mashing machine fine disc	5,60
60027	R60027G	Disco perforado grueso pasapures d.24 cm	Disque épais presse-puree d.24 cms	D24cm potato mashing machine coarse disc	5,60
60027	R60027H	Disco perforado juliana pasapures d.24cm	Disque julienne presse-puree d.24 cms	D24cm potato mashing mach.julienne disc	5,60
60029	R60029C	Conjunto cuchilla pasapures 28 cms.	Ensemble lame de moulin à legume 28 cms.	Spare blade set for vegetable mill 28 cm	9,95
60029	R60029F	Disco paso fino pasapures 28 cms.	Grille pas fin pour moulin 28 cms.	Spare fine sieve disc f/vegetable mill28	2,45
60029	R60029G	Disco paso grueso pasapures 28 cms.	Grille pas gros pour moulin 28 cms.	Spare coarse sieve disc f/vegetable mill	2,45
60029	R60029M	Disco paso medio pasapures 28 cms.	Grille pas moyen pour moulin 28 cms.	Spare medium sieve disc f/vegetable mill	2,45
60030	R60028	Pomo pasapures d.30 cms	Bouton presse-puree 30 cms.	D.30 cms. puree sieve knob	2,15
60030	R60030C	Conjunto cuchilla pasapures 30 cms.	Ensemble lame de moulin a legume 30 cm.	Spare set of blade for moulin 30 cm.	26,35
60030	R60030F	Disco paso fino pasapures 30 cms.	Grille pas fin pour moulin 30 cm.	Spare sieve small hole for moulin 30 cm.	7,20
60030	R60030G	Disco paso grueso pasapures 30 cms.	Grille pas gros pour moulin 30 cm.	Spare sieve big hole for moulin 30 cm.	7,20
60031	R60026F	Disco paso fino pasapures 26-32cms.	Grille pas fin pour moulin 26-32 cm.	Spare sieve small hole for moulin 26-32	7,55
60031	R60026G	Disco paso grueso pasapures 26-32cms.	Grille pas gros pour moulin 26-32 cm.	Spare sieve big hole for moulin 26-32 cm	7,55
60031	R60031C	Conjunto cuchilla pasapures 32 cms.	Ensemble lame de moulin a legume 32 cm.	Spare set of blade for moulin 32 cm.	22,30
60031	R60031G	Pomo pasapures 26-32 cms.	Poignée pour presse puree 26-32 cm.	Knob for potato mashing machine 26-32 cm	2,05
60043	R60043C	Helice pasapures d.13 cms.	Helice presse-puree d.13 cm.	D.13 cm. potato mashing machine helix	10,90
60043	R60043F	Disco perforado pasapures d.13 cms.	Disque perfore presse-puree d.13 cms.	Potato mashing machine perf. disc d.13	1,55
60048	R60048C	Helice pasapures d.18 cms.	Helice presse-puree d.18 cm.	D.18 cm.potato mashing machine helice	11,40
60048	R60048F	Disco perf. fino pasapures d.18 cms.	Disque fine presse-puree d.18 cms.	D.18 cm.potato mashing machine fine disc	1,75
60048	R60048G	Disco perf. grueso pasapures d.18 cms.	Disque épais presse-puree d.18 cms.	18 cm.potato mashing machine coarse disc	1,95
60048	R60048H	Disco perf. juliana pasapures d.18 cms.	Disque julienne presse-puree d.18 cms.	18 cms.potato mashing mach. julien. disc	1,75
60053	R60053A	Jgo 3 discos pasapures plastico d.23 cm	Ensem.3 disques presse puree plast.d23cm	3 disc set for plastic food mill d.23 cm	11,20
60053	R60053B	Helice+cuchill pasapures plastico d.23cm	Ensemble lame moulin à legume plast.23cm	Blade+crank for plastic food mill d.23cm	14,45
60058	R60058A	Jgo 2 discos pasapures plastico d.18 cm	Ensem.2 disques presse puree plast.d18cm	2 disc set for plastic food mill d.18 cm	5,00
60058	R60058B	Helice+cuchill pasapures plastico d.18cm	Ensemble lame moulin a legume plast.18cm	Blade+crank for plastic food mill d.18cm	13,95
60298	R60298A	Virador y tapa	Toner et couverture	Toner and cover	5,10
60298	R60298B	Cuchilla de corte fino	Tambour a dechiqueteuse fine	Fine shredder drum	10,30
60298	R60298C	Cuchilla de corte rebanada	Tambour a trancheuse	Slicer drum	7,75
60298	R60298D	Cuchilla de corte grueso	Tambour a dechiqueteuse grossiere	Coarse shredder drum	8,45
60327	R60327A	Cabezal picadora de hielo manual	Traversin pour broyeur à glace manuel	Bolster for manual ice crusher	14,75
60329	R60329A	Disco corte picadora manual inox 4mm	Disque 4mm. haichoir manuel pour viande	St.steel hand meat mincer slotted disc 4	6,10
60329	R60329B	Disco corte picadora manual inox 5mm	Disque 5mm. haichoir manuel pour viande 5	St.steel hand meat slotted disc 5 mm.	6,10
60329	R60329C	Disco corte picadora manual inox 8 mm.	Disque 8mm.haichoir manuel pour viande in	St. st. hand meat mincer slotted disc 8	6,10
60329	R60329D	Cuchilla corte picadora manual inox	ame haichoir manuel pour viande en inox	St.steel hand meat mincer cutting blade	2,65
60329	R60329E	Tuerca picadora manual inox	Écrou haichoir manuel pour viande en inox	St.steel hand meat mincer nut	5,80
60329	R60329F	Eje espiral para 60329	Axe en spirale pour 60329	Spiral axis for 60329	20,45
60330	R60330A	Repuesto sup.conj.cort.a maniv.	Replacé sup. coupe légumes mécan. 5d.	Up spare part for 5 disc man.veg.slicer	11,70
60330	R60330B	Repuesto inf.conj.cort.a maniv.	Replacé inf.coupe légumes mécan.5d	Down spare part for 5 disc man.veg.slice	9,95
60330	R60330C	Disco corte juliana	Disque de coupes julienne	Slicer disc juliana	2,15
60330	R60330D	Disco corte grueso	Disque de coupes pas gros	Slicer disc big holes	2,15

Ref.	Repuesto	Descripción	Description	Description	€
60330	R60330E	Disco corte medio	Disque de coupes pas medium	Slicer disc medium	2,15
60330	R60330F	Disco corte pequeño	Disque de coupes pas petiti	Slicer disc small	2,15
60330	R60330G	Disco corte rodajas	Disque de coupes tranche	Slicer disc	2,15
60331	R60331	Jgo.cuchillas mand.plástico	Jeu de 5 lames pour mandoline en plastiq	5 spare blades for plastic mandoline	13,15
60332	R60332	Jgo.cuchillas mandolina inox	Jeu de lames pour mandoline en inox luxe	Spare blades for st.steel mandoline	11,40
60332	R60332A	Proteccion mandolina inox luxe	Protection pour mandoline luxe	St.steel luxe mandoline protection	13,15
60332	R60332B	Cuchilla lisa para 60332	Coupe lisa pour 60332	Plain cutter for 60332	2,25
60338	R60338A	Jgo. cuchillas mandolina "v" negro	Jeu de lames pour mandoline en "v"	"v" mandoline spare part blades	13,15
60340	R60340A	Cuerpo, manivela, tuerca pic. man. carne	Corp.manivelle,écrou hachoir avec manv.	Body,handle,nut manual meat mincer	13,75
60340	R60340B	Husillo picadora manual carne	Vis hachoir avec maniv	Screw manual meat mincer	6,00
60340	R60340C	Cuchilla y discos perf. pic. man. carne	l ames & disques p/hachoir a/maniv.	Blades & perf. discs f/manual meat mince	3,85
60341	R60341A	Cuerpo rallador multiple c/contenedor	Corp multi râpe a/bac acrylic	Body multislicer w/container	6,70
60341	R60341B	Contenedor rallador multiple c/cont.	Container multi râpe a/bac acrylic	Container multislicer w/container	2,55
60341	R60341C	Juego 4 cuchillas rallador mul. c/cont.	4 lames multi râpe avec bac acrylic	Set of 4 blades multislicer w/container	3,35
60341	R60341D	Repuesto exprimidor rall. mul. c/cont.	Presse-fruits replacé p/râpe a/bac acril	Squizer spare part f/multislicer w/conta	2,55
60341	R60341E	Protector y manivela rall. mul. c/cont.	Protector & manivelle p/replacé p/multi	Protector & handle f/multislicer w/conta	3,35
60343	R60343A	Repuesto cuchilla corta patata 6x6 mm.	l ame coupe-frites 6x6 mm	Spare part blade chips cutter 6x6	18,10
60343	R60343B	Repuesto cuchilla corta patata 8x8	l ame coupe-frites 8x8 mm	Spare part blade chips cutter 8x8	27,05
60343	R60343C	Repuesto cuchilla corta patatas 10x10	l ame coupe-frites 10x10 mm	Spare part bolts chips cutters 10x10	15,25
60343	R60343D	Repuesto tornillos nylon patatas	Vis pour lame coupe frites	Spare part bolts chips cutters	4,15
60343	R60343E	Bloque empujador nylon corta chips	Poussoir en nylon pour coupe-frites	Nylon pushing part for chips cutter	3,45
60344	R60344A	Cuchilla chips 6 mm+empujador	Coupe frites 6 mm + poussoir	6 mm chips cutter blade + pusher	13,15
60344	R60344B	Cuchilla chips 9 mm+empujador	Coupe frites 9 mm + poussoir	9 mm chips cutter blade + pusher	10,70
60344	R60344C	Cuchilla rodaja chips 6mm + empujador	Coupe rondelles 6 mm + poussoir	6 mm slice blade + pusher	9,95
60356	R60356A	Jgo. cuchillas mandolina "v" gris	Jeu de lames pour mandoline en "v"	Grey "v" mandoline spare part blades	13,15
60356	R60356B	Protector mandolina plastico gris	Protecteur pour mandoline en plastique	Plastic mandoline protector	3,35
60357	R60357B	Protector mandolina inox	Protecteur pour mandoline en inox	St.steel mandoline protector	5,00
60357	R60357C	Maleta plastico mandolina inox	Valisse pour mandoline en inox	St.steel mandoline plastic case	10,30
60357	R60357D	Cuchilla lisa repuesto mandolina inox	l ame fouet pour mandoline en inox	Plain blade for revolving mandoline	6,30
60360	R60360A	Protector mandolina compact	Protecteur mandoline compact	Compact mandoline protectos	2,25
60360	R60360B	Jgo. cuchillas mandolina compact	Jeu de lames mandoline compact	Copact mandoline spare blade set	6,70
60361	R60361A	Cuchilla+batidor mini chopper	l ame+batteur mini chopper	Mini chopper spare blade+beater part set	5,00
60361	R60361B	Set 3 pcs. mini chopper	Ensemble 3 pieces mini chopper	Mini chopper 3 pcs. spare part set	2,75
60362	R60362A	Cuchilla+batidor micro chopper	l ame+batteur micro chopper	Micro chopper blade+beater spare part	3,25
60363	R60363A	Protector mandolina luxe	Protecteur pour mandoline luxe	Protector for luxe mandoline	4,50
60363	R60363B	Jgo. cuchillas mandolina luxe	Jeu de lames pour mandoline luxe	Spare part blade set for luxe mandoline	8,95
60390	R60390A	Cabezal repuesto maq.laminad.pasta 145mm	Tête pièce détachée machine à pâte 145mm	145 mm pasta machine slicer spare head	16,40
60390	R60390B	Manivela+brida maq.laminad.pasta 145 mm	Manivelle+bride p/machine à pâte 145mm	145 mm pasta mach.slicer lever+bracket	5,10
60390	R60390C	Rodillo cortador maq.laminad.pasta 145mm	Rouleau coupeur p/machine à pâte 145mm	145 mm pasta mach.slicer 2 wheel cutter	2,45
60391	R60391A	Cabezal repuesto maq.laminad.pasta 260mm	Tête pièce détachée machine à pâte 260mm	260 mm pasta machine slicer spare head	20,05
60391	R60391B	Manivela+brida maq.laminad.pasta 260 mm	Manivelle+bride p/machine à pâte 260mm	260 mm pasta mach.slicer lever+bracket	5,40
60391	R60391C	Rodillo cortador maq.laminad.pasta 260mm	Rouleau coupeur p/machine à pâte 260mm	260 mm pasta mach.slicer 2 wheel cutter	2,75
60441	R60441A	Cuchilla mandolina corte doble	l ame pour mandoline double coupè	Dual slice mandoline spare blade	4,60
60441	R60441B	Protector mandolina corte doble	Protecteur pour mandoline double coupè	Dual slice mandoline protector	4,40
60447	R60447A	Cuchilla mandolina corte	l ame pour mandoline 60447	60447 slice mandoline spare blade	6,30
60447	R60447B	Protector mandolina corte 60447	Protecteur pour mandoline coupè 60447	60447 slice mandoline protector	7,10
60447	R60447C	Regulador espesor/cuchilla juliana 60447	l ame juliene/regulateur d apisseur 60447	Julienne blade/thickness regulator 60447	5,90
60447	R60447D	Pies goma mandolina 60447	Set 2 pieds en caoutchouc 60447 mandolin	Rubber feet for mandoline 60447	4,90
60510	R60510A	Carro para corta vegetales 60510	Chariot pour legumes trancheuse 60510	Trolley for vegetable slicer 60510	116,30
60510	R60510B	Soporte cuchillas corta vegetales 60510	l ames support legumes trancheuse 60510	Blade support for vegetable slicer 60510	95,15
60510	R60510C	10 cuchillas corta vegetales 60510	10 lames legumes trancheuse 60510	10 blades for vegetable slicer 60510	126,15
60510	R60510D	Pomo carro corta vegetales 60510	Bouton legumes trancheuse 60510	Cart knom for vegetable slicer 60510	135,25
60510	R60510E	Rail de transporte corta vegetales 60510	Titre de transport for 60510	Transport rail vegetable slicer 60510	1,30
60510	R60510F	Set 2 patas corta vegetales 60510	Set 2 pieds legumes trancheuse 60510	2 feet set for vegetable slicer 60510	8,55
60511	R60511A	Bloque empujador para coratdora 60511	Poussoir bloc pour trancheuse 60511	Pusher block for 60511 slicer	40,50
60511	R60511B	Cuchilla corta vegetales 60511	10 lames legumes trancheuse 60511	10 blades for vegetable slicer 60511	42,35
60512	R60512A	Mano para mortero granito 12x8 cms	Pilon pour granit mortier 12x8 cms	Pestle for granite mortar12x8 cms	1,40
60513	R60513A	Cuchilla + empujador 15x15 mm	Poussoir bloc + lame 15x15 mm	Blade + pusher 15x15 mm	34,10
60513	R60513B	Cuchilla + empujador 10x10 mm	Poussoir bloc + lame 10x10 mm	Blade + pusher 10x10 mm	34,10
60513	R60513C	Cuchilla + empujador 7x7 mm	Poussoir bloc + lame 7x7 mm	Blade + pusher 7x7 mm	34,10
60513	R60513D	Cuchilla 8 gajos + empujador	Poussoir bloc + lame 8 cales	8 wedges blade + pusher	38,35
60513	R60513E	Juego tornillos para coratdora 60513	Set assemblage pour trancheuse 60513	Assembly set for 60513 slicer	4,80
60514	R60514A	Mano para mortero granito 14x10 cms	Pilon pour granit mortier 14x10 cms	Pestle for granite mortar14x10 cms	1,40
60516	R60516A	Mano para mortero granito 16x12 cms	Pilon pour granit mortier 16x12 cms	Pestle for granite mortar16x12 cms	1,55
60517	R60517A	Mano para mortero granito d.12x8 cms	Pilon pour granit mortier d.12x8 cms	Pestle for granite mortar d.12x8 cms	5,60
60518	R60518A	Mano para mortero granito d.12x12 cms	Pilon pour granit mortier d.12x12 cms	Pestle for granite mortar d.12x12 cms	5,10
60519	R60519A	Bloque 9 cuchillas para coratdora 60519	9 limes bloc pour trancheuse 60519	9 blade block for 60519 slicer	61,75
60519	R60519B	Bloque 8 cuchillas para coratdora 60519	8 limes bloc pour trancheuse 60519	8 blade block for 60519 slicer	61,75
60519	R60519C	Bloque empujador para coratdora 60519	Poussoir bloc pour trancheuse 60519	Pusher block for 60519 slicer	66,15
60519	R60519D	Juego tornillos para coratdora 60519	Set assemblage pour trancheuse 60519	Assembly set for 60519 slicer	6,40
60519	R60519E	Set 4 pies de goma para coratdora 60519	Set 4 pieds pour trancheuse 60519	4 rubber feet set for 60519 slicer	2,85
60526	R60526A	Bloque empujador para cortador 60526	Bloc poussoir pour 60526	Pusher for the cutter machine 60526	32,65
60526	R60526B	Cuchilla 6 gajos para cortador 60526	6 wedger lame pour 60526	6 wedger blade for cutter machine 60526	46,10
60526	R60526D	3 pies de goma cortador vertical 60526	3 pates en caoutchouc pour 60526	3 rubber feet for 60526	4,40
60701	R60701A	Repto.brazo derc.izd. portarrollos pared	Brass droit gauche pour derouleur de par	Multiroll dispenser spare part right-lef	5,60
60701	R60701B	Repuesto cortante film plastico+aluminio	Ensemble coupant pour film tranp+alum	Spare part cling film+alumin.foil cutter	2,75
60702	R60702B	Repuesto cortante film plastico+aluminio	Ensemble coupant pour film tranp+alum	Spare part cling film+alumin.foil cutter	2,25
60710	R60740	Soporte dcho-izdo y tirafondo colg barra	Ensemble de fixation pour pendiere mural	Wall hager spare part left+right+schraub	6,20
60740	R60740	Soporte dcho-izdo y tirafondo colg barra	Ensemble de fixation pour pendiere mural	Wall hager spare part left+right+schraub	6,20
60760	R60740	Soporte dcho-izdo y tirafondo colg barra	Ensemble de fixation pour pendiere mural	Wall hager spare part left+right+schraub	6,20
61133A	R61133A	Contenedor porta especias 1.000 ml	Boîte blanc porte-épices 1000 ml	White spice box 1000 ml	1,85
61133B	R61133B	Tapa caja porta especias	Couvercle pour boîte porte-épices	Spice box spare part lid	9,45
61133C	R61133B	Tapa caja porta especias	Couvercle pour boîte porte-épices	Spice box spare part lid	9,45

Ref.	Repuesto	Descripción	Description	Description	€
61134	R61134A	Contenedor porta especias 750 ml	Boîte blanc porte-épices 750 ml	White spice box 750 ml	1,65
61135	R61133B	Tapa caja porta especias	Couvercle pour boîte porte-épices	Spice box spare part lid	9,45
61135	R61135A	Contenedor porta especias 600 ml	Boîte blanc porte-épices 600 ml	White spice box 600 ml	1,40
61136	R61133B	Tapa caja porta especias	Couvercle pour boîte porte-épices	Spice box spare part lid	9,45
61136	R61136A	Contenedor porta especias 450 ml	Boîte blanc porte-épices 450 ml	White spice box 450 ml	1,10
61351	R61351A	Cuchilla de laminador de trufa	Lamé pour coupe-truffles inox 18/10	Truffle slicer spare part blade	2,25
61418	R61418A	Aguja jeringa para cocina 60 ml/ 1 oz	Aiguille seringue cuisine 60 ml / 1 oz	Needle kitchen syringe 60 ml / 1 oz	0,90
61420	R61420A	Engranaje+rueda tapa centrif. 12-25 l.	Pignon+roue pour essereuse 12-25 l.	Gear+wheel for salad dryer lid 12-25	36,85
61420	R61420B	Tapa centrifugadora 12 litros	Couvercle pour essereuse a salade 12 l	12 lts salad dryer lid	122,60
61420	R61420C	Cestillo centrifugadora prof. 12 lts.	Panier pour essereuse à salade 12 lts.	Basket for salad spinner drier 12 lts.	28,80
61420	R61420D	Soporte cestillo para 61420	Panier de soutien pour 61420	Support basket for 61420	12,80
61425	R61420A	Engranaje+rueda tapa centrif. 12-25 l.	Pignon+roue pour essereuse 12-25 l.	Gear+wheel for salad dryer lid 12-25	36,85
61425	R61420B	Tapa centrifugadora 12 litros	Couvercle pour essereuse a salade 12 l	12 lts salad dryer lid	122,60
61425	R61425A	Tapa centrifugadora 25 lts	Couvercle pour essereuse à salade 25l	25 lts salad dryer lid	124,95
61425	R61425C	Cestillo centrifugadora prof. 25 lts.	Panier pour essereuse à salade 25 lts.	Basket for salad spinner drier 25 lts.	33,60
61610	R61610A	Tapon jarra separador de grasas	Chapeau pour separateur de graisse	Cap for gravy/fat separator	1,40
61610	R61610B	Filtro jarra separador de grasas	Filtere pour separateur de graisse	Filter for gravy/fat separator	1,90
61670	R61670A	Juego cuchillas batidor elec.BAMIX160w	Couteau ensemble pour hachoir BAMIX 160w	160w BAMIX elec.mixer spare blades set	41,20
61670	R61670B	Soporte pie/pared batidor elec.BAMIX160w	Support pied/murale hachoir BAMIX 160w	160w BAMIX elec.mixer standing/wall supp	8,95
61670	R61670C	Vaso batidor electrico BAMIX classic160w	Verre pour hachoir BAMIX classic 160w	Beaker for 160w BAMIX classic elec.mixer	9,95
61670	R61670D	Motor batidor bamix 160w	Moteur pour bamix mixeur 160w	Motor for bamix 160 w	117,70
61670	R61672A	Cuchilla lisa BAMIX	Disque fouet pour BAMIX	Plain/beater blade for BAMIX mixer	9,85
61670	R61672B	Cuchilla pure BAMIX	Disque à purée pour BAMIX	Purée/whisk blade for BAMIX mixer	9,85
61670	R61672C	Cuchilla multiproposito BAMIX	Couteau à emulsion pour BAMIX	Multipurpose/chopping blade for BAMIX	11,50
61670	R61672D	Cuchilla de carne BAMIX	Couteau standard pour BAMIX	Meat blade for BAMIX mixer	14,65
61671	R61671A	Picadora para batidor+picador elec.700w	mixeur+ hachoir electrique 700w	Elec.stick blender chopper bowl 700w	10,05
61671	R61671B	Cabez.varillas batidor+picador elec.700w	Fouet pour mixeur+ hachoir electrique 7	Elec.stick blender+chopper whisk head 70	11,00
61671	R61671C	Vaso para batidor+picador elec.700w	Verre pour mixeur+ hachoir electrique 7	Elec.stick blender+chopper beaker 700w	2,05
61671	R61671D	Tubo largo batidor+picador elec.700w	Pied pour mixeur+ hachoir electrique 7	Elec.stick blender+chopper long stick 70	20,95
61671	R61671E	Tubo corto batidor+picador elec.700w	Moteur pour mixeur+ hachoir electrique 7	Electric stick blender+chopper stick 700	18,10
61671	R61671F	Sop.pared batidor+picador elec.700w	Support mixeur+ hachoir electrique 7	Elec.stick blender wall mount 700w	0,90
61671	R61671G	Motor batidor+picador elec.700w	Moteur pour mixeur+ hachoir electrique 7	Electric stick blender+chopper motor 700	41,00
61671	R61671H	Conj. cuchillas+llave batidor elec.700w	Moteur pour mixeur+ hachoir electrique 7	Elec.stick blender+chopper blade set 700	5,20
61671	R61671J	Conectores varilla+cabezal 2 pcs	Connecteurs pour fouet+moteur mixeur 2pc	Stick & motor connection parts 2 pcs	1,75
61672	R61672A	Cuchilla lisa BAMIX	Disque fouet pour BAMIX	Plain/beater blade for BAMIX mixer	9,85
61672	R61672B	Cuchilla pure BAMIX	Disque à purée pour BAMIX	Purée/whisk blade for BAMIX mixer	9,85
61672	R61672C	Cuchilla multiproposito BAMIX	Couteau à emulsion pour BAMIX	Multipurpose/chopping blade for BAMIX	11,50
61672	R61672D	Cuchilla de carne BAMIX	Couteau standard pour BAMIX	Meat blade for BAMIX mixer	14,65
61672	R61672E	Eje de transmision gastro 200	Transmission axe pour gastro 200	Gastro 200 transmission axle	69,00
61672	R61672F	Motor 200w/230, 240 v BAMIX	Moteur 200w 230-240v mixer BAMIX	BAMIX 200 w/230, 240v motor	86,60
61672	R61672G	Escobilla carbono c/muelle BAMIX 200-350	Brosse BAMIX gastro	BAMIX mixer carbon brush w/spring	2,55
61672	R61672H	Cable batidor BAMIX 200w	Câble mixer BAMIX 200w	BAMIX mixer 200w cordset, light grey	39,90
61672	R61672J	Carcasa mango BAMIX 200-350w	Carcasse poignee mixer BAMIX 200-350w	BAMIX mixer handle-d	13,55
61672	R61672K	Tapa mango batidor BAMIX 200-350w	Protecteur poignee BAMIX mixer 200-350w	BAMIX mixer handle cover-d	3,25
61672	R61672I	Acoplamiento+arandela goma batidor BAMIX	Accolement+rondelle mixer BAMIX 200-350	BAMIX mixer rubber coupling+trans.washer	7,20
61672	R61672M	Rodamiento eje transmis.batidor BAMIX	Roulement mixer BAMIX 200-350w	BAMIX mixer bearing for transmision	1,55
61672	R61672N	Set 4 tornillos batidora BAMIX	Ensemble 4 vis mixer BAMIX	BAMIX mixer screws	1,20
61672	R61672P	Interruptor batidor BAMIX 200-350w	Interrupteur pour mixer BAMIX 200-350w	200-350 w BAMIX mixer in/off switch	25,95
61672	R61672Q	Cabezal protector cuchilla BAMIX 200/350	Protecteur du lame BAMIX 200/350w	BAMIX stick blender 200/350w blade guard	13,35
61672	R61672R	Pie batidorpara bamix 61672	Pie pour mixeur electrique 400w	Stainless steel tube for bamix 61672	5,60
61673	R61672A	Cuchilla lisa BAMIX	Disque fouet pour BAMIX	Plain/beater blade for BAMIX mixer	9,85
61673	R61672B	Cuchilla pure BAMIX	Disque à purée pour BAMIX	Purée/whisk blade for BAMIX mixer	9,85
61673	R61672C	Cuchilla multiproposito BAMIX	Couteau à emulsion pour BAMIX	Multipurpose/chopping blade for BAMIX	11,50
61673	R61672D	Cuchilla de carne BAMIX	Couteau standard pour BAMIX	Meat blade for BAMIX mixer	14,65
61673	R61672G	Escobilla carbono c/muelle BAMIX 200-350	Brosse BAMIX gastro	BAMIX mixer carbon brush w/spring	2,55
61673	R61672J	Carcasa mango BAMIX 200-350w	Carcasse poignee mixer BAMIX 200-350w	BAMIX mixer handle-d	13,55
61673	R61672K	Tapa mango batidor BAMIX 200-350w	Protecteur poignee BAMIX mixer 200-350w	BAMIX mixer handle cover-d	3,25
61673	R61672I	Acoplamiento+arandela goma batidor BAMIX	Accolement+rondelle mixer BAMIX 200-350	BAMIX mixer rubber coupling+trans.washer	7,20
61673	R61672M	Rodamiento eje transmis.batidor BAMIX	Roulement mixer BAMIX 200-350w	BAMIX mixer bearing for transmision	1,55
61673	R61672N	Set 4 tornillos batidora BAMIX	Ensemble 4 vis mixer BAMIX	BAMIX mixer screws	1,20
61673	R61672P	Interruptor batidor BAMIX 200-350w	Interrupteur pour mixer BAMIX 200-350w	200-350 w BAMIX mixer in/off switch	25,95
61673	R61672Q	Cabezal protector cuchilla BAMIX 200/350	Protecteur du lame BAMIX 200/350w	BAMIX stick blender 200/350w blade guard	13,35
61673	R61672R	Pie batidorpara bamix 61672	Pie pour mixeur electrique 400w	Stainless steel tube for bamix 61672	5,60
61673	R61673A	Eje transmision gastro 350	Transmission axe pour gastro 350	Gastro 350 transmission axle	153,45
61673	R61673F	Motor 350w/230,240 v BAMIX	Moteur 350w 230-240v mixer BAMIX	BAMIX 350 w/230, 240v motor	96,65
61673	R61673H	Cable batidor BAMIX 350w	Câble mixer BAMIX 350w	BAMIX mixer 350w cordset, light grey	42,10
61676	R61676C	Vaso 500 ml batidor electrico 400 w	Glas pour mixeur electrique 400w	400 w hand mixer beaker	2,35
61676	R61676E	Pie batidor electrico 400 w	Pie pour mixeur electrique 400w	400 w hand mixer stick	8,95
61677	R61677A	Base soporte batidor electrico sin cable	Chargeur pour mixeur sans câble electr.	Stand for batteries operated stick blend	2,05
61677	R61677B	Pie batidor electrico sin cable	Pied pour mixeur electri sans câble	Stick for batteries operated stick blend	10,40
61677	R61677C	Transfor.ac/dc batidor electrico s/cable	Transform.pour mixeur sans câble electr.	Ac/dc transform.batteries operat.stick	20,85
61677	R61677D	Bateria repues.batidor electrico s/cable	Batterie pour mixeur sans câble electr.	Spare battery cordless hand mixer	46,70
61690	R61690A	Contenedor de alimentos 2 l 61690	Recipient pour aliments 2 l 61690	Food container 2 l 61690	7,00



Ref.	Repuesto	Descripción	Description	Description	€
61690	R61690B	Cuchilla naranja rallador para 61690	Orange rape lame pour 61690	Orange grater blade for 61690	6,30
61690	R61690C	Cuchilla verde juliana para 61690	Vert juliennee lame pour 61690	Green julianne blade for 61690	7,55
61690	R61690D	Cuchilla rodajas + chip para 61690	Tranches + chip lame pour 61690	Blade for slices + chips 61690	7,95
61690	R61690F	Tapa principal + empujador para 61690	Presseur + couvercle principa pour 61690	Main lid + presser for 61690	17,80
61690	R61690G	Pies en ventosa para 61690	Pieds en ventouse pour 61690	Sucker feet for 61690	4,25
61690	R61690H	Conjunto motor para 61690	Moteur set pour 61690	Motor set for 61690	100,55
61700	R61700	Repuesto cabezal bascula 150 kgs.	Secours head balance 150 kgs	Head for electronic bench scale 150 kg	324,70
61700	R61700A	Pie goma báscula electrónica 150 kg.	Pied en caoutchouc pour balance 150kg.	Rubber feet for 150 kg. electronic scale	4,50
61700	R61700B	SopORTE cabezalbascula 150 kgs.	Support pour computeur balance 150 kg.	Computer stand for 150 kg. elec. scale	13,35
61700	R61700C	Cable conexion bascula 61716/61700	Câble branchement balance 61716/61700	Power cord for scale 61716/61700	4,40
61700	R61700D	Bateria bascula 61716/61700	Batterie balance 61716/61700	Battery for scale 61716/61700	13,75
61700	R61700E	Fusible bascula 61716/61700	Fusible balance 61716/61700	Fuse for scale 61716/61700	3,45
61700	R61700F	Placa de control báscula elec. 150 kg.	Plaque du control balance elec. 150 kg.	Control card elec. bench 150 kg.	133,40
61700	R61700G	Teclado báscula elec. 150 kg.	Clavier balance elec. 150 kg.	Key board elec. bench 150 kg.	10,30
61700	R61700H	Display báscula elec. 150 kg.	Display balance elec. 150 kg.	Display elec. bench 150 kg.	13,75
61700	R61700J	Célula de carga báscula elec. 150 kg.	Cellule de charge balance elec. 150 kg.	load cell elec. bench 150 kg.	139,40
61700	R61716K	Transformador básculas 61700/61716	Transformateur p/ balance cuisine elec.	Transformer for electronic scale 61700/6	7,20
61716	R61700C	Cable conexion bascula 61716/61700	Câble branchement balance 61716/61700	Power cord for scale 61716/61700	4,40
61716	R61700D	Bateria bascula 61716/61700	Batterie balance 61716/61700	Battery for scale 61716/61700	13,75
61716	R61700E	Fusible bascula 61716/61700	Fusible balance 61716/61700	Fuse for scale 61716/61700	3,45
61716	R61714A	Bol inox repuesto bascula cocina 5 kg 2l	Plateau inox por balance 5 kg	Spare bowl 5 kg mechann.kitchen scale 2l	6,50
61716	R61716A	Pies de goma báscula electrónica 15 kg.	Pied à caoutchouc p/balance elec. 15 kg.	Rubber feet for 15 kg. electronic scale	4,15
61716	R61716B	Interruptor báscula elec. 61700 / 61716	Interrupteur p/balance elec. 61700/61716	In/off switch elec. scale 61700/61716	1,10
61716	R61716F	Placa de control báscula elec. 15 kg	Plaque du control balance elec. 15 kg.	Control card elec. bench 15 kg.	114,90
61716	R61716G	Teclado báscula elec. 15 kg.	Clavier balance elec. 15 kg.	Key board elec. bench 15 kg.	10,30
61716	R61716H	Display báscula elec. 15 kg.	Display balance elec. 15 kg.	Display elec. bench 15 kg.	13,75
61716	R61716J	Célula de carga báscula elec. 15 kg.	Cellule de charge balance elec. 15 kg.	load cell elec. bench 15 kg.	51,40
61716	R61716K	Transformador básculas 61700/61716	Transformateur p/ balance cuisine elec.	Transformer for electronic scale 61700/6	7,20
61716	R61716M	Placa control software 7.0 para 61716	Panneau de commande software 7.0 61716	Mainboard software 7.0 for 61716	123,40
61716	R61716Q	Bandeja de acero inoxidable	Plateau en acier inoxydable	Stainless steel tray	45,40
61716	R61716R	Base de plastico para 61716-30	Plaque plastique pour 61716-30	Plastic plate for 61716-30	16,60
61725	R61725A	Cristal bascula electronica cocina 5 kg.	Verre pour balance électronique cuisine	Glass for 5 kg kitchen electronic scale	5,00
61730	R61700C	Cable conexion bascula 61716/61700	Câble branchement balance 61716/61700	Power cord for scale 61716/61700	4,40
61730	R61700D	Bateria bascula 61716/61700	Batterie balance 61716/61700	Battery for scale 61716/61700	13,75
61730	R61700E	Fusible bascula 61716/61700	Fusible balance 61716/61700	Fuse for scale 61716/61700	3,45
61730	R61716A	Pies de goma báscula electrónica 15 kg.	Pied à caoutchouc p/balance elec. 15 kg.	Rubber feet for 15 kg. electronic scale	4,15
61730	R61716B	Interruptor báscula elec. 61700 / 61716	Interrupteur p/balance elec. 61700/61716	In/off switch elec. scale 61700/61716	1,10
61730	R61716F	Placa de control báscula elec. 15 kg	Plaque du control balance elec. 15 kg.	Control card elec. bench 15 kg.	114,90
61730	R61716H	Display báscula elec. 15 kg.	Display balance elec. 15 kg.	Display elec. bench 15 kg.	13,75
61730	R61716K	Transformador básculas 61700/61716	Transformateur p/ balance cuisine elec.	Transformer for electronic scale 61700/6	7,20
61730	R61730F	Placa de control báscula electron. 30 kg	Plaque du control balance electron.30 kg	Pcb mainboard electronic scale 30 kg.	149,05
61730	R61730G	Teclado báscula electronica 30 kg	Clavier balance électronique 30 kg	Key board electronic square scale 30 kg	24,40
61730	R61716K	Transformador básculas 61700/61716	Transformateur p/ balance cuisine elec.	Transformer for electronic scale 61700/6	7,20
61730	R61716M	Placa control software 7.0 para 61716	Panneau de commande software 7.0 61716	Mainboard software 7.0 for 61716	123,40
61730	R61716Q	Bandeja de acero inoxidable	Plateau en acier inoxydable	Stainless steel tray	45,40
61730	R61716R	Base de plastico para 61716-30	Plaque plastique pour 61716-30	Plastic plate for 61716-30	16,60
61735	R61735A	Cristal d.18 cm para bascula electronica	Verre d.18 cm pour balance élect.cuisine	18 cms glass for elect.kitchen scale	4,25
61903	R61904A	Cuerpo repuesto especiero plastico	Corps rechange pour saupoudreuse plastic	Spare part body for plastic shaker	4,25
61904	R61904A	Cuerpo repuesto especiero plastico	Corps rechange pour saupoudreuse plastic	Spare part body for plastic shaker	4,25
61905	R61904A	Cuerpo repuesto especiero plastico	Corps rechange pour saupoudreuse plastic	Spare part body for plastic shaker	4,25
61906	R61904A	Cuerpo repuesto especiero plastico	Corps rechange pour saupoudreuse plastic	Spare part body for plastic shaker	4,25
61907	R61904A	Cuerpo repuesto especiero plastico	Corps rechange pour saupoudreuse plastic	Spare part body for plastic shaker	4,25
61909	R61904A	Cuerpo repuesto especiero plastico	Corps rechange pour saupoudreuse plastic	Spare part body for plastic shaker	4,25
62051	R62051A	Filtro inf.cafet.express moka 10 tazas	Filtere inf. cafetière express moka 10 t.	Bottom filter for moka exp.coff.10 cups	8,75
62051	R62051B	Junta silic. cafet.express moka 10 tazas	Joint caoutchouc cafetièreexpressmoka10	Rubber join for moka expr.coffe.10 cups	3,45
62051	R62051C	Filtro sup. cafet.express moka 10 tzs.	Filtere supérieur cafetière exp.moka 10 t	Upper filter for moka express coffee 10c	3,15
62054	R62054A	Filtro inf.cafet.express moka 4 tazas	Filtere inf. cafetière express moka 4 t	Bottom filter for moka exp.coff.4 cups	4,50
62054	R62054B	Junta silic. cafet.express moka 4 tazas	Joint caoutchouc cafetière expressmoka4	Rubber join for moka expr.coffee.4 cups	2,35
62054	R62054C	Filtro sup. cafet.express moka 4 tzs.	Filtere supérieur cafetière exp.moka 4 t.	Upper filter for moka express coffe 4 c.	1,95
62056	R62056A	Filtro inf.cafet.express moka 6 tazas	Filtere inf. cafetière express moka 6 t.	Bottom filter for moka exp.coff.6 cups	6,00
62056	R62056B	Junta silic. cafet.express moka 6 tazas	Joint caoutchouc cafetièreexpressmoka 6	Rubber join for moka expr.coffee.6 cups	2,25
62056	R62056C	Filtro sup. cafet.express moka 6 tzs.	Filtere supérieur cafetière exp.moka 6 t.	Upper filter for moka express coffee 6c.	2,05
62101	R62101A	Cristal para cafetera 1.00 lts.	Verre pour cafeterie 1.00 lts.	Glass for coffee pot 1.00 lts.	10,50
62101	R62101C	Conjunto filtro cafetera cristal 1.0 lts	Assem.filtere cafeterie en verre 1.0 lts	Filter set for glass coffee maker 1.0 lt	7,75
62101	R62180B	Micro filtro cafetera cristal 0.8-1.00	Microfiltre pour cafeterie en verre 0.8	0.8-1.0lts. glass coffee pot microfilter	7,75
62102	R62202	Filtro inferior cafet.luxe/hyper 2 tazas	Filtere inférieur cafetière lux/hyp 2 tas	Bottom filter luxe/hyper exp.coffee 2 ca	4,15
62102	R62212	Filtro superior cafetera lux/hyp 2 tz	Filtere supérieur cafetière lux/hyp 2 t	Upper filter lux/hyp exp.coffee 2 ts	1,10
62102	R62222	Pisador cafe cafetera lux/hyp 2 tz	Poussoir cafetière lux/hyp 2 tas	Coffee pusher lux/hyp exp.coffe 2 tz	1,10
62102	R62232	Junta cafetera luxe/hyperluxe 2tz	Joint caoutchouc cafetière lux/hyp 2 t	Rubber join lux/hyp exp.coffee 2 t	1,85
62103	R62103	Asa cafetera 3 t.negra	Anse cafetière 3 t	Handle coffee-pot 3 c	2,05
62103	R62112A	Asa cafetera express conica 4-6-12 tzs	Poignée pour cafetiere express conique	4-6-12 cups express coffee maker handle	1,40
62103	R62160	Filtro inferior cafetera 4 tzs caf.con.	Filtere inférieur cafetière express con.	Bottom filter for conical exp.coff.4 cup	1,10
62103	R62163	Pisador de cafe 4 tzs. caf.express conic	Poussoir cafetière express conique 4 tas	Coffee pusher for conical express 4cups	1,10
62103	R62166	Junta de goma 4 tzs. caf.exp.conica	Joint caoutchouc cafetière express con.4	Rubber join for conical expr.coffe.4 cup	1,10
62103	R62169	Filtro superior 4 tz- caf.exp.conica	Filtere supérieur cafetière exp.con. 4 t	Upper filter for conical exp.coffe 4cup	1,10



Ref.	Repuesto	Descripción	Description	Description	€
62104	R62104	Asa cafetera 6/12 t. negra	Anse cafetiere 6/12 t	Handle coffee-pot 6/12 c	2,75
62104	R62204	Filtro inferior cafetera luxe/hyp. 4 tz	Filtre inférieur cafetière lux/hyp 4 tas	Bottom filter luxe/hyperluxe exp.coffe 4	4,50
62104	R62214	Filtro superior cafetera lux/hyp 4 tz	Filtre supérieur cafetière lux/hyp 4 ts	Upper filter lux/hyp expr.coffee 4 ts	1,40
62104	R62224	Pisador cafe cafetera luxe/hyperluxe 4t	Poussoir cafetière lux/hyp 4 tasses	Coffee pusher lux/hyp exp.coffee 4 ca	1,10
62104	R62234	Junta cafetera lux/hyp 4 tzas	Joint caoutchouc cafetière lux/hyp 4 t	Rubber join lux/hyp exp.coffee 4 t	2,05
62106	R62112A	Asa cafetera express conica 4-6-12 tzs	Poignée pour cafetiere express conique	4-6-12 cups express coffee maker handle	1,40
62106	R62161	Filtro inferior cafetera conica 6 tzas	Filtre inférieur cafetiere exp.coni. 6 t	Bottom filter for conical exp.coff.6 cup	1,40
62106	R62164	Pisador de cafe cafetera conica 6 tzs	Poussoir cafetière exp.coniq.6 tass	Coffee pusher for conical exp.coffee 6c.	1,10
62106	R62170	Filtro superior cafetera conica 6 tz	Filtre inférieur cafetière exp.coniq. 12	Upper filter for conical exp.coffee 6cup	1,10
62107	R62216	Filtro superior cafetera lux/hyp 6 tzs	Filtre supérieur cafeti lux/hyp 6 ts	Upper filter luxe/hyper exp.coffee 6	1,55
62107	R62226	Pisador cafe cafetera lux/hyp 6 tzas	Poussoir cafetière lux/hyp 6 tasse	Coffee pusher lux/hyp exp.coffee 6 caps	1,10
62107	R62236	Junta cafetera lux/hyp 6 tzas	Joint caoutchouc cafetière lux/hyp 6 t	Rubber join lux/hyp exp.coffee 6 t	2,25
62107	R62507	Filtro inferior cafetera expres luxe 6 t	Filtre inférieur cafetière luxe 6 tasse	Bottom filter luxe express coffee m.6 c	4,70
62111	R62111	Embudo cafetera 12 t.	Entonnoir cafetiere 12 t	Funnel coffee-pot 12 c	5,70
62111	R62211	Filtro superior cafet.luxe/hyp 10 tz	Filtre supérieur cafetière lux/hyp 10 ts	Upper filter lux/hyp expr.coffee 10 ts	2,25
62111	R62221	Pisador cafe cafetera lux/hyp 10 tz	Poussoir cafetière lux/hyp 10 tas	Coffee pusher lux/hyp exp.coffee 10 tz	1,55
62111	R62231	Junta cafetera lux/hyp 10 tzas	Joint caoutchouc cafetière lux/hyp 10 t	Rubber join lux/hyp exp.coffee 10 t	3,25
62111	R62501	Filtro inferior cafetera expres luxe 10	Filtre inférieur cafetière luxe 10 t	Bottom filter luxe express coffee m.10 c	7,75
62112	R62112A	Asa cafetera express conica 4-6-12 tzs	Poignée pour cafetiere express conique	4-6-12 cups express coffee maker handle	1,40
62112	R62114	Goma cafetera 12 t.	Caoutchouc cafetiere 12 t	Rubber coffee pot 12 c	1,10
62112	R62162	Filtro inferior 12 tz. caf.exp. conica	Filtre inférieur cafetiere exp.coni.12 t	Bottom filter for conical exp.coff.12cup	1,55
62112	R62165	Pisador de cafe 12 tzs cafetera conica	Poussoir cafetière exp.coniq. 12 t	Coffee pusher for conical exp.coff. 12 c	1,10
62112	R62171	Filtro superior caf.exp.conica 12 t	Filtre supérieur cafet.exp.coniq.12 tas	Upper filter for conical exp.coffe 12cu	1,10
62153	R62153A	Cristal para cafetera 0.35 lts.	Verre pour cafeterie 0.35 lts.	Glass for coffee pot 0.35 lts.	7,85
62153	R62153B	Micro filtro cafetera cristal 0.35 lts.	Microfiltre pour cafeterie en verre 0.35	0.35 lts. glass coffee pot microfilter	6,20
62153	R62153C	Conjunto filtro cafetera cristal 0.35lts	Assem.filtre cafeterie en verre 0.35 lts	Filter set for glass coffee maker 0.35lt	5,00
62180	R62180A	Cristal para cafetera 0.80 lts.	Verre pour cafeterie 0.80 lts.	Glass for coffee pot 0.80 lts.	9,85
62180	R62180B	Micro filtro cafetera cristal 0,8-1.00	Microfiltre pour cafeterie en verre 0.8	0.8-1.0lts. glass coffee pot microfilter	7,75
62180	R62180C	Conjunto filtro cafetera cristal 0.80lts	Assem.filtre cafeterie en verre 0.80 lts	Filter set for glass coffee maker 0.80lt	6,90
62202	R62202	Filtro inferior cafet.luxe/hyper 2 tzas	Filtre inférieur cafetière lux/hyp 2 tas	Bottom filter luxe/hyper exp.coffee 2 ca	4,15
62202	R62212	Filtro superior cafetera lux/hyp 2 tz	Filtre supérieur cafetière lux/hyp 2 ts	Upper filter lux/hyp expr.coffee 2 ts	1,10
62202	R62222	Pisador cafe cafetera lux/hyp 2 tz	Poussoir cafetière lux/hyp 2 tas	Coffee pusher lux/hyp exp.coffee 2 tz	1,10
62202	R62232	Junta cafetera luxe/hyperluxe 2tz	Joint caoutchouc cafetière lux/hyp 2 t	Rubber join lux/hyp exp.coffee 2 t	1,85
62204	R62204	Filtro inferior cafetera luxe/hyp. 4 tz	Filtre inférieur cafetière lux/hyp 4 tas	Bottom filter luxe/hyperluxe exp.coffe 4	4,50
62204	R62214	Filtro superior cafetera lux/hyp 4 tz	Filtre supérieur cafetière lux/hyp 4 ts	Upper filter lux/hyp expr.coffee 4 ts	1,40
62204	R62224	Pisador cafe cafetera luxe/hyperluxe 4t	Poussoir cafetière lux/hyp 4 tasses	Coffee pusher lux/hyp exp.coffee 4 ca	1,10
62204	R62234	Junta cafetera lux/hyp 4 tzas	Joint caoutchouc cafetière lux/hyp 4 t	Rubber join lux/hyp exp.coffee 4 t	2,05
62206	R62206	Filtro inferior cafetera hyp 6 tz	Filtre inférieur cafetière lux/hyp 6 t	Bottom filter luxe/hyperluxe exp.coffe 6	5,20
62206	R62216	Filtro superior cafetera lux/hyp 6 tzs	Filtre supérieur cafeti lux/hyp 6 ts	Upper filter luxe/hyper exp.coffee 6	1,55
62206	R62226	Pisador cafe cafetera lux/hyp 6 tzas	Poussoir cafetière lux/hyp 6 tasse	Coffee pusher lux/hyp exp.coffee 6 caps	1,10
62206	R62236	Junta cafetera lux/hyp 6 tzas	Joint caoutchouc cafetière lux/hyp 6 t	Rubber join lux/hyp exp.coffee 6 t	2,25
62211	R62111	Embudo cafetera 12 t.	Entonnoir cafetiere 12 t	Funnel coffee-pot 12 c	5,70
62211	R62201	Filtro interior cafetera hyperluxe 10 t	Filtre inférieur cafetière hyp.10 tasse	Bottom filter hyperluxe exp.coffe 10 ca	7,75
62211	R62211	Filtro superior cafet.luxe/hyp 10 tz	Filtre supérieur cafetière lux/hyp 10 ts	Upper filter lux/hyp expr.coffee 10 ts	2,25
62211	R62221	Pisador cafe cafetera lux/hyp 10 tz	Poussoir cafetière lux/hyp 10 tas	Coffee pusher lux/hyp exp.coffee 10 tz	1,55
62211	R62231	Junta cafetera lux/hyp 10 tzas	Joint caoutchouc cafetière lux/hyp 10 t	Rubber join lux/hyp exp.coffee 10 t	3,25
62303	R62303	Tapon "oro" para coctelera g.(0,50/0,75)	Bouchon pour shaker 50 + 75 cl	Inox lid for shaker 50 & 75 cl.	7,00
62303I	R62303I	Tapon coctelera inox.med/gde (0.50/0.75)	Bouchon or shaker 0.50/0.75	id for shaker 0.50/0.75	5,40
62304	R62303	Tapon "oro" para coctelera g.(0,50/0,75)	Bouchon pour shaker 50 + 75 cl	Inox lid for shaker 50 & 75 cl.	7,00
62308I	R62308I	Tapon coctelera inox. (0.30)	Bouchon inox shaker 0.30	id for shaker 0.30	4,70
62332	R62332	Tapa cubitera d/pared 1.5lt	Couvercle pour seau à glaçons isoth 1.5	Double wall ice bucket 1.5 lts lid	11,10
62333	R62333	Tapa cubitera d/pared 3 lts	Couvercle pour seau à glaçons isoth 3	Double wall ice bucket 3 lts lid	13,85
62341	R62341	Boquilla repuesto servidor revolver	Doseur standardr 4 cl	Spare optic 4 cl for drink server	20,65
62363	R62363A	Tapa+pinza cubitera d.p. acrilico	Couvercle+pinze seau à glace isotherme	Acrylic d.w. ice bucket spare lid+tong	6,10
62375	R62375A	Cuchara dispensador te 3 cav	Cuillère dispensatrice du te 3 cavité	Tea server box spare spoon	1,10
62377	R62377A	Bol verde para soporte snack 0.3 lts	Bol vert à support snack 0.3 lts	Spare green bowl f/snack tray set 0.3 lt	3,35
62377	R62377B	Bol morado para soporte snack 0.3 lts	Bol violet à support snack 0.3 lts	Spare violet bowl f/snack tray set 0.3	3,35
62377	R62377C	Bol naranja para soporte snack 0.3 lts	Bol orange à support snack 0.3 lts	Spare orange bowl f/snack tray set 0.3	3,35
62378	R62378A	Tenedor+cuchara para ensaladera acrilica	Fourchette+cuillère p/saladier acrylique	Acrylic fork+spoon for salad bowl	4,50
62379	R62379A	Pomo repuesto fuente acrilica oval	Bouton pour plat oval acrylique	Acrylic oval tray spare knob	32,15
62381	R62381B	Base+soporte para 62381	Socle pour 62381	Stand for 62381	8,55
62382	R62284A	Botella grande para 62284/82	Grande bouteille pour 62284/82	Big bottle for 62284/82	3,75
62382	R62284B	Botella pequeña para 62284/82	Petite bouteille pour 62284/82	Small bottle for 62284/82	2,45
62382	R62382A	Tapon aceitera-vinagrera ceramica	Bouchon pour huilier en ceramique	Ceramic cruet set oil-vinegar cup	1,40
62384	R62284A	Botella grande para 62284/82	Grande bouteille pour 62284/82	Big bottle for 62284/82	3,75
62384	R62284B	Botella pequeña para 62284/82	Petite bouteille pour 62284/82	Small bottle for 62284/82	2,45
62384	R62382A	Tapon aceitera-vinagrera ceramica	Bouchon pour huilier en ceramique	Ceramic cruet set oil-vinegar cup	1,40
62384	R62384A	Vinagrera de ceramica para 62384	Vinagrera de céramique pour 62384	Ceramic cruet for 62384	11,80
62384	R62384B	Base+soporte para 62384	Socle pour 62384	Stand for 62384	24,75
62384	R62384C	Salero de ceramica para 62384	Conteneur de sel pour 62384	Container of salt for 62384	5,90
62384	R62384D	Pimentero de ceramica para 62384	Poivre conteneur pour 62384	Pepper container for 62384	5,90
62384	R62384E	Aceitera de ceramica para 62384	Vinagrera de céramique pour 62384	Ceramic cruet for 62384	11,80
62387	R62387A	Bol verde+tapa juego snack bar 3 cav.	Bol vert+couverc.ens.snak bar 3 cav.	Green bol+lid for snack bar set w/met.fr	7,20
62387	R62387B	Bol morado+tapa juego snack bar 3 cav.	Bol violet+couverc.ensemble snak bar	Violet bol+lid for snack bar set	7,20
62387	R62387C	Bol naranja+tapa juego snack bar 3 cav.	Bol orange+couverc.ensemble snak bar	Orange bol+lid for snack bar set	7,20
62391	R62391A	Tapa jarra agua acrilica 2,8 lts	Couvercle pour pot à verser acrylique	Acrylic water pitcher lid	4,50
62412	R62417	Tapa repuesto bote cuadrado 11 cms.	Couvercle boite carre en inox 11 cms	Spare part lid square canister 11 cms	2,25
62412	R62419	Junta repuesto bote cuadrado 11 cm	Joint de silicone pour boite carre 11 cm	Silicone ring for square canister 11 cms	1,10
62417	R62417	Tapa repuesto bote cuadrado 11 cms.	Couvercle boite carre en inox 11 cms	Spare part lid square canister 11 cms	2,25
62417	R62419	Junta repuesto bote cuadrado 11 cm	Joint de silicone pour boite carre 11 cm	Silicone ring for square canister 11 cms	1,10
62418	R62417	Tapa repuesto bote cuadrado 11 cms.	Couvercle boite carre en inox 11 cms	Spare part lid square canister 11 cms	2,25
62418	R62419	Junta repuesto bote cuadrado 11 cm	Joint de silicone pour boite carre 11 cm	Silicone ring for square canister 11 cms	1,10
62419	R62420	Junta repuesto bote cuadrado 14 cms	Joint de silicone pour boite carre 14 cm	Silicone ring for square canister 14 cms	1,95



Ref.	Repuesto	Descripción	Description	Description	€
62426	R62420	Junta repuesto bote cuadrado 14 cms	Joint de silicone pour boite carre 14 cm	Silicone ring for square canister 14 cms	1,95
62427	R62420	Junta repuesto bote cuadrado 14 cms	Joint de silicone pour boite carre 14 cm	Silicone ring for square canister 14 cms	1,95
62440	R62448A	Tapon plastic termo solid 0.75-1.0-1,5 l	Bouchon plastique thermo solides 0.75-1.	0.75-1.00 thermal plastic stopper solids	1,65
62441	R62441A	Tapa inox termo liquido 0.35-0.50	Bouchon inox thermo liquides 0.35-0.5	0.35-0.5 thermal st. steel stopper liquid	0,90
62441	R62441B	Tapon plastic termo liquido 0.35-0.50	Bouchon plastique thermo lig. 0.35-0.50	0.35-0.50 thermal plastic stopper liquid	1,10
62442	R62441A	Tapa inox termo liquido 0.35-0.50	Bouchon inox thermo liquides 0.35-0.5	0.35-0.5 thermal st. steel stopper liquid	0,90
62442	R62441B	Tapon plastic termo liquido 0.35-0.50	Bouchon plastique thermo lig. 0.35-0.50	0.35-0.50 thermal plastic stopper liquid	1,10
62443	R62443A	Tapa inox termo liquido 0.75-1-00 l.	Bouchon inox thermo liquides 0.75-1.00	0.75-1.00 thermal st. steel stopper liqu	1,65
62443	R62443B	Tapon plastic termo liquido 0,75-1,00 l	Bouchon plastique thermo liq. 0,72-1,00	0,75-1l. thermal plastic stopper liquids	1,30
62444	R62443A	Tapa inox termo liquido 0.75-1-00 l.	Bouchon inox thermo liquides 0.75-1.00	0.75-1.00 thermal st. steel stopper liqu	1,65
62444	R62443B	Tapon plastic termo liquido 0,75-1,00 l	Bouchon plastique thermo liq. 0,72-1,00	0,75-1l. thermal plastic stopper liquids	1,30
62447	R62448A	Tapon plastic termo solid 0.75-1.0-1,5 l	Bouchon plastique thermo solides 0.75-1.	0.75-1.00 thermal plastic stopper solids	1,65
62448	R62448A	Tapon plastic termo solid 0.75-1.0-1,5 l	Bouchon plastique thermo solides 0.75-1.	0.75-1.00 thermal plastic stopper solids	1,65
62448	R62448B	Tapa inox termo alimentos 0,7,1,1,5 lt.	Couvercle pour aliments sol.thermo	id for solid food thermo 0,7,1,1,5 lt.	5,10
62533	R62533A	Tapa para termometro azucar	Couvercle pour thermomètre sucre	id for sugar thermometer	2,35
62461	R62469	Botella cuadrada pequeña (sal-pimienta)	Salière-poivrière carrée petit format	Square small bottle (salt-pepper)	1,85
62461	R62470	Tapon aceite-vinagre	Bouchon huilier-vinaigrier	Oil-vinegar adjustable tap	4,80
62461	R62471	Tapon sal-pimienta	Bouchon salière-poivrière	Salt-pepper tap	3,15
62461	R62474	Soporte cuadrado 2 botellas peq.hiperlux	Socle hyperlux 2 pc pour sel et poivre	Hyperlux 2 square spice bottl. stand	12,30
62462	R62466	Botella redonda grande (aceite-vinagre)	Bouteille ronde grand format (huile-vina	Round big bottle (oil-vinegar)	2,55
62462	R62467	Botella redonda pequeña (sal-pimienta)	Salière-poivrière ronde petit format	Round small bottle (salt-pepper)	1,85
62462	R62470	Tapon aceite-vinagre	Bouchon huilier-vinaigrier	Oil-vinegar adjustable tap	4,80
62462	R62471	Tapon sal-pimienta	Bouchon salière-poivrière	Salt-pepper tap	3,15
62462	R62476	Soporte redondo 2 botellas luxe	Socle 2 pièces rond pour huilier-vinaigr	uxe 2 round bottles stand	12,40
62463	R62468	Botella cuadrada grande (aceite-vinagre)	Bouteille carrée grand format (huile-vin	Square big bottle (oil-vinegar)	2,55
62463	R62469	Botella cuadrada pequeña (sal-pimienta)	Salière-poivrière carrée petit format	Square small bottle (salt-pepper)	1,85
62463	R62470	Tapon aceite-vinagre	Bouchon huilier-vinaigrier	Oil-vinegar adjustable tap	4,80
62463	R62471	Tapon sal-pimienta	Bouchon salière-poivrière	Salt-pepper tap	3,15
62463	R62473	Soporte cuad.2 botellas grandes hyperlux	Socle hyperl.2 pièces pour huilier-vinai	Hyperlux 2 square bot. stand	14,25
62464	R62466	Botella redonda grande (aceite-vinagre)	Bouteille ronde grand format (huile-vina	Round big bottle (oil-vinegar)	2,55
62464	R62467	Botella redonda pequeña (sal-pimienta)	Salière-poivrière ronde petit format	Round small bottle (salt-pepper)	1,85
62464	R62470	Tapon aceite-vinagre	Bouchon huilier-vinaigrier	Oil-vinegar adjustable tap	4,80
62464	R62471	Tapon sal-pimienta	Bouchon salière-poivrière	Salt-pepper tap	3,15
62464	R62475	Soporte redondo 4 botellas luxe	Socle luxe 4 pièces rond nu	uxe 4 round bottles stand	17,50
62465	R62468	Botella cuadrada grande (aceite-vinagre)	Bouteille carrée grand format (huile-vin	Square big bottle (oil-vinegar)	2,55
62465	R62469	Botella cuadrada pequeña (sal-pimienta)	Salière-poivrière carrée petit format	Square small bottle (salt-pepper)	1,85
62465	R62470	Tapon aceite-vinagre	Bouchon huilier-vinaigrier	Oil-vinegar adjustable tap	4,80
62465	R62471	Tapon sal-pimienta	Bouchon salière-poivrière	Salt-pepper tap	3,15
62465	R62472	Soporte cuadrado 4 botellas hyperlux	Socle hyperlux 4 pièces carré un	Hyperlux 4 square bottl. stand	20,15
62466	R62467	Botella redonda pequeña (sal-pimienta)	Salière-poivrière ronde petit format	Round small bottle (salt-pepper)	1,85
62466	R62470	Tapon aceite-vinagre	Bouchon huilier-vinaigrier	Oil-vinegar adjustable tap	4,80
62466	R62471	Tapon sal-pimienta	Bouchon salière-poivrière	Salt-pepper tap	3,15
62467	R62467A	Pulverizador de 62467	Pulvérisation 62467	Spray 62467	11,80
62467	R62467C	Salero para 62467	Sel shaker	Salt shaker	3,85
62467	R62467D	Pimentero para 62467	Poivre shaker	Pepper shaker	3,85
62467	R62467E	Soporte con asa inox. para 62467	Soutien en acier inoxydable pour 62467	Stainless support for 62467	15,75
62472	R62472A	Cabezal air pot 2.5-3.0-3.5 lts.	Bouchon pour air pot 2.5-3.0-3.5 lts	2.5-3.0-3.5 lts. air pot head cover	10,80
62472	R62472B	Tube air pot 2.5 lts.	Tube pour airtop 2.5 lts.	Spout (tube) for airtop 2.5 lts.	3,35
62472	R62472C	2 pcs juntas silicona airtop	Joint in silicone pour airtop 2 pcs	Airtop silicone gaskets 2 pcs	1,75
62472	R62480	Tapa air pot	Couvercle pour airpot	id for airpot	17,10
62473	R62472A	Cabezal air pot 2.5-3.0-3.5 lts.	Bouchon pour air pot 2.5-3.0-3.5 lts	2.5-3.0-3.5 lts. air pot head cover	10,80
62473	R62480	Tapa air pot	Couvercle pour airpo	id for airpot	17,10
62473	R62480	Tapa air pot	Couvercle pour airpo	id for airpot	17,10
62473	R62483	Tube airtop 3.0 lts.	Tube pour airtop 3 lts	Spout (tube) for airtop 3 lts	8,75
62475	R62472A	Cabezal air pot 2.5-3.0-3.5 lts.	Bouchon pour air pot 2.5-3.0-3.5 lts	2.5-3.0-3.5 lts. air pot head cover	10,80
62475	R62472C	2 pcs juntas silicona airtop	Joint in silicone pour airtop 2 pcs	Airtop silicone gaskets 2 pcs	1,75
62475	R62482	Tube airtop 3.5 lts.	Tube pour airtop 3.5 lts	Spout (tube) for airtop 3.5	8,75
62480	R62480	Tapa air pot (mod. Antiguo "a")	Couvercle pour airpo	id for airpot	17,10
62481	R62481	Tapa de servidor termo 1 lt.	Couvercle pour verseuse termo 1,0 lt.	Lid for vacuum flas 1,0 lt.	4,60
62481	R62481A	Junta silicona tapa servidor termo 1.0lt	Joint en silicone pour verseuse termo 1l	Silicone ring for 1.0lt. thermo server	0,70
62482	R62485	Tapa de servidor termo 1,2-1,5-2,0 lts.	Couvercle pour verseuse termo 1,2-1,5-2	Lid for vacuum flask 1.2-1.5-2.0 lt.	6,00
62485	R62485	Tapa de servidor termo 1,2-1,5-2,0 lts.	Couvercle pour verseuse termo 1,2-1,5-2	Lid for vacuum flask 1.2-1.5-2.0 lt.	6,00
62486	R62485	Tapa de servidor termo 1,2-1,5-2,0 lts.	Couvercle pour verseuse termo 1,2-1,5-2	Lid for vacuum flask 1.2-1.5-2.0 lt.	6,00
62491	R62491	Tapon jarra termo policarbonato 1.2 l.	Couvercle pour pichet plicarbonate 1.2l	1.2 l. polycarbonate thermo jug lid+tags	5,10
62492	R62492	Tapon jarra termo policarbonato 2.0 l.	Couvercle pour pichet polycarbonate 2 l.	2.0 l. polycarbonate thermo jug lid+tags	7,85
62496	R62496	Tapon jarra termo policarbonato 0.6 l.	Couvercle pour pichet plicarbonate 0.6l	0.6 l. polycarbonate thermo jug lid+tags	6,40
62497	R62497	Tube inox jarra refrigerad. 2 l	Tube inox réfrigérateur pitcher 2l.	St. steel tube for 2 l. cooler pitcher	20,05
62498	R62498A	Sonda para termometro digital 62498	Captur thermomètre numérique pour 62498	Sensor for digital thermometer 62498	7,75
62499	R62499	Tube inox jarra refrigerad. 3 l	Tube inox réfrigérateur 3l. pitcher	St. steel tube for 3 l. cooler pitcher	21,45
62553	R62553A	Tapa bote termo inox negro	Couvercle p/bote thermos inox noir	St steel thermo baby bottle black lid	1,85
62554	R62554A	Tapa bote termo inox marron	Couvercle p/bote thermos inox marron	St steel thermo baby bottle brown lid	1,85
62557	R62553A	Tapa bote termo inox negro	Couvercle p/bote thermos inox noir	St steel thermo baby bottle black lid	1,85
62558	R62554A	Tapa bote termo inox marron	Couvercle p/bote thermos inox. marron	St steel thermo baby bottle brown lid	1,85
62560	R62560A	Tapa portacomidas silicona 1.0 lt+vaso	Couvercle support silicone aliment.1.0lt	Silicone lunch box 1.0 lts spare lid	3,85
62560	R62560B	Vaso portacomidas silicona 1.0 lt+vaso	Verre support silicone aliment.1.0lt	Silicone lunch box 1.0 lts spare cup	2,25
62561	R62561A	Tapa portacomida silicona 1.0 lts	Couvercle pour support alimentaire 1.0 l	Silicone lunch box lid 1.0 lts	3,35
62561	R62561B	Cubierto portacomida silicona 1.0-1.5 lt	Couvert p/support alimentaire silicone	Silicone lunch box cuttlery 1.0-1.5 lts	2,25
62562	R62562A	Tapa portacomida silicona 0,60 lts	Couv.support silicone aliment.0.60 lts.	Spare lid silicone lunch box 0.60 lts	1,75
62565	R62565A	Tapa portacomida silicona 2 cavid 1.5 lt	Couvercle support aliment.silicone 2 cav	Silicone lunch box 2 cavities lid 1.5 lt	3,35
62576	R62576A	Tapa recipiente termo white 0,35-0,5 l	Couvercle cilindriq. white 0,35-0,5 l	Lid for white vaccum flask 0.35-0,5 l	5,20
62576	R62576B	Tapon recipiente termo white 0,35-0,5 l	Bouchon cilindriq. white 0,35-0,5 l	Liquid stopper vaccum flask 0,35-0,5 l	6,20
62578	R62578A	Tapa recipiente termo white 0,75 l	Couvercle thermo cilindriq. white 0,75 l	Lid for white vaccum flask 0.75 l	5,20
62578	R62578B	Tapon para recipiente termo white 0,75 l	Bouchon thermo cilindriq. white 0,75 l	Liquid stopper white vaccum flask 0.75 l	6,20



Ref.	Repuesto	Descripción	Description	Description	€
62814	R62814A	Muela ceramica molinillo acrilico	Meule céramique moulin en acrylique	Acrylic grinder ceramic whetstone	3,25
62814	R62814B	Tuerca tapa molinillo acrilico	Vis couvercle moulin en acrylique	Acrylic grinder lid nut	0,80
62814	R62814C	Tapa inox molinillo acrilico	Couvercle inox moulin en acrylique	Acrylic grinder stainless steel lid	5,20
62818	R62814A	Muela ceramica molinillo acrilico	Meule céramique moulin en acrylique	Acrylic grinder ceramic whetstone	3,25
62818	R62814B	Tuerca tapa molinillo acrilico	Vis couvercle moulin en acrylique	Acrylic grinder lid nut	0,80
62818	R62814C	Tapa inox molinillo acrilico	Couvercle inox moulin en acrylique	Acrylic grinder stainless steel lid	5,20
62823	R62814A	Muela ceramica molinillo acrilico	Meule céramique moulin en acrylique	Acrylic grinder ceramic whetstone	3,25
62823	R62814B	Tuerca tapa molinillo acrilico	Vis couvercle moulin en acrylique	Acrylic grinder lid nut	0,80
62823	R62814C	Tapa inox molinillo acrilico	Couvercle inox moulin en acrylique	Acrylic grinder stainless steel lid	5,20
62862	R62864A	Tapon aceite-vinagre basic	Bouchon huilier ménagère de table basic	Basic cruet set oil-vinegar cap	1,85
62864	R62864A	Tapon aceite-vinagre basic	Bouchon huilier ménagère de table basic	Basic cruet set oil-vinegar cap	1,85
62864	R62864B	Tapon sal-pimienta basic	Bouchon salière ménagère de table basic	Basic cruet set salt-pepper cap	0,80
62864	R62864C	Soporte vinagrera basic 4 pcs	Socle ménagère de table basic 4 pcs	Basic cruet stand 4 pcs	5,40
62864	R62864D	Botella cristal grande vinagrera basic	Ménagère de table basic	Basic cruet large glass bottle	0,70
62864	R62864E	Botella cristal pequeña vinagrera basic	Ménagère de table basic	Basic cruet small glass bottle	0,50
62866	R62866A	Soporte salero-pimentero basic 2 pcs	Socle basic 2 pcs pour sel et poivre	Basic salt-pepper stand 2 pcs	3,45
62903	R62904	Tapa plastico especiero	Couvercle plastique epices	Plastic spice box lid	1,00
62904	R62904	Tapa plastico especiero	Couvercle plastique epices	Plastic spice box lid	1,00
62905	R62904	Tapa plastico especiero	Couvercle plastique epices	Plastic spice box lid	1,00
62906	R62904	Tapa plastico especiero	Couvercle plastique epices	Plastic spice box lid	1,00
62907	R62904	Tapa plastico especiero	Couvercle plastique epices	Plastic spice box lid	1,00
62980	R62980	Repuesto base picador cebolla ant.	Rechange base hachoir oignons ancien	Antiguo onion cutter replacement base	9,75
62980	R62982	Repuesto vaso trans. pic. cebolla ant.	Rechange bol transparent hachoir oignons	Antiguo onion cutter clear repl. contain	1,40
63004	R63010	Espiga sacacorchos automatico (hembra)	Meche tire-bouchon automatique	Screw for automatic corkscrew	39,80
63004	R63011	Palanca horquilla negra	Fourche noir	ever fork black	72,95
63005	R63005	Cuchilla abrelatas	ame ouvre-boite	Cutting tool for tin opener	8,65
63005	R63006	Rueda abrelatas	Molette ouvre-boite	Wheel for tin opener	13,75
63005	R63005A	Muelle para abrelatas 63005	Resorts pour 63005	Spring for 63005	11,30
63005	R63005B	Tornillo sujeción para abrelatas 63005	Sujetion boulon pour 63005	Subjection bolt for 63005	27,75
63010	R63000	Espiga sacacorchos normal (macho)	Meche tire-bouchon n.	screw for n. corkscrew	31,45
63010	R63011	Palanca horquilla negra	Fourche noir	ever fork black	72,95
63014	R63010	Espiga sacacorchos automatico (hembra)	Meche tire-bouchon automatique	Screw for automatic corkscrew	39,80
63015	R63005	Cuchilla abrelatas	ame ouvre-boite	Cutting tool for tin opener	8,65
63015	R63006	Rueda abrelatas	Molette ouvre-boite	Wheel for tin opener	13,75
63026	R63026	Espiga sacacorchos. luxe "s" 63026	Meche tire-bouchon pour tire bouchonluxe	Screw for 63026-luxe corkscrew	2,45
63027	R63027	Espiga sacacorchos ref 63027	Meche tire bouchon pour 63027	Screw for corkscrew 63027	3,05
63028	R63028A	Espiga sacacorchos zamak negro	Pic pièces pour tire-bouchon cinc	Zinc alloy corkscrew spare spike	5,00
63028	R63028B	Descapsulador sacacorch.zamak negro	Coupe capsule pour tire-bouchon cinc	Zinc alloy corkscrew foil cutter	5,60
63031	R63031A	Transformador sacacorchos electrico	Transformat.pour tire bouchon electricque	Electric corkscrew ac/dc transformer	7,75
63031	R63031B	Base cargador sacacorchos electrico	Support chargeur p/tire-bouchon electr.	Electric corkscrew charger base	6,10
63031	R63031C	Descapsul.+espiga sacacorchos electrico	Coupe capsul+meche tire-bouchon elec.	Electric corkscrew foil cutter+spike	1,75
63033	R63033	Set tapon repust.bomba vacio (2 unid)	Bouchon pour pompe à vide	Wine vaccum sealer cap	2,45
63308	R63308A	Tapon jarra termo esferica 0.80-1.25 lt	Bouchon pichet thermo sphériq. 0.80-1.25	0.80-1.25l. spherical cacuum jug lid	9,95
63053	R63053A	2 taponess repust.bomba vacio	Bouchon pour pompe à vide (2 pcs)	Wine vaccum sealer cap (2 pcs)	5,10
63054	R63054A	Transformador sacacorchos electrico	Transformat.pour tire bouchon electricque	Electric corkscrew ac/dc transformer	8,95
63054	R63054B	Base cargador sacacorchos electrico	Support chargeur p/tire-bouchon electr.	Electric corkscrew charger base	8,95
63054	R63054C	Descapsul.+espiga sacacorchos electrico	Coupe capsul+meche tire-bouchon elec.	Electric corkscrew foil cutter+spike	4,70
63054	R63054D	Bateria para sacacorchos 63054	Batterie bouchon electricque	Electric corkscrew battery	8,95
63310	R63360A	Tapon plastico termo 0,6 l/1 l/1,5 l/2 l	Bouchon plastique thermo 0,6l/1l/1,5l/2l	Thermal plastic stopper 0,6l/ 1l/1,5l/2l	1,00
63315	R63360A	Tapon plastico termo 0,6 l/1 l/1,5 l/2 l	Bouchon plastique thermo 0,6l/1l/1,5l/2l	Thermal plastic stopper 0,6l/ 1l/1,5l/2l	1,00
63316	R63308A	Tapon jarra termo esferica 0.80-1.25 lt	Bouchon pichet thermo sphériq. 0.80-1.25	0.80-1.25l. spherical cacuum jug lid	9,95
63320	R63360A	Tapon plastico termo 0,6 l/1 l/1,5 l/2 l	Bouchon plastique thermo 0,6l/1l/1,5l/2l	Thermal plastic stopper 0,6l/ 1l/1,5l/2l	1,00
63331	R63331A	Accesorios montaje + llave para 63331	Accessoires d installation + clé 63331	Assembly accesories + key for 63331	3,35
63332	R63332A	Accesorios montaje + llave para 63332	Accessoires d installation + clé 63332	Assembly accesories + key for 63332	3,35
63360	R63360A	Tapon plastico termo 0,6 l/1 l/1,5 l/2 l	Bouchon plastique thermo 0,6l/1l/1,5l/2l	Thermal plastic stopper 0,6l/ 1l/1,5l/2l	1,00
63700	R63700A	Tornillo soporte paellera	Vis a crochet paella pan	Screw bracket paella dish	1,10
63700	R63700B	Cazoleta apoyo soporte paellera	Pied pour rechaud plat a paella	Base helper for round dish burner	2,65
63700	R63700G	Grifo quemador 3 salidas para 63700	Robinet pour rechaud do 3 pour 63700	3 output burner valve for 63700	25,25
63700	R63700H	Grifo quemador 1 salida para 63700	Robinet pour rechaud do 1 pour 63700	1 output burner valve for 63700	10,70
63700	R63700J	Grifo quemador 2 salidas pael. 500	Robinet pour rechaud do 2 pael. 500	2 output burner valve pael. 500	16,40
63731	R63700F	Grifo quemador	Robinet pour rechaud	Griffin burner	16,40
63731	R63721A	Pomo accionamiento paellero	Bouton mise en marche appareil à paella	Paella pan regulator knob	1,75
63741	R63700F	Grifo quemador	Robinet pour rechaud	Griffin burner	16,40
63741	R63721A	Pomo accionamiento paellero	Bouton mise en marche appareil à paella	Paella pan regulator knob	1,75
63751	R63700F	Grifo quemador	Robinet pour rechaud	Griffin burner	16,40
63751	R63721A	Pomo accionamiento paellero	Bouton mise en marche appareil à paella	Paella pan regulator knob	1,75
63761	R63700F	Grifo quemador	Robinet pour rechaud	Griffin burner	16,40
63761	R63721A	Pomo accionamiento paellero	Bouton mise en marche appareil à paella	Paella pan regulator knob	1,75
63761	R63761F	R63761F	Grifo quemador 3 salidas para 63761f	Robinet pour rechaud do 3 pour 63761f	20,05
63771	R63700F	Grifo quemador	Robinet pour rechaud	Griffin burner	16,40
63771	R63721A	Pomo accionamiento paellero	Bouton mise en marche appareil à paella	Paella pan regulator knob	1,75
64457	R64457A	Set 6 boquillas de decoración para 64457	6 decorer buses set pour 64457	6 decorating nozzles set for 64457	1,85
64502	R64502A	Set de montaje para 64502	Kit de montage pour 64502	Assembly set for 64502	5,80
66116	R66116A	Rueda sin freno carros gn 1/1-2/1-60x40	Roulette s/frein chariot gn1/1-2/1-60x40	Wheel w/o break trolley gn 1/1-2/1-60x40	10,05
66116	R66116B	Rueda con freno carros gn 1/1-2/1-60x40	Roulette a/frein chariot gn1/1-2/1-60x40	Wheel w/break trolley gn 1/1-2/1-60x40	12,60
66116	R66116C	Juego tornillos carros gn 1/1-2/1-60x40	Ensemble vis chariot gn1/1-2/1-60x40	Bolts set for trolley gn 1/1-2/1-60x40	10,50
66116	R66116D	Barra separador carro gn 1/1	Barre de fixation chariot gn 1/1	Connection bar for gn 1/1	4,70
66118	R66116A	Rueda sin freno carros gn 1/1-2/1-60x40	Roulette s/frein chariot gn1/1-2/1-60x40	Wheel w/o break trolley gn 1/1-2/1-60x40	10,05
66118	R66116B	Rueda con freno carros gn 1/1-2/1-60x40	Roulette a/frein chariot gn1/1-2/1-60x40	Wheel w/break trolley gn 1/1-2/1-60x40	12,60
66118	R66116C	Juego tornillos carros gn 1/1-2/1-60x40	Ensemble vis chariot gn1/1-2/1-60x40	Bolts set for trolley gn 1/1-2/1-60x40	10,50
66118	R66118D	Barra separador carro gn 2/1	Barre de fixation chariot gn 2/1	Connection bar for gn 2/1	7,20





Ref.	Repuesto	Descripción	Description	Description	€
66249	R66349A	Bandeja carro servicio desmontable	Plateaux p/chariot service amovible 80x5	Dismantled service trolley shelf 80x55 c	39,40
66249	R66349B	Pasamanos carro servicio desmontable	Poignée p/chariot de service amovible 80	Dismantled service trolley 80x55 cm hand	16,20
66249	R66349C	Rueda s/freno carro servicio desmontable	Roulette sans frein chariot de service a	Dismantled service trolley wheel w/o bre	3,55
66249	R66349D	Rueda c/freno carro servicio desmontable	Roulette avec frein chariot de service a	Dismantled service trolley wheel w/break	3,85
66349	R66349E	Jgo tornillos carro desmontable 2-3 ban.	Jeu a vis de tension chariot de service	Dismantled service trolley assembly set	4,70
66349	R66349A	Bandeja carro servicio desmontable	Plateaux p/chariot service amovible 80x5	Dismantled service trolley shelf 80x55 c	39,40
66349	R66349B	Pasamanos carro servicio desmontable	Poignée p/chariot de service amovible 80	Dismantled service trolley 80x55 cm hand	16,20
66349	R66349C	Rueda s/freno carro servicio desmontable	Roulette sans frein chariot de service a	Dismantled service trolley wheel w/o bre	3,55
66349	R66349D	Rueda c/freno carro servicio desmontable	Roulette avec frein chariot de service a	Dismantled service trolley wheel w/break	3,85
66349	R66349E	Jgo tornillos carro desmontable 2-3 ban.	Jeu a vis de tension chariot de service	Dismantled service trolley assembly set	4,70
66349	R66349F	Rueda s/freno carro servicio desm. Nueva	Nouveau roul.sans frein chariot service	New dismantled ser. Trolley. Wheel w/o break	7,55
66349	R66349G	Rueda c/freno carro servicio desmo nuevo	Nouveau roulette avec frein char. Serv.	New service trolley wheel w/break	8,05
66353	R66351	Barra sujecion carro plástico	Poignée pour chariot polyéthylène	Plastic trolley handlebar	3,05
66353	R66352	Rueda c/freno carro plastico	Roulette avec frein chariot polyéthylène	Plastic trolley wheel w/brake	9,05
66353	R66353	Rueda s/freno carro plastico	Roulette sans frein chariot polyéthylène	Plastic trolley wheel w/o brake	8,15
66353	R66353A	Pasamanos carro servicio 66353	Balustrades p/chariot service amovible	Dismantled service trolley hand rail	8,55
66353	R66353B	Rueda con freno para 66353	Roue de secours avec frein pour 66353	Spare wheel with brake for 66353	29,45
66353	R66354	Soporte aluminio carro plastico	Souport en aluminio pour chariot polyeth	Plastic trolley aluminium support	3,05
66353	R66353C	Bandeja inferior carro servicio 66353	Plateaux p/chariot service amovible 6633	Dismantled serv.trolley bott.shelf 66353	65,10
66353	R66353D	Bandeja intermedia carro servicio 66353	Plateaux milieu service amovible 66353	Dismantled trolley middle shelf 66353	62,90
66353	R66353F	Bandeja superior carro servicio 66353	Plateaux superieur service amovible66353	Dismantled trolley upper shelf 66353	62,90
66353	R66353G	Barra carro servicio 66353	Barre service amovible66353	Dismantled trolley rod 66353	12,20
66548	R66548A	Rueda c/freno carro portaplatos	Roue avec frein chariot de service à ass	Dish trolley caster with brake	36,55
66548	R66548B	Rueda s/freno carro portaplatos	Roue s/frein chariot de service à assiet	Dish trolley caster w/o brake	29,90
66548	R66548C	Barra sujecion plato negra	Barre de fixation assiette noire	Black dish holding bar	6,30
66548	R66548D	Barra sujecion plato roja	Barre de fixation assiette rouge	Red dish holding bar	6,70
66548	R66548F	Centradores poste carro portaplatos	Centreurs poteau chariot de service à as	Dish trolley post centring devices	13,25
66548	R66548G	Jgo. 4 tornillos tensadores car. portapl.	Jeu 4 vis de tension chariot à assiettes	Set 4 tension adjuns. screws dish trolle	14,65
66548	R66548H	Jgo. 2 protectores carro portaplatos	Jeu de 2 protections chariot à assiettes	Set of 2 dish trolley shields	3,65
66550	R66550A	Rueda con freno para 66550	Roue de secours avec frein pour 66550	Spare wheel with brake for 66550	109,90
66550	R66550B	Rueda sin freno para 66550	Roue de secours sans frein pour 66550	Spare wheel without brake for 66550	87,70
66555	R66555A	Rueda pq. c/freno carro portaplatos	Petite roue a/frein chariot porte-platea	Small wheel w/brake dish cart	25,85
66555	R66555B	Soporte separador+pomo+arandela	Support séparateur + bouton + rondelle	Separator support + knob + washer	59,50
66555	R66555C	Rueda gr. c/freno carro portaplatos	Grande roue chariot porte-plateau	Large wheel dish cart	41,20
66642	R66116A	Rueda sin freno carros gn 1/1-2/1-60x40	Roulette s/frein chariot gn1/1-2/1-60x40	Wheel w/o break trolley gn 1/1-2/1-60x40	10,05
66642	R66116B	Rueda con freno carros gn 1/1-2/1-60x40	Roulette a/frein chariot gn1/1-2/1-60x40	Wheel w/break trolley gn 1/1-2/1-60x40	12,60
66642	R66116C	Juego tornillos carros gn 1/1-2/1-60x40	Ensemble vis chariot gn1/1-2/1-60x40	Bolts set for trolley gn 1/1-2/1-60x40	10,50
66642	R66642D	Barra separador carro 60x40 cm	Barre de fixation chariot 60x40 cm	Connection bar for 60x40 cm	6,40
66775	R66775A	Cierre negro moldes desmontable	Blocage noir pour moule démontable silic	Black locking for dismantable sili.mould	1,65
66776	R66775A	Cierre negro moldes desmontable	Blocage noir pour moule démontable silic	Black locking for dismantable sili.mould	1,65
66777	R66775A	Cierre negro moldes desmontable	Blocage noir pour moule démontable silic	Black locking for dismantable sili.mould	1,65
66980	R66980A	Tapa bote hermetico 5"	Couvercle boite hermétique 5"	Acrylic hermetic lid 5"	6,70
66981	R66980A	Tapa bote hermetico 5"	Couvercle boite hermétique 5"	Acrylic hermetic lid 5"	6,70
66982	R66980A	Tapa bote hermetico 5"	Couvercle boite hermétique 5"	Acrylic hermetic lid 5"	6,70
66983	R66980A	Tapa bote hermetico 5"	Couvercle boite hermétique 5"	Acrylic hermetic lid 5"	6,70
67000	R67000	Rep. conj.cono c/salida y tuerca dos.	Rechange ensemble cone avec sortie	Cone w/opening & dispenser nut repl.kit	32,55
67000	R67001	Repuesto soporte dosificador con mango	Rechange support de dosage avec manche	Handled dispenser repl. support part	29,30
67000	R67002	Base negra dosificador	Doseur base noire	Portionner black base	11,50
67000	R67003	Valvula dosificador reposteria	Valve pour l'entonnoir a decor	Portionner valve	1,30
67000	R67004	Boquilla 4 mm dosificador	Bec 4 mm. de dosage	4 mm. dispenser nozzle	1,55
67000	R67005	Boquilla 6 mm dosificador	Bec 6 mm. de dosage	6 mm. dispenser nozzle	1,55
67000	R67006	Boquilla 8 mm dosificador	Bec 8 mm. de dosage	8 mm. dispenser nozzle	1,55
67142	R67142A	Anillas para rodillo amasar madera 34cm	Anneaux pour rouleau hetre 34 cm	34 cm wooden rolling pin spare rings	4,40
67505	R67505A	Cable conexion cazos electricos	Câble branchement pour casserole elec.	Conection power cord for elec.saucepan	94,55
68090	R68090A	Pvc estecas decoracion fondant 12 pcs	Pvc outils modelisation fondant 12 pcs	Pvc for fondant modeling tools 12 pcs	3,95
68205	R68205	Tapa cafetera pava inox 5 lts.	Couvercle pour cafetiere pava 5 lts	lid for coffee pot 5 lts	4,15
68205	R68205A	Asa repuesto cafetera pava 5.0 lts	Poignée cafetière pava sandwich 5.0 lts	5.0 lts coffee pot spare handle	3,25
68205	R68225A	Asa repuesto caf.pava 2.5-3.5-5 lts	Poignée cafet.pava sandwich 2.5-3.5-5.0l	2.5-3.5-5.0 lts coffee pot spare handle	2,75
68215	R68215	Tapa cafetera pava inox 1,5 lts.	Couvercle pour cafetiere pava 1,5 lts	lid for coffee pot 1,5 lts	2,75
68215	R68215A	Asa repuesto cafetera pava 1.5 lts	Poignée cafetière pava sandwich 1.5 lts	1.5 lts coffee pot spare handle	1,85
68228	R68225	Tapa cafetera pava inox 2,5 lts	Couvercle pour cafetiere pava 2,5 lts	lid for coffee pot 2,5 lts	3,00
68225	R68225A	Asa repuesto caf.pava 2.5-3.5-5 lts	Poignée cafet.pava sandwich 2.5-3.5-5.0l	2.5-3.5-5.0 lts coffee pot spare handle	2,75
68235	R68235	Tapa cafetera pava inox 3,5 lts	Couvercle pour cafetiere pava 3,5 lts	lid for coffee pot 3,5 lts	3,35
68235	R68225A	Asa repuesto caf.pava 2.5-3.5-5 lts	Poignée cafet.pava sandwich 2.5-3.5-5.0l	2.5-3.5-5.0 lts coffee pot spare handle	2,75
68235	R68235A	Asa repuesto cafetera pava 3.5 lts	Poignée cafetière pava sandwich 3.5 lts	3.5 lts coffee pot spare handle	3,15
68400	R68400A	Deposito botella gas sifón	Porte cartouche pour siphom à chantilly	Gas bottle container for cream whipper	12,50
68400	R68400B	Tapón protección rosca sifón	Bouchon protecteur à vis pour siphon	Screw protector cap for cream whipper	2,15
68400	R68400C	Boquilla decoración sifón	Douille forme cannelée pour siphon	Decorating pastry tube for cream whipper	8,95
68400	R68400D	Tuerca roscada sifón	Suppor de douille à vis pour siphon	Screw part for cream whipper	3,55
68400	R68400F	Junta silicona sifón	Joint silicone pour siphon à chantilly	Silicone joint for cream whipper	3,55
68400	R68400G	Válvula inoxidable sifón	Soupape inox pour siphon à chantilly	St. steel valve for cream whipper	14,35
68400	R68400H	Escobilla limpieza sifón	Goupillon pour siphon à chantilly	Cleaning brush for cream whipper	4,70
68400	R68500B	Jgo 6 pcs boquillas sifón crema	ff	6 pcs cream whipper spare set	2,75
68401	R68400A	Deposito botella gas sifón	Porte cartouche pour siphom à chantilly	Gas bottle container for cream whipper	12,50
68401	R68400B	Tapón protección rosca sifón	Bouchon protecteur à vis pour siphon	Screw protector cap for cream whipper	2,15
68401	R68400C	Boquilla decoración sifón	Douille forme cannelée pour siphon	Decorating pastry tube for cream whipper	8,95
68401	R68400D	Tuerca roscada sifón	Suppor de douille à vis pour siphon	Screw part for cream whipper	3,55
68401	R68400F	Junta silicona sifón	Joint silicone pour siphon à chantilly	Silicone joint for cream whipper	3,55
68401	R68400G	Válvula inoxidable sifón	Soupape inox pour siphon à chantilly	St. steel valve for cream whipper	14,35
68401	R68400H	Escobilla limpieza sifón	Goupillon pour siphon à chantilly	Cleaning brush for cream whipper	4,70
68401	R68500B	Jgo 6 pcs boquillas sifón crema	ff	6 pcs cream whipper spare set	2,75
68404	R68400A	Deposito botella gas sifón	Porte cartouche pour siphom à chantilly	Gas bottle container for cream whipper	12,50
68404	R68400B	Tapón protección rosca sifón	Bouchon protecteur à vis pour siphon	Screw protector cap for cream whipper	2,15





Ref.	Repuesto	Descripción	Description	Description	€
68404	R68400C	Boquilla decoración sifón	Douille forme cannelée pour siphon	Decorating pastry tube for cream whipper	8,95
68404	R68400D	Tuerca roscada sifón	Support de douille à vis pour siphon	Screw part for cream whipper	3,55
68404	R68400F	Junta silicona sifón	Joint silicone pour siphon à chantilly	Silicone joint for cream whipper	3,55
68404	R68400G	Válvula inoxidable sifón	Soupape inox pour siphon à chantilly	St. steel valve for cream whipper	14,35
68404	R68400H	Escobilla limpieza sifón	Goupillon pour siphon à chantilly	Cleaning brush for cream whipper	4,70
68404	R68404A	Cabezal aluminio sifón	Tête complète en aluminium pour siphon	Aluminium head for cream whipper	63,80
68404	R68404D	Set boquillas+escobilla+porta cap.sifón	Ensemble pour siphon aluminium	Spare nozzles+brush+cap.holder alu cream	4,05
68404	R68500B	Jgo 6 pcs boquillas sifón crema	Set 6 joint en silicone	6 pcs cream whipper spare set	2,75
68404	R68404C	Set 3 juntas de silicona	Set 3 joint en silicone	3 piece ilicon joint set	6,10
68405	R68400A	Deposito botella gas sifón	Porte cartouche pour siphon à chantilly	Gas bottle container for cream whipper	12,50
68405	R68400B	Tapón protección rosca sifón	Bouchon protecteur à vis pour siphon	Screw protector cap for cream whipper	2,15
68405	R68400C	Boquilla decoración sifón	Douille forme cannelée pour siphon	Decorating pastry tube for cream whipper	8,95
68405	R68400D	Tuerca roscada sifón	Support de douille à vis pour siphon	Screw part for cream whipper	3,55
68405	R68400F	Junta silicona sifón	Joint silicone pour siphon à chantilly	Silicone joint for cream whipper	3,55
68405	R68400G	Válvula inoxidable sifón	Soupape inox pour siphon à chantilly	St. steel valve for cream whipper	14,35
68405	R68400H	Escobilla limpieza sifón	Goupillon pour siphon à chantilly	Cleaning brush for cream whipper	4,70
68405	R68404A	Cabezal aluminio sifón	Tête complète en aluminium pour siphon	Aluminium head for cream whipper	63,80
68405	R68404D	Set boquillas+escobilla+porta cap.sifón	Ensemble pour siphon aluminium	Spare nozzles+brush+cap.holder alu cream	4,05
68405	R68500B	Jgo 6 pcs boquillas sifón crema	Set 6 pcs boquillas sifón crema	6 pcs cream whipper spare set	2,75
68500	R68500A	Cabezal plastico sifón crema	Tête complète en plastique pour siphon	Plastic cream whipper spare head	18,95
68500	R68500C	Junta silicona boquillas sifón crema	Joint silicone pour siphon à chantilly	Cream whipper spare silicone gasket	1,10
68500	R68500D	Set 3 juntas de silicona	Set 3 joint en silicone	3 piece ilicon joint set	6,10
68501	R68500A	Cabezal plastico sifón crema	Tête complète en plastique pour siphon	Plastic cream whipper spare head	18,95
68501	R68500C	Junta silicona boquillas sifón crema	Joint silicone pour siphon à chantilly	Cream whipper spare silicone gasket	1,10
68502	R68500A	Cabezal plastico sifón crema	Tête complète en plastique pour siphon	Plastic cream whipper spare head	18,95
68502	R68500C	Junta silicona boquillas sifón crema	Joint silicone pour siphon à chantilly	Cream whipper spare silicone gasket	1,10
68601	R68601A	Cabezal sifón soda 1 lts	Tete de la machine a soda 68601	Head set for soda maker 68601	31,55
68601	R68601B	Soporte carga de gas + tapon para 68601	Support de charge + capuchon pour 68601	Gas loading stand + cover for 68601	3,85
68601	R68601C	Botella para sifón soda 1 lts	Bouteille machine a soda 68601	Bottle for soda maker 68601	9,85
68604	R68604A	Cabezal sifón crema black	Tête complète pour siphon black	Black cream whipper spare head	18,95
68643	R68643A	Asa hervidor silbante white-black	Poignee bouillere sifflante white-black	Handle for whistling kettle white-black	4,25
68643	R68643B	Tapa hervidor silbante white-black	Couvercl bouillere sifflante white-black	id for whistling kettle white-black	2,15
68644	R68643A	Asa hervidor silbante white-black	Poignee bouillere sifflante white-black	Handle for whistling kettle white-black	4,25
68644	R68643B	Tapa hervidor silbante white-black	Couvercl bouillere sifflante white-black	id for whistling kettle white-black	2,15
68661	R68661A	Tapa tetera hierro fundido blue 1,1 l	Couvercle fer fondu blue theiere 1,1 l	id for cast iron blue tea pot 1,1 l	5,70
68661	R68661B	Filtro tetera hierro fundido blue 1,1 l	Filtere pour fer fondu blue theiere 1,1 l	Filter for cast iron blue tea pot 1,1 l	1,20
68662	R68662A	Tapa tetera hierro fundido 0,8 l	Couvercle fer fondu theiere 0,8 l	id for cast iron tea pot 0,8 l	2,35
68662	R68662B	Filtro tetera hierro fundido 0,8 l	Filtere pour fer fondu theiere 0,8 l	Filter for cast iron tea pot 0,8 l	1,20
68663	R68663A	Tapa tetera hierro fundido 0,25 l	Couvercle fer fondu theiere 0,25 l	id for cast iron tea pot 0,25 l	2,35
68663	R68663B	Filtro tetera hierro fundido 0,25 l	Filtere pour fer fondu theiere 0,25 l	Filter for cast iron tea pot 0,25 l	1,20
68664	R68664A	Tapa tetera hierro fundido 0,7 l	Couvercle fer fondu theiere 0,7 l	id for cast iron tea pot 0,7 l	2,35
68664	R68664B	Filtro tetera hierro fundido 0,7 l	Filtere pour fer fondu theiere 0,7 l	Filter for cast iron tea pot 0,7 l	1,20
68666	R68666A	Tapa tetera hierro fundido bamboo 0,6 l	Couvercle fer fondu bamboo theiere 0,6 l	id for cast iron tea pot bamboo 0,6 l	5,70
68666	R68666B	Filtr tetera hierro fundido bamboo 0,6 l	Filtere fer fondu bamboo theiere 0,6 l	Filter cast iron tea pot bamboo 0,6 l	1,20
68667	R68667A	Tapa tetera hierro fundido 0,5 l	Couvercle fer fondu theiere 0,5 l	id for cast iron tea pot 0,5 l	2,35
68667	R68667B	Filtro tetera hierro fundido 0,5 l	Filtere pour fer fondu theiere 0,5 l	Filter for cast iron tea pot 0,5 l	1,20
68668	R68668A	Tapa tetera hierro fundido black 0,8 l	Couvercle fer fondu black theiere 0,8 l	id for cast iron black tea pot 0,8 l	5,70
68668	R68668B	Filtro tetera hierro fundido black 0,8 l	Filtere fer fondu black theiere 0,8 l	Filter for cast iron black tea pot 0,8 l	1,20
68750	R68750A	Protector silicona moldes chapa antiad.	Protect.silicone poir moule patisserie	Bakeware silicone protector 1 pc.	4,60
68907	R68907	1 boquilla redonda 7 m.m. inox 18/10	1 douille unie 7mm inox 18/10	1plaintube 7 m.m. stainless steel 18/10	4,05
68927	R68927	1 boquilla estrella 7 m.m. inox 18/10	1 douille unie 7 mm inox 18/10	1star tube 7 m.m. stainless steel 18/10	4,05
68932	R68932	1 boquilla estrella 12 m.m. inox 18/10	1 douille unie 12 mm inox 18/10	1star tube 12 m.m. stainless steel 18/10	4,05
68948	R68948	1 boquilla rosa 8 m.m. inox 18/10	1 douille cannelée ferme 8 mm.	1 close star tube 8 m.m. stnls. 18/10	4,05
68974	R68974A	Adaptador para cabezal soplete gas 68984	adaptateur pour 68984torche caraméliser	Adapter for 68984 profes blow torch head	6,30
68989	R68989B	Tuerca+boquil.frontal pistola reposteria	Écrou+douille frontal pistolet patisser	Nut+front nozzle for cookie press cum	2,25
69000	R69015	Cubeta c/guías chafing roll top gn1/1	Bac avec gides pour chafing roll top 1/1	Container w/rails for roll top chafing	83,45
69001	R69001B	Tapa para chafing dish roll 69001	Couvercle pour 69001	id for 69001	205,55
69001	R69001C	Cubeta agua para chafing dish roll 69001	Eau bac pour 69001	Water container for 69001	60,55
69001	R69001D	Contenedor gel chafing dish gn 1/1-69001	Porte-bruleur bain marie gn 1/1 en inox	St steel gn 1/1 chafing-dish fuel holder	18,30
69001	R69001E	Asa de plastico para chafing 69001	Poignee pour bain marie rol top 69001	Plastic handle for chafing 69001	2,05
69001	R69015	Cubeta c/guías chafing roll top gn1/1	Bac avec gides pour chafing roll top 1/1	Container w/rails for roll top chafing	83,45
69002	R69002A	Resistencia calentadoras para 69002	Resistance de chauffage pour 69002	Heating resistance for 69002	55,95
69012	R69012A	Pomo regulador de temperatura	Bouto du regulateur de temperature	Temperature regulator knob	6,10
69004	R69015	Cubeta c/guías chafing roll top gn1/1	Bac avec gides pour chafing roll top 1/1	Container w/rails for roll top chafing	83,45
69012	R69012A	Pomo regulador de temperatura	Bouto du regulateur de temperature	Temperature regulator knob	6,10
69015	R69015	Cubeta c/guías chafing roll top gn1/1	Bac avec gides pour chafing roll top 1/1	Container w/rails for roll top chafing	83,45
69015	R69015A	Ejes laterales laton chafing dish 69015	Axes de laiton pour chafing dish 69015	69015 chafing dish left-right brass axes	30,30
69015	R69015B	Soporte quemadores gel chafing 69015	Support du brûleur pour chafing 69015	Fuel burner stand for chafing 69015	40,90
69018	69020	Cristal contenedor servidor de zumos	Bac pour distributeur de jus	Container for juice dispenser	62,70
69018	R69018	Grifo servidor de zumos-bebidas cal.	Robinet pour distributeur de jus	Faucet for juice dispenser	23,70
69018	R69018A	Tapa dispensador zumos pomo oro	Couvercle distributeur jus de fruit or	Gold knob juice dispenser lid	24,95
69018	R69018B	Bandeja goteo servidor zumos	Bac d egouttage pour 69018/69027	Drip tray for 69018/69027	40,00
69018	R69018C	Tubo hielo para 69018/69027	Tube de glace pour 69018/69027	Ice tube for 69018/69027	31,15
69018	R69027	Contenedor zumos brillo nuevo	Bac pour distributeur de jus en inox	Container for juice dispenser mirror sta	74,70
69022	R69022A	Tapa dispensador cereales	Couvercle pour distributeur de cereales	Cereal dispense lid w/knob	18,50
69022	R69022B	Cuerpo dispensador cereales	Réservoir acrylique pour distrib. cereal	Cereal dispenser tank	44,45
69022	R69022C	Ruleta girat. dispen. cereales	Système de rotation pour distrib. cereale	Revolving system for cereal dispenser	18,50
69022	R69022D	Ruleta goma dispensador de cereales	Roulette en caoutchouc pour distrib.cereale	Cereal dispenser rubber roulette	2,25
69022	R69022E	Compartimento inferior 69022	Recipiente inferior pour 69022	ower container for 69022	37,25
69023	R69022A	Tapa dispensador cereales	Couvercle pour distributeur de cereales	Cereal dispense lid w/knob	18,50
69023	R69022B	Cuerpo dispensador cereales	Réservoir acrylique pour distrib. cereal	Cereal dispenser tank	44,45
69023	R69022C	Ruleta girat. dispen. cereales	Système de rotation pour distrib. cereale	Revolving system for cereal dispenser	18,50
69023	R69022D	Ruleta goma dispensador de cereales	Roulette en caoutchouc pour distrib.cereale	Cereal dispenser rubber roulette	2,25



Ref.	Repuesto	Descripción	Description	Description	€	
69023	R69022E	Compartimento inferior 69022	Recipient inferieur pour 69022	Lower container for 69022	37,25	
69027	R69018	Grifo servidor de zumos-bebidas cal.	Robinet pour distributeur de jus	Faucet for juice dispenser	23,70	
69027	R69027	Contenedor zumos brillo nuevo	Bac pour distributeur de jus en inox	Container for juice dispenser mirror sta	74,70	
69027	R69027A	Tapa dispensador zumos pomo cromado	Couvercle distributeur jus de fruit chro	Chrome knob juice dispenser lid	24,95	
69027	R69027C	Rejilla goteo para dispensador de zumo	Goutte grille pour distributeur de jus	Drip grid for juice dispenser	11,40	
69028	R69028A	Tapa calenliq.patás cromadas	Couvercle pour 69028	Lid for 69028	11,20	
69030	R69030A	Cont. plast. dispensador leche 5.5 lts.	Plastique pour dispensateur de lait 5.5	Milk dispenser plastic ice container 5.5	5,60	
69030	R69030B	Base+filtro dispensador de leche inox	Stand+grille pour dispensateur de lait	Milk dispenser acrylic base+strainer	50,90	
69030	R69030C	Marmita disp. de leche inox 5.5 lts.	Marmite pour dispensateur de lait	St.st.5.5 lts. milk container	127,10	
69030	R69030D	Tapa dispensador de leche inox	Couvercle pour dispensateur de lait	Milk dispenser lid	17,80	
69030	R69030E	Grifo dispensador de leche inox	Robinet pour dispensateur de lait	Milk dispenser faucet	36,30	
69030	R69030F	Soprote inferior perforado dispens.leche	Base perforé pour dispensateur de lait	Milk dispenser slotted base	22,30	
	69032	R69032A	Placa control principal 69032	Bobine plaque à induction 69032	Ref. 69032 main control card	34,70
	69032	R69032B	Placa control botonera 69032	Plaque contrôle utilisation 69032	Ref.69032 buttons control card	20,75
	69032	R69032C	Ventilador placa induccion 69032	Ventilateur plaque à induction 69032	Ref. 69032 fan set	10,50
	69032	R69032D	Bobina induccion placa 69032	Bobine plaque à induction 69032	Ref.69032 induction coil	34,70
	69032	R69032E	Capacitadores placa induccion 69032	Capaciteur p/table cuisine induct. 69032	Capacitor for induction cooker 69032	3,55
	69032	R69032F	Placa control botonera v04 para 69033	Pcb v04 controle pour 69033	V04 control panel pcb for 69033	24,30
	69032	R69032G	Placa control botonera 09e-11 para 69033	Pcb 09e-v11 controle pour 69033	09e-v11 control panel pcb for 69033	24,30
	69032	R69032H	Placa control principal 09e 69032	Pcb 09e pour 69032	09e pcb for 69032	43,85
	69032	R69032J	Placa cristal induccion 69032	Plaque de verre pour 69032	Induction glass plate for 69032	70,90
	69033	R69033A	Elemento calentador. bobina	Bobine de chauffage arriere pour 69033	Rear heating coil for 69033	8,05
	69033	R69033B	Pcb bobina 1300w	Pcb pour bobine de chauffage arriere	Pcb for heating coil	18,50
	69033	R69033C	Pcb bobina 1800w	Pcb pour bobine de chauffage 1800w	Pcb for heating coil 1800w	47,80
	69033	R69033D	Placa control para 69033	Pcb controle pour 69033	Control pcb for 69033	16,10
	69033	R69033E	Ventilador para 69033	Ventilateur pour 69033	Fan for 69033	7,85
	69033	R69033F	Elemento calentador. bobina 1800w	Bobine de chauffage 1800w pour 69033	1800w heating coil for 69033	18,50
	69033	R69033G	Pcb general 69033	Pcb pour 69033	Contro pcbboard for 69033	22,60
	69034	R69015	Cubeta c/guías chafing roll top gn1/1	Bac avec gides pour chafing roll top 1/1	Container w/rails for roll top chafing	83,45
	69034	R69034A	Jgo. bisagra chafing dish 69034/69035	Jeu charnière pour chafing 69034/69035	Hinge set for chafing dish 69034/69035	5,00
	69035	R69034A	Jgo. bisagra chafing dish 69034/69035	Jeu charnière pour chafing 69034/69035	Hinge set for chafing dish 69034/69035	5,00
	69036	R69036A	Resistencia baño maria electrico	Electric bain-marie resistor	Resistance électrique bain.-marie	12,20
	69036	R69036B	Grifo baño maria	Robinet pour bain marie	Bain marie faucet	20,25
	69036	R69036C	Interruptor baño maria	Commutateur pour bain marie	Bain marie switch	1,95
	69036	R69036D	Pomo interruptor baño maria	Bouton commutateur pour bain marie	Bain marie switch knob	1,40
	69036	R69036E	Termostato baño maria	Thermostat pour bain marie	Bainmarie thermostat	17,10
	69036	R69036G	Conector ceramica 69036	Connecteur en céramique pour 69036	Ceramic connector for 69036	5,60
	69036	R69036H	Tubo drenaje agua baño maria electrico	Tuyau de vidange de l eau de 69036	Water drain pipe for 69036	12,40
	69036	R69036i	Junta silicona grifo para 69036	Joint en silicone robinet pour 69036	Silicone seal for faucet for 69036	4,05
	69037	R69037	Tapa para olla electrica	Couvercle pour electr.marmite buffet	Spare part lid for electric soup kettle	22,50
	69037	R69037A	Aro negro calentador sopa electrico	Anneau noir pour electr. marmite	Black color ring for electric soup kettl	25,25
	69037	R69037B	Repuesto contenedor aluminio+resistencia	Conteneur aluminium avec resistance elec	Aluminium cont. w/ heating torque assemb	27,25
	69037	R69037C	Sensor de temperatura para 69037	Capteur temperature pour 69037	Temperature sensor 69037	5,10
	69037	R69037D	Indicador luminoso para 69037	Voyant pour 69037	Indicator light for 69037	2,80
	69037	R69038	Termostato olla electrica	Simmerstato pour électrique marmite	Spare part simmerstato for el.soup kettel	36,10
	69037	R69039	Mando termostato olla electrica	Poignée pour simmerstato	Spare part simmerstato knob	25,45
	69037	R69040	Resistencia olla electrica 69037/ 69038	Resistance électrique pour ele.marmite	Spare part electrical resistance	17,30
	69038	R69037	Tapa para olla electrica	Couvercle pour electr.marmite buffet	Spare part lid for electric soup kettle	22,50
	69038	R69037B	Repuesto contenedor aluminio+resistencia	Conteneur aluminium avec resistance elec	Aluminium cont. w/ heating torque assemb	27,25
	69038	R69038	Termostato olla electrica	Simmerstato pour électrique marmite	Spare part simmerstato for el.soup kettel	36,10
	69038	R69038A	Aro inoxidable calentador sopa electrico	Anneau inox pour electr. marmite	St. steel ring for electric soup kettle	20,05
	69038	R69039	Mando termostato olla electrica	Poignée pour simmerstato	Spare part simmerstato knob	25,45
	69038	R69040	Resistencia olla electrica 69037/ 69038	Resistance électrique pour ele.marmite	Spare part electrical resistance	17,30
	69039	R69039	Mando termostato olla electrica	Poignée pour simmerstato	Spare part simmerstato knob	25,45
	69040	R69040A	Motor-bomba maq.vacio profesional 40 cms	Moteur machine sous vide professionnelle	Motor-pump professional vacuum machine	135,65
	69040	R69040B	Set sellado para maquina vacio 69040	Set etancheite pour sous vide 69040	Sealing set for vacuum machine 69040	39,30
	69040	R69040C	Placa control + display para 69040	Panneau de contrôle + affichage 69040	Pcboard+ display for 69040	184,55
	69040	R69040E	Etiqueta placa control para 69040	Etiquette panneau de contrôle 69040	Pcboard sticker for 69040	12,20
	69045	R69045A	Regulador de temperatura placa 69045	Regulateur temp. plaque de réchauffement	Temperatura regulator for warming plate	6,70
	69049	R69049A	Tapa compartimento maq.vacio maxi 120 w	Couverc.compart.maxi mach.sous vide 120w	Spare cover for maxi vacuum machine 120w	7,00
	69049	R69049B	Placa de control maq.vacio maxi 120 w	Tableau command maxi mach.sous vide 120w	Pc board for maxi vacuum machine 120w	36,75
	69049	R69049C	Cubierta tapa maquina vacio maxi 120 w	Couverture maxi mach.sous vide 120w	Lower cover for maxi vacuum machine 120w	7,55
	69049	R69049D	Motor para maquina de vacio 120 w	Moteur mach.sous vide 120w	Engine for maxi vacuum machine 120w	12,30
	69049	R69050A	Cinta teflon maquina vacio hogar	Bande teflon pour machine souds visde	Teflon string for home vacuum pack	2,65
	69049	R69050B	Hilo resistencia máquina vacio hogar	Resistance scellage pour machine souds v	Resistance for home vacuum pack	0,60
	69049	R69050F	Adaptador maquina vacio hogar	Adaptateur pour recipients pour machine	Home vacuum pack adapter	3,35
	69049	R69049N	Tubo neumatico maquina vacio maxi	Tube pneumatique pour 69049	Pneumatic tube for 69049	1,10

Ref.	Repuesto	Descripción	Description	Description	€
	69050 R69050A	Cinta teflon maquina vacio hogar	Bande teflon pour machine souds visde	Teflon string for home vacuum pack	2,65
	69050 R69050B	Hilo resistencia máquina vacio hogar	Resistance scellage pour machine souds v	Resistance for home vacuum pack	0,60
	69050 R69050C	Almohadilla vacio superior vacio hogar	Coussin vide superieur pour machine	Upper foam for home vacuum pack	2,75
	69050 R69050D	Almohadilla vacio inferior vacio hogar	Coussin vide inferieur pour machine	Bottom foam for home vacuum pack	2,25
	69050 R69050E	Goma sellado maquina vacio hogar	Caoutchouc scellage pour machine	Rubber tube for home vacuum pack	2,15
	69050 R69050F	Adaptador maquina vacio hogar	Adaptateur pour recipients pour machine	Home vacuum pack adapter	3,35
	69050 R69050G	Tapa recipiente maq. vacio hogar	Couvercle recipient pour machine souds	id for home vacuum pack canister	5,60
	69050 R69050H	2 pulsador later+4pies goma+41 tornillos	2 bouton+4 pie a caoutchouc+41 vis	2 side bottoms+4rubber feet+41 screws	3,35
	69050 R69050J	Tarjeta control maquina vacio domestica	Carte digital pour machine souds visde h	Household vacuum machine control card	24,40
	69050 R69050K	Bomba succion maquina vacio domestica	Pompe de succion pour machine souds visd	Household vacuum machine suction pump	12,30
	69050 R69050I	Tapa principal maq.vacio domestica	Couvercle pour machine souds visde home	Household vacuum machine main cover	11,70
	69050 R69050N	Tubo neumatico maquina vacio hogar	Tube pneumatique pour 69050	Pneumatic tube for 69050	0,80
	69060 R69060A	Bandeja recogemigas tost. ranura larga	Plateau ramasse-miettes grille-pain rain	Electric long toaster crumbs tray	1,40
	69060 R69060B	Parrilla calen. tostadora ranura larga	Grille chauffage toasteur rainure longue	Electric long toaster bread grill	1,10
	69061 R69061A	1 ampa infrarrojos 275 w	1 ampe infrarouge 275 w	275 w infrared heating bulb	7,85
	69061 R69061B	Set repuestos 69061	Pièces set pour 69061	Spare part set for 69061	5,80
	69062 R69062A	Bandeja recogemigas tostada. 2-4 ranuras	Plaque à ramasse-miettes pour grille-pai	2-4 pop-up toaster crumbs tray	7,20
	69062 R69062B	Repuesto pzas tostadoras 2-4 ranuras	Pièces détachée p. grille-pain 2-4 tranc	2-4 pop-up toaster small parts	3,65
	69063 R69063A	Cuchilla picadora electrica 320 w	1 ame hachoir électrique 300 w	320 w. electric mincer blade	1,95
	69063 R69063B	2 tapas transp.+negra pic. elec.320w	2 couvercles transp.+noire hachoir 320w	320 w black electric mincer+2 trans.lids	1,55
	69063 R69063C	Contenedor cristal para 69063	Cristaux conteneur pour 69063	Glass container for 69063	15,65
	69063 R69063D	Motor para 69063	Moteur pour 69063	Motor for 69063	40,30
	69064 R69062A	Bandeja recogemigas tostada. 2-4 ranuras	Plaque à ramasse-miettes pour grille-pai	2-4 pop-up toaster crumbs tray	7,20
	69064 R69062B	Repuesto pzas tostadoras 2-4 ranuras	Pièces détachée p. grille-pain 2-4 tranc	2-4 pop-up toaster small parts	3,65
	69065 R69065A	Bandeja recogemigas horno 1.34 kw	Plateau recueil-miettes p/conveyeur 1.34	Crumb collection tray oven conveyer 1.34	15,55
	69065 R69065B	Rejilla entrada horno conveyor 1.34 kw	Grille entrée pour conveyeur 1.34 kw	Oven entrance grill conveyer 1.34 kw	8,75
	69065 R69065C	Pata apoyo horno conveyor 1.34 kw	Pied appui pour conveyeur 1.34 kw	Oven leg support conveyer 1.34 kw	15,55
	69065 R69065D	Tapa posterior horno conveyor 1.34kw	Couvercle postérieur pour conveyeur 1.34	St.steel rear oven lid conveyer 1.34 kw	15,55
	69065 R69065E	Bandeja recogida post. horno 1.34 kw	Plateau recueil post grille-pain 1.34	Rear toaster collection tray con. 1.34	22,30
	69065 R69065F	Rampa rec. tostadora conveyor 1.34 kw	Rampe recueil grille-pain conveyeur 1.34	St.steel toaster col. ramp 1.34 kw	37,85
	69065 R69065G	Resistencia superior 69065 - 0,7 w	Resistor superieure 69065 - 0,7 w	Heat element top 69065 - 0,7 w	44,05
	69065 R69065H	Resistencia inferior 69065 - 0,6 w	Resistor inferieure 69065 - 0,6 w	Heat element upper 69065 - 0,6 w	32,25
	69065 R69065J	Motor para tostadora 69065 y 69066	Moteur pour 69065 o 69066	Motor for 69065 and 69066	159,75
	69065 R69065K	Interruptor de velocidad para 69065-6	Commutateur de vitesse pour 69065-6	Speed control for 69065-6	31,05
	69065 R69066J	Regulador termostato para 69066	Regulateur de thermostat pour 69066	Thermostat regulator for 69066	27,90
	69065 R69065I	Selector de calentamiento para 69065-6	Interrupteur chaleur pour 69065-6	Heat switch for 69065-6	65,00
	69065 R69065M	Ventilador para 69065	Ventilateur pour 69065	Fan for 69065	22,30
	69066 R69065C	Pata apoyo horno conveyor 1.34 kw	Pied appui pour conveyeur 1.34 kw	Oven leg support conveyer 1.34 kw	15,55
	69066 R69065J	Motor para tostadora 69065 y 69066	Moteur pour 69065 o 69066	Motor for 69065 and 69066	159,75
	69066 R69065K	Interruptor de velocidad para 69065-6	Commutateur de vitesse pour 69065-6	Speed control for 69065-6	31,05
	69066 R69066A	Bandeja recogemigas horno 2.24 kw	Plateu recueil-miettes p/conveyeur 2.24	Crumb collection tray oven conveyor 2.24	20,55
	69066 R69066B	Rejilla entrada horno conveyor 2.24 kw	Grille entrée pour conveyeur 2.24 kw.	Oven entrance grill conveyer 2.24 kw	10,70
	69066 R69066D	Tapa posterior horno conveyor 2.24 kw	Couvercle postérieur pour conveyeur 2.24	St.steel rear oven lid conveyer 2.24 kw	20,55
	69066 R69066E	Bandeja rec. post. tostadora 2.24 kw	Plateau recueil post. grille-pain 2.24kw	Rear toaster col. tray conveyer 2.24 kw	28,90
	69066 R69066F	Rampa rec. tostadora conveyor 2.24 kw	Rampe recueil grille-pain conveyeur 2.24	St.steel toaster collection ramp 2.24kw	55,65
	69066 R69066G	Resistencia superior 69066 - 1,3 w	Resistor superieure 69066 - 1,3 w	Heat element top 69066 - 1,3 w	38,95
	69066 R69066H	Resistencia inferior 69066 - 0,9 w	Resistor inferieure 69066 - 0,9 w	ower heat element 69066 - 0,9 w	38,95
	69066 R69066J	Regulador termostato para 69066	Regulateur de thermostat pour 69066	Thermostat regulator for 69066	27,90
	69066 R69065I	Selector de calentamiento para 69065-6	Interrupteur chaleur pour 69065-6	Heat switch for 69065-6	65,00
	69066 R69066M	Ventilador para 69066	Ventilateur pour 69066	Fan for 69066	22,30
	69067 R69067A	Bandeja picadora de carne domestica 700w	Plateau hachoir à viande domestique 700w	700 w domestic meat mincer tray	12,10
	69067 R69067B	Tubo "t" picadora carne domestica 700 w	Tube "t" hachoir à viande domestique 700	700 w domestic meat mincer "t" pipe	17,40
	69067 R69067C	Husillo picadora carne domestica 700 w	Tige hachoir à viande domestique 700 w	700 w domestic meat mincer screw	8,65
	69067 R69067D	Empujador+llave picad. carne dom. 700 w	Poussoir+clé hachoir à viande domes 700w	700 w meat mincer key+plunger	1,10
	69067 R69067E	Tuerca picadora carne domestica 700 w	Écrou hachoir à viande domestique 700 w	700 w domestic meat mincer nut	0,50
	69067 R69067G	Disco grueso 8 mm. pic. carne dom. 700 w	Disque épais 8 mm. hachoir à viande 700w	700 w domestic meat mincer d.8mm. thickd	7,75
	69067 R69067H	Disco medio 5mm. picad.carne dom. 700 w	Disque moyen 5 mm. hachoir à viande 700w	700 w domestic meat mincer d.5mm m.disc	7,75
	69067 R69067J	Disco fino d3 mm picad. carne dom 700 w	Disque fin d.3 mm. hachoir à viande 700w	700 w dom. meat mincer 3 mm fine disc	7,75
	69067 R69067K	Motor para 69067	Moteur pour 69067	Motor for 69067	127,80
	69068 R69068A	Bandeja picadora electrica de carne	Plateau hachoir électrique pour viande	Food tray for meat grinder	28,10
	69068 R69068B	Tubo t picadora electrica de carne	T tube hachoir électrique pour viande	Alum. cutting t housing meat grinder	19,15
	69068 R69068C	Husillo picadora electrica de carne	Broche hachoir électrique pour viande	Meat grinder helix	9,95
	69068 R69068D	Empujador+accesorios pic. electr.carne	Poussoir+access.hachoir élec.viande	Meat grinder pusher+accessories	4,50
	69068 R69068E	Tuerca picadora electrica de carne	Écrou hachoir électrique pour viande	Meat grinder nut	4,50
	69068 R69068F	Cuchilla picadora electrica de carne	1 amé hachoir électrique pour viande	Meat grinder blade	4,50
	69068 R69068G	Disco grueso picadora electrica de carne	Disque épaisse hachoir élec. pour viande	Meat grinder coarse grinding disk	5,00
	69068 R69068H	Disco mediano picadora elec. de carne	Disque médium hachoir élec.pour viande	Meat grinder medium grinding disk	4,50
	69068 R69068J	Disco fino picadora electrica de carne	Disque fine hachoir élec.pour viande	Meat grinder fine grinding disk	5,20
	69068 R69068K	Engranaje de helice+tornillo+arandela	Écrou à borche + vis+ rondelle	Spindle nut + screw + plain washer	2,65
	69068 R69068I	Engranajes para 69068	Pignon pour 69068	Gear for 69068	5,60
	69068 R69068M	Placa control para picadora 69068	Commission de contrôle de moulin 69068	Control boar for grinder 69068	13,15
	69068 R69068N	Engranaje helice para 69068	Vitesse de helice pour 69068	Propeller gear for grinder 69068	8,55
	69068 R69068P	Juego de arandelas para 69068	Rondelle set pour 69068	Washer set for 69068	5,10
	69068 R69068Q	Engranaje aux. Para 69068	Pignon aux. Pour 69068	Aux. Gear for 69068	8,95



Ref.	Repuesto	Descripción	Description	Description	€
69069	R69069A	Rallador grueso picadora electr. carne	Râpe gros pour hachoir elec. pour viande	Grater accesorie coarse bar cutter	0,00
69069	R69069B	Rallador fino picadora electr. carne	Râpe fine pour hachoir élec. pour viande	Grater accesorie fine bar cutter	5,60
69069	R69069C	Cortador rodaja picadora electr. carne	Râpe rondelles pour hachoir électrique	Grater accesorie slicer bar cutter	5,60
69069	R69069D	Empujador+sop. rallador picadora carne	Pousseur+support hachoir électrique	Grater accesorie pusher+housing	2,75
	69070	R69070A Bandeja recogeaguas refrigerador	Plateau récupérateur d'eau pour 69070	Tray for water for 69070	2,15
	69070	R69070B Bandeja cubos hielo refrigerador	Plateau pour glaçon 69070	Ice cube tray for 69070	2,15
	69070	R69070C Parrilla refrigerador mini-bar	Grill pour 69070	Grill for 69070	3,45
	69070	R69070D Termostato refrigerador mini-bar	Thermostat pour 69070	Thermostat for 69070	3,45
	69070	R69070E Pies de goma refrigerador (4 pcs.)	Pied en caoutchouc pour 69070 (4 pcs.)	Rubber feet for 69070 (4 pcs.)	3,05
	69070	R69070F Ventilador refrigerador mini-bar	Ventilateur pour 69070	Fan set for 69070	4,70
	69070	R69070G Placa control refrigerador mini-bar	Plaque au controle pour 69070	Control card for 69070	6,00
	69070	R69070H Tapa placa control refrig. mini-bar	Couvercle pour plaque du control p.69070	Control card cover+fan for 69070	39,60
	69070	R69070J Cable conexion refrigerador mini-bar	Câble branchement pour 69070	Power cord for 69070	6,00
	69070	R69070K Bloque enfriador mini bar 70w	Bloc refroidisseur pour mini bar 70 w	Cooling system for mini refrigerator 70w	34,50
	69070	R69070L Ventilador trasero para mini bar	Arriere ventilateur pour 69070	Rear fan set for 69070 mini refrigerator	4,70
	69071	R69071 Tarjeta luz inter. arm. 8-16-28-48 bot.	Carte lumière p/refroid. vin 8-16-28-48	Inter. light card 8-16-28-48 b. wine cel	5,00
	69071	R69071B Bloque enfriador arm. 16 y 48 botellas.	Bloc refroidisseur p/refroid. 16-48 bou	Cooling system f/16-48 bott. wine cellar	64,50
	69071	R69071C Pasamanos armario refrig.vino 16 bot.	Poignée refroidis. à vin électr.16 bout.	16 bot.wine cella handlebar	5,00
	69071	R69071D Parrilla 4 bot. arm. 16 botellas	4 bou. grill pour refr. à vin élec.16 b	4 bot. grill for 16 bottles wine cell	18,70
	69071	R69071E Bisagra inferior puert. arm. 8-16-28 bot	Charnière inferieur p/refroid. 8-16-28 b	Down door ream f/8-16-28 bott. wine cell	3,15
	69071	R69071G Cable+enchufe arm. 8-16-28-48 bot.	Câble+prise p/ 8-16-28-48 ref. à vin	Cable+plug for 8-16-28-48 bo wine cellar	8,25
	69071	R69071H Ventilador aire caliente arm. 16 bot.	Ventilate. air chaud p/refro. elec. 16 b	Heat air ventilat. f/16 bott. wine cell.	20,95
	69071	R69071I Tarjeta contr. temp+carat. 8-16-28-48 bo	Tempér. carte pour refr. 8-16-28-48 bout	Temp. card f/8-16-28-48 bot. wine cellar	11,20
	69071	R69071M Bisagra superior puerta arm. 8-16-28 bot	Charnière superieure p/refro. 8-16-28 bo	Top hinge f/8-16-28 bott. wine cellar	3,15
	69071	R69071N Bandeja recoge aguas arm. 16 bot.	Plateau à eau p/refr. à vin elec. 16 bou	Tray for water for 16 bott. wine cellar	2,05
	69071	R69071P Set 2 patas arm. refrig. 16 - 28 bot.	Set 2 pieds p/refroid. à vin 16-28 bout.	Set 2 rubber foots f/16-28 bott. wine ce	0,70
	69071	R69071R Ventilador aire frio arm. 16 bot.	Ventilateur air froid p/refroid. 16 bout	Fan cold air f/16 bott. wine cellar	7,00
	69071	R69071S Puerta de cristal arm. refrig. 16 bot.	Porte vitree p/refroid. à vin 16 bout.	Glass door f/ 16 bott. wine cellar	53,70
	69071	R69072A Tarjeta contr. arm. ref. vino 8-16-28-48	Carte digital p/refroid. 8-16-28-48 bout	Wine cellar control card 8-16-28-48	30,40
	69072	R69071 Tarjeta luz inter. arm. 8-16-28-48 bot.	Carte lumière p/refroid. vin 8-16-28-48	Inter. light card 8-16-28-48 b. wine cel	5,00
	69072	R69071E Bisagra inferior puert. arm. 8-16-28 bot	Charnière inferieur p/refroid. 8-16-28 b	Down door ream f/8-16-28 bott. wine cell	3,15
	69072	R69071G Cable+enchufe arm. 8-16-28-48 bot.	Câble+prise p/ 8-16-28-48 ref. à vin	Cable+plug for 8-16-28-48 bo wine cellar	8,25
	69072	R69071I Tarjeta contr. temp+carat. 8-16-28-48 bo	Tempér. carte pour refr. 8-16-28-48 bout	Temp. card f/8-16-28-48 bot. wine cellar	11,20
	69072	R69071M Bisagra superior puerta arm. 8-16-28 bot	Charnière superieure p/refro. 8-16-28 bo	Top hinge f/8-16-28 bott. wine cellar	3,15
	69072	R69071P Set 2 patas arm. refrig. 16 - 28 bot.	Set 2 pieds p/refroid. à vin 16-28 bout.	Set 2 rubber foots f/16-28 bott. wine ce	0,70
	69072	R69072A Tarjeta contr. arm. ref. vino 8-16-28-48	Carte digital p/refroid. 8-16-28-48 bout	Wine cellar control card 8-16-28-48	30,40
	69072	R69072B Bloque enfriador arm. 28 bot.	Bloc refroidisseur p/refroid. 28 bout.	Cooling system f/28 bott. wine cellar	72,25
	69072	R69072C Pasamanos armario refrig.vino 28 bot	Poignée refroidis.a vin electr.28bot	28 bot. wine cellar handlebar	6,90
	69072	R69072D Parrilla 4 bot. arm. refri. 28 botellas	4 boutei. grill p/refroid. élec. 28 bout.	4 bott. grill f/28 bott. wine cellar	4,60
	69072	R69072E Junta silicona puerta para 69072	Joit d etancheite porte pour 69072	Door sealing gasket for 69072	20,15
	69072	R69072F Sensor de temperatura para 69072	Capteur temperature pour 69072	Temperature sensor 69072	7,20
	69072	R69072H Ventilador aire caliente arm. 28 bot.	Ventilateur air chaud p/refroid. 28 bout	Fan heat air f/28 bott. wine cellar	6,10
	69072	R69072S Puerta de cristal arm. refrig. 28 bot.	Porte vitree p/refroid. à vin 28 bout.	Glass door for 28 bott. wine cellar	65,30
	69072	R69078R Ventilador aire frio arm. 8 - 28 botell.	Ventilateur air froid p/refroid 8-28 bou	Fan cold air f/8 - 28 bott. wine cellar	24,50
	69074	R69071 Tarjeta luz inter. arm. 8-16-28-48 bot.	Carte lumière p/refroid. vin 8-16-28-48	Inter. light card 8-16-28-48 b. wine cel	5,00
	69074	R69071B Bloque enfriador arm. 16 y 48 botellas.	Bloc refroidisseur p/refroid. 16-48 bou	Cooling system f/16-48 bott. wine cellar	64,50
	69074	R69071G Cable+enchufe arm. 8-16-28-48 bot.	Câble+prise p/ 8-16-28-48 ref. à vin	Cable+plug for 8-16-28-48 bo wine cellar	8,25
	69074	R69071I Tarjeta contr. temp+carat. 8-16-28-48 bo	Tempér. carte pour refr. 8-16-28-48 bout	Temp. card f/8-16-28-48 bot. wine cellar	11,20
	69074	R69072A Tarjeta contr. arm. ref. vino 8-16-28-48	Carte digital p/refroid. 8-16-28-48 bout	Wine cellar control card 8-16-28-48	30,40
	69074	R69074A Placa de control para 69074	Pcb controle pour 69074	Control pcb for 69074	26,05
	69074	R69074C Pasamanos armario refrig.vino 48 bot	Poignée refroidis a vin electr.48 bot	48 bot.wine cellar handlebar	7,75
	69074	R69074D Parrilla 3 bot. arm. 48 botellas	3 bou. grill pour refr. à vin élec. 48 b	3 bot. grill for 48 bot. wine cellar	5,00
	69074	R69074E Bisagra inferior arm. 48 botellas	Charnière inferieur p/refr. à vin 48 bou	Door inferior hinge f/48 bott. wine cell	3,15
	69074	R69074M Bisagra superior arm. 48 botellas	Charnière sup.+ couv. p/refroid. vin 48	Door superior hinge+lid f/48 bott. wine	3,35
	69074	R69074N Bandeja recoge aguas arm. 48 botellas	Plateau pour eau p/ref. à vin éléc.48bou	Tray for water for 48 bot. wine cellar	5,00
	69074	R69074R Ventilador aire frio arm. 48 bot.	Ventilateur air froid p/refroid. 48 bout	Fan cold air f/48 bott. wine cellar	6,10
	69074	R69074S Puerta cristal izqda. arm. refri. 48 bo.	Porte vitree gauche p/ refroid. 48 bout.	Left glass door f/48 bott. wine cellar	84,45
	69074	R69074T Puerta cristal dcha. arm. refrig. 48 bot	Porte vitree droite p/refroid. 48 bout.	Right glass door f/48 bott. wine cellar	84,45
	69074	R69078P Set 2 patas armario refrig. 8 - 48 bot.	Set 2 pieds p/refroid. à vin 8-48 bout.	Set 2 rubber foots f/8 - 48 bott. wine c	2,45
	69075	R69070A Bandeja recogeaguas refrigerador	Plateau récupérateur d'eau pour 69070	Tray for water for 69070	2,15
	69075	R69070B Bandeja cubos hielo refrigerador	Plateau pour glaçon 69070	Ice cube tray for 69070	2,15
	69075	R69070C Parrilla refrigerador mini-bar	Grill pour 69070	Grill for 69070	3,45
	69075	R69070D Termostato refrigerador mini-bar	Thermostat pour 69070	Thermostat for 69070	3,45
	69075	R69070E Pies de goma refrigerador (4 pcs.)	Pied en caoutchouc pour 69070 (4 pcs.)	Rubber feet for 69070 (4 pcs.)	3,05
	69075	R69070F Ventilador refrigerador mini-bar	Ventilateur pour 69070	Fan set for 69070	4,70
	69075	R69070G Placa control refrigerador mini-bar	Plaque au controle pour 69070	Control card for 69070	6,00
	69075	R69070H Tapa placa control refrig. mini-bar	Couvercle pour plaque du control p.69070	Control card cover+fan for 69070	39,60
	69075	R69070J Cable conexion refrigerador mini-bar	Câble branchement pour 69070	Power cord for 69070	6,00
	69075	R69070K Bloque enfriador mini bar 70w	Bloc refroidisseur pour mini bar 70 w	Cooling system for mini refrigerator 70w	34,50
	69078	R69071 Tarjeta luz inter. arm. 8-16-28-48 bot.	Carte lumière p/refroid. vin 8-16-28-48	Inter. light card 8-16-28-48 b. wine cel	5,00
	69078	R69071E Bisagra inferior puert. arm. 8-16-28 bot	Charnière inferieur p/refroid. 8-16-28 b	Down door ream f/8-16-28 bott. wine cell	3,15
	69078	R69071G Cable+enchufe arm. 8-16-28-48 bot.	Câble+prise p/ 8-16-28-48 ref. à vin	Cable+plug for 8-16-28-48 bo wine cellar	8,25







Ref.	Repuesto	Descripción	Description	Description	€
69078	R69071i	Tarjeta contr. temp+carat. 8-16-28-48 bo	Tempér. carte pour refr. 8-16-28-48 bout	Temp. card f/8-16-28-48 bot. wine cellar	11,20
69078	R69071M	Bisagra superior puerta arm. 8-16-28 bot	Charnière superieure p/refro. 8-16-28 bo	Top hinge f/8-16-28 bott. wine cellar	3,15
69078	R69072A	Tarjeta contr. arm. ref. vino 8-16-28-48	Carte digital p/refroid. 8-16-28-48 bout	Wine cellar control card 8-16-28-48	30,40
69078	R69074H	Ventilador aire caliente arm. 8 - 48 bot	Ventilateur air chaud 8-48 bout. + conec	Fan heat air 8 - 48 bott. + conec. male	10,90
69078	R69078A	Placa control temperatura para 69078	Température pcb controle pour 69078	Temperature control pcb for 69078	21,25
69078	R69078B	Bloque enfriador arm. 8 bot.	Bloc refroidisseur p/refroid. 8 bout.	Cooling system f/8 bott. wine cellar	59,75
69078	R69078C	Tirador puerta armario refrig. 8 bot.	Poignée refroidis a vin electr. 8 bot.	8 bottles wine cellar handlebar	9,95
69078	R69078D	Parrilla 2 bot. arm. 8 botellas	2 bout. grill pou ref. à vin élec. 8 bou	2 bot. grill for 8 bot. wine cellar	5,00
69078	R69078N	Bandeja recoge aguas arm. 8 botellas	Plateau ramassage d'eau p/refroid. 8 bou	Tray for water f/8 bott. wine cellar	2,35
69078	R69078P	Set 2 patas armario refrig. 8 - 48 bot.	Set 2 pieds p/refroid. à vin 8-48 bout.	Set 2 rubber foots f/8 - 48 bott. wine c	2,45
69078	R69078Q	2 tornillos tirador armario refrigerador	2 vis pour poignée refroidis a vin elect	2 bolts for wine cellar handlebar	0,70
69078	R69078R	Ventilador aire frio arm. 8 - 28 botell.	Ventilateur air froid p/refroid 8-28 bou	Fan cold air f/8 - 28 bott. wine cellar	24,50
69078	R69078S	Puerta de cristal arm. refrig. 8 bot	Porte vitree p/refroid. 8 bouteilles	Glass door for 8 bott. wine cellar	38,35
69079	R69079A	Jarra 1.5 lts robot multifuncional	jarre bol 1,5 lts robot multifonction	Multifunctional robot 1.5 lts bowl	7,75
69079	R69079B	Jarra batidora robot multifuncional	Jarre en verre bleder robot multifonctio	Multifunctional robot full blender jug	11,70
69079	R69079C	Molinillo+tapa robot multifuncional	Moulin+couvercle robot multifonction	Multifunctional robot mill+cover	6,40
69079	R69079D	Jgo mini picador robot multifuncional	Ensemble mini hachoir robot multifonctio	Multifunctional robot mini chopper set	4,70
69079	R69079E	Espatula+eje robot multifuncional	Spatule+ axe robot multifonction	Multifunctional robot spatula+main axis	1,00
69079	R69079F	Conjunto licuador robot multifuncional	Ensemble centrifugeuse robot multifoncti	Multifunctional robot fruit juicer set	6,60
69079	R69079G	Conjunto exprimidor robot multifuncional	Ensemble presse-fruits robot multifonctio	Multifunctional robot squeezer set	2,35
69079	R69079H	Conjunto batidor-montador robot multifun	Ensemble batteur- foueter robot multifon	Multifunctional robot twin whisk set	3,35
69079	R69079J	Tapa jarra 1.5 lts robot multifuncional	Couvercle jarre 1,5 lts robot multifonct	Multifunctional robot 1.5 lts bowl lid	4,25
69079	R69079i	Juego 3 cuchillas robot multifuncional	Ensemble 3 lame robot multifonction	Multifunctional robot 3 blades set	6,10
69079	R69079M	Disco rallador grueso+tronzador 4 mm	Disque rape gros+ coupeur 4 mm	Coarse grater+4 mm slicer cutting disc	3,55
69079	R69079N	Disco rallador robot multifuncional	Disque rape robot multifonction	Mult.robot mill grater cutting disc	3,25
69079	R69079P	Disco rallador fino+tronzador 2 mm	Disque rape fine + coupeur 2 mm	Fine grater+2 mm slicer cutting disc	3,55
69079	R69079Q	Disco corte chips robot multifuncional	Disque rape chips robot multifonction	Mult.robot chips cutting disc	3,85
69079	R69079R	Set switch para robot multifuncion	Set contacteur pour multifonction robot	Switch set for multifunction robot	4,05
69079	R69079S	Placa control robot multifuncion	Carte de commande robot multifonction	Pc board multifunction robot	5,60
69079	R69079W	Conjunt motor control robot multifuncion	Moteur pour robot multifonction	Engine for multifunction robot	62,45
69080	R69080B	Filtro exprimidor electrico 85w	Filtre pour presse-fruits 85w	85w orange juicer filter	3,35
69080	R69080D	Tapa exprimidor electrico 85w	Couvercle pour presse-fruits 85w	85w orange juicer lid	3,35
69081	R69081A	Jarra cristal 1.6 lts. batidora	Jarre en verre pour mixer 1.6 lts.	1.6 lts. blender glass jug	19,65
69081	R69081B	Conj.motor batidora electr.1.6 lts.	Moteur pour mixer électrique 1.6 lts.	1.6 lts. blender electrical set	36,75
69081	R69081C	Motor jarra batidora 500w	Moteur pour mixer a/jarre en verre 500w	500w blender motor	31,15
69081	R69081D	Tapa jarra batidora electric.1.6 lts.	Couvercle pour mixer électrique 1.6 lts.	1.6 lts. blender cover	8,45
69081	R69081E	Acople motor batidor 69081	Moteur adapteur à batteur 69081	Motor connection part for blender 69081	0,90
69081	R69081F	Conjunto cuchilla batid.jar.crist. 69081	Ensemble lame mixer pour 69081	Set of blade for blender 69081	5,70
69082	R69082A	Cono licuadora fruta+batid.800w	Cône inox pour centrifugeuse+blender 800	800w fruit proceessor st. steel cone	8,95
69082	R69082B	Mando licuadora fruta+batidora 800w	Commande pour centrifugeuse+blender 800w	800w fruit proceessor switch	3,35
69082	R69082C	Motor licuadora fruta+batidora 800w	Moteur pour centrifugeuse+blender 800w	800w fruit proceessor motor	37,85
69082	R69082D	Cabecal transparente licuadora 800w	Couvercle pour centrifugeuse+blender 800	800w fruit processor transparent cover	5,10
69082	R69082E	Jarra cristal licuadora+batidora 800 w	Jarre en verre pour centrif+blender 800w	800w fruit process+blender glass jug	46,60
69082	R69082F	Tapa jarra licuadora+batidora 800 w	Couvercle pour centrifugeuse+blender 800	800 w fruit process+blender jug cover	2,25
69082	R69082G	Contenedor desper.licuad.+batid 800w	Bac à déchets pour centrifugeuse+blen800w	800 w fruit process+blender waste cont.	3,35
69082	R69082H	Pisador fruta licuadora+batidora 800 w	Pousser en plastic pour centrif+blen800w	800 w fruit process+blender pusher	2,75
69082	R69082J	Jarra zumo licuadora+batidora 800 w	Carafe en plastic pour centrif+blen 800w	800 w fruit process+blender juice jug	4,60
69082	R69082K	Conj.motor licuadora+batidora 800 w	Ensemble motor pour centr.+blender 800w	800 w fruit process+blender motor set	111,20
69082	R69082i	Bloque interm.licuadora+batidora 800w	Ensemble intermede pour centrif.+blen800w	800 w fruit process+blender middle part	26,25
69082	R69082M	Acople motor batidor 69082	Moteur adapteur à batteur 69082	Motor connection part for blender 69082	1,85
69083	R69083A	Juego 2 varillas batidoras	Jeu de 2 batteurs	St.steel beaters hooks set	5,90
69083	R69083B	Juego 2 varillas amasadoras	Jeu de 2 malaxeurs	St.steel dough hooks set	5,90
69083	R69083C	Bol inox batidora electrica	Bol fouet-mélangeur électrique	St.steel mixer bowl	22,30
69083	R69083D	Soporte batidora electrica	Support fouet-mélangeur électrique	Electrical mixer stand	17,30
69083	R69083E	Motor batidora-mezcladora domest.250w	Moteur pour fouet-mélangeur électr.250 w	Motor for electrical table mixer 250 w	22,80
69084	R69084A	Bol inox 5 lts. batidora-amasadora 300 w	Bol inox 5 l. mixeur-pétrisseur - 300 w.	5 lts. st. steel bowl for 300 w. mixer	50,05
69084	R69084B	Varilla batidora batidora-amasadora 300w	Fouet batteur mixeur-pétrisseur 300 w.	Rod blender blender-kneader 300 w.	17,40
69084	R69084C	Varilla mezcladora batidora-amas. 300 w.	Fouet mélangeur mixeur pétrisseur 300 w.	Mixer rod blender-kneader 300 w.	17,40
69084	R69084D	Varilla amasadora batidora-amas. 300 w	Fouet pétrisseur mixeur pétrisseur 300 w	Kneader blender rod kneader 300 w.	60,85
69084	R69084E	Rejilla proteccion batidora amas. 300 w.	Grillir protection mixeur-pétrisseur 300w	Protective grill blender-kneader 300 w.	46,70
69084	R69084F	Motor batidora-amasadora 5 lts. 300w	Moteur our mixeur pétrisseur 300 w	5 lt. 300w mixer electric engine	26,75
69084	R69084G	Placa control batidora-amasadora 5lt300w	Carte digital pour mixeur pétrisseur 300	5 lt. 300w mixer control card	16,50
69084	R69084H	Control veloc. batidora-amasara 5lt300w	Vitesse poignée mixeur pétrisseur 300w	5 lt. 300w mixer speed control	11,70
69084	R69084J	Interrupt+escob.batid-amasadora 5lt300w	Interrupteur pour mixeur pétrisseur 300w	5 lt. 300w mixer swift+carbon brushes	7,65
69084	R69084K	Correa batidora-amasadora 5 lts.300w	Courrie de transmis.mixeur pétrisseur300	5 lt. 300w mixer engine belt	3,05
69084	R69084i	Piñon planetario (part.41)	Pignon planétaire pour ref.69084	Item 69084 planet small gear	8,95
69084	R69084M	Rueda dentada transferencia	Molette d approche	Transfer gear	8,95
69084	R69084N	Rueda dentada larga	Molette grand	l arge gear	9,95
69084	R69084P	Cinta decorativa	Ruban décoratif	Decorative ribbon	8,95
69084	R69084Q	Eje central para batidora amasador 300w	Axe central pour 69184	Central axis for 69184	13,35
69084	R69095B	Bisagra tapa chafing dish gn 2/3	Charnière bain marie luxe gn 2/3 6 l	Hinge for luxe gn 2/3 chafing dish 6 l	63,20
69084	R69084AA	Engranje motor para 69084	Motor equipement pour 69084	Motor gear for 69084	16,80
69084	R69084AB	Set de engranajes para 69084	Engrenage pour 69084	Gear set for 69084	31,85

Ref.	Repuesto	Descripción	Description	Description	€
69084	R69084AC	Eje para accesorios de 69084	Axe accessoiree pour 69084	Accesoris axis for 69084	27,25
69084	R69084AD	Tapa para caja de engranajes 69084	Couvercle pour boite de vitesses 69084	id for gear box of 69084	57,10
69084	R69084AF	Tapa para ejes amasadora 69084	Haut pour axe 69084	id for axis 69084	116,40
69084	R69084T	Tapa para batidora amasador 69084	Haut pour 69084	id for 69084	5,70
69084	R69084V	Set de engranajes para 69084	Train d engrenages pour 69084	Gear set for 69084	65,95
69084	R69084W	Tapa para batidora amasador 69084 (n)	Haut pour 69084 (n)	id for 69084 (n)	36,65
69084	R69084Z	Set de rodamientos para 69084	Roulements pour 69084	Bearings set for 69084	36,65
69084	R69084AF	Tapa para ejes amasadora 69084	Haut pour axe 69084	id for axis 69084	116,40
69085	R69085A	Vaso batidora electrica de pie 150 w.	Verre pour mixer sur pied 150 w	150w free stand electrical blender cup	25,85
	69094	R69094A Aro compl. chafing dish luxe gn 1/2	Anneau complement chafing-dish luxe 1/2	Gn 1/2 luxe chafing-dish heater holder	15,15
	69094	R69094B Tapa chafing dish luxe gn 1/2	Couvercle bain marie luxe gn 1/2	Luxe gn 1/2 chafing dish lid	310,05
	69094	R69099C Salsera chafing dish luxe	Saucière chafing-dish luxe	Gravy spoon holder	12,70
	69095	R69095A Tapa chafing dish luxe gn 2/3	Couvercle bain marie luxe gn 2/3	Luxe gn 2/3 chafing dish lid	327,35
	69095	R69099B Aro compl. chafing dish luxe gn 1/1-2/3	Anneau complement chafing-dish luxe	Gn 1/1&2/3 luxe chafing-dish heater hold	14,95
	69095	R69099C Salsera chafing dish luxe	Saucière chafing-dish luxe	Gravy spoon holder	12,70
	69096	R69096A Tapa chafing dish luxe redondo 6 lts	Couvercle bain marie luxe ronde 6 lts.	Luxe round chafing dish lid 6 lts	327,35
	69096	R69096B Bisagra tapa chafing dish luxe redondo	Charnière bain marie luxe ronde 6 lts.	Hinge for luxe round chafing dish 6 lts	63,20
	69096	R69096C Cuerpo chafing dish luxe redondo 6 lts	Bac a eau bain marie luxe ronde 6 lts.	Luxe round chafing dish water pan 6 lts	120,80
	69096	R69099C Salsera chafing dish luxe	Saucière chafing-dish luxe	Gravy spoon holder	12,70
	69099	R69099A Tapa chafing dish luxe gn 1/1	Couvercle bain marie luxe gn 1/1	Luxe chafing dish gn 1/1 lid	340,05
	69099	R69099B Aro compl. chafing dish luxe gn 1/1-2/3	Anneau complement chafing-dish luxe	Gn 1/1&2/3 luxe chafing-dish heater hold	14,95
	69099	R69099C Salsera chafing dish luxe	Saucière chafing-dish luxe	Gravy spoon holder	12,70
	69099	R69099D Cubeta agua chafing dish luxe gn 1/1	Réservoir d eau bain marie luxe gn 1/1	Water pan chafing dish gn 1/1 lid	301,90
	69099	R69099E Bisagra tapa chafing dish gn 1/1	Charnière bain marie luxe gn 1/1	Hinge for luxe gn 1/1 chafing dish	60,35
	69099	R69099F Llave desmontaje bisagra chafing dish	Enlever charniere cle chafing dish	Hinge disassembly key for chafing dish	28,00
	69100	R69099C Salsera chafing dish luxe	Saucière chafing-dish luxe	Gravy spoon holder	12,70
	69100	R69100A Conten. chafing dish luxe sopa 11 lts.	Soupiere chafing-dish luxe 11 lts.	Soup container for luxe chafing-dish 11	19,75
	69100	R69100B Aro compl. chafing dish luxe sopa red.	Anneau complement chafing-dish luxe soup	Soup&round luxe chafing-dish heater hold	15,15
	69100	R69100C Tapa chafing dish sopa 11 lts	Couvercle bain marie potage 11 lts.	Luxe soup chafing dish lid	321,65
	69101	R69101A Tapa para chafing dish luxe redondo	Couverture pour ronde chafing dish luxe	Cover for round chafing dish luxe	155,05
	69110	R69110A Tapa chafing dish gn 1/1 inox	Bain marie gn 1/1 couvercle en inox	St steel gn 1/1 chafing-dish lid	13,00
	69110	R69110B Cubeta agua chafing dish gn 1/1 inox	Bac a/gides bain marie gn 1/1 en inox	St steel gn 1/1 chafing-dish water pan	15,25
	69110	R69110C Contenedor gel chafing dish gn 1/1 inox	Porte-bruleur bain marie gn 1/1 en inox	St steel gn 1/1 chafing-dish fuel holder	4,70
	69111	R69111A Interruptor de seguridad batidor 69111	Interrupteur de securite pour 69111	Security switch for beater 69111	4,15
	69111	R69111B Selector de velocidad para batidor 69111	Interrupteur de vitesse pour 69111	Speed switch for beater 69111	7,00
	69111	R69111C Cuchillas para batidor 69111	Batteur lames pour 69111	Mixer blades for beater 69111	7,35
	69111	R69111D Soporte vaso para batidor batidos 69111	Porte gobelet pour batteur 69111	Glass support for beater 69111	4,15
	69111	R69111E Baso inox para batidor batidos 69111	Recipient inoxydable pour 69111	Ss glass for beater 69111	20,25
	69111	R69111F Set 4 pies de goma para 69111	4 pieds en caoutchouc machine 69111	4 rubber feet for 69111	4,70
	69111	R69111G Motor + eje para 69111	Moteur + axe pour 69111	Motor + axis for 69111	95,95
	69115	R69115A Cuchilla rebanadora gruesa para 69115	Épaisseur lame trancheuse pour 69115	Thick slicer blade for 69115	2,05
	69115	R69115B Cuchilla juliana para 69115	Enne lame pour 69115	Julienne blade for 69115	2,05
	69115	R69115C Cuchilla rebanadora fina para 69115	Fine lame trancheuse pour 69115	Thin slicer blade for 69115	2,05
	69115	R69115D Cuchilla rallador grueso para 69115	Lame de râpe grossière pour 69115	Coarse grater blade for 69115	2,05
	69115	R69115E Cuchilla rallador fino para 69115	Lame de râpe fine pour 69115	Fine grater blade for 69115	2,05
	69115	R69115F Tubo t + empujador para 69115	Tube t + poussoir plastique pour 69115	T tube + plastic pusher for 69115	5,80
	69115	R69115G Piezas conectoras motor para 69115	Pièces moteur de conection pour 69115	Motor connection parts for 69115	0,90
	69115	R69115H Conjunto motor para 69115	Ensemble moteur pour 69115	Motor set for 69115	45,50
	69116	R69116K Valvulas entrada/salida de aire 69116	Air prise/sortie soupape pour 69116	Air inlet/outlet valve for 69116	31,55
	69116	R69116I Placa general maquina vacio 69116	Carte principale machine a vide 69116	Main board for vacuum machine 69116	31,15
	69116	R69116M Borna de sellado maquina vacio 69116	Borne d etancheite machine a vide 69116	Sealing terminal vacuum machine 69116	12,20
	69116	R69116N Set 2 juntas piston maquina vacio 69116	Piston joint machine a vide 69116	Piston joint vacuum machine 69116	21,45
	69116	R69116P Micro interruptor maquina vacio 69116	Micro interrupteur machine a vide 69116	Micro switch for vacuum machine 69116	14,75
	69116	R69116Q Piston freno tapa para 69116	Couvercle frein piston pour 69116	id brake piston for 69116	45,80
	69118	R69118A Pantalla protectora coratdora fiam. home	Ecran protecteur trancheuse domes.home	Home food slicer transp.protector	3,25
	69118	R69118B Disco corte cortadora fiambre 119 mm.	Disque trancheuse domestique home	Home food slicer spare blade 190 mm.	22,30
	69118	R69118C Set 4 patas ventosa para cortadora home	Set 4 pieds trancheuse domes.home	4 feet set for home meat slicer	4,90
	69118	R69118D Carro transporte coratdora fiam. home	Chariot pour trancheuse domes.home	Home food slicer tranport tray	12,20
	69118	R69118E Interruptor on/off coratdora fiam. home	Interrupteur on/off trancheuse domes.home	Home food slicer on/off switch	2,05
	69118	R69118F Regulador esponsor coratdora fiam. home	Regulateur d epaisseur trancheuse home	Home food slicer thickness regulator	2,45
	69118	R69118G Engranaje motor para cortadora 69118	Motor reducteur engranage pour 69118	Motor gear for 69118 slicer	5,50
	69119	R69119A Disco corte cortadora fiambre 119 mm.	Disque trancheuse domestique 119 mm	100w food slicer spare blade 190 mm.	8,95
	69119	R69119B Pantalla protec. cortad. fiambre 119 mm.	Ecran protecteur trancheuse domes.119mm	100w food slicer transp.protector	2,75
	69119	R69119C Interruptor cortadora fiambre 119 mm.	Interrupteur trancheuse domes. 119mm	100w food slicer on/off switch	2,25
	69119	R69119D Llave soltar disco cort. fiambre 119 mm.	Cle dever.disque tranch. domes. 119mm	100w food slicer blde key	0,60
	69119	R69119E Engranaje cortadora fiambre 119 mm.	Engrenage trancheuse domes. 119mm	100w food slicer gear	0,90
	69120	R69120A Cono+inserto exprimidor c/brazo	Presse pour presse-fruits electr. 120a/l	Plastic cone+insert elec.orange sque.120	8,95
	69120	R69120B Bandeja filtro exprimidor c/brazo	Filtre pour presse fruits elec.120w a/le	St.steel filter tray elec.orange sque120	11,20
	69120	R69120C Empujador exprimidor c/brazo	Poussoir pour presse fruits a/levier 120	120 w electr.orange squeezer pusher	5,60
	69120	R69120D Contenedor zumo exprimidor c/brazo	Bac pour presse fruits elec.120 a/levier	120 w elec.orange squeezer juice contain	9,95
	69120	R69120E Micro interruptor para 69120	Micro interrupteur pour 69120	Micro swith for 69120	2,35

Ref.	Repuesto	Descripción	Description	Description	€	
69121	R69121A	Bandejas cocedor electrico a vapor 3pcs	3 pcs plateau pour cuiseur vapeur electr	Electric food steamer spare 3 trays	15,65	
69121	R69121B	Tapa cocedor electrico a vapor 1000 w	Couvercle pour cuiseur vapeur electr	Electric food steamer spare lid	4,60	
69121	R69121C	Repuesto cocedor elect.vapor 1000w 3pcs	Rechange pour cuiseur vapeur electr	Electric food steamer spare parts 3 pcs	8,95	
69122	R69122A	Utiles madera para crepera electrica	Spatule+distrib. en bois crêpière electr	Wood tools for electric crepe maker	1,75	
69122	R69122B	Cableado interno para 69122	Cableage interne pour 69122	Internal wiring for 69122	1,75	
69122	R69122C	Interruptor para crepera electrica 1000w	Mise pour 69122	Switch for 69122	0,70	
69123	R69123A	Tapa deshidratador de alimentos 245w	Couvercle deshydrateur des aliments 245w	lid for food dehydrator 245 w	2,75	
69123	R69123B	Compartimiento deshidratador alime 245w	Compartim deshydrateur des aliments 245w	compartment for food dehydrator 245 w	3,15	
69123	R69123C	Base deshidratador de alimentos 245w	Base deshydrateur des aliments 245w	Base for food dehydrator 245 w	46,00	
	69125	R69125A	Disco de corte 250 mm.	Disque de coupes 250 mm.	250 mm. meat slicer blade	151,60
	69125	R69125B	Cable conexion cortadora fiambre 250 mm.	Câble de connexion trancheuse 250 mm.	250 mm. meat slicer cord	5,20
	69125	R69125C	Pomo regul. espesor cortad. 250 mm.	Bouton de réglage épaisseur transc.250 m	250 mm. meat slicer thickness adj.knob	9,95
	69125	R69125D	Pie apoyo cortadora fiambre 250 mm.	Pied appui trancheuse à jambon 250 mm.	250 mm. meat slicer rubber leg	1,10
	69125	R69125E	Pomo sujec. carro cortad.fiambre 250 mm.	Poignée de maintien chariot	250 mm. meat slicer trolley locking knob	2,35
	69125	R69125F	Carro+bandeja cortadora fiambre 250 mm.	Chariot+plateau trancheuse à jambon 250	250 mm. meat slicer trolley & tray	52,80
	69125	R69125G	Mango cortadora fiambre 250 mm.	Manche trancheuse à jambon 250 mm.	250 mm. meat slicer handle	3,05
	69125	R69125H	Rueda desbaste cortadora fiambre 250 mm.	Molette d'approche trancheuse à jambon	250 mm. meat slicer rough sharpen. wheel	10,60
	69125	R69125J	Rueda acabado cortadora fiambre 250 mm.	Molette précision trancheuse à jambon	250 mm. meat slicer fine sharpening whe	10,60
	69125	R69125K	Correa transmis.cort.fiambre 250 mm.	Courroie transmission p/trancheus. 250 m	250 mm. meat slicer transmission belt	17,30
	69125	R69125I	Protector acrilico cort. fiambre 250 mm.	Protecteur acryliq.tranch. jambon 250 mm	250mm cold	5,90
	69125	R69125M	Cabezal afilado cort. fiambre 250 mm.	Bâti supérieur trancheuse à jambon 250 m	250 mm. meat slicer sharpening unit	58,40
	69125	R69125N	Protector disco cort. fiambre 250 mm.	Protecteur de disque trancheuse à jambon	250 mm. meat slicer aluminium cover	65,55
	69125	R69125P	Interruptor cortad. fiambre 250 mm	Interrupteur trancheuse à jambon 250 mm.	250 mm. meat slicer switch	11,20
	69125	R69125Q	Conjunto traccion cort. fiambre 69125	Ensemble traction pour ref.69125	Traction set for meat slicer no.69125	84,15
	69125	R69125R	Conmutador cortadora fiambre 250 mm	Commutateur p/trancheuse à jambon 250 mm	Switchboard f/250 mm ele. cold meat cutt	7,10
	69125	R69125S	Placa de control cortad. fiambre 250 mm	Plaque control p/trancheuse jambon 250mm	Control card f/ele. meat cutter 250 mm	15,85
	69125	R69125T	Pomo trasero sujetad. protect. del disco	Bouton arrière soutien protecteur disque	Backside knob aluminium cover holder	4,15
	69125	R69125U	Interruptor de seguridad	Interrupteur de sécurité	Security switch	5,60
	69125	R69125W	Motor + condensador para 69125-30	Moteur + condens. trancheuse 69125-30	Motor + capacitor for slicer 69125-30	122,30
	69125	R69125AA	(new)protector disco cort fiambre 250 mm	Protecteur de disque trancheuse (new)	250 mm meat slicer aluminium cover (new)	107,55
	69125	R69125AB	Placa de control cortad. fiambre (new)	Plaque control p/trancheuse jambon (new)	Control card f/ele. meat cutter (new)	20,15
	69125	R69125AD	Tapa base negra para 69125	Plafond base pour 69125	Base lid for 69120	9,75
	69125	R69125Z	Conector eje motor para 69125-69130	Connecteur plastique axe 69125-69130	Axis plastico conector for 69125-69130	6,50
	69125	R69125AC	Conjunto traccion (nuevo) 69125	Nouveau ensemble traction pour 69125	New traction set for meat slicer	52,90
	69127	R69127A	Juego 7 boquillas maquina pasta 230w	Machine a pates conseils de jeu 7 230w	Pasta machine tips game 7 230w	4,60
	69127	R69127B	Tuerca + llave maquina de pasta 230w	Ecrou et key machine a pates 230w	Nut + pasta machine key 230w	1,30
	69127	R69127C	2 vasos mezcladores + tubo salida	2 mixer de verre + sortie tube	Measuring cups + extension	1,10
	69127	R69127D	Tapa superior maquina de pasta 230w	Haute baie	Upper cover	7,55
	69127	R69127E	Eje helice maquina de pasta 230w	Arbre de transmission	Motor helix	3,35
	69127	R69127F	Helice grande para maquina pasta 230w	Helice de grand diametre	Pasta turner mixer	2,15
	69127	R69127G	Contenedor de pasta maquina de pasta 230w	Conteneur de pâtes alimentaires	Pasta container	9,55
	69127	R69127H	Motor maquina de pasta 230w	Moteur pour 69127	Motor for 69127	32,35
	69127	R69127J	Interruptor maquina de pasta 230w 3pcs	Interrupteur + cord pour 69127 - 3 pcs	Switch set + wire for 69127 - 3 pcs	2,35
	69127	R69127K	Placa control maquina de pasta 230w	Pcb pour 69127	Pasta machine pcb	5,20
	69129	R69129A	Cestillo freidora multifuncion c/mango	Panier friteuse multifonction avec poign	Multif.elec.cooker frying basket w/handl	5,10
	69129	R69129B	Contenedor 5 lts freidora multifuncion	Conteneur 5l friteuse multifonction	Multifunction electr cooker container5l	38,05
	69129	R69129C	Tapa cristal freidora multifuncion	Dessus en verre friteuse multifonction	Multifunction electric cooker glass lid	12,40
	69129	R69129F	Rejilla alta freidora multifuncion	Multifonction friteuse haute grille	Multifunction electric cooker steam rack	2,25
	69129	R69129G	Rejilla baja freidora multifuncion	Grille du bas multifonction friteuse	Multifunction electric cooker low rack	2,15
	69129	R69129H	6 pcs tenedor fondue freidora multifunc.	6 pcs fondue de fourche	Multifunc.electr.cooker 6pc fondue forks	3,15
	69129	R69129J	Mango freidora multifuncion 1500w	Mangue friteuse multifonction 1500w	Multifunc.electr.cooker spare handle	1,75
	69129	R69129K	Termostato+reloj freidora multifuncion	Thermostat + horloge multifuc friteuse	Multifunc.electr.cooker thermostat+timer	12,10
	69130	R69125B	Cable conexion cortadora fiambre 250 mm.	Câble de connexion trancheuse 250 mm.	250 mm. meat slicer cord	5,20
	69130	R69130A	Disco cortadora fiambre 300 mm	Disque de coupes 300 mm	300 mm meat slicer blade	219,70
	69130	R69130C	Pomo regulacion espesor cortadora 300 mm	Bouton de réglage épaisseur transc.300mm	300mm meat slicer thickness adjust.knob	13,45
	69130	R69130D	Pie apoyo cortadora fiambre 300 mm	Pied appui trancheuse à jambon 300 mm	250 mm meat slicer rubber leg	1,40
	69130	R69130E	Pomo sujecci.carro cortad.fiambre 300 mm	Poignée de maintien chariot 300 mm	300 mm meat slicer trolley locking knob	2,65
	69130	R69130F	Carro+bandeja cortadora fiambre 300 mm	Chariot+plateau trancheuse à jambon 300m	300 mm meat slicer trolley & tray	87,30
	69130	R69130H	Rueda desbaste cortadora fiambre 300 mm	Roue à dégrossir pour 69130	300mm meat slicer coarse sharpenn.wheel	20,55
	69130	R69130J	Rueda acabado cortadora fiambre 300 mm	Molette précision trancheuse à jambon300	300mm meat slicer fine sharpening wheel	13,45
	69130	R69130K	Correa transmis.cortad.fiambre 300 mm	Courroie transmission p/trancheus.300mm	300 mm meat slicer transmission belt	26,95
	69130	R69130I	Protector acrilico cortad.fiambre 300mm	Protecteur acryliq.tranch. jambon 300 mm	300 mm meat slicer acrylic protection	7,20
	69130	R69130M	Cabezal afilado cortadora fiambre 300 mm	Bâti supérieur trancheuse à jambon 300mm	300mm meat slicer sharpening unit	82,50
	69130	R69130N	Protector disco cortadora fiambre 300 mm	Protecteur disque trancheuse à jambon300	300 mm meat slicer aluminium cover	23,40
	69130	R69130P	Interruptor de encendido	Interrupteur de puissance	Power switch	11,70
	69130	R69130Q	Conjunto traccion cortad.fiambre 300 mm	Ensemble traction pour ref.69130	Traction set for 300 mm meat slicer	109,90
	69130	R69130T	Pomo trasero sujetad. protect.disco 300m	Bouton arrière soutien protect.disque300	Backside knob aluminium cover holder300m	8,45
	69130	R69130U	Interruptor seguridad cortadora 300 mm	Interrupteur de sécurité 300 mm	300 mm meat slicersecurity switch	7,35
	69130	R69130R	Nuevo interruptor seguridad cortadora	Neuf interrupteur de sécurité	New meat slicersecurity switch	7,10
	69130	R69130S	Motor para 69130	Moteur pour 69130	Motor for slicer 69130	191,90
	69130	R69130W	Tapa base negra para 69130	Plafond base pour 69130	Base lid for 69130	12,20
	69130	R69130Z	Protector disco cortadora 69130 vieja	Protecteur disque trancheuse 69130 vieux	O: D 300 mm MEAT SLICER ALUMINIUM COVER	20,95
	69130	R69130AA	Soporte bloque afilador 69130	Support d aiguiser de lame 69130	Blade shrapener support 69130	18,70
	69131	R69131A	Regulador para calentador 69131	Regulateur d temperature pour 69131	Temperature regulator for 69131	31,55
	69131	R69131B	Placa de control electronica 69131	Carte electronique para 69131	Electronic main board for 69131	22,90



Ref.	Repuesto	Descripción	Description	Description	€	
	69132	R69132A	Cable conexion placa induccion 3500w	Câble connexion p/plaque induction 3500w	3500 w induction plate plug cord	5,60
	69132	R69132B	Etiqueta frontal placa induccion 3500w	Étiquette frontale p/plaque induct. 3500w	3500 w induction plate front sticker	2,25
	69132	R69132C	Bobina cobre placa induccion 3500w	Bobine de cuivre p/plaque induction 3500	3500 w induction plate heating coil	17,80
	69132	R69132D	Panel de control placa induccion 3500 w	Tableau contrôle p/plaque induction 3500	3500 w induction plate control panel	6,70
	69132	R69132E	Tarjeta dig. control placa induc. 3500w	Carte digital p/plaque induction 3500w	3500 w induction plate main board	50,05
	69132	R69132F	Ventilad. (4unid.) placa induccion 3500w	Ventil. p/plaque induction 3500w (5 pie)	3500 w induction plate fan (4 units)	20,05
	69132	R69132G	Pies (4 unid.) placa induccion 3500w	Pie pour induction plaque 3500w (4units)	3500 w induction plate feet (4 units)	2,25
	69132	R69132H	Placa cristal induccion 3500w	Plaque de verre pour 69132	Induction glass plate for 69132	65,45
	69132	R69132J	Sensor de temperatura 100k para 69132	Capteur de temperature 100k pour 69132	100k temperature sensor for 69132	16,70
	69132	R69132K	Placa de control v13 para 69132	V13 panneau de commande pour 69132	V13 control panel for 9132	59,95
	69132	R69132L	Sensor temperatura v13 100k para 69132	Capteur de temperature 100k 69132 v13	100k temperature sensor for 69132 v13	2,85
						0,00
						0,00
	69133	R69133A	Repuesto cristal placa grill 27x43 cm	Pièce verre détachée plaque grill 27x46cm	Cooking grill plate 27x43 cm spare glass	83,45
	69133	R69133B	Proteccion repuesto placa grill 27x43cm	Protecteur du plaque grill 27x43 cm	Grill plate 27x43 cm protection spare	9,45
	69133	R69133C	Repuesto placa grill 2 espátulas	2 spatule pour plaque grill 69133	Cooking grill plate spare 2 espátulas	9,45
	69133	R69133D	Repuesto placa grill placa control	Plaque du control p/plaque grill 69133	Cooking grill plate pcb key board proce.	10,60
	69133	R69133E	Repuesto placa grill placa cont.potencia	Plaque contr. puissance plaq.grill 69133	Cooking grill plate pcb power board	44,45
	69133	R69133F	Repuesto placa grill 2 asas costado	2 poignée pour plaque grill 69133	Cooking grill plate spare 2 side handles	4,50
	69133	R69133G	Repuesto placa grill micro interruptor	Micro interrupteur p/plaque grill 69133	Cooking grill plate microswitch 5pcs set	5,00
	69133	R69133J	Repuesto placa grill 4 pies goma	4 pied en caoutchouc plaque grill 69133	Cooking grill plate 4 rubber feet set	1,40
	69133	R69133K	Repuesto placa grill 5 pcs acces.varios	5 pièces détachées p/plaque grill 69133	Cooking grill plate 5 pcs assorted spare	1,40
	69133	R69133L	Repuesto placa grill etiqueta mando	Étiquette télécommand plaque grill 69133	Cooking grill plate nameplate sticker	1,55
	69133	R69133P	Repuesto placa vitroceramica 69133	Puissance plaque 69133	Cooking grill plate for 69133	85,05
	69134	R69134C	Tapa freidora 4 lts.	Couvercle pour friteuse 4 lts.	lid for 4 lts. electric deep fryer	7,85
	69134	R69134F	Conj.calen.freidora electrica 4 lts.	Ensemb. chauffant p/ friteuse elec. 4 l	Set of elec. heat. unit f/ elec. fryer	38,85
	69134	R69134G	Grifo freidora electrica 4 lts.	Robinet pour friteuse electricue 4 lts.	Fauce for 4 lts. electric deep fryer	35,10
	69134	R69135A	Cestillo freidora elec. 3.5 - 7 - 4 lts.	Panier p/friteuse élect. 3.5 - 7- 4 lts.	3.5 -7- 4lts. electric deep fryer basket	9,95
	69134	R69135H	Set 4 pies freidora elec. 3,5 y 7 lts.	Set 4 pieds pour friteuse elect. 3,5 y 7	Set 4 rubber foots electric deep fryer 3	1,65
	69135	R69135A	Cestillo freidora elec. 3.5 - 7 - 4 lts.	Panier p/friteuse élect. 3.5 - 7- 4 lts.	3.5 -7- 4lts. electric deep fryer basket	9,95
	69135	R69135B	Cubeta freidora electrica 3.5 lts.	Huile bac p/friteuse élect. 3.5 -7 lts	3.5 -7 lts. electric deep fryer contain.	32,15
	69135	R69135C	Tapa freidora electrica 3.5 lts.	Couvercle p/friteuse électrique 3.5 -7 l	3.5 - 7 lts. electric deep fryer lid	11,20
	69135	R69135D	Pomo freidora electrica 3.5 lts.	Bouton p/friteuse électrique 3.5 -7 lts.	3.5 - 7 lts. electric deep fryer knob	1,10
	69135	R69135E	Asa costado freidora electrica 3.5 lts.	Anse pour friteuse électri. 3.5 - 7 lts.	3.5-7 lts. elec. deep fryer side handle	1,10
	69135	R69135G	Filtro tapa freidora elec. 3,5 y 7 lts.	Filtre pour friteuse electricue 3,5 y 7	Filter for electric deep fryer 3,5 y 7 l	0,45
	69135	R69135H	Set 4 pies freidora elec. 3,5 y 7 lts.	Set 4 pieds pour friteuse elect. 3,5 y 7	Set 4 rubber foots electric deep fryer 3	1,65
	69135	R69135T	Conj.calentad.freid.elec. new	Ensemb.chauffant p/friteuse new	2000w deep fryer heating unit new	41,40
	69137	R69137A	Cuchillo + 3 art para maquina de pasta	Curseur + pièce jointe 3 pour 69137	Slider + 3 attachment for 69137	3,85
	69137	R69137B	Espiral para maquina de pasta	Convoyeur bobine pour 69137	Dough transport coil for 69137	4,70
	69137	R69137C	Juego de boquillas para 69137	10 disques pour 69137	10 discs for 69137	7,00
	69137	R69137D	Tuerca aluminio para 69137	Noix aluminium pour 69137	Sealing washer for 69137	6,70
	69137	R69137E	Tapa para 69137	Haut pour 69137	Transparent cover for 69137	6,20
	69137	R69137F	Batidor con eje para 69137	Bol avec arbre pour 69137	Mixing paddle + axis for 69137	4,70
	69137	R69137G	Cubeta pasta para 69137	Melange contenant + panneau avant 69137	Mixing container + front panel for 69137	17,80
	69137	R69137H	Switch on off	Interrupteur on off 69137	Switch on off for 69137	1,10
	69137	R69137J	Motor para 69137	Moteur pour 69137	Motor for 69137	44,45
	69137	R69137K	Engranajes para 69137	Vitesses pour 69137	Gears for 69137	11,70
	69137	R69137L	Cpu + junta trinominal para 69137	Cpu + conseil trinominal pour 69137	Cpu + trinominal board for 69137	9,95
	69137	R69137M	Cable de encendido + fixup para 69137	On + fixup fil pour 69137	On + fixup wire para 69137	6,70
	69137	R69137N	Set 2 patas para 69137	Set 2 pieds de silicone pour 69137	2 rubber feet set for 69137	4,80
	69138	R69138A	Placa ceramica para 69138	Plaque ceramique pour 69138	Ceramic plate forc 69138	46,70
	69138	R69138B	Placa de control de cristal	Verre plaque de commande	Control glassplate	8,15
	69138	R69138C	Bobina de calentamiento	Bobine de chauffage	Heating coil	33,35
	69138	R69138D	Placa de control	Panneau de commande	Control panel	14,75
	69138	R69138E	Placa base	Carte principale	Mainboard	73,35
	69138	R69138F	Placa ceramica para 69138-d.295 mm	Plaque ceramique pour 69138-d.295 mm	Ceramic plate forc 69138-d.295 mm	44,45
	69139	R69139A	Regulador para calentador 69139	Regulateur d temperature pour 69139	Temperature regulator for 69139	31,55
	69139	R69139B	Placa de control electronica 69139	Carte electronique para 69139	Electronic main board for 69139	22,90
	69143	R69143A	Conj.cuchilla+palanca abrelatas electric	Ensemble lames + levier ouvre-boîte elec	Electric can openner blade+lever set	7,75
	69145	R69145A	Juego 4 pies de goma + tornillo	lot des 4 caoutchouc pieds + vis	Set of 4 rubber feet + screw	4,15
	69145	R69145B	Fusible termico para 69145	Fusible thermique 69145	Thermal fuse for 69145	9,05
	69145	R69145C	Regulador de temperatura placa 69145	Regulateur temp. plaque de réchauffement	Temperatura regulator for warming plate	6,30
	69151	R69050A	Cinta teflon maquina vacio hogar	Bande teflon pour machine souds visde	Teflon string for home vacuum pack	2,65
	69151	R69050B	Hilo resistencia máquina vacio hogar	Resistance scellage pour machine souds v	Resistance for home vacuum pack	0,60
	69151	R69050C	Almohadilla vacio superior vacio hogar	Coussin vide superieur pour machine	Upper foam for home vacuum pack	2,75
	69151	R69050D	Almohadilla vacio inferior vacio hogar	Coussin vide inferieur pour machine	Bottom foam for home vacuum pack	2,25
	69151	R69050E	Goma sellado maquina vacio hogar	Caoutchouc scellage pour machine	Rubber tube for home vacuum pack	2,15
	69151	R69050F	Adaptador maquina vacio hogar	Adaptateur pour recipients pour machine	Home vacuum pack adapter	3,35
	69151	R69050G	Tapa recipiente maq. vacio hogar	Couvercle recipient pour machine souds	lid for home vacuum pack canister	5,60
	69151	R69050H	2 pulsador later+4pies goma+41 tornillos	2 bouton+4 pie a caoutchouc+41 vis	2 side buttoms+4rubber feet+41 screws	3,35
	69151	R69050K	Bomba succion maquina vacio domestica	Pompe de succion pour machine souds visd	Household vacuum machine suction pump	12,30



Ref.	Repuesto	Descripción	Description	Description	€
69151	R69151B	Hilo resistencia maquina vacio luxe	Resistance scellage pour machine souds v	Resistance for luxe vacuum pack	2,55
69151	R69151C	Almohadilla vacio superior vacio luxe	Coussin vide superieur pour machine	Upper foam for luxe vacuum pack	2,45
69151	R69151D	Almohadilla vacio inferior vacio luxe	Coussin vide inferieur pour machine	Bottom foam for luxe vacuum pack	1,85
69151	R69151E	Goma sellado maquina vacio luxe	Caoutchouc scellage pour machine	Rubber tube for luxe vacuum pack	1,40
69151	R69151F	Placa control maquina vacio 69151	Panneau commande souds visde 69151	Pcboard for 69151 vacuum machine	47,10
69151	R69151G	2 pulsadores laterales para 69151	Boutons ouvrir et fermer souds pour 69151	Open/close buttons for 69151	5,30
69151	R69151N	Tube neumatico para maquina vacio luxe	Tube pneumatique pour 69151	Pneumatic tube for 69151	0,80
69159	R69159B	Empujador cortadora fiambre d.170mm 160w	Ecran protecteur trancheuse domes.160 w	160w food slicer transp. protector	3,35
69159	R69159C	Mando control cortad.fiambre 170mm 160w	Interrupteur trancheuse domestique 160w	160w food slicer on/off switch set	40,10
69159	R69159D	Carro cortadora fiambre d.170mm 160w	Chariot pour trancheuse electrique 160w	160w food slicer carriage	5,60
69159	R69159E	Engranaje cortadora fiambre d.170mm 160w	Engrenage trancheuse domestique 160w	160w food slicer planetary gear	1,10
69159	R69159F	Ventosa cortadora fiambre 160w 4 pcs	Ventouse trancheuse domestique 160w 4pcs	160w food slicer suction pad 4 pcs	1,10
69159	R69159G	Bandeja fija para 69159	Plateau fixe pour 69159	Fixed tray for 69159	28,10
69161	R69161A	Recetario thermochef club natura francia	iivre recette francais thermochef natura	Thermochef clubnatura french recipe book	81,40
69161	R69161C	Tapa jarra thermochef	Couvercle bol thermochef	Thermochef jug lid	10,20
69161	R69161D	Paleta mezcladora thermochef	Mélangeur thermochef	Thermochef mixing trowel	2,55
69161	R69161E	Espatula completa thermochef	Statule complète	Thermochef complete spatula	5,10
69161	R69161F	Cuchillas thermochef	iames thermochef	Thermochef blades	48,85
69161	R69161G	Vaso medidor thermochef	Thermochef verre doseur measuring cup	Thermochef measuring cup	3,05
69161	R69161H	Bandeja vaporera plastico thermochef	Plateau acc. vapeur	Plastic tray for thermochef steamer	8,15
69161	R69161J	Tapa bandeja vaporera thermochef	Couvercle acces. vapeur	i id for thermochef steamer	14,25
69161	R69161K	Bandeja vaporera metal thermochef	Accessoire vapeur steamer	Inox tray for thermochef steamer	91,60
69161	R69161L	Anillo fijacion cuchillas thermochef	Joint du fixation du lamé thermochef	Thermochef jug blades locking base	6,10
69161	R69161N	Cesta thermochef	Thermochef panier	Thermochef basket	37,65
69161	R69161P	Cable thermochef	Câble de fiche	Thermochef cirdset	16,70
69161	R69161Q	Recetario thermochef club natura españa	iivre recette espagne thermochef natura	Thermochef club natura spain recipe book	81,40
69161	R69161R	Recetario+manual thermochef natur ingles	iivre recette angle thermochef natura	Thermochef english manual+recipe book	16,70
69161	R69161S	Plato de bascula	Plat dechelle	Dish of scale	57,10
69161	R69161T	Asa de la jarra thermochef club natura	Decanter manche pour 69161	Handle of pitcher for 69161	8,25
69161	R69161U	Cableado thermochef	Câblage thermochef	Wiring for thermochef	15,35
69161	R69161V	Conexion cuchilla thermochef	Connexion de la lame thermochef	Blade connectionfor thermochef	5,60
69161	R69161W	Engranaje conjunto motor 69161	Motórducteur mixte pour 69161	Joint gear motor for 69161	28,20
69161	R69161X	Carcasa thermochef club natura	iogement pour 69161	Housing for 69161	40,00
69161	R69161Y	Correa motor 69161	Courroie moteur pour 69161	Belt engine for 69161	19,65
69161	R69161Z	Conexion cuchilla 69161	Connexion de la lame pour 69161	Blade conexon for 69161	3,95
69161	R69161AB	Anillo fijador cuchillas	Anneau de la lame pour 69161	Ring for cutter 69161	1,00
69161	R69161AC	Tapa nueva jarra thermochef	Nouveau couvercle bol thermochef	Thermochef jug new lid	10,90
69161	R69161AD	Jarra nueva thermochef s/tapa s/cuchilla	Nouvea thermochef bol s/couvercle&lames	Thermochef new jug wo/lid&blades	128,60
69161E	R69161A	Recetario thermochef club natura francia	iivre recette francais thermochef natura	Thermochef clubnatura french recipe book	81,40
69161E	R69161C	Tapa jarra thermochef	Couvercle bol thermochef	Thermochef jug lid	10,20
69161E	R69161D	Paleta mezcladora thermochef	Mélangeur thermochef	Thermochef mixing trowel	2,55
69161E	R69161E	Espatula completa thermochef	Statule complète	Thermochef complete spatula	5,10
69161E	R69161F	Cuchillas thermochef	iames thermochef	Thermochef blades	48,85
69161E	R69161G	Vaso medidor thermochef	Thermochef verre doseur measuring cup	Thermochef measuring cup	3,05
69161E	R69161H	Bandeja vaporera plastico thermochef	Plateau acc. vapeur	Plastic tray for thermochef steamer	8,15
69161E	R69161J	Tapa bandeja vaporera thermochef	Couvercle acces. vapeur	i id for thermochef steamer	14,25
69161E	R69161K	Bandeja vaporera metal thermochef	Accessoire vapeur steamer	Inox tray for thermochef steamer	91,60
69161E	R69161L	Anillo fijacion cuchillas thermochef	Joint du fixation du lamé thermochef	Thermochef jug blades locking base	6,10
69161E	R69161N	Cesta thermochef	Thermochef panier	Thermochef basket	37,65
69161E	R69161P	Cable thermochef	Câble de fiche	Thermochef cirdset	16,70
69161E	R69161Q	Recetario thermochef club natura españa	iivre recette espagne thermochef natura	Thermochef club natura spain recipe book	81,40
69161E	R69161AB	Anillo fijador cuchillas	Anneau de la lame pour 69161	Ring for cutter 69161	1,00
69161E	R69161AC	Tapa nueva jarra thermochef	Nouveau couvercle bol thermochef	Thermochef jug new lid	10,90
69161E	R69161AD	Jarra nueva thermochef s/tapa s/cuchilla	Nouvea thermochef bol s/couvercle&lames	Thermochef new jug wo/lid&blades	128,60
69162	R69162A	Bandeja recogemigas 8x16 cms.	Plateau ramasse-miettes pour 69162	Electrical toaster crumbs tray	2,25
					0,00
					0,00
	69163	Resistencias calentadoras cuarzo 69163	iampe chauffage for 69163	Quartz heating lamps for 69163	6,80
	69163	Bandeja recogemigas tostadora 69163	Plateau ramasse-miettes pour 69163	Crumbs try for 69163	4,15
	69163	Mando temporizador para 69163	Commande temporisateur pour 69163	Timer controler for 69163	4,90
	69164	Bandeja recogemigas 8x16 cms.	Plateau ramasse-miettes pour 69162	Electrical toaster crumbs tray	2,25
	69166	Resistencia inferior. grill 2,2-4,4 kw.	Resistor inferieure p/grill 2.2-4.4 k	Inferior resistance for grill 2.2-4.4	38,05
	69166	Termostato grill electrico 2.2-4.4 kw	Thermostat pour electrique grill 2.2-4.4	Thermostat for electric grill 2.2-4.4 kw	48,05
	69166	Mando termostato grill 2.2-4.4 kw.	Thermostat commande pour grill 2.2-4.4 k	Thermostat controñ for grill 2.2-4.4 kw.	3,55
	69166	i uz power grill electrico 2.2-4.4 kw	i umiere power electriq. grill 2.2-4.4 kw	Power light f/electric grill 2.2-4.4 kw.	8,95
	69166	2 pies de coma grill elec. 2,2-4,4 kw.	2 pied en caoutchouc pour grill 2.2-4.4	2 rubber feet set for grill 2.2-4.4 kw.	4,90
	69166	Cable conexion grill elec. 2,2 kw.	Câble branchement pour grill 2,2 kw	Power cord for electric grill 2,2 kw	14,45
	69166	Empuñadura grill electrico 2,2-4,4 kw.	Poignée pour electrique grill 2,2-4,4 kw	Handle for electric grill 2,2-4,4 kw.	4,90
	69166	Bandeja recogegrasas grill 2,2 kw.	Graisse plateau pour grill 2.2 kw.	Fat tray for grill 2.2 kw.	8,05
	69166	Resistencia superior grill 2,2-4,4 kw.	Resistor superieure p/grill 2.2-4.4 k	Upper resistance for grill 2.2-4.4	36,75
	69166	i uz hot grill electrico 2.2- 4.4 kw	i umiere hot electriq. grill 2.2-4.4 kw	Hot light f/electric grill 2.2- 4.4 kw.	8,55
	69166	Muelle para grill electrico 2.2- 4.4 kw	Primtems hot electriq. grill 2.2-4.4 kw	spring for electric grill 2.2- 4.4 kw.	3,35
	69166	Mando temporizador	Commande temporisateur	Timer switch	12,70
					0,00
					0,00
	69167	Resistencia inferior. grill 2,2-4,4 kw.	Resistor inferieure p/grill 2.2-4.4 k	Inferior resistance for grill 2.2-4.4	38,05
	69167	Termostato grill electrico 2.2-4.4 kw	Thermostat pour electrique grill 2.2-4.4	Thermostat for electric grill 2.2-4.4 kw	48,05





Ref.	Repuesto	Descripción	Description	Description	€
69167	R69166C	Mando termostato grill 2,2-4,4 kw.	Thermostat commande pour grill 2.2-4.4 k	Thermostat control for grill 2.2-4.4 kw.	3,55
69167	R69166D	uz power grill electrico 2.2-4.4 kw	umiere power electriq. grill 2.2-4.4 kw	Power light f/electric grill 2.2-4.4 kw.	8,95
69167	R69166E	2 pies de coma grill elec. 2,2-4,4 kw.	2 pied en caoutchouc pour grill 2.2-4.4	2 rubber feet set for grill 2.2-4.4 kw.	4,90
69167	R69166G	Empuñadura grill electrico 2,2-4,4 kw.	Poignée pour électrique grill 2,2-4,4 kw	Handle for electric grill 2,2-4,4 kw.	4,90
69167	R69166J	Resistencia superior grill 2,2-4,4 kw.	Resistor superieure p/grill 2.2-4.4 k	Upper resistance for grill 2.2-4.4	36,75
69167	R69166K	uz hot grill electrico 2.2- 4.4 kw	umiere hot electriq. grill 2.2-4.4 kw	Hot light f/electric grill 2.2- 4.4 kw.	8,55
69167	R69166I	Muelle para grill electrico 2.2- 4.4 kw	Primtems hot electriq. grill 2.2-4.4 kw	spring for electric grill 2.2- 4.4 kw.	3,35
69167	R69166M	Mando temporizador	Commande temporisateur	Timer switch	12,70
69167	R69167F	Cable conexion grill elec. 4,4 kw.	Câble branchement pour grill 4.4 kw	Power cord for electric grill 4.4 kw	13,95
69167	R69167H	Bandeja recoge grasas grill 4,4 kw.	Graisse plateau pour grill 4,4 kw	Fat tray for grill 4,4 kw	9,95
69169	R69169A	Tapa freidora electrica 6 lts 2500w	Haut pour friteuse electricque 6 lt 2500w	lid for electric fryer 6 lts 2500w	18,30
69169	R69169B	Cestillo para freidora electrica 6 lts	Panier friteuse electricque 6 lt 2500w	Frying basket for electric fryer 6 lts	22,70
69169	R69169C	Conj. calentador freidora electrica 6 l	Esem. chauffant friteuse electricque 6 lt	Heating set for electric fryer 6 lts	174,40
69169	R69169D	Cestillo de pie freidora elec. 6 l 2500w	Faible panier friteuse electricque 6 lt	ow basket for electric fryer 6 lts	10,50
69169	R69169E	Cubeta freidora electrica 6 lts 2500w	Huile bac pour friteuse electricque 6 lt	Oil container electric fryer 6 lts	33,60
69170	R69135A	Cestillo freidora elec. 3.5 - 7 - 4 lts.	Panier p/friteuse élect. 3.5 - 7- 4 lts.	3.5 -7- 4lts. electric deep fryer basket	9,95
69170	R69135B	Cubeta freidora electrica 3.5 lts.	Huile bac p/friteuse élect. 3.5 -7 lts	3.5 -7 lts. electric deep fryer contain.	32,15
69170	R69135C	Tapa freidora electrica 3.5 lts.	Couvercle p/friteuse électrique 3.5 -7 l	3.5 - 7 lts. electric deep fryer lid	11,20
69170	R69135D	Pomo freidora electrica 3.5 lts.	Bouton p/friteuse électrique 3.5 -7 lts.	3.5 - 7 lts. electric deep fryer knob	1,10
69170	R69135E	Asa costado freidora electrica 3.5 lts.	Anse pour friteuse électri. 3.5 - 7 lts.	3.5-7 lts. elec. deep fryer side handle	1,10
69170	R69135G	Filtro tapa freidora elec. 3,5 y 7 lts.	Filtere pour friteuse electricque 3,5 y 7 l	Filter for electric deep fryer 3,5 y 7 l	0,45
69170	R69135H	Set 4 pies freidora elec. 3,5 y 7 lts.	Set 4 pieds pour friteuse elect. 3,5 y 7	Set 4 rubber foots electric deep fryer 3	1,65
69171	R69171A	Tapa trasera de enfriador blackline	Couverture arrière refroidisseur blackli	Blackline cooler back cover	13,45
69171	R69171B	Bloque enfr.arm. refr.black line 18 bot.	Bloc refr. p/refroid. 8 bout.black line	Cooling system f/18 bott. wine cellar bl	66,75
69171	R69171S	Puerta arm.ref. black line 18 botellas	Porte vit. p/refroid. à vin 18 bout.bl	Glass door f/ 16 bot. wine cel.bl	64,50
69172	R69172A	Parrilla grill electrico horizontal	Grill électrique horizontal	Electric horizontal grill rack	9,95
69172	R69172B	Bandeja recogedora grill elec.horiz.	Plateau récupérateur grill élec.hor.	Electric horizontal grill drip tray	18,70
69172	R69172C	Mango grill electrico horizontal	Manche grill électrique horizontal	Electric horizontal grill handle	4,50
69172	R69172D	Interruptor potencia grill elec. horiz.	Interrupteur puissance grill élec. hor.	Electric horizontal grill power switch	2,25
69172	R69172E	Mando temporizador grill elec. hor.	Commande temporisateur grill élec.hori	Electric horizontal grill timer control	5,60
69172	R69172F	ampara calentamiento grill elec. hor.	ampe chauffage grill électrique hor.	Electric horizontal grill heating lamp	35,00
69172	R69172G	Interruptor potencia grill elec. horiz.	Interrupteur puissance grill élec. hor.	Electric horizontal grill power switch	7,00
69172	R69172H	Mando temporizador grill elec. hor.	Commande temporisateur grill élec.hori	Electric horizontal grill power switch	5,50
69172	R69172K	ampara calentamiento grill elec. nuevo	New lampe chauffage grill électrique hor	New electric horiz.l grill heating lamp	61,05
69173	R69172A	Parrilla grill electrico horizontal	Grill électrique horizontal	Electric horizontal grill rack	9,95
69173	R69172B	Bandeja recogedora grill elec.horiz.	Plateau récupérateur grill élec.hor.	Electric horizontal grill drip tray	18,70
69173	R69172C	Mango grill electrico horizontal	Manche grill électrique horizontal	Electric horizontal grill handle	4,50
69173	R69172D	Interruptor potencia grill elec. horiz.	Interrupteur puissance grill élec. hor.	Electric horizontal grill power switch	2,25
69173	R69172E	Mando temporizador grill elec. hor.	Commande temporisateur grill élec.hori	Electric horizontal grill timer control	5,60
69173	R69172F	ampara calentamiento grill elec. hor.	ampe chauffage grill électrique hor.	Electric horizontal grill heating lamp	35,00
69173	R69173D	Interruptor superior grill elec. hor.	Interrupteur supérieur grill élec.hor.	Electric horizontal grill up switch	4,40
69173	R69172G	Interruptor potencia grill elec. horiz.	Interrupteur puissance grill élec. hor.	Electric horizontal grill power switch	7,00
69173	R69172H	Mando temporizador grill elec. hor.	Commande temporisateur grill élec.hori	Electric horizontal grill power switch	5,50
69173	R69172K	ampara calentamiento grill elec. nuevo	New lampe chauffage grill électrique hor	New electric horiz.t grill heating lamp	61,05
69174	R69174A	Placa inferior plancha grill 1400w 30x26	Plaque inférieure grill de contact 1400w	Contact grill 1400w 30x26cm bottom grill	31,15
69174	R69174B	Placa superior salamandra-grill 1400w	Plaque supérieure grill de contact 1400w	Contact grill 1400w 30x26 cm upper grill	32,75
69174	R69174C	Temporizador salamandra-grill 1400w	Minuterie p/grill de contact 1400w 30x26	Contact grill 1400w 30x26 cm spare timer	4,80
69174	R69174D	Termostato salamandra-grill 1400w	Thermostat p/grill de contact 1400w	Contact grill 1400w spare thermostat	4,05
69174	R69174E	Cubeta grasas salamandra-grill 1400w	Bac à graisse p/grill de contact 1400w	Contact grill 1400w spare fat container	1,40
69174	R69174F	Cable potencia salamandra-grill 1400w	Câble puissance p/grill de contact 1400w	Contact grill 1400w spare power cord	5,00
69174	R69174G	Resistencia salamandra-grill 1400w	Resistor p/grill de contact 1400w	Contact grill 1400w spare resistance	6,10
69174	R69174H	Cable resistencia salamandra-grill 1400w	Câble element chauffaant grill 69174	Contact grill 1400w heatin element cord	5,70
69175	R69175A	Parte int.botonera de 69175	Int.partier de l'armoire 69175	Int. part of the panel for 69175	5,00
69175	R69175B	Bloque enfriador para armario 69175	Bloc refroidisseur pour 69175	Cooling system for 69175	73,35
69175	R69175C	Filtro para armario refrigerado 69175	Filtere pour 69175	Filter for wine cellar 69175	2,15
69175	R69175S	Puerta armario refr.black line 28 bot.	Porte p/refroid.black line 28 bout.	Door for 28 bott. wine cellar black line	69,00
69176	R69166A	Resistencia inferior. grill 2,2-4,4 kw.	Resistor inferieure p/grill 2.2-4.4 k	Inferior resistance for grill 2.2-4.4	38,05
69176	R69166B	Termostato grill electrico 2.2-4.4 kw	Thermostat pour électrique grill 2.2-4.4	Thermostat for electric grill 2.2-4.4 kw	48,05
69176	R69166C	Mando termostato grill 2,2-4,4 kw.	Thermostat commande pour grill 2.2-4.4 k	Thermostat control for grill 2.2-4.4 kw.	3,55
69176	R69166D	uz power grill electrico 2.2-4.4 kw	umiere power electriq. grill 2.2-4.4 kw	Power light f/electric grill 2.2-4.4 kw.	8,95
69176	R69166E	2 pies de coma grill elec. 2,2-4,4 kw.	2 pied en caoutchouc pour grill 2.2-4.4	2 rubber feet set for grill 2.2-4.4 kw.	4,90
69176	R69166F	Cable conexion grill elec. 2,2 kw.	Câble branchement pour grill 2,2 kw	Power cord for electric grill 2,2 kw	14,45
69176	R69166G	Empuñadura grill electrico 2,2-4,4 kw.	Poignée pour électrique grill 2,2-4,4 kw	Handle for electric grill 2,2-4,4 kw.	4,90
69176	R69166H	Bandeja recoge grasas grill 2,2 kw.	Graisse plateau pour grill 2.2 kw.	Fat tray for grill 2.2 kw.	8,05
69176	R69166J	Resistencia superior grill 2,2-4,4 kw.	Resistor superieure p/grill 2.2-4.4 k	Upper resistance for grill 2.2-4.4	36,75
69176	R69166K	uz hot grill electrico 2.2- 4.4 kw	umiere hot electriq. grill 2.2-4.4 kw	Hot light f/electric grill 2.2- 4.4 kw.	8,55
69177	R69166A	Resistencia inferior. grill 2,2-4,4 kw.	Resistor inferieure p/grill 2.2-4.4 k	Inferior resistance for grill 2.2-4.4	38,05
69177	R69166B	Termostato grill electrico 2.2-4.4 kw	Thermostat pour électrique grill 2.2-4.4	Thermostat for electric grill 2.2-4.4 kw	48,05
69177	R69166C	Mando termostato grill 2,2-4,4 kw.	Thermostat commande pour grill 2.2-4.4 k	Thermostat control for grill 2.2-4.4 kw.	3,55

Ref.	Repuesto	Descripción	Description	Description	€
69177	R69166D	uz power grill electrico 2.2-4.4 kw	umiere power electriq. grill 2.2-4.4 kw	Power light f/electric grill 2.2-4.4 kw.	8,95
69177	R69166E	2 pies de coma grill elec. 2,2-4,4 kw.	2 pied en caoutchouc pour grill 2.2-4.4	2 rubber feet set for grill 2.2-4.4 kw.	4,90
69177	R69166G	Empuñadura grill electrico 2,2-4,4 kw.	Poignée pour electrique grill 2,2-4,4 kw	Handle for electric grill 2,2-4,4 kw.	4,90
69177	R69166J	Resistencia superior grill 2,2-4,4 kw.	Resistor superieure p/grill 2.2-4.4 k	Upper resistance for grill 2.2-4.4	36,75
69177	R69166K	uz hot grill electrico 2.2- 4.4 kw	umiere hot electriq. grill 2.2-4.4 kw	Hot light f/electric grill 2.2- 4.4 kw.	8,55
69177	R69167F	Cable conexon grill elec. 4,4 kw.	Câble branchement pour grill 4.4 kw	Power cord for electric grill 4.4 kw	13,95
69177	R69167H	Bandeja recogegrasas grill 4,4 kw.	Graisse plateau pour grill 4,4 kw	Fat tray for grill 4,4 kw	9,95
69179	R69179A	Cubeta recogegrasas grill profesional 6k	Seau professionnel de gril de 6k	Professional grill fat collection tray	24,10
69179	R69179B	Mando temperatura grill profesional 6k	Contrôle de la température du gril professionnel 6k	Professional grill temp.control knob	4,50
69179	R69179C	Pie goma grill profesional 6kw	Grille professionnelle en caoutchouc 6kw	Professional grill 6 kw rubber feet	1,55
69179	R69179D	uces panel(2 pcs) grill profesional 6kw	Panneau de lumières (2 pièces) grill professionnel 6kw	Professional grill lights (2 pcs)	2,75
69179	R69179E	Termostato+sonda grill profesional 6kw	Thermostat + sonde grill 6kw professionnelle	Professional grill 6kw thermostat+probe	33,05
69179	R69179F	Resistencia1.5 kw grill profesional 6kw	Résistance1.5 kw grill professionnel 6kw	Profess.grill 6kw heating element 1.5 kw	48,35
69179	R69179G	Cable potencia grill profesional 6kw	Câble d'alimentation de grill professionnel 6kw	Professional grill 6kw power cord	15,25
69178	R69178S	Puerta armario refr.black line 8 bot.	Porte p/refroid.black line 8 bou.	Door for 8 bott. wine cellar black line	41,20
69180	R69180A	Cestillo colador vapor mycook	Panier passoire vapeur mycook	Mycook steam strainer basket	26,15
69180	R69180B	Junta silicona tapa mycook	Joint silicone couvercle mycook	Mycook silicon lid ring	6,80
69180	R69180C	Tapa jarra mycook	Couvercle bol mycook	Mycook jug lid	7,00
69180	R69180D	Paleta mezcladora mycook	Mélangeur mycook	Mycook mixing trowel	1,40
69180	R69180E	Espatula completa mycook	Spatule complète mycook	Mycook complete spatula	9,05
69180	R69180F	Cuchillas mycook	ames mycook	Mycook blades	56,45
69180	R69180G	Vaso dosificador mycook	Verre doseur mycook	Mycook measuring glass	1,75
69180	R69180H	Bandeja plastica vapor mycook	Panier plastique vapeur mycook	Mycook plastic steam tray	3,45
69180	R69180J	Tapa bandeja metalica mycook	Couvercle panier métallique mycook	Mycook metallic tray lid	4,70
69180	R69180K	Bandeja metalica con asa mycook	Panier métallique à anse mycook	Mycook metallic tray with handle	167,60
69180	R69180L	Brida fijacion cuchillas jarra mycook	Bride pour fixation du lamé mycook	Mycook jug blades locking base	8,25
69180	R69180M	Junta silicona cuchillas mycook	Joint silicone lame pour mycook	Silicone ring for mycook blades	5,60
69183	R69183M	Caja de engranajes para 69183	Engrenage set pour 69183	Gear box for 69183	10,60
69183	R69183P	Eje central para 69183	Axe central pour 69183	Central axis for 69183	16,30
69183	R69183Q	Eje central para batidora amasador 300w	Axe central pour 69184	Central axis for 69184	13,00
69183	R69183R	Set engranajes para 69184	Engrenage set pour 69184	Gear set for 69184	22,40
69183	R69183S	Varilla batidor batidora-amasadora (new)	Fouet batteur mixeur-pétrisseur (new)	Rod blender blender-kneader(new)	5,30
69183	R69183T	Varilla mezcladora batidora-amas. (new)	Fouet mélangeur mixeur pétriss. (new)	Mixer rod blender-kneader (new)	5,70
69183	R69183W	Varilla amasadora batidora-amas. (new)	Fouet pétrisseur mixeur pétriss. (new)	Kneader blender rod kneader (new)	5,70
69183	R69183Z	Motor para 69183	Moteur pour 69183	Motor for 69183	43,95
69183	R69183AA	Correa de transmision para 69183	Courrie de transmis. Pour 69183	Mixer engine belt for 69183	2,55
69184	R69184A	Varilla batidor batidora-amasadora 1200w	Fouet batteur mixeur-pétrisseur 1200 w.	Rod blender blender-kneader 1200 w.	5,80
69184	R69184B	Varilla mezcladora batidora-amas. 1200w.	Fouet mélangeur mixeur pétriss. 1200 w.	Mixer rod blender-kneader 1200 w.	83,45
69184	R69184C	Varilla amasadora batidora-amas. 1200 w	Fouet pétrisseur mixeur pétriss. 1200 w	Kneader blender rod kneader 1200 w.	6,20
69184	R69184D	Bol inox 6 l batidora-amasadora 1200 w	Bol inox 6 l mixeur-pétrisseur 1200 w	6 l st. steel bowl for 1200 w mixer	33,90
69184	R69184E	Protector anti-salpicaduras para 69184	Éclaboussure protecteur pour 69184	Splash protector for 69184	16,30
69184	R69184F	Tapa anti-salpicaduras para bol 6 l	Couvercle anti éclaboussures pourbol 6l	Splash cover for bowl 6 l	4,70
69184	R69184G	Set 6 patas silicona para 69184	Set 6 pieds de silicone pour 69184	6 rubber feet set for 69184	3,95
69184	R69184H	Muelles apertura tapa batid. amasad. 6l	Printemps ouverture de couverture 69184	Cover springs for 69184	0,60
69184	R69184J	Placa control batidora amasadora 6l 1200w	Tableau commande principal para 69184	Main control board for 69184	24,20
69184	R69184K	Set engranajes eje giratorio para 69184	Engrenage a axes set pour 69184	Axis gear set for 69184	18,40
69184	R69184L	Base para jarra de batid. amas. 6l 1200w	Aide de base pour 69184	Bowl support base pour 69184	9,65
69184	R69184S	Puerta izquierd refr.black line 48 bot.	Gauche porte p/refroid. 48 bou.	Left door for 48 bott. Wine cellar	102,95
69184	R69184W	Puerta derecha refr.black line 48 bot.	Droite porte p/refroid. 48 bou.	Right door for 48 bott. Wine cellar	102,95
69185	R69071	Tarjeta luz inter. arm. 8-16-28-48 bot.	Carte lumière p/refroid. vin 8-16-28-48	Inter. light card 8-16-28-48 b. wine cel	5,00
69185	R69185B	Bisagra puerta para 69185	Charniere de porte pour 69185	Door hinge for 69185	5,60
69185	R69185C	Ventilador de aire caliente para 69185	Soufflerie d air chaud para 69185	Hot air fan for 69185	10,05
69185	R69185D	Bloque enfriador para armario 69185	Bloc refroidisseur pour 69185	Cooling system for 69185	88,85
69185	R69071E	Bisagra inferior puert. arm. 8-16-28 bot	Charnière inferieur p/refroid. 8-16-28 b	Down door ream f/8-16-28 bott. wine cell	3,15
69186	R69071G	Cable+enchufe arm. 8-16-28-48 bot.	Câble+prise p/ 8-16-28-48 ref. à vin	Cable+plug for 8-16-28-48 bo wine cellar	8,25
69186	R69071M	Bisagra superior puerta arm. 8-16-28 bot	Charnière superieure p/refro. 8-16-28 bo	Top hinge f/8-16-28 bott. wine cellar	3,15
69186	R69074D	Parrilla 3 bot. arm. 48 botellas	3 bou. grill pour refr. à vin élec. 48 b	3 bot. grill for 48 bot. wine cellar	5,00
69186	R69185A	Placa control temperatura para 69185	Température pcb controle pour 69185	Temperature control pcb for 69185	21,25
69186	R69185S	Puerta armario refr.black line 18 bot.	Porte p/refroid.black line 18 bou.	Door for 18 bott. wine cellar black line	60,05
69186	R69186A	Ventilador de aire caliente para 69186	Soufflerie d air chaud para 69186	Hot air fan for 69186	14,15
69186	R69186B	Ventilador aire frio para 69186	Ventilateur refroidissement pour 69186	Cool air fan for 69186	10,70
69186	R69186C	Bloque enfriador para armario 69186	Bloc refroidisseur pour 69186	Cooling system for 69186	83,85
69186	R69186S	Puerta armario refr.black line 16 bot.	Porte p/refroid.black line 16 bou.	Door for 16 bott. wine cellar black line	58,90
69187	R69187S	Puerta armario refr.black line 8 bot.	Porte p/refroid.black line 8 bou.	Door for 8 bott. Wine cellar black line	102,95
69192	R69192A	Panel De Control Sous Vide 69192	Panneau Commande Sous Vide 69192	Control Panel Sous Vide Immersion Cooker	49,35
69192	R69192B	Ventilador Para Sous Vide 69192	Ventilateur Commande Sous Vide 69192	Fan For Sous Vide Immersion Cooker	13,45
69192	R69192C	Elemento Calentado Sous Vide 69192	Chauffant Element Pour Sous Vide 69192	Heating Eleme Sous Vide Immersion Cooker	18,20
69192	R69192D	Sensor De Temperatura Sous Vide 69192	Température Capteur Pour Sous Vide 69192	Temp Sensor Sous Vide Immersion Cooker	20,85
69192	R69192E	Nterruptor On-Off Sous Vide 69192	On-Off Switch Sous Vide 69192	On-Off Switch Sous Vide Immersion Cooker	2,85
69192	R69192F	Bomba De Agua Para Sous Vide 69192	Pompe A Eau Pour Sous Vide 69192	Water Pump For Sous Vide 69192	14,15
69192	R69192G	Termostato + boton reset 69192	Thermostat + reset pour sous vide 69192	Thermostat + rest button sous vide 69192	26,45



Ref.	Repuesto	Descripción	Description	Description	€
69192	R69192H	Pomo sujeccion sous vide 69192	Poignée de maintien pour sous vide 69192	locking knob for sous vide 69192	7,10
69193	R69193A	Parrila De Coccion Cocedor Sous Vide	Gril Pour Cuisson Four Eau Sous Vide	Cooking Rack For Sous Vide Water Oven	52,00
69193	R69193B	Panel De Control Horno De Agua Sous Vide	Panneau Commande Four Eau Sous Vide	Control Panel Sous Vide Water Oven	13,45
69193	R69193C	Ventilador Para Horno De Agua Sous Vide	Ventilateur Pour Four Eau Sous Vide	Fan For Sous Vide Water Oven	41,80
69193	R69193D	Bomba De Agua Para Horno Agua Sous Vide	Pompe A Eau Pour Four Eau Sous Vide	Water Pump For Sous Vide Water Oven	41,80
69193	R69193E	Tapa Para Horno De Agua Sous Vide	Couvercle Pour Four Eau Sous Vide	Lid For Vide Water Oven	44,15
69193	R69193F	Sensor Nivel Agua Horno Agua Sous Vide	Capteur Niveau D Aeu Four Eau Sous Vide	Water level Sensor Sous Vide Water Oven	5,70
69193	R69193G	Elem. Calentador Horno De Agua Sous Vide	Placa Chauffante Pour Four Eau Sous Vide	Heating Plate For Sous Vide Water Oven	53,95
69193	R69193H	Bandeja Coccion Horno De Agua Sous Vide	Grille De Cuisson Four Eau Sous Vide	Cooking Rack Sous Vide Water Oven	10,60
69194	R69194A	Jarra batidora electrica 750w 1.7 lts	Carafe p/ batteur électrique 750w 1.7 lt	750 w table blender glass jug 1.7 lts	39,05
69194	R69194B	Botonera batidora electrica 750w 1.7 lts	Boutonnière batteur électrique 750w 1.7	750 w table blender button panel set	24,10
69194	R69194C	Motor batidora electrica 750w 1.7 lts	Moteur batteur électrique 750w 1.7 lts	750 w table blender electr.motor	46,00
69194	R69194D	Tapa batidora electrica 750w 1.7 lts	Couvercle batteur électrique 750w 1.7 lt	750 w table blender jug lid	2,95
69194	R69194E	Jgo cuchilla batidora elec.750w 1.7lt	Ensemble lame batteur électrique 750w 1.	750 w table blender blade+gasket set	7,55
69194	R69194F	Embrague inferior para 69194	Embrayage inférieur pour 69194	Clutch lower for 69194	0,70
69194	R69194G	Placa control batidora 750w 1.7l	Controlleur de commande pour 69194	Pc board for 69194	9,65
69194	R69194H	Conjunt motor control 69194	Moteur pour 69194	Engine for 69194	74,90
69194	R69194K	Conector de la jarra para 69194	Connecteur de jarre pour 69194	Jar connector for 69194	2,15
69194	R69194I	Junta silicona jarra para 69194	Joint de silicone pour 69194	Jar silicon gasket for 69194	5,70
69194	R69194M	Junta de silicona para 69194	Joint en silicone pour 69194	Silicon gasket for 69194	4,05
69195	R69195A	Jarra batid.elec.profes.950ws/tapa+s/cuc	Pot batteur élec.profes.950w s/couv&lame	Profess.electr.blender jug w/o lid&blade	47,10
69195	R69195B	Tapa batidora elec. profesional 950 w.	Couvercle pour batteur elec.profes. 950w	Jug lid profesional electric blender	43,35
69195	R69195C	Empujador batidora elec. prof. 950 w.	Pousseur batteur elec. prof. 950 w.	Profesional elec. blender pusher 950 w.	17,80
69195	R69195D	Soporte goma batidora elec. prof. 950 w.	Support en caoutchouc batteur élec. prof	Profesional elec. blender rubber cover	21,15
69195	R69195E	Cuchilla batidora elec. prof. 950 w.	ame pour batteur élec. prof. 950 w.	Prof. elec. blender blade set	58,90
69195	R69195F	Interruptor batidora profesional 950w	Interrupteur pour mélangeur électrique	Switch for professional elec.blender	3,35
69195	R69195G	Cable potencia bat. elec. prof. 950 w.	Câble puissance pour batteur 950 w.	Prof. elec. lendar power cord	8,45
69195	R69195H	Conector motor batid. elec. prof. 950 w	Connecteur moteur pour batteur 950 w.	Profesional elec. blender connection par	18,50
69195	R69195I	Motor batidora elec. prof. 950 w.	Moteur pour batteur élec.prof.950w	Prof. elec. blender 950 w. motor	110,10
69195	R69195K	Placa control bat. elec. prof. 950 w.	Plaque du control pour batteur 950 w	Prof. elec. blender control card	58,90
69195	R69195I	Botonera batidora profesional 950w	Keypad pour mélangeur électrique profess	Professional elec.blender bouton card	2,75
69195	R69195M	Pies goma de bat. elec. prof. 950 w.(4)	Pied en caoutchouc p/batteur 950 w.(4)	Prof. elec. blender rubber feets (4)	4,05
69195	R69195N	Jarra batid.elec. profes.950w c/cuchilla	Pot batteur élec. profes. 950 w.a/lame	950w blender jug w/blades	155,80
69195	R69195P	Tuerca batidora electrica profesion.950w	Vis pour pot batteur élec.profes.950w	950w professional blender jug nut	18,95
69195	R69195Q	Escobillas+fundas para 69195	Brosses + sacs pour 69195	Brushes + bags for 69195	27,90
69195	R69195R	- código libre -	Pied en caoutchouc pour 69195 (4 pcs.)	4 pcs. rubber feet set for 69195	5,00
69195	R69195T	Llave fijacion cuchilla	Clé de blocage de lame	Key lock blade	6,70
69195	R69195S	Escobilla de carbon para motor 69195	Balai de charbon para 69195 moteur	Carbon brush for 69195 motor	11,70
69195	R69195W	Conector motor nuevo para 69195	Connecteur moteur nouveau pour 69195	New connector cluth for 69195	17,80
69195	R69195X	Recetario batidora 69195	Recettes batteur 69195	Recipe book for blender 69195	5,10
69196	R69196A	Resistencias calentadoras para crepera	Element de chauffage	Heating element	27,55
69196	R69196B	Set del termostato	Jeu du thermostat	Thermostat set	11,00
69196	R69196C	Switch+luzes de encendido y calentamien	Switch + puissance et feux de chauffage	Switch+power and heating lights	5,30
69196	R69196D	Bandeja de residuos	Bac a dechets	Waste tray	24,60
69196	R69196E	Placa de cocina	Plaque de cuisson	Cooking plate	140,00
69197	R69197A	Resistencias calentadoras para salamandr	Element de chauffage	Heating element	27,55
69197	R69197B	Set del termostato	Jeu du thermostat	Thermostat set	19,75
69197	R69197C	Switch+luzes de encendido y calentamien	Switch + puissance et feux de chauffage	Switch+power and heating lights	2,75
69197	R69197D	Grill para salamandra	Calandre pour 69197	Grill for 69197	28,50
69197	R69197E	Bandeja recoje aceite	Pick huiles plateau	Oil fta tray	46,70
69197	R69197F	Asa tapa superior	Poignée	Handle	6,00
69197	R69197G	Pies de goma (2)	Pieds en caoutchouc (2)	Rubber feets (2)	0,70
69197	R69197H	Set de engranajes	Set de vitesse	Gears set	5,30
69197	R69197J	Cadena para salamandra	Chaîne	Chain	21,25
69200	R69200A	Placa grill + lisa para 69200	Plaque grill + lisser pour 69200	Grill + smooth fur plate for 69200	58,00
69201	R69201A	Resistencia + set termostato barbacoa	Résistance + thermostat set barbecue	Resistance + barbecue set thermostat	15,75
69201	R69201B	Parrilla + plancha grill para barbacoa	Grill pour barbecue	Grill + griddle grill for barbecue	19,75
69201	R69201C	Bandeja recoge grasas para barbacoa	Bac recueille la graisse pour barbecue	Tray collects grease for barbecue	3,25
69201	R69201D	Bandeja y cuerpo plastico para barbacoa	Plateau et base en plastique pour barbec	Tray and base plastic for barbecue	8,55
69201	R69201F	Set 4 patas barbacoa	Définir quatre signaux pour barbecue	Set four feeds for barbecue	5,90
69211	R69211	Repuesto tapon carro cestas lavavajillas	Bouchon découlement	Spare part plug for rack trolley	1,40
69212	R69211	Repuesto tapon carro cestas lavavajillas	Bouchon découlement	Spare part plug for rack trolley	1,40
69212	R69212	Barra carro porta cestas	Poignée inoxydable pour chariot glissier	S.steel handlebar for racks trolley	66,25
69212	R69212A	Rueda con freno para carro porta-cestas	Roue avec frein pour paniers de trans	Rack trolley spare wheel w/brake	32,25
69223	R69223A	Tapa deshidratador de alimentos 69223	Couvercle deshydrateur des aliments 6922	Lid for food dehydrator 69223	6,70
69223	R69223B	Compartimento deshidratador 69223	Compartiment deshydrateur de aliments 69223	Compartment for food dehydrator 69223	6,70
69223	R69223C	Base giratoria para 69223	Base pivotante pour 69223	Rotatory base for 69223	17,90
69223	R69223D	Placa electronica para 69223	Carte principale électronique pour 69223	Electronic main board for 69223	17,90
69223	R69223E	Placa control botonera para 69223	Tableau commande électronique pour 69223	Electronic control board for 69223	17,90



Ref.	Repuesto	Descripción	Description	Description	€
69223	R69223F	Resistencia para 69223	Element chauffant pour 69223	Heating resistance for 69223	6,10
69223	R69223G	Motor para 69223	Moteur pour 69223	Motor for 69223	13,45
69223	R69223I	Recetario deshidratador terra 69223	Recettes deshydrateur des aliments terra	Recipe book for terra food dehydrator	2,75
	69261	R69261A Motor para afilador de cuchillos 80w	Moteur affûteuse couteaux electrique 80w	Motor knife sharpener 80w	2,25
	69261	R69261B Disco afilador p/cuchillos lisos finos	Lisse fine couteau affutage disque	Thin smooth knife sharpening disc	28,10
	69261	R69261C Disco afilador p/cuchillos lisos	Disque couteau affutage disque	Smooth knife sharpening disc	28,10
	69261	R69261D Disco afilador para cuchillos dentados	Affilage disque pour dentelee couteaux	Sharpening disc for serrated knives	1,10
	69263	R69263A Lámpara infrarrojos 275 w	Lampe infrarouge 275 w	275 w infrared heating bulb	12,30
	69263	R69263B Tulipa de lámpara 275 w	Couvercle de lampe 275w pour 69263-4	275 w bulb trim for 69263-4	122,30
	69263	R69263C Zocalo cerámico para lámpara 275w	De douilles en ceramique pour 69263-4	Ceramic lamp socket for 69263-4	4,15
	69266	R69266A Lámpara aluminio satinado para 69266	Protection d aluminium pour 69266	Bulb aluminum cover for 69266	42,95
	69266	R69266B Set de montaje techo para 69266	Ensemble toit set pour 69266	Roof assembly set for 69266	6,50
	69266	R69266C Set de montaje viejo techo para 69266	Vieux ensemble toit set pour 69266	Old roof assembly set for 69266	6,50
	69270	R69270A Jarra-filtro pequeño inoxidable	Carafe-filtre petit pour machine `café	St. steel small filter-jug	16,30
	69270	R69270B Set caldera + resistencia calentadora	Chaudiere + resistance de chauffage	Bolier tank + heating element set	3,35
	69270	R69270C Interruptor para cafetera 69270	Change pour 69270	Switch for 69270	1,10
	69270	R69270D Set deposito+ interruptor boyas	Set réservoir + interrupteur à flotteur	Set reservoir + float switch	1,10
	69270	R69270E Aspersor de agua para 69270	Arroseur pour 69270	Sprinkler for 69270	1,10
	69270	R69270F Relé para cafetera 69270	Relais pour 69270	Relay for 69270	1,10
	69270	R69270G Cable de 230v para 69270	230v cordon pour 69270	230v wire for 69270	1,10
	69271	R69271A Jarra-filtro grande inoxidable	Carafe-filtre grand pour machine à café	St. steel big filter-jug	21,65
	69271	R69272A Set caldera + resistencia calentadora	Chaudiere + resistance de chauffage	Bolier tank + heating element set	78,35
	69271	R69272B Interruptor boyas + junta silicona	Flotteur + joint en silicone	Float switch + silicone gasket	16,50
	69271	R69272D Interruptor + led para cafetera 69270	Change + led pour 69270	Switch + led for 69270	9,55
	69271	R69272E Tapa + filtro para depósito	Pac + filtre pour dépôt	Cap + filter for deposit	9,45
	69271	R69272F Patas de goma para 69272	Jambes pour 69272	Legs for 69272	1,95
	69271	R69272G Aspersor de agua para 69272	Arroseur pour 69272	Sprinkler for 69272	37,95
	69272	R69271A Jarra-filtro grande inoxidable	Carafe-filtre grand pour machine à café	St. steel big filter-jug	21,65
	69272	R69272A Set caldera + resistencia calentadora	Chaudiere + resistance de chauffage	Bolier tank + heating element set	78,35
	69272	R69272B Interruptor boyas + junta silicona	Flotteur + joint en silicone	Float switch + silicone gasket	16,50
	69272	R69272D Interruptor + led para cafetera 69270	Change + led pour 69270	Switch + led for 69270	9,55
	69272	R69272E Tapa + filtro para depósito	Pac + filtre pour dépôt	Cap + filter for deposit	9,45
	69272	R69272F Patas de goma para 69272	Jambes pour 69272	Legs for 69272	1,95
	69272	R69272G Aspersor de agua para 69272	Arroseur pour 69272	Sprinkler for 69272	37,95
	69272	R69272H Sensor ptc de temperatura para 69272	Capteur de temperature pour 69272	Ptc temperature sensor for 69272	10,90
	69272	R69272J Resistencia de calentamiento para 69272	Resistance de chauffage pour 69272	Heating resistance for 69272	18,50
	69272	R69272K Panel plástico frontal para 69272	Facade plastique pour 69272	Lower frontal plastic for 69272	5,50
	69272	R69272L Resistencia ptc calentamiento para 69272	Resistance de chauffage ptc 69272	Mica warming plate 69272	7,10
	69272	R69272M Placa calentamiento jarra 69272	Plaque chauffante du verre pour 69272	Coffee glass warming plate	31,65
	69273	R69273A Tapa plástico jarra café cristal 69273	Plastique couvercle pour 69273	Plastic lid for glass coffee jug 69273	1,65
	69276	R69276A Base conectora 69276	Connecteur de base pour 69476	Base connector for 69476	13,25
	69276	R69276B Tapa para hervidor cerámico 69276	Couvercle pour 69276	Ceramic lid for kettle 69276	9,05
	69277	R69277A Base conexi. hervid. agua elec. 1,7lt 2400w	Base branchement bouilloire elec. 1,7 lt	1.7 lts electric kettle connection base	6,70
	69277	R69277B Tapa hervidor agua eléctrico 1,7lt 2400w	Couvercle p/bouilloire électrique 1,7 lt	1.7 lts electric kettle spare lid	1,10
					0,00
					0,00
	69280	R69280A Cono+acople exprimidor mini 85w	Cône+adapteur presse fruits 85 w	Electric orange squeezer cone+adaptor	2,25
	69280	R69280B Contenedor+filtro exprimidor mini 85 w	Container+filtre presse fruits mini 85w	Electric orange squeezer container+filter	5,00
	69280	R69280C Tapa exprimidor mini 85 w	Couvercle presse-fruits	Electric orange squeezer lid	2,25
	69280	R69280D Set repuestos interiores exprim. eléctrico	Set pièces détachées p/presse fruits élé	Set interior spares for electric squeezer	22,60
	69282	R69282A Set base calentadora para jarra café	Chauffage base pour la cafetière	Heating base for coffee pot	32,15
	69283	R69283H Eje motor para exprimidor 69283	Axe moteur de base pour 69283	Motor axis for orange juicer 69283	8,75
	69283	R69283I Motor para exprimidor 69283	Moteur pour 69283	Motor orange juicer 69283	189,35
	69284	R69284A Cono mini licuadora fruta+batidora 400w	Cône inox pour centrifugeuse+blender 400	400w mini fruit processor st. steel cone	6,70
	69284	R69284D Cabezal transparente licuadora mini 400w	Couvercle mini centrifugeuse+blender 400	400w mini fruit processor transpar.cover	5,60
	69284	R69284E Jarra blender licuad.+batidora mini 400w	Jarre polycarb.pour centrif+blender 400w	400w fruit process+blender pc jug	13,35
	69284	R69284G Contenedor desper.mini licuad+batid 400w	Bac à déchets mini centrifugeuse+blen400	400w fruit process+blender waste contain	2,25
	69284	R69284J Jarra zumo mini licuadora+batidora 400 w	Carafe en plastic pour centrif+blen 400w	400w mini fruit proces+blender juice jug	2,75
	69284	R69284K Motor blender licuad.+batidora mini 400w	Ensemble motor pour centr.+blender 400w	400 w fruit process+blender motor set	63,40
	69284	R69284L Bloque interm. licuadora+batidora 400w	Emsemble intermède centrif.+blender 400w	400w fruit process+blender middle part	9,95
	69285	R69285A Cono + inserto exprimidor 85w	Presse pour presse-fruits 85w	Plastic cone+insert elec.orange squee.85w	7,75
	69285	R69285B Bandeja filtro exprimidor c/brazo 85 w	Filtre pour presse fruits electrique 85w	85w st.st filter tray elec.orange squee.	14,05
	69285	R69285C Brazo repuesto exprimidor mini 85 w	Lever p/presse fruits mini 85w	85w electric orange squeezer spare lever	3,35
	69285	R69285D Bandeja plástico exprimidor 69285	Plastique plateau pour presse 69285	Plastic tray for squeezer 69285	3,35
	69285	R69285E Repuestos varios para 69285	Pièces détachées pour 69285	Spare parts for 69285	5,60
	69286	R69286A Recoge zumos + filtro 69286	Etape de base pour 69286	Pick fruit + filter for 69286	3,85
	69286	R69286B Cono de exprimir para 69286	Tête extrancting extérieur pour 69286	Outer extrancting head for 69286	8,95

Ref.	Repuesto	Descripción	Description	Description	€
69286	R69286D	Cable potencia para 69286	Ff	Power wire for 69286	2,65
69286	R69286E	Motor para 69286	Moteur pour 69286	Motor for 69286	86,80
69286	R69286F	Switch on off	Interrupteur on off 69137	Switch on off for 69137	7,75
69286	R69286G	Tapa cubre salpicaduras para 69286	Couverture de splash pour 69286	Splash cover for 69286	4,15
					0,00
					0,00
69288	R69288A	Jarra pastico licuadora de fruta 69288	Pot en plastique pour 69288	Plastic jar elec. juice extractor 69288	4,00
69288	R69288B	Empujador para licuadora fruta 69288	Poussoir pour 69288	Pusher for juice extractor 69288	5,65
69288	R69288C	Tapa pastico licuadora de fruta 69288	Couvercle en plastique pour 69288	id elec. juice extractor 69288	13,45
69288	R69288D	Filtro inox licuadora de fruta 69288	Filtre pour 69288	Inox filter elec. juice extractor 69288	3,30
69288	R69288E	Contenedor de zumo para licuadora 69288	Contenant de jus pour 69288	Juice container juice extractor 69288	3,05
69288	R69288F	Conector motor para licuadora 69288	Connecteur du moteur pour 69288	Motor conector juice extractor 69288	3,80
69288	R69288G	Set 4 patas licuadora de fruta 69288	Set 4 pieds pour 69288	Set 4 feet elec. juice extractor 69288	2,85
69288	R69288H	Contenedor de desechos licuadora 69288	Recipient a dechets pour 69288	Waste container juice extractor 69288	4,90
69288	R69288J	Interruptor licuadora de fruta 69288	Interrupteur pour 69288	Switch for juice extractor 69288	1,90
69288	R69288K	Palanaca apertura tapa para 69288	evier d ouverture pour 69288	Switch for juice extractor 69288	7,85
69288	R69288L	Palanaca apertura derecha para 69288	evier d ouverture droit pour 69288	Right switch for juice extractor 69288	7,55
					0,00
					0,00
69291	R69291A	Base conectora 1 lt. 1650w	Connecteur de base 1 lt. 1650w	Base connector 1 lt. 1650w	5,60
69291	R69291B	Interruptor 1 lt. 1650w	Commutateur 1 lt. 1650w	Switch 1 lt. 1650w	5,60
69291	R69291D	Regulador de hervidor 1 lt. 1650w	Contrôleur pour bouilloire 1 lt. 1650w	Controller for kettle 1 lt. 1650w	2,35
					0,00
					0,00
69294	R69294A	Bandeja recogemigas tostad.buffer inox 4	Plaque à ramasse-miettes pour grille-pai	4 slots buffet toaster crumbs tray	11,20
69294	R69294B	Interruptor selec.tostador buffet inox 4	Interrupteur pour grille-pain buffet	Buffet toaster selector swicht	4,50
69294	R69294C	Temporizador tostador buffet inox 4-6	Minuterie pour grille-pain buffet	Buffet toaster timer switch	8,45
69294	R69294D	Palanca+pomo tostador buffet inox 4-6	evier+bouton pour grille-pain buffet	Buffet toaster lever+knob	4,50
69294	R69294E	Cable potencia tostador buffet inox 4-6	Câble puissance pour grille-pain buffet	Buffet toaster power cord	10,60
69294	R69294F	Resistencia tostad.buffer inox 4	Resistance chauffante pour grille-pai 4	4 slots buffet toaster heating element	21,05
					0,00
					0,00
69296	R69296A	Bandeja recogemigas tostad.buffer inox 4	Plaque à ramasse-miettes pour grille-pai	4 slots buffet toaster crumbs tray	11,20
69296	R69296B	Interruptor selec.tostador buffet inox 4	Interrupteur pour grille-pain buffet	Buffet toaster selector swicht	4,50
69296	R69296C	Temporizador tostador buffet inox 4-6	Minuterie pour grille-pain buffet	Buffet toaster timer switch	8,45
69296	R69296D	Palanca+pomo tostador buffet inox 4-6	evier+bouton pour grille-pain buffet	Buffet toaster lever+knob	4,50
69296	R69296E	Cable potencia tostador buffet inox 4-6	Câble puissance pour grille-pain buffet	Buffet toaster power cord	10,60
69296	R69296A	Bandeja recogemigas tostad.buffer inox 6	Plaque à ramasse-miettes pour grille-pai	6 slots buffet toaster crumbs tray	13,95
					0,00
					0,00
69297	R69297C	Filtro 1 lt. 1650w	Filtre 1 lt. 1650w	Filter 1 lt. 1650w	5,60
69297	R69297A	Base conectora 1.7 lt. 2200w	Connecteur de base 1.7 lt. 2200w	Base connector 1.7 lt. 2200w	5,60
69297	R69297B	Interruptor 1.7 lt. 2200w	Commutateur 1.7 lt. 2200w	Switch 1.7 lt. 2200w	5,60
69297	R69297C	Filtro 1.7 lt. 2200w	Filtre 1.7 lt. 2200w	Filter 1.7 lt. 2200w	5,60
69300	R69300A	Disco de rotura para 69300/1	Disque de rupture pour 69300/1	Break disc for 69300/1	10,20
					0,00
					0,00
69302	R69302A	Soporte amarre para sous vide 69302	Support du bridage pour 69302	Clamping bracket for 69302	22,80
69302	R69302B	Motor + helice + sensor temp/nivel 69302	Moteur+helice+sonde temp/niveau 69302	Motor+helix+ temp/level sensor 69302	42,55
69302	R69302C	Placa principal sous vide 69302	Carte principale pour 69302	Main board for 69302	40,40
69302	R69302D	Panel de control sous vide 69302	Panneau commande sous vide 69302	Control panel board for 69302	32,05
69302	R69302E	Ventilador para sous vide 69302	Ventilateur pour 69302	Fan for 69302	14,45
69302	R69302F	Cuerpo inoxidable sous vide 69302	Corps inox pour 69302	Stainless steel body for 69302	16,90
69302	R69302I	Recetario cocedor baja temperat.portátil	ivre recettes cuisiniere a basse temp.	Recipe book for portable sous vide	15,25
69303	R69303A	Soporte amarre para sous vide 69303	Support du bridage pour 69303	Clamping bracket for 69303	22,80
					0,00
					0,00
69307	R69307A	Tapa horno halogeno cristal 7 lt 800w	Couvercle four convention halogène 7l	Spare lid convent.halogen glass oven 7l	41,90
69307	R69307B	Rack alto horno halogeno cristal 7lt	Rack haute de convention d'halogène 7l	Spare high rack conv.halogen oven 7l	1,75
69307	R69307C	Rack bajo horno halogeno cristal 7 lt	Rack basse de convention d'halogène 7l	Spare low rack conven.halogen oven 7l	1,40
69307	R69307E	Aro extensio.horno halogeno cristal 7 lt	Cercle de convention d'halogène 7l	Extender ring conven.halogen oven 7l	3,75
69307	R69307F	Soporte tapa horno halogeno cristal 7lt	Support couvercle de convent.d'halo 7l	id holder convention halogen oven 7l	1,75
69307	R69307G	Plato perfor.horno halogeno cristal 7lt	Assiette perforé convention d'halog 7l	Steamer convention halogen oven 7l	1,75
69307	R69307H	Plato asar horno halogeno cristal 7lt	Assiette à rôti convention d'halog 7l	Frying pan convention halogen oven 7l	2,55
69307	R69307J	Pincho bbq 4pcs horno halog. cristal 7l	Brochette à bbq convent. d'halogène 7l	4pcs skewe.convention halogen oven 7l	1,10
69307	R69307K	Rack tostadas horno halogeno cristal7lt	Grille pour toast conven.d'halogène 7l	Bread rack convention halogen oven 7l	1,10
					0,00
69308	R69308A	Contenedor para 69308	Conteneur pour 69308	Container for 69308	4,70
69308	R69308B	Tapa de cristal para 69308	Dessus en verre pour 69308	Glass lid for 69308	9,35
69308	R69308C	Rejilla baja para 69308	Grille du bas pour 69308	low rack for 69308	2,35
69308	R69308D	Movedor para 69308	En mouvement pour 69308	Moving for 69308	7,00
69308	R69308E	Tapa superior con resistencia para 69308	Top cap avec resistance pour 69308	Top cap with resistance for 69308	10,70
69308	R69308F	Resistencia inferior para 69308	En dessous resistance pour 69308	Below resistance for 69308	10,70
69308	R69308G	Motor para 69308	Moteur pour 69308	Engine for 69308	11,60
69308	R69308H	Selector de temperatura para 69308	Temperature selecteurpour 69308	Temperature selector for 69308	4,70
69308	R69308I	Temporizador para 69308	Minuteur pour 69308	Timer for 69308	4,70
69308	R69308J	Pies antideslizantes para 69308	Pieds antiderapants pour 69308	Non-slip feet for 69308	0,50
69308	R69308K	Cable para 69308	Cable pour 69308	Cable for 69308	8,35
					0,00
69310	R69310A	Contenedor de hielo picado para 69310	Conteneur de glace ecrase a 69310	Crushed ice container for 69310	2,15
69310	R69310B	Interruptor para picador de hielo elec.	Commutateur pour 69310	Switch for 69310	1,10
69310	R69310C	Set 5 pies de goma para 69310	ot des 5 caoutchouc pieds pour 69310	Set of 5 rubber feet for 69310	0,70
69310	R69310D	Tapa picadora de hielo electrica	Couvercle pour 69310	lid for the ice crusher 6310	1,20

Ref.	Repuesto	Descripción	Description	Description	€
69312	R69312A	Tapa horno halogeno cristal 12 lt 1400w	Couvercle four de convention d'halogène	Spare lid convent.halogen glass oven 12l	34,70
69312	R69312B	Rack alto horno halogeno cristal 12 lt	Rack haute four de convention d'halogène	Spare high rack conv.halogen glass oven	1,55
69312	R69312C	Rack bajo horno halogeno cristal 12 lt	Rack basse four de convention d'halogène	Spare low rack conven.halogen glass oven	1,10
69312	R69312D	Pinzas horno halogeno cristal 12 lt	Pince p/four de convention d'halogène	Spare tongs conven.halogen glass oven	1,10
69312	R69312E	Aro extensio.horno halogeno cristal 12lt	Cercle p/four de convention d'halogène	Extender ring conven.halogen glass oven	4,50
69312	R69312F	Soporte tapa horno halogeno cristal 12lt	Support couvercle four de convent.d'halo	lid holder convention halogen glass oven	2,15
69312	R69312G	Plato perfor.horno halogeno cristal 12lt	Assiette perforé four convention d'halog	Steamer convention halogen glass oven	3,05
69312	R69312H	Plato asar horno halogeno cristal 12lt	Assiette à rôtir four convention d'halog	Frying pan convention halogen glass oven	3,05
69312	R69312J	Pincho bbq 3pcs horno halogeno cristal	Brochette à bbq four convent. d'halogène	3pcs skewe.convention halogen glass oven	1,10
69312	R69312K	Rack tostadas horno halogeno cristal12lt	Grille pour toast four conven.d'halogène	Bread rack convention halogen glass oven	1,10
69312	R69312l	Cable conexion horno halogen.cristal12lt	Câble branchement four convent.d'halogè.	Power cord convention halogen glass oven	4,50
69312	R69312M	Cont.cristal horno halogeno 12 lt 1400w	Cont.verre four convention d'halogène12l	Container convent.halogen glass oven 12l	20,05
69312	R69312N	Base cont. cristal horno conevc 12 lts	Base de contenat en verre convec 12 lts	Base glass container convec oven 12 lts	7,85
	69314	R69314A Contenedor de hielo removible para 69314	Bac a glaçons amovible pour 69314	Removable ice basket for 69314	5,50
	69314	R69314B Panel + placa de control para 69314	Plate + panneau de controle para 69314	Control panel + board for 69314	64,10
	69314	R69314C Compresor para maquina de hielos 69314	Compresseur pour 69314	Compressor for 69314	114,25
	69314	R69314D Bomba de agua + tapon drenaje para 69314	Pompe a eau + bouchon vidange pour 69314	Water + drain pipe pump for 69314	7,35
	69314	R69314E Ventilador para maquina de hielo 69314	Ventilateur pour 69314	Fan for 69314	6,10
	69314	R69314F Condensador maquina de hielo 69314	Coupe pour 69314	Condensor for 69314	11,90
	69314	R69314G Valvula de gas para 69314	Robinet a gaz pour 69314	Gas valve for 69314	13,95
	69314	R69314H Bandeja recogida agua	Plateau pour collect de eau	Water collecting tray	6,50
	69315	R69315A Motor accionado varilla maq.helado	Moteur actionneur du batteur pour sorbet	150 w. ice cream maker motor	22,80
	69315	R69315B Contenedor helado 1,5 lts.	Bac à glace 1,5 lts.	1,5 lts. ice cream bucket	13,35
	69315	R69315C Tapa maq. elaboracion helado	Couvercle pour machine à glace	Ice cream maker lid	3,65
	69315	R69315D Vaso+espatula+batidor maq. helado 150 w.	Verre+spatule+batteur machine à glace150	Ice cream maker whisk+cup	2,95
	69316	R69316A Contenedor pan rectang.18x13,5 cm - 2.7	Conteneur rectang. machine à pain 21x15x	Rectang.bread maker mould 21x15x17 - 2.7	25,25
	69316	R69316B Contenedor pan redondo d.17 cm - 1.5 lts	Conteneur rond machine à pain d.17 -1.5	Round bread maker mould d.17 - 1.5 lts	11,60
	69316	R69316C Contenedor frutos secos maq.pan	Conteneur des fruits sec machine à pain	Dry fruits container for bread maker mac	11,20
	69316	R69316D Maquina elabor.pan vaso+cuchara med.+agi	Verre mesureur mach.à pain+cuilliere mes	Bread maker machine measur.cup+spoon+mix	4,80
	69317	R69317A Cazo baño maria chocolate	Casserole pour bain marie chocolat	Chocolate melter saucepan	8,85
	69318	R69318A Torre inox 3 band.fuente chocolate peq.	Tour inox 3 plateaux petite fontaine à c	Small chocol.fountain 3 tiers tube	6,20
	69318	R69318B Helice fuente chocolate peq.	Spirale petite fontaine à chocolat	Small chocolate fountain spiral	0,50
	69318	R69318C Bandeja fuente chocolate pequena+tor.	Plateau petite fontaine à choco.+ vis	Small chocolate fountain tray+screws	6,70
	69319	R69319A Tubo inox 3 band.fuente chocolate grande	Tour inox 3 plateaux grand fontaine à c	Big chocolate fountain 3 tiers tube	13,95
	69319	R69319B Helice fuente chocolate grande	Spirale fontaine à chocolat grand	Big chocolate fountain spiral	3,05
	69319	R69319C Bandeja fuente chocolate grande+ornillo	Plateau grand fontaine à choco.+ vis	Big chocolate fountain tray+screws	15,05
	69319	R69319D Motor para fuente chocolate 69319	69319 fontaine à chocolat moteur	Motor for chocolate fountain 69319	26,65
	69319	R69319E Set de engranajes para 69139	Train d engranages pour 69319	Gear box set for 69319	5,50
	69320	R69320A Pala recoge cubitos maquina de hielo pro	Glace glaçons pelle pour 69320	Ice cubes scoop for 69320	1,55
	69320	R69320B Tuberia suminist. agua maquina hielo pro	Eau tuyau d approvisionnement pour 69320	Water supply pipe for 69320	11,90
	69320	R69320C Switch on offpara maquina hielos pro	Interrupteur on off 69320	Switch on off for 69320	3,55
	69320	R69320D Puerta para maquina de hielo pro	Porte pour 69320	Door for 69320	17,30
	69320	R69320E Valvula entra agua maquina hielo pro	Entrée d eau robinet pour 69320	Water inlet valve for 69320	16,60
	69320	R69320F Placa de control para maquina hielo pro	Panneau de controle para 69320	Control board for 69320	51,10
	69320	R69320G Compresor para maquina de hielos pro	Compresseur pour 69320	Compressor for 69320	130,45
	69320	R69320H Condensador maquina de hielo pro	Coupe pour 69320	Condensor for 69320	43,25
	69320	R69320J Ventilador para maquina de hielo pro	Ventilateur pour 69320	Fan for 69320	51,40
	69320	R69320K Pie goma para maquina de hielo pro	Pieds en coutchouc pour 69320	Ice cubes rubber feet for 69320	8,05
	69322	R69322D Magnetron horno microondas 69322	Microwave oven magnetron 69322	Microwave oven magnetron 69322	34,60
	69323	R69323A Plato cristal horno microondas d.315 mm.	Assiette verre four micro-ondes d. 270mm	Microwave oven glass dish d. 270 mm	14,35
	69323	R69323B Soporte grill horno microondas 23 lts.	Support grill pour micro-ondes 23 lts.	Grill rack for 23 lts. mcrowave oven	3,05
	69323	R69323C Guia giratoria+conector microondas 23	Guide giratorie+connecteur four micro-on	Round rail+connection part for mcrowave	2,25
	69323	R69323D Fusi+inter+motor p/gir+bombi 23/28/31	Fus+inter+moteur p/tour+ampomic 23/28/31	Fus+swit+motr rev/dish+ligh mic 23/28/31	10,50
	69323	R69323E Botonera+rueda giratoria mircoond. 23 l	Touches et commande pour 69323	Buttons and knob for 69323	9,55
	69323	R69323F Tirador+2 tornillos microond. 23 lts	Poignee+2 vis pour 69323	Handle+2 bolts for 69323	13,55
	69323	R69323G Placa de control microondas 23 lts	Plaque control pour 69323	Control card for 69323	15,55
	69323	R69323H Magnetron horno microondas 23 lts.	Microwave oven magnetron 23 lts	Microwave oven magnetron 23 lts	48,65
	69323	R69323J Transformador horno microondas 23 lts.	Micro-ondes transformateur 23 lts.	Microwave transformer 23 lts.	43,35
	69323	R69323K Ventilador horno microondas 23 lts	Micro-ondes ventilateur 23 lts.	Microwave fan 23 lts	17,80
	69323	R69323l Varios horno microondas 23 lts	Plusieurs micro-ondes 23 lts.	Several pieces mcrowave 23 lts	25,65
	69323	R69323M Mica para 69323	Mica pour 69323-28-30-31	Mica for 69323-28-30-31	0,50
	69323	R69323N Puerta microondas 23 lts	Porte pour micro-ondes 23 lts	Door for mcrowave 23 lts	28,20
	69323	R69323P Fusible 800ma para 69323-24-30	Fusible 800ma pour 69323-24-30	800ma fuse for 69323-24-30	5,10
	69323	R69323T Plato cristal horno microondas d.27 mm.	Assiette verre four micro-ondes d. 27mm	Microwave oven glass dish d.27 mm	7,55
	69323	R69323V Set 4 patas 69323	Définir quatre signaux pour 69323	Set four feeds for 69323	4,80





Ref.	Repuesto	Descripción	Description	Description	€
69324	R69324E	Botonera+rueda giratoria microond.25 l	Touches et commande pour 69324	Buttons and knob for 69324	12,50
69324	R69324F	Tirador+2 tornillos microond. 25 lts	Poignee+2 vis pour 69324	Handle+2 bolts for 69324	13,55
69324	R69324G	Placa de control microondas 25 lts	Plaque control pour 69324	Control card for 69324	45,90
69324	R69324I	Varios horno microondas 25 lts	Plusieurs micro-ondes 25 lts-69324	Several pieces microwave 25 lts-69324	48,55
69324	R69324N	Puerta horno microondas 25 lts	Porte pour micro-ondes 25 lts-69324	Door for microwave 25 lts-69324	34,00
69324	R69324P	Set 4 patas 69324	Définir quatre signaux pour 69324	Set four feeds for 69324	4,90
69325	R69325A	Set 4 pies de goma para 69325	1 ot des 4 caoutchouc pieds pour 69325	Set of 4 rubber feet for 69325	0,80
69325	R69325B	Tirador+ 2 tornillos microond 25 lts	Poignee+2 vis pour 69325	Handle+2 bolts for 69325	28,20
69325	R69325C	Termostato para microondas 69325	Thermostat pour micro-ondes 69325	Thermostat for microwave 69325	3,15
69325	R69325D	Bombilla luz interior para 69325	Ampoules lumière intérieur pour 69325	Internal bulb for 69325	1,55
69325	R69325E	Magnetron horno microondas 25 lts	Micro-ondes oven magnetron 25 lts	Microwave oven magnetron 25 lts	57,30
69325	R69325F	Transformador horno microondas 25 lts	Micro-ondes transformateur 25 lts	Microwave transformer 25 lts	60,05
69325	R69325G	Placa de control microondas 25 lts	Plaque control pour 69325	Control board for 69325	37,85
69325	R69325H	Botonera para microondas 25 lts	Touches et commande pour 69325	Control buttons for 69325	46,00
69326	R69326A	Pincho mariposa para horno 69326	Papillon brochette pour four 69326	Butterfly skewer for oven 69326	5,10
69328	R69323A	Plato cristal horno microondas d.315 mm.	Assiette verre four micro-ondes d. 270mm	Microwave oven glass dish d. 270 mm	14,35
69328	R69323C	Guia giratoria+conector microondas 23	Guide giratorie+connecteur four micro-on	Round rail+connection part for microwave	2,25
69328	R69323D	Fusi+inter+motor p/gir+bombi 23/28/31	Fus+inter+moteur p/tour+ampomic 23/28/31	Fus+swit+motr rev/dish+ligh mic 23/28/31	10,50
69328	R69328B	Soporte grill horno microondas 25-28-31l	Support grill four micro-ondes 28-31 lts	Grill rack for 28-31 lts. microwave oven	3,65
69328	R69328C	Guia giratoria+conect.microondas25-28-31	Guide giratorie+connecteur four micro-on	Round rail+connection part for microwave	2,25
69328	R69328E	Botonera+rueda giratoria microond.28 l	Touches et commande pour 69328	Buttons and knob for 69328	5,60
69328	R69328F	Tirador+2 tornillos microond. 28 lts	Poignee+2 vis pour 69328	Handle+2 bolts for 69328	6,70
69328	R69328G	Placa de control microondas 28 lts	Plaque control pour 69328	Control card for 69328	15,55
69328	R69328H	Magnetron horno microondas 28 lts.	Microwave oven magnetron 28 lts	Microwave oven magnetron 28 lts	43,25
69328	R69328J	Transformador horno microondas 28 lts.	Micro-ondes transformateur 28 lts.	Microwave transformer 28 lts.	45,60
69328	R69328K	Ventilador horno microondas 28 lts	Micro-ondes ventilateur 28 lts.	Microwave fan 28 lts	18,40
69328	R69328I	Varios horno microondas 28 lts	Plusieurs micro-ondes 28 lts.	Several pieces microwave 28 lts	69,50
69328	R69328N	Puerta microondas 28 lts	Porte pour micro-ondes 28 lts	Door for microwave 28 lts	32,15
69330	R69330A	Plato cristal horno microondas d.300 mm.	Assiette verre four micro-ondes d. 300mm	Microwave oven glass dish d.300 mm	17,30
69330	R69330B	Soporte grill horno microondas 30 lts	Grill rack micro-ondes 30 lts	Grill rack microwave 30 lts	3,15
69330	R69330C	Guia giratoria+conector microondas 30 lts	Guide giratorie+connecteur four micro-on	Round rail+connection part for microwave	2,35
69330	R69330D	Fusi+inter+motor p/gir+bombi 30 lts	Fus+inter+moteur p/tour+ampomic 30 lts	Fus+swit+motr rev/dish+ligh mic 30 lts	15,05
69330	R69330E	Botonera+rueda giratoria microond.30 l	Touches et commande pour 69330	Buttons and knob for 69330	17,30
69330	R69330F	Tirador+2 tornillos microond. 30 lts	Poignee+2 vis pour 69330	Handle+2 bolts for 69330	7,75
69330	R69330G	Placa de control microondas 30 lts	Plaque control pour 69330	Control card for 69330	47,00
69330	R69330H	Magnetron horno microondas 30 lts.	Microwave oven magnetron 30 lts	Microwave oven magnetron 30 lts	39,80
69330	R69330J	Transformador horno microondas 30 lts.	Micro-ondes transformateur 30 lts.	Microwave transformer 30 lts.	36,95
69330	R69330K	Ventilador horno microondas 30 lts	Micro-ondes ventilateur 31 lts.	Microwave fan 31 lts	13,95
69330	R69330I	Varios horno microondas 30 lts	Plusieurs micro-ondes 31 lts.	Several pieces microwave 31 lts	10,80
69330	R69330M	Set 4 patas 69330	Définir quatre signaux pour 69330	Set four feeds for 69330	4,60
69330	R69330N	Puerta horno microondas 30 lts	Porte micro-ondes 30 lts	Door microwave 30 lts	28,90
69331	R69323A	Plato cristal horno microondas d.315 mm.	Assiette verre four micro-ondes d. 270mm	Microwave oven glass dish d. 270 mm	14,35
69331	R69323C	Guia giratoria+conector microondas 23	Guide giratorie+connecteur four micro-on	Round rail+connection part for microwave	2,25
69331	R69323D	Fusi+inter+motor p/gir+bombi 23/28/31	Fus+inter+moteur p/tour+ampomic 23/28/31	Fus+swit+motr rev/dish+ligh mic 23/28/31	10,50
69331	R69328B	Soporte grill horno microondas 25-28-31l	Support grill four micro-ondes 28-31 lts	Grill rack for 28-31 lts. microwave oven	3,65
69331	R69328C	Guia giratoria+conect.microondas25-28-31	Guide giratorie+connecteur four micro-on	Round rail+connection part for microwave	2,25
69331	R69331E	Botonera+rueda giratoria microond.31 l	Touches et commande pour 69331	Buttons and knob for 69331	5,60
69331	R69331F	Tirador+2 tornillos microond. 31 lts	Poignee+2 vis pour 69331	Handle+2 bolts for 69331	4,60
69331	R69331H	Magnetron horno microondas 31 lts.	Microwave oven magnetron 31 lts	Microwave oven magnetron 31 lts	43,25
69331	R69331J	Transformador horno microondas 31 lts.	Micro-ondes transformateur 31 lts.	Microwave transformer 31 lts.	45,60
69331	R69331K	Ventilador horno microondas 31 lts	Micro-ondes ventilateur 31 lts.	Microwave fan 31 lts	18,40
69331	R69331I	Varios horno microondas 31 lts	Plusieurs micro-ondes 31 lts.	Several pieces microwave 31 lts	26,75
69331	R69331N	Puerta microondas 31 lts	Porte pour micro-ondes 31 lts	Door for microwave 31 lts	33,35
69332	R69332A	Placa control principal 69332-2000 w	Plaque pour controle cuisine induc.69332	Induction plaque main control board69332	44,05
69332	R69332B	Placa control botonera 69332-2000w	Plaque de contrôle utilisation 69332	Induction plaq.buttons control card69332	13,25
69332	R69332C	Ventilador placa induccion 69332	Ventilateur plaque à induction 69332	Induction plaque 69332 fan	4,50
69332	R69332D	Bobina placa induccion 69332-2000 w	Bobine pour plaque à induction 69332	Induction coil for plaque 69332-2000 w	17,60
69332	R69332I	Cable conexion placa induccion 69332	Câble connexion plaque à induction 69332	Induction plaque 69332 power cord	8,85
69333	R69333A	Bobina 2000w	Bobine chauffage arriere 2000w	Heating coil 2000w	24,60
69333	R69333B	Bobina 1500w	Bobine chauffage arriere 1500w	Heating coil 1500w	24,60
69333	R69333C	Placa control izquierda para 69333	Pcb controle gauche pour 69333	Left control pcb for 69333	56,05
69333	R69333D	Placa control derecha para 69333	Pcb controle droite pour 69333	Right control pcb for 69333	56,05
69333	R69333E	Ventilador para 69333	Ventilateur pour 69333	Fan for 69333	5,50
69333	R69333F	Panel de control tactil izquierdo 69333	Tableau contrôle gauche pour 69333	Left induction plate control panel 69333	17,30
69333	R69333G	Panel de control tactil derecho 69333	Tableau contrôle droit pour 69333	Right induction plate contro panel 69333	17,30
69333	R69333H	Set 4 pies de goma para 69333	Set 4 pieds pour 69333	4 rubber feet set for 69333	5,60
69333	R69333J	Placa cristal induccion 69333	Plaque de verre pour 69333	Induction glass plate for 69333	75,40
69333	R69333K	Sensor de temperatura izquier para 69333	Capteur de temperature gauche pour 69333	Left temperature sensor for 69333	5,10
69333	R69333I	Sensor de temperatura derecho para 69333	Capteur de temperature droit pour 69333	Right temperature sensor for 69333	5,10
69335	R69335A	Espatula + cazo + vaso para 69335	Spatule + seau + verre pour 69335	Spatula + bucket + glass for 69335	2,05
69335	R69335B	Bandeja de vapor para olla elect. 69335	Plateau a vapeur pour 69335	Steam tray for 69335 cooker	1,30
69335	R69335C	Cubeta interior para olla elect. 69335	Pot interieur pour 69335	Inner pot for cooker 69335	24,30
69335	R69335D	Cestillo freidora para olla elect. 69335	Panier a friture pour 69335	Frying basket for cooker 69335	8,15





Ref.	Repuesto	Descripción	Description	Description	€
69335	R69335E	Accesorios yogurt para olla elect. 69335	Accessoires yogurt pour 69335	Inner pot for cooker 69335	8,15
69335	R69335F	Tapon salida de vapor para 69335	Bouchonfour a vapeur pour 69335	Cap for stean outlet for 69335	2,05
69335	R69335G	Junta silicona para 69335	Joint de silicone pour 69335	Silicon gasket for 69335	2,05
69335	R69335H	Panel de control para olla elect. 69335	Panneau de controle pour 69335	Control panel for cooker 69335	8,15
69335	R69335I	Recetario olla electrica programable 5lt	livre recettes cuisiniere elect.progr.5l	Recipe book programmable cooking pot 5 l	15,85
	69337	R69337A Placa control principal 69337-2700 w	Plaque pour controle cuisine induc.69337	Induction plaque main control board69337	88,10
69337	R69337B	Placa control botonera 69337-2700w	Plaque de contrôle utilisation 69337	Induction plaq.buttons control card69337	15,45
69337	R69337C	Ventilador placa induccion 69337	Ventilateur plaque à induction 69337	Induction plaque 69337 fan	6,60
69337	R69337D	Bobina placa induccion 69337-2700 w	Bobine pour plaque à induction 69337	Induction coil for plaque 69337-2700 w	22,10
69337	R69337G	Pie goma placa induccion 69337-2700 w	Pie caught.pour plaque à induction 69337	Induction plaque 69337-2700w rubber feet	1,00
69337	R69337I	Cable conexion placa induccion 69337	Câble connexion plaque à induction 69337	Induction plaque 69337 power cord	15,45
	69342	R69342A Pincho mariposa para 69342	Papillon brochette pour 69342	Butterfly skewer for 69342	5,60
69342	R69342B	Pinza para bandeja de 69342	Pince pour plateau do 69342	Tray tong for 69342	1,20
69342	R69342C	Mango para picho mariposa de 69342	Poignee papillon brochette pour 69342	Handel of butterfly skewer for 69342	1,20
69342	R69342D	Parrilla para 69342	Grille pour 69342	Wire rack for 69342	2,15
69342	R69342E	Bandeja de horneado para 69342	Plateau cuire pour 69342	Bake tray for 69342	5,40
69342	R69342F	Set 4 patas para 69342	Jeu de 4 pieds pour 69342	Set of 4 feet for 69342	1,10
69342	R69342G	Mando conveccion-asador para 69342	Rotisserie et convection bouton 69342	Rotisserie and convection knob 69342	3,35
69342	R69342H	Termostato para 69342	Thermostat pour 69342	Thermostat for 69342	3,65
69342	R69342J	Interruptor de calentamiento para 69342	Commutateur de chauffage 69342	Heater switch for 69342	3,35
69342	R69342K	Temporizador para 69342	Minuteur pour 69342	Timer for 69342	3,35
69342	R69342M	Resistencia airpot electrico 5,2l	Resistance chauffante pour 69475	Heating resistance for 69475	14,85
69342	R69342P	Resistencia horno electrico 450w	450w resistance chauffante pour 69475	450w heating resistance for 69475	14,25
69342	R69342Q	Motor horno electrico 450w	450w moteur pour four 69475	450w engine for oven 69475	14,25
	69349	R69349A Mango crepra 69349	Poigne gaufrier électrique 69349	Handle for waffle maker 69349	23,00
69349	R69349B	Resistencia superior crepra 69349	Resistance superieure 69349	Upper heating resistance for 69349	26,25
69349	R69349C	Resistencia inferior crepra 69349	Resistance inferieure 69349	Base heating resistance for 69349	26,25
69349	R69349D	Set 2 patas de goma para 69349	En caoutchouc pour 69349	2 rubber feet set for 69349	4,60
69349	R69349E	Temporizador para 69349	Minuteur pour 69349	Timer for 69349	5,30
69349	R69349F	Regulador de temperatura para 69349	Regulateur de chauffage pour 69349	Heat regulator for 69349	19,25
69349	R69349G	Indicadores de encendido/calentam. 69349	Chaileur/puissance indicateur pour 69349	Heat and power indicators for 69349	21,55
	69350	R69350F Placa control botonera 69350	Panneau commande bouton pour 69350	Button pboard for maxi vacuum machine	42,35
69350	R69350G	Tubo neumatico maquina vacio maxi	Tube pneumatique pour 69350	Pneumatic tube for 69350	5,30
69350	R69350H	Hilo de sellado maquina vacio maxi 110 w	Cabler etancheite souds visde maxi 110 w	Welding wire for110w maxi vacuum machine	7,65
69351	R69351A	Almoadilla + junta de sellado 69351	Coussinet + phoque	Up and down foam + seal gasket	4,25
69351	R69351B	Boton apertura tapa + interruptor	Bouton de deverrouillage	Air release button	4,25
69351	R69351C	Patas de goma	Pieds en caoutchouc	Rubber feet	4,25
69351	R69351D	Set de sellado	Ensemble d etancheite	Sealing set	4,80
69351	R69351E	Placa electronia de control	Carte principale electronique	Up and down foam + seal gasket	41,90
69351	R69351F	Motor de vacio	Moteur de vacuo	Motor pump	10,70
69351	R69351G	Tubo neumatico	Tube pneumatique	Pneumatic tube	4,25
69352	R69352A	Barra de sellado maquina vacio 69116	Barre de soudure machine a vide 69352	Sealing bar for vacuum machine 69352	13,45
69352	R69352B	Cuchilla de corte bolsa 69352	ame de coupe sac pour 69352	Bag cutting blade for 69352	4,70
69352	R69352E	Placa de control maquina vacio 69352	Carte principale machine a vide 69352	Pboard for vacuum machine 69352	128,80
69352	R69352G	Bomba de succion para 69352	Pompe aspirante pour 69352	Suction pump for 69352	37,05
69352	R69352K	Almohadil de sellado maquina vacio 69352	Tampon de soudure machine a vide 69352	Sealing pad for vacuum machine 69352	4,90
69352	R69352M	Almohadilla vacio superior para 69352	Coussin vide superieur machine 69352	Upper foam for 69352 vacuum machine	15,95
69352	R69352N	Tapa transparente para 69352	Couvercle transparent machine 69352	Transparent lid for 69352 vacuum machine	122,30
	69355	R69355A Panel de mandos para 69355	Panneau de commande pour 69355	Control panel for 69355	8,35
69355	R69355B	Pies de goma + conte. l iquidos 69355	Pieds caoutchouc + recipient a liquide	Rubber feet + liquid container 69355	4,60
69355	R69355C	Placa electronica para 69355	Carte principale pour 69355	Main board for 69355	31,45
69355	R69355D	Bomba succion maquina 69355	Pompe de succion pour 69355	69355 vacuum machine suction pump	7,95
69355	R69355E	Conjunto de sellado superior 69355	Esemble d etancheite superieur 69355	Upper sealing body 69355	5,10
69355	R69355F	Conjunto de sellado inferior 69355	Esemble d etancheite inferieur 69355	ower sealing body 69355	5,10
69355	R69355G	Pulsador lateral izquierdo 69355	Bouton ouverture gauche 69355	left side open/close button 69355	4,80
69355	R69355H	Pulsador lateral derecho 69355	Bouton ouverture droit 69355	Right side open/close button 69355	4,80
69363	R69363A	Bandeja recogemigas tostadora "pro" 600w	Plateau ramasse-miettes grille "pro"600w	Crumbs tray flat toaster "pro" 600 w	4,40
69363	R69363B	Pies de goma tostadora horizon."pro"600w	Pied en caoutchouc grille horiz."pro"600	4 pcs rubber feet flat toaster "pro"600w	4,40
69363	R69363C	Temporizador tostadora horizon."pro"600w	Commande temporisa.grille horiz."pro"600	Timer control for flat toaster "pro"600w	4,40
	69368	R69368A Bandeja alum.picadora de carne pro 250 w	Plateau hachoir électriq.viande pro250w	Meat mincer pro 250 w, aluminium tray	22,20
69368	R69368B	Tubo t alum. picadora de carne pro 250 w	T tube hachoir électriq.viande pro250w	Meat mincer pro 250w,alum.cutting t tube	21,35
69368	R69368C	Husillo picadora de carne pro 250 w	Broche hachoir électrique viande pro250w	Meat mincer pro 250 w, helix	14,95
69368	R69368D	Empujador picadora de carne pro 250 w	Pousseur électrique pour viande pro 250w	Meat mincer pro 250w,polyethylen pusher	4,40
69368	R69368E	Tuerca alum.picadora de carne pro 250w	Écrou alum.hachoir élect.viande pro250w	Meat mincer pro 250w,aluminium nut	23,90
69368	R69368F	Cuchilla picadora de carne pro 250 w	ame hachoir électrique viande pro250w	Meat mincer pro 250 w,spare blade	8,65
69368	R69368G	Disco grueso picadora de carne pro 250 w	Disque épai.hachoir élect.viande pro250w	Meat mincer pro250w,coarse grinding disk	6,40
69368	R69368H	Disco medio picadora de carne pro 250 w	Disque méd.hachoir élect.viande pro250w	Meat mincer pro250w,medium grinding disk	6,40
69368	R69368J	Disco fino picadora de carne pro 250 w	Disque fine hachoir élect.viande pro250w	Meat mincer pro 250w,fine grinding disk	6,40
69368	R69368K	Pomo fijacion picadora de carne pro 250w	Bouton hachoir électriq.viande pro250w	Meat mincer pro 250w, locking knob	4,40



Ref.	Repuesto	Descripción	Description	Description	€
69368	R69368I	Pies goma 2pc picadora de carne pro 250w	Pied caoutc.hachoir élect.viande pro250w	Meat mincer pro 250w,rubber feet 2 pcs	4,70
69368	R69368M	Interruptor picadora de carne pro 250w	Commutat.hachoir électriq.viande pro250w	Meat mincer pro 250w, on-off switch	12,80
69368	R69368N	Capacitador picadora de carne pro 250w	Commutateur hachoir élect.viande pro250w	Meat mincer pro 250w, commutator	4,40
69368	R69368P	Motor picadora de carne pro 250 w	Moteur hachoir élect.viande pro250w	Meat mincer pro 250w, motor	170,45
69368	R69368Q	Engranaje reverse picadora carne 69368	Reverse engrenage hachoir élect. 69368	Reverse gear, meat mincer pro 250w	27,80
69368	R69368R	Accesorios para salchichas para 69368	Accessoires de saucisses para 69368	Sausage accessories for 69368	9,35
	69369	R69369A Bandeja picadora electrica de carne	Plateau hachoir électrique pour viande	Food tray for meat grinder	11,40
69369	R69369B	Empujador para 69369	Pousseur pour 69369	Meat grinder pusher for 69369	5,30
69369	R69369C	Tuerca picadora electrica de carne	Écrou hachoir électrique pour viande	Meat grinder nut	5,30
69369	R69369D	Llave de bloqueo para 69369	Cle le blocage pour 69369	Lock key for 69369	4,80
69369	R69369E	Disco fino picadora electrica de carne	Disque fine hachoir élec.pour viande	Meat grinder fine grinding disk	5,90
69369	R69369F	Disco mediano picadora elec. de carne	Disque médium hachoir élec.pour viande	Meat grinder medium grinding disk	5,90
69369	R69369G	Disco grueso picadora electrica de carne	Disque épaisse hachoir élec. pour viande	Meat grinder coarse grinding disk	5,90
69369	R69369J	Cuchilla picadora electrica de carne	Lame hachoir électrique pour viande	Meat grinder blade	5,50
69369	R69369K	Accesorios para salchichas para 69369	Accessoires de saucisses para 69369	Sausage accessories for 69369	9,35
69369	R69369I	Husillo picadora electrica de carne	Broche hachoir électrique pour viande	Meat grinder helix	8,45
69369	R69369M	Tubo t alum. picadora de carne 69369	T tube hachoir électriq.viande 69369	Meat mincer 69369,alum.cutting t tube	16,80
69369	R69369N	Pies goma 4pc picadora de carne 69369	Pied caoutc.hachoir élect.viande 69369	Meat mincer 69369,rubber feet 4 pcs	4,80
69369	R69369P	Motor picadora de carne 69369	Moteur hachoir élect.viande 69369	Meat mincer 69369, motor	28,90
69369	R69369Q	Set de engranajes para 69068	Set vitesse pour 69369	Gear set for grinder 69369	8,45
69369	R69369R	Eje motor para 69369	Axe du moteur para 69369	Motor axis for 69369	4,80
69369	R69369T	Interruptor picadora de carne 69369	Commutat.hachoir électriq.viande 69369	Meat mincer 69369, on-off switch	5,30
	69370	R69370A Tapa para 69370	Couvercle pour 69370	Lid for 69370	4,60
69370	R69370B	Empujador para 69370	Poussoir pour 69370	Pusher for 69370	4,60
69370	R69370C	Cuchilla flor para 69370	Fleur lame pour 69370	Flower blade for 69370	4,60
69370	R69370D	Cuchilla spirelli fino para 69370	Fine spiral lame pour 69370	Fine spiral blade for 69370	4,60
69370	R69370E	Cuchilla spirelli gruesa para 69370	Grossier spiral lame pour 69370	Coarse spiral blade for 69370	4,60
69370	R69370F	Contenedor de alimento para 69370	Recipient pour aliments pour 69370	Food container for 69370	4,80
69370	R69370G	Set 5 pies de goma para 69370	Set 5 pieds en caoutchouc pour 69370	5 pcs rubberfeet set for 69370	4,05
	69372	R69372A Filtro exprimidor lento 200 w	Filtre pour presse-agrumes lent 200 w	Filter for 200 w slow juicer	14,15
69372	R69372B	Contenedor zumo/desecho para 69372	Conteneur jus et dechets pour 69372	Juice and waste container for 69372	12,00
69372	R69372C	Compartimento zumo exprim. lento 200 w	Contenant de jus presse-agrumes lent	Juice container for 200 w slow juicer	24,00
69372	R69372D	Empujador exprimidor lento 200 w	Poussoir plastique presse-agrumes lent	Plastic pusher for 200 w slow juicer	3,25
69372	R69372E	Tubo + bandeja exprimidor lento 200 w	Tube + plateau presse-agrumes lent 200 w	Tube + tray for 200 w slow juicer	18,50
69372	R69372F	2 cepillos limpiadores para 69372	Nettoyants brosses pour 69372	2 cleaning brush 200 w slow juicer	1,95
69372	R69372G	Presor para exprimidor lento 200 w	Presseur pour presse-agrumes lent 200 w	Presser for 200 w slow juicer	27,25
69372	R69372H	Accesorio papilla exprimidor lento 200 w	Boullie accessoire presse-agrumes lent	Pap accessory for 200 w slow juicer	9,25
69372	R69372J	Set 4 pies gomea exprimidor lento 200 w	Set 4 pieds presse-agrumes lent 200 w	Set of 4 rubber feet 200 w slow juicer	1,10
69372	R69372N	Interruptor on/off 69372	Interrupteur on/off 69372	69372 on/off switch	5,10
	69373	R69373A Filtro exprimidor lento alto 240w	Filtre presse-agrumes lent haute 240w	Tall slow juicer 240 w filter set	34,10
69373	R69373B	Jarra exprimidor lento alto 240 w	Conteneur presse-agrumes lent haute 240w	Tall slow juicer 240 w spare jug	5,10
69373	R69373C	Cabezal sup.exprimidor lento alto 240w	Contenant presse-agrumes lent haute 240w	Tall slow juicer 240 w upper block	17,10
69373	R69373D	Empujador exprimidor lento alto 240 w	Poussoir presse-agrumes lent haute 240w	Tall slow juicer 240 w pusher	4,40
69373	R69373E	Tubo superior exprimidor lento alto 240w	Tube supe.presse-agrumes lent haute 240w	Tall slow juicer 240 w upper tube	14,95
69373	R69373F	Juego siliconas exprimid.lento alto 240w	Silicones presse-agrumes lent haute 240w	Tall slow juicer 240 w silicone gaskets	4,40
69373	R69373G	Hélice prens.exprimidor lento alto 240w	Presseur presse-agrumes lent haute 240w	Tall slow juicer 240 w press screw	85,25
69373	R69373H	Interruptor exprimidor lento alto 240w	Commutate.presse-agrumes lent haute 240w	Tall slow juicer 240 w on-off switch	4,40
69373	R69373J	Pies de goma exprimidor lento alto 240w	Set pieds presse-agrumes lent haute 240w	Tall slow juicer 240 w rubber feets	4,40
69373	R69373K	Micro segurid.exprimidor lento alto 240w	Commut.se.presse-agrumes lent haute 240w	Tall slow juicer 240 w security switch	4,40
69373	R69373L	Recetario exprimidor lento alto 240 w	livre recettes presse-agrumes lent haute	Recipe book tall slow juicer 240 w	8,45
69373	R69373M	Accesorio frozen fruit 69373	Accessoire frozen fruit 69373	Frozen fruit accessory for 69373	15,35
69373	R69373N	Cepillo limpiador para 69373	Nettoyant brosse pour 69373	Cleaning brush slow juicer 69373	6,30
69380	R69380J	Conector embrague motor 69380	Arbre embrayage pour 69380	Motor axis clutch for 69380	8,15
69380	R69380K	Tapa nueva para batidora de sopa	Nouveau haut soupe machine 1,7 lts 1350w	New lid for soup maker 1,7 lts 1350w	19,35
69380	R69380N	Base completa nueva batidora sopa 1,7 l	Nouveau base soupe machine 1,7 lts 1350w	New base for soup maker 1,7 lts 1350w	113,45
69380	R69380P	Nueva jarra para batidora de sopa	Nouveau haut soupe machine 1,7 lts 1350w	New jar for soup maker 1,7 lts 1350w	15,15
69380	R69380Q	Nueva panel control batidora sopa 1,7 l	Nouveau panneau commande soupe machine	New control panel for soup maker 1,7 l	25,05
69380	R69380R	Nuevo conector embrague motor 69380	Nouveau arbre embrayage pour 69380	New motor axis clutch for 69380	7,65
	69381	R69381A Conjunto cuchilla para 69381	Lame pour 69381	Blade set for 69381	5,30
69381	R69381B	Botella + tapon para 69381	Bouteille avec couvercle pour 69381	Bottle with lid for 69381	8,45
69381	R69381C	Pies de goma para 69381	Pieds en caoutchouc pour 69381	Rubber feet for 69381	4,50
69381	R69381D	Embrague motor para 69381	Embrayage du moteur pour 69381	Motor clutch for 69381	4,50
69382	R69382A	Conjunto cuchilla para 69382	Lame pour 69382	Blade set for 69382	5,30
69382	R69382B	Botella + tapon 600 ml para 69382	Bouteille couvercle pour 600 ml 69382	Bottle with lid 600 ml for 69382	5,30
69382	R69382C	Pies de goma para 69382	Pieds en caoutchouc pour 69382	Rubber feet for 69382	4,25
69382	R69382D	Embrague motor para 69382	Embrayage du moteur pour 69382	Motor clutch for 69382	4,25
69382	R69382E	Botella 300 ml para 69382	Bouteille avec couvercle 300ml 69382	Bottle with lid 300ml for 69382	5,30
69382	R69382F	Funda neopreno para 69382	Manchon neoprene pour 69382	Neoprene sleeve for 69382	2,45
69384	R69384A	Juego de varillas batidoras para 69384	Jeu de 2 batteurs pour 69384	St.steel beaters hooks set for 69384	1,00
69384	R69384B	Juego de varillas amasadoras para 69384	Jeu de 2 malaxeurs pour 69384	St.steel dough hooks set for 69384	1,00
	69388	R69388A Bol de acero inoxidable para 69388	Bol en acier inoxydable pour 69388	Stainless steel bowl for 69388	22,40
69388	R69388B	Protector anti-salpicaduras para 69388	Éclaboussure protecteur pour 69388	Splash protector for 69388	5,10
69388	R69388C	Varilla mezcladora batidora-amas. 69388	Fouet mélangeur mixeur pétriss. 69388	Mixer rod blender-kneader 69388	10,80

Ref.	Repuesto	Descripción	Description	Description	€	
69388	R69388D	Varilla batidor batidora-amasadora 69388	Fouet batteur mixeur-pétrisseur 69388	Rod blender blender-kneader 69388	5,40	
69388	R69388E	Varilla amasadora batidora-amas. 69388	Fouet pétrisseur mixeur pétriss. 69388	Kneader blender rod kneader 69388	10,40	
69388	R69388F	Set 4 patas silicona para 69388	Set 4 pieds de silicone pour 69388	4 rubber feet set for 69388	4,05	
69388	R69388G	Pomo regulador velocidad + led 69388	Bouton commande vitesse + led 69388	Speed control knob + led for 69388	6,70	
69388	R69388H	Placa control batidora amasadora 69388	Tableau commande principal para 69388	Main control board for 69388	20,55	
69388	R69388J	Caja de engranajes para 69388	Engrenage set pour 69388	Gear box for 69388	6,60	
69388	R69388K	Eje central + engranajes para 69388	Axe central + engrènement pour 69388	Central axis + gears for 69388	9,05	
69388	R69388L	Engranaje principal para 69388	Engrenage principal pour 69388	Main gear for 69388	7,95	
69388	R69388M	Correa transmisión para 69388	Courroie transmission pour 69388	69388 transmission belt	6,10	
69388	R69388N	Eje + rodamiento para 69388	Axe + bande de roulement pour 69388	Central + bearing for 69388	10,20	
69388	R69388P	Motor para 69388	Moteur pour 69388	Motor for 69388	37,05	
69396	R69396A	Tapa + accesorios batidores para 69396	Couvercle + batteurs pour 69396	lid + beaters for 69396	5,10	
69396	R69396B	Base calentamiento para 69396	Base chauffante pour 69396	Heating base for 69396	13,45	
	69400	R69400A	Mesa calentador terraza a gas d.40 cm	Tableau pour chauffage de terrasse d.40cm	Outdoor gas heater round table d.40 cm	30,30
	69400	R69400B	Jgo ruedas blancas inox calentad.terraza	Ensemble de roves por chauffage blanc	Outdoor gas heater st steel white wheels	8,55
	69400	R69400C	Casquillos acople mesa calentador terraz	Écrou assemb. plast. table chauffage gaz	Outdoor gas heater table assem.plast.nut	7,75
	69400	R69400D	Jgo tornillos calentador terraza a gas	Kit de montage pour chauffage ext.à gaz	Outdoor gas heater fastener assembly set	10,60
	69400	R69400G	Valvula control gas calentador terraza	Contrôleur soupape à gaz chauffage ext.g	Outdoor gas heater gas valve controler	31,65
	69400	R69400H	Piecelectrico calentador terraza a gas	Kit d_allumage chauffage ext.à gaz	Outdoor gas heater igniter set	6,40
	69400	R69400J	Cabezal quemador calentador terraza gas	Tête de combustion chauffage ext.à gaz	Outdoor gas heater burning head	146,70
	69400	R69400I	Cubre bombona inox calentadorterraza gas	Boîtier réservoir à gaz inox chauff.ext.	Outdoor gas heater st st gas tank housin	113,35
	69400	R69400M	Pata soporte calentador terraza gas	Pied support chauffage extérieur à gaz	Outdoor gas heater support leg	25,65
	69400	R69400N	Cubre calentador terraza a gas pe	Housse pour chauffage terrasse à gaz	Outdoor gas heater pe full cover	13,45
	69400	R69400Q	Válvula agitadora calentador terraza gas	Interrupt.décharge chauffage extér.à gaz	Outdoor gas heater dump switch	6,70
	69400	R69400R	Jgo ruedas negras acero calentad.terraza	Ensemble de roves por chauffage noir	Outdoor gas heater iron black wheels	8,55
	69400	R69400S	Cables calentador terraza gas	Câbles de connexion chauffage ext.gaz	Outdoor gas heater connection wires	10,60
	69400	R69400TE	Tubo gas para españa	Tube de gaz pour l'espagne	Tube of gas for spain	6,40
	69400	R69400TF	Tubo gas para francia	Tube de gaz de france	Tube of gas for france	6,40
	69400	R69400TP	Tubo gas para portugal	Tube de gaz pour le portugal	Tube of gas for portugal	6,40
69400	R69400U	Rejilla circular calentador a gas	Rack de chauffage gaz	Gas heater grid	33,35	
69400	R69400Z	Cabezal quemador calentador terraza new	Tête de combustion chauffage ext new	Newoutdoor gas heater burning head	146,70	
	69401	R69400A	Mesa calentador terraza a gas d.40 cm	Tableau pour chauffage de terrasse d.40cm	Outdoor gas heater round table d.40 cm	30,30
	69401	R69400B	Jgo ruedas blancas inox calentad.terraza	Ensemble de roves por chauffage blanc	Outdoor gas heater st steel white wheels	8,55
	69401	R69400C	Casquillos acople mesa calentador terraz	Écrou assemb. plast. table chauffage gaz	Outdoor gas heater table assem.plast.nut	7,75
	69401	R69400D	Jgo tornillos calentador terraza a gas	Kit de montage pour chauffage ext.à gaz	Outdoor gas heater fastener assembly set	10,60
	69401	R69400G	Valvula control gas calentador terraza	Contrôleur soupape à gaz chauffage ext.g	Outdoor gas heater gas valve controler	31,65
	69401	R69400H	Piecelectrico calentador terraza a gas	Kit d_allumage chauffage ext.à gaz	Outdoor gas heater igniter set	6,40
	69401	R69400J	Cabezal quemador calentador terraza gas	Tête de combustion chauffage ext.à gaz	Outdoor gas heater burning head	146,70
	69401	R69400K	Cubre bombona negro calentad.terraza gas	Boîtier réservoir à gaz noir chauff.ext.	Outdoor gas heater black gas tank housin	63,40
	69401	R69400M	Pata soporte calentador terraza gas	Pied support chauffage extérieur à gaz	Outdoor gas heater support leg	25,65
	69401	R69400N	Cubre calentador terraza a gas pe	Housse pour chauffage terrasse à gaz	Outdoor gas heater pe full cover	13,45
	69401	R69400Q	Válvula agitadora calentador terraza gas	Interrupt.décharge chauffage extér.à gaz	Outdoor gas heater dump switch	6,70
	69401	R69400R	Jgo ruedas negras acero calentad.terraza	Ensemble de roves por chauffage noir	Outdoor gas heater iron black wheels	8,55
	69401	R69400S	Cables calentador terraza gas	Câbles de connexion chauffage ext.gaz	Outdoor gas heater connection wires	10,60
	69401	R69400TE	Tubo gas para españa	Tube de gaz pour l'espagne	Tube of gas for spain	6,40
	69401	R69400TF	Tubo gas para francia	Tube de gaz de france	Tube of gas for france	6,40
	69401	R69400TP	Tubo gas para portugal	Tube de gaz pour le portugal	Tube of gas for portugal	6,40
	69410	R69410A	l ampara pequeña+grande 69410-21	Petit+gross lampe pour 69410-21	Small+large lamp for 69410-21	24,40
	69410	R69410C	Base+protector+tubos+tornillos 69410-1	Base+ protecteur+vis pour 69410	Base+protector+screws for 69410	60,65
	69410	R69410E	Cenicero para calentador eléctrico pie	Cendrier pour rechauff.électrique pied	Ashtray for electric heating lamppost	20,05
	69410	R69410F	Mesa para calentador electrico pie d.60	Table rond rechauff.électrique pied d.60	Round table for electric heat.lamppost60	50,05
	69410	R69410H	Tuerca para control de altura calentador	Écrou pour chauffe commande de hauteur	Nut for heater height control	2,15
	69410	R69410J	Carcasa del interruptor para 69410	Support del interrupteur pour 69410	Switch cover for 69410	4,40
69411	R69411A	l ampara peq. para 69411	Petit lampe pour 69411	Small lamp for 69411	28,40	
69411	R69411B	l ampara grande para 69411	Grand lampe pour 69411	Big lamp for 69411	34,30	
	69412	R69412A	Parte superior calentador pie 2000w	Parte superioe resistance électrique	Top part of electric heater 69412	170,35
	69412	R69412B	Parte inferior calentador electrico pie	Chauffe-bas pour 69412	Bottom part of 69412	155,70
	69412	R69412C	Base para calentador electrico pie 2000w	Base de chauffage pour 69412	Heater base for 69412	64,00
	69412	R69412E	Resistencia calentamiento para 69412	Element chauffant pour 69412	Heating element for 69412	48,85
	69413	R69413A	Mesa para calentador 69413	Tableau pour chauffage 69413	Table for 69413 heater	47,70
	69413	R69413B	Base para calentador 69413	Base pour chauffage 69413	Base for 69413 heater	76,70
	69413	R69413C	Resistencia para calentador 69413	l ampe chauffage pour chauffage 69413	Heating lamp for 69413 heater	64,00
	69413	R69413D	Interruptor on/off para calentador 69413	On/off interrupteur pour chauffage 69413	On/off switch for 69413 heater	4,40
69417	R69417A	Tapa calentador liquidos summit 12 lts	Couvercle summit chauffe-café 12 lts	lid for summit coffee urn 12 lts	43,75	
69417	R69417B	Cuerpo calent liquid summit sin grifo	Marmite sans tap summit chauffe-café	Body summit coffee urn w/o faucet	131,85	
69417	R69417C	Grifo calentad. liquid. inox summit 12 l	Robinet pour summit chauffe-café inox	Faucet for summit coffee urn inox	30,10	
69418	R69418B	Urna acrilica de zumo para 69418	Jus acrylique urne pour 69418	Acrylic juice urn for 69418	131,85	
69418	R69418D	Tubo enfriador inox para 69418	Inox tube de refroidissement para 69418	Stainless steel cooling tube for 69418	16,90	



Ref.	Repuesto	Descripción	Description	Description	€
	69420	R69420A 1 ampara peq. para 69420	Petit lampe pour 69420	Small lamp for 69420	0,00
	69420	R69420C Interruptor con cuerda calentador 69420	Interrup avec corde pour chafee 69420	Switch with rope for heater 69420	32,25
					8,65
	69421	R69421A Soporte pared para 69421	Support de mur pour 69421	Wall support for 69421	38,95
	69421	R69421B 1 ampara peq. para 69421	Petit lampe pour 69421	Small lamp for 69421	24,40
	69421	R69421D Switch para 69421	Contacteur pour 69421	Switch for 69421	7,35
	69421	R69421E Carcasa del interruptor para 69421	Support del interrupteur pour 69421	Switch cover for 69421	6,90
					0,00
					0,00
	69423	R69423A Soporte pared para 69423	Support de mur pour 69423	Wall support for 69423	38,95
	69423	R69423B Cadena colgante para 69423	Chaîne hang pour 69423	Chain hang for 69423	14,45
	69423	R69423C Soporte vertical lámpara eléctrica 69423	Pied de soutien pour 69423	Vertical support for 69423	89,05
	69423	R69423D Pieza giratoria brazo para 69423	Pièce rotative pour 69423	Rotating piece for 69423	10,70
	69423	R69423E Switch para 69423	Basculez pour 69423	Switch for 69423	7,35
	69423	R69423F Switch pequeño para 69423	Petit commutateur pour 69423	Small switch for 69423	4,25
	69423	R69423G 1 ampara 650w para 69423	1 ampe 650w pour 69423	650w lamp for 69423	16,20
					0,00
	69424	R69424A Soporte pared para 69424	Support de mur pour 69424	Wall support for 69424	20,55
	69424	R69424B Control remoto para 69424	Télécommande pour 69424	Remote control for 69424	18,10
	69424	R69424C 1 ampara para 69424	1 ampe pour 69424	1 amp for 69424	28,40
	69424	R69424D Switch para 69424	Basculez vers 69424	Switch for 69424	10,70
	69424	R69424E 1 ampara de led	1 ed lampe	1 ed lamp	16,40
	69424	R69424F Placa electronica de control para 69424	Plaque control pour 69424	Pcboard for 69424	20,15
	69424	R69424G 1 ampara de led v2	1 ed lampe v2	1 ed lamp v2	18,50
	69430	R69430K Boton lateral máquina de vacio pro	Couvercle bouton d ouverture-fermeture	1 id open-close button	7,65
	69430	R69430I Electrovalvula para 69430	Electrovalvula pour 69430	Electrovalve for 69430	68,15
	69430	R69430M Placa electronica para 69430	Tableau controle electronique pour 69430	Electronic control board for 69430	242,90
	69430	R69430N Bomba de succión para 69430	Pompe de air pour 69430	Air pump for 69430	142,05
	69473	R69473A Placa de control airpot electrico 3.5 l	Plaque control pour 69473	Control card for 69473	7,65
	69473	R69473B Base giratoria airpot electrico 3.5 l	Base pivotante pour 69473	Rotating base for 69473	2,05
	69473	R69473C Tapa completa para airpot electrico 3,5l	Couverture pour 69473	1 id for 69473	13,95
	69473	R69473D Asa para airpot electrico 3,5/4,5 l	3,5/4,5 l électrique airpot anje	Handle for electric air pot 3,5/4,5 l	1,20
	69473	R69473E Panel de control par airpot 3,5/4,5 l	Plaque control élect. airpot 3,5/4,5 l	Control panel for elec. airpot 3,5/4,5l	4,90
	69473	R69473F Cable potencia airpot elect. 3,5/4,5 l	Câble puissance elect. airpot 3,5/4,5 l	Power cord for elect. airpot 3,5/4,5 l	5,40
	69475	R69475F Asa lateral airpot 5.2 l	Poignée laterale pour 69475	Side handle for 69475	5,30
	69493	R69493A Cubeta sous vide multifuncion 6 lts	Panier multif.électr.sous vide 6 lts	Non-stick container multif.sous vide 6lt	47,20
	69493	R69493B Soporte sous vide multifuncion 6lt 1500w	Socle inox multif.électr.sous vide 6 lts	St stand multifuncion sous vide 6l 1500w	15,95
	69493	R69493D Rejillas sous vide multifuncion (2 pcs)	Grille multif.électr.sous vide 6 lts (2)	St racks multifunt.sous vide (2 pcs)	32,65
	69493	R69493E Tapa cristal sous vide multifuncion 6l	Couvercle multif.électr.sous vide 6 lts	Glass lid multifunt.sous vide 6l 1500w	17,80
	69493	R69493F Pies goma 4 sous vide multifuncion 6 lts	Pieds caoutchouc multif.élec.sous vide	Rubber feet 4 pcs multifun.sous vide 6lt	4,40
	69493	R69493G Panel frontal sous vide multifuncion	Panneau frontal multif.élec.sous vide	Front panel multifun.sous vide 6lt 1500w	52,10
	69493	R69493i Recetario sous vide multifuncion 6lt	1 livre recettes cuisiniere sous vide mult	Recipe book multifunction sous ide 6lts	8,95
					0,00
	69499	R69499A Tapa cristal chafing dish summit gn 1/1	Couvercle verre bain marie summit gn 1/1	Summit gn 1/1 chafing dish glass lid	586,30
					0,00
	69501	R69501A Motor para secador de manos c/pulsador	Moteur pour sèche-mains électrique	Motor for electric hand dryer w/button	48,95
	69501	R69501B Resistencia de calentamiento para 69501	Chauffe pour sèche-mains électrique	Heating resistance for elec hand dryer	9,45
	69501	R69501C Placa de control secador de manos elec.	Plaque du control sèche-mains elec.	Pcb mainboard electric hand dryer	34,70
	69523	R69523A Puerta deshidratador aliment.pro 600w	Porte pour deshydrat.aliments pro 600w	Food dehydrator pro 600w spare door	11,30
	69523	R69523B Bandeja deshidratador alimentos pro 600w	Plat deshydrateur des aliments pro 600 w	Food dehydrator pro 600 w spare tray	6,20
	69523	R69523C Bisagras deshidratador aliment.pro 600w	Charnières deshydrat.aliments pro 600w	Food dehydrator pro 600w spare hinges	4,40
	69523	R69523D Pie goma deshidratador aliment.pro 600w	Pie caoutch.deshydrat.aliments pro 600w	Food dehydrator pro 600w rubber foot	4,40
	69523	R69523E Ventilador deshidratador aliment.pro600w	Ventilateur deshydrat.aliments pro 600w	Food dehydrator pro 600w spare fan	15,65
	69523	R69523F Resistencia deshidratad.aliment.pro 600w	Resistor deshydrateur aliments pro 600w	Food dehydrator pro 600w spare heater	7,85
	69523	R69523G Interr.+pot.deshidratad.aliment.pro 600w	Inter+contrôl.deshydrat.aliments pro600w	Food dehydrator pro 600w switch+control	13,65
	69561	R69561G Engranaje conjunto motor 69561	Motoréducteur mixte pour 69561	Joint gear motor for 69561	8,65
	69561	R69561H Set 4 pies goma 69561	Set 4 pieds en caoutchouc pour 69561	Set 4 rubber feet 69561	9,35
	69561	R69561J Placa panel de control 69561	Pcb panneau de commande 69561	Control panel pcb for 69561	25,05
	69561	R69561K Placa de control general 69561	Panneau de commande general 69561	Main control board for 69561	89,65
	69561	R69561i Placa display para 69561	Panneau display pour 69561	Display board for 69561	22,40
	69561	R69561M Motor para 69561	Moteur pour 69561	Electr.motor fur 69561	134,30
	69561	R69561S Espatula para 69561	Statule complète pour 69561	Complete espatula for 69561	6,30
	69561	R69561T Batidor mariposa para 69561	Mélangeur pour 69561	Mixing trowel for 69561	4,15
	69561	R69561V Accesorio amasador para 69561	Accessorie pétrisseur pour 69561	Kneading accessory for 69561	25,25
	69561	R69561W Vaso medidor para 69561	Verre doseur measuring cup pour 69561	Measuring cup for 69561	2,15
	69561	R69561Z Anilla fijación cuchillas para 69561	Fixation du lamé pour 69561	Jug blades locking base for 69561	2,15
					0,00
	69722	R69722A Placa control batidor brisk 69722	Plaque control mixeur brisk 69722	Pcb immersion blender 69722	32,65
	69722	R69722B Mandos de control batidor brisk 69722-3	Boutons de commande mixeur brisk 69722-3	Control buttons blender 69722-3	13,15
	69722	R69722C Motor batidor brisk 69722-3	Moteur pour mixeur brisk 69722-3	Brisk immersion blender motor 69722-3	82,70
	69722	R69722D Conectores batidor brisk 69722-3	Connecteurs mixeur brisk 69722-3	Connection parts blender 69722-3	5,10



Ref.	Repuesto	Descripción	Description	Description	€	
69722	R69722F	Conjunto cuchilla batidor brisk 69722-3	Set lame pour mixeur brisk 69722-3	Brisk immersion blender blade set69722-3	52,20	
69722	R69722G	Set tapas tornillo batidor brisk 69722-3	Vis couvercle mixeur brisk 69722-3	Screw lids for blender 69722-3	5,30	
69722	R69722H	lave desmontaje cuchilla brisk 69722-3	Outil de demontage lame brisk 69722	Blade disassembly tool blender 69722-3	34,80	
69723	R69723A	Placa control batidor brisk 69723	Plaque control mixeur brisk 69723	Pcb immersion blender 69723	34,80	
69735	R69735A	Placa control bat. Brisk 69735	Plaque control mixeur 69735	Pcb immersion blender 69735	34,80	
69735	R69735B	Mandos de control batidor 69735-36-50-51	Boutons commande mixeur 69735-36-50-51	Control buttons blender 69735-36-50-51	11,80	
69735	R69735C	Motor batidor brisk 69735-36	Moteur pour mixeur brisk 69735-36	Brisk blender motor 69735-36	60,95	
69735	R69735D	Conectores batidor brisk 69735-36-50-51	Connecteurs mixeur brisk 69735-36-50-51	Connection parts blender 69735-36-50-51	15,15	
69735	R69735F	Conjunto cuchilla batidor 69735-36-50-51	Set lame pour mixeur 69735-36-50-51	Brisk blender blade set 69735-36-50-51	66,55	
69735	R69735G	Set tapas tornillo 69735-36-50-51	Vis couvercle mixeur 69735-36-50-51	Screw lids for blender 69735-36-50-51	6,10	
69735	R69735H	lave desmontaje cuchilla 69735-36-50-51	Outil de demontage lame 69735-36-50-51	Blade disassembly tool for69735-36-50-51	58,80	
69736	R69736A	Placa control bat. Brisk 69736	Plaque control mixeur 69736	Pcb immersion blender 69736	37,05	
69750	R69750A	Motor batidor brisk 69750-51	Moteur pour mixeur brisk 69750-51	Brisk blender motor 69750-51	60,95	
69750	R69750B	Placa control bat. Brisk 69750	Plaque control mixeur 69750	Pcb immersion blender 69750	34,80	
69751	R69751A	Placa control bat. Brisk 69751	Plaque control mixeur 69751	Pcb immersion blender 69751	37,05	
69815	R69815A	Conector superior para 69815	Connecteur superieur pour 69815	Brisk blender upper connectors 69815	26,15	
69815	R69815B	Set engranajes para 69815	Set engrènement pour 69815	Gear box set for 69815	65,30	
69815	R69815C	Set rodamientos para 69815	Set roulements pour 69815	Bearing set for 69815	37,05	
69815	R69815D	Conjunto varillas inox para 69815	Jeu de 2 batteurs pour 69815	St. steel beaters hooks for 69815	29,60	
69816	R69816A	Eje de transmision batidor brisk 69722-3	Transmission axe mixeur brisk 69722-3	Brisk blender transmission axle 69722-3	28,30	
69820	R69820A	Eje transmision batidor 69820	Transmission axe mixeur 69820	Blender transmission axle 69820	28,30	
69824	R69824A	Conector superior para 69824-34	Connecteur superieur pour 69824-34	Brisk blender upper connectors 69824-34	28,30	
69824	R69824B	Set engranajes para 69824-34	Set engrènement pour 69824-34	Gear box set for 69824-34	65,30	
69824	R69824C	Set rodamientos para 69824-34	Set roulements pour 69824-34	Bearing set for 69824-34	37,05	
69824	R69824D	Conjunto varillas inox para 69824	Jeu de 2 batteurs pour 69824	St. steel beaters hooks for 69824	31,35	
69825	R69825A	Eje transmision batidor 69825	Transmission axe mixeur 69825	Blender transmission axle 69825	32,55	
69830	R69830A	Eje transmision batidor 69830	Transmission axe mixeur 69830	Blender transmission axle 69830	43,45	
69840	R69840A	Eje transmision batidor 69840	Transmission axe mixeur 69840	Blender transmission axle 69840	52,20	
69850	R69850A	Eje transmision batidor 69850	Transmission axe mixeur 69850	Blender transmission axle 69850	67,35	
	71710	R71710	6 pinchos fondue	Jeu 6 fourchettes à fondue	6 pcs fondue forks	6,90
	71710	R71710A	Base giratoria fondue	Base tournante fondue	Revolving fondue base	24,95
	71710	R71711	6 cucharas fondue	Jeu 6 cuillères à fondue	6 pcsfondue spoons	6,70
	71710	R71723	Taza inox fondue	Bol à fondue	St. steel fondue cup	2,05
	71723	R71710	6 pinchos fondue	Jeu 6 fourchettes à fondue	6 pcs fondue forks	6,90
	71723	R71711	6 cucharas fondue	Jeu 6 cuillères à fondue	6 pcsfondue spoons	6,70
	71723	R71723	Taza inox fondue	Bol à fondue	St. steel fondue cup	2,05
	71812	R71810	Junta silicona olla pres. inox 12-15-20	Joint en silicone pour cocotte à pressio	Silicone joint for pressure cooker	14,05
	71812	R71811	Asa cuerpo olla a presion inox 12-15-20	Anse pour cocotte à presion 12-15-20	Handle for pressure cooker stock pot	5,60
	71812	R71812	Asa tapa olla a presion inox 12-15-20	Anse pour couvercle cocotte 12-15-20	Handle for pressure cooker lid 12-15-20	14,25
	71812	R71813	Valvula roja olla a presion 12-15-20	Valve a pression pour cocotte 12-15-20	Pressure valve for press.cooker 12-15-20	13,15
	71812	R71814	Valvula seguridad olla presion 12-15-20	Valve de securit pour cocotte 12-15-20	Safety valve for press cooker 12-15-20 l	8,55
	71812	R71815	Valvula contrapeso olla presion 12-15-20	Valve lourde pour cocotte 12-15-20	Heavy valve for press cooker 12-15-20	23,40
	71812	R71816	Tapa completa olla a presion 12-15-20 lt	Couvercle avec joint pour cocot.12-15-20	lid with joins for press cooker 12-15-20	158,40
	71812	R71816A	Tuerca aluminio olla presion 71812-15-21	Écrou en aluminium cocotte à presion	Aluminium nut-pressure cook 71812-15-21	3,35
	71812	R71816B	Chimenea+tuercas inox olla 71812/15/21	Cheminée et écrou inox c.m.71812/15/21	St steel chimney+nut press.c.71812/15/21	2,75
	71815	R71810	Junta silicona olla pres. inox 12-15-20	Joint en silicone pour cocotte à pressio	Silicone joint for pressure cooker	14,05
	71815	R71811	Asa cuerpo olla a presion inox 12-15-20	Anse pour cocotte à presion 12-15-20	Handle for pressure cooker stock pot	5,60
	71815	R71812	Asa tapa olla a presion inox 12-15-20	Anse pour couvercle cocotte 12-15-20	Handle for pressure cooker lid 12-15-20	14,25
	71815	R71813	Valvula roja olla a presion 12-15-20	Valve a pression pour cocotte 12-15-20	Pressure valve for press.cooker 12-15-20	13,15
	71815	R71814	Valvula seguridad olla presion 12-15-20	Valve de securit pour cocotte 12-15-20	Safety valve for press cooker 12-15-20 l	8,55
	71815	R71815	Valvula contrapeso olla presion 12-15-20	Valve lourde pour cocotte 12-15-20	Heavy valve for press cooker 12-15-20	23,40
	71815	R71816	Tapa completa olla a presion 12-15-20 lt	Couvercle avec joint pour cocot.12-15-20	lid with joins for press cooker 12-15-20	158,40
	71815	R71816A	Tuerca aluminio olla presion 71812-15-21	Écrou en aluminium cocotte à presion	Aluminium nut-pressure cook 71812-15-21	3,35
	71815	R71816B	Chimenea+tuercas inox olla 71812/15/21	Cheminée et écrou inox c.m.71812/15/21	St steel chimney+nut press.c.71812/15/21	2,75
	71821	R71810	Junta silicona olla pres. inox 12-15-20	Joint en silicone pour cocotte à pressio	Silicone joint for pressure cooker	14,05
	71821	R71811	Asa cuerpo olla a presion inox 12-15-20	Anse pour cocotte à presion 12-15-20	Handle for pressure cooker stock pot	5,60
	71821	R71812	Asa tapa olla a presion inox 12-15-20	Anse pour couvercle cocotte 12-15-20	Handle for pressure cooker lid 12-15-20	14,25
	71821	R71813	Valvula roja olla a presion 12-15-20	Valve a pression pour cocotte 12-15-20	Pressure valve for press.cooker 12-15-20	13,15
	71821	R71814	Valvula seguridad olla presion 12-15-20	Valve de securit pour cocotte 12-15-20	Safety valve for press cooker 12-15-20 l	8,55
	71821	R71815	Valvula contrapeso olla presion 12-15-20	Valve lourde pour cocotte 12-15-20	Heavy valve for press cooker 12-15-20	23,40
	71821	R71816	Tapa completa olla a presion 12-15-20 lt	Couvercle avec joint pour cocot.12-15-20	lid with joins for press cooker 12-15-20	158,40
	71821	R71816A	Tuerca aluminio olla presion 71812-15-21	Écrou en aluminium cocotte à presion	Aluminium nut-pressure cook 71812-15-21	3,35
	71821	R71816B	Chimenea+tuercas inox olla 71812/15/21	Cheminée et écrou inox c.m.71812/15/21	St steel chimney+nut press.c.71812/15/21	2,75
	71830	R71830A	Valvula de seguridad Suprem	Valve a securité cocotte à pression supr	Suprem pressure cooker security valve	8,55
	71830	R71830B	Valvula de regulacion Suprem	Valve de regulation cocotte à pression s	Suprem pressure cooker regulation valve	8,95
	71830	R71830C	Junta silicona olla presion Suprem 20cm	Joint silicone coc. à pression Suprem 20	Suprem pressure cooker 20c silicon joint	7,35
	71830	R71830D	Mecanismo tapa olla presion Suprem 20cm	Syst.de verouillage couvercle Suprem 20c	Suprem pressure cooker 20cm locking syst	15,95
	71830	R71830E	Asa costado olla presion Suprem d.20cms.	Anse pour cocotte à pression Suprem d.20	Suprem pres. cooker d.20cms. side handle	6,00
	71834	R71834A	Valvula seguridad olla presion garra	Valve de securit pour cocotte à presion	Safety valve for clam pressure cooker	3,45
	71834	R71834B	Valvula reguladora de presion	Valve de regulation cocotte à pression	Clam pressure cooker regulation valve	18,10
	71834	R71834C	Junta silicona olla presion garra d.22cm	Joint silicone cocott.à pression 22 cms	Clam pressure cooker 22c silicon joint	4,25
	71834	R71834D	Cierre superior olla presion garra	Fermeture supérieur pour cocotte presion	Clam pressure cooker upper closing	13,95
	71834	R71834E	Asa costado olla presion garra d.22 cm	Anse pour cocotte à pression d.22 cm	Clam pressure cooker ear handle d.22 cm	3,15
	71834	R71834F	Tapa olla a presión garra d.22 cms	Couvercle pour cocotte à pression d.22cm	Clam pressure cooker d.22 cms spare lid	69,80
	71835	R71834A	Valvula seguridad olla presion garra	Valve de securit pour cocotte à presion	Safety valve for clam pressure cooker	3,45
	71835	R71834B	Valvula reguladora de presion	Valve de regulation cocotte à pression	Clam pressure cooker regulation valve	18,10
	71835	R71834C	Junta silicona olla presion garra d.22cm	Joint silicone cocott.à pression 22 cms	Clam pressure cooker 22c silicon joint	4,25

Ref.	Repuesto	Descripción	Description	Description	€
71835	R71834D	Cierre superior olla presion garra	Fermeture supérieur pour cocotte presion	Clam pressure cooker upper closing	13,95
71835	R71834E	Asa costado olla presion garra d.22 cm	Anse pour cocotte à pression d.22 cm	Clam pressure cooker ear handle d.22 cm	3,15
71835	R71834F	Tapa olla a presión garra d.22 cms	Couvercle pour cocotte à pression d.22cm	Clam pressure cooker d.22 cms spare lid	69,80
71836	R71834A	Valvula seguridad olla presion garra	Valve de securit pour cocotte à presion	Safety valve for clam pressure cooker	3,45
71836	R71834B	Valvula reguladora de presion	Valve de regulation cocotte à pression	Clam pressure cooker regulation valve	18,10
71836	R71834C	Junta silicona olla presion garra d.22cm	Joint silicone cocott.à pression 22 cms	Clam pressure cooker 22c silicon joint	4,25
71836	R71834D	Cierre superior olla presion garra	Fermeture supérieur pour cocotte presion	Clam pressure cooker upper closing	13,95
71836	R71834E	Asa costado olla presion garra d.22 cm	Anse pour cocotte à pression d.22 cm	Clam pressure cooker ear handle d.22 cm	3,15
71836	R71834F	Tapa olla a presión garra d.22 cms	Couvercle pour cocotte à pression d.22cm	Clam pressure cooker d.22 cms spare lid	69,80
71837	R71834A	Valvula seguridad olla presion garra	Valve de securit pour cocotte à presion	Safety valve for clam pressure cooker	3,45
71837	R71834B	Valvula reguladora de presion	Valve de regulation cocotte à pression	Clam pressure cooker regulation valve	18,10
71837	R71834C	Junta silicona olla presion garra d.22cm	Joint silicone cocott.à pression 22 cms	Clam pressure cooker 22c silicon joint	4,25
71837	R71834D	Cierre superior olla presion garra	Fermeture supérieur pour cocotte presion	Clam pressure cooker upper closing	13,95
71837	R71834E	Asa costado olla presion garra d.22 cm	Anse pour cocotte à pression d.22 cm	Clam pressure cooker ear handle d.22 cm	3,15
71837	R71834F	Tapa olla a presión garra d.22 cms	Couvercle pour cocotte à pression d.22cm	Clam pressure cooker d.22 cms spare lid	69,80
71840	R71830A	Valvula de seguridad Suprem	Valve a securité cocotte à pression supr	Suprem pressure cooker security valve	8,55
71840	R71830B	Valvula de regulacion Suprem	Valve de regulation cocotte à pression s	Suprem pressure cooker regulation valve	8,95
71840	R71840C	Junta silicona olla presion Suprem 24cm	Joint silicone coc. à pression Suprem 24	Supre pressure cooker 24c silicone joint	8,85
71840	R71840D	Mecanismo tapa olla presion Suprem 24cm	Syst. verouillage du couvercle Suprem 24	Suprem pressure cooker 24cm locking syst	16,40
71840	R71840E	Asa costado olla presion Suprem d24 cms.	Anse pour cocotte à pression Suprem d.24	Suprem pres. cooker d.24cms. side handle	8,55
71845	R71845A	Tapa olla presion easy c/junta	Couvercle cocotte pression easy a/joint	Easy pressure cooker lid with gasket	67,95
71845	R71845B	Asa lat. olla presion easy	Anse laterale cocotte-minute easy	Side handle for easy press.cooker	3,85
71845	R71845C	Valvula seguridad olla presion easy	Valve de securit cocotte à presion easy	Safety valve for easy pressure cooker	2,75
71845	R71845D	Pomo tapa olla a presion easy	Manette couvercle coc-minute easy	lid knob for easy pressure cooker	19,55
71845	R71845E	Valvula reguladora de presion olla easy	Valve regulation cocotte pression easy	Clam easy press. cook. regulation valve	12,90
71845	R71845F	Junta silicona tapa olla presion easy	Joint en silicone cocotte à press easy	Easy pressure cooker silicone joint	6,10
71846	R71845A	Tapa olla presion easy c/junta	Couvercle cocotte pression easy a/joint	Easy pressure cooker lid with gasket	67,95
71846	R71845B	Asa lat. olla presion easy	Anse laterale cocotte-minute easy	Side handle for easy press.cooker	3,85
71846	R71845C	Valvula seguridad olla presion easy	Valve de securit cocotte à presion easy	Safety valve for easy pressure cooker	2,75
71846	R71845D	Pomo tapa olla a presion easy	Manette couvercle coc-minute easy	lid knob for easy pressure cooker	19,55
71846	R71845E	Valvula reguladora de presion olla easy	Valve regulation cocotte pression easy	Clam easy press. cook. regulation valve	12,90
71846	R71845F	Junta silicona tapa olla presion easy	Joint en silicone cocotte à press easy	Easy pressure cooker silicone joint	6,10
71847	R71845A	Tapa olla presion easy c/junta	Couvercle cocotte pression easy a/joint	Easy pressure cooker lid with gasket	67,95
71847	R71845B	Asa lat. olla presion easy	Anse laterale cocotte-minute easy	Side handle for easy press.cooker	3,85
71847	R71845C	Valvula seguridad olla presion easy	Valve de securit cocotte à presion easy	Safety valve for easy pressure cooker	2,75
71847	R71845D	Pomo tapa olla a presion easy	Manette couvercle coc-minute easy	lid knob for easy pressure cooker	19,55
71847	R71845E	Valvula reguladora de presion olla easy	Valve regulation cocotte pression easy	Clam easy press. cook. regulation valve	12,90
71847	R71845F	Junta silicona tapa olla presion easy	Joint en silicone cocotte à press easy	Easy pressure cooker silicone joint	6,10
71855	R71830A	Valvula de seguridad Suprem	Valve a securité cocotte à pression supr	Suprem pressure cooker security valve	8,55
71855	R71830B	Valvula de regulacion Suprem	Valve de regulation cocotte à pression s	Suprem pressure cooker regulation valve	8,95
71855	R71830C	Junta silicona olla presion Suprem 20cm	Joint silicone coc. à pression Suprem 20	Suprem pressure cooker 20c silicon joint	7,35
71855	R71830D	Mecanismo tapa olla presion Suprem 20cm	Syst.de verouillage couvercle Suprem 20c	Suprem pressure cooker 20cm locking syst	15,95
71855	R71830E	Asa costado olla presion Suprem d.20cms.	Anse pour cocotte à pression Suprem d.20	Suprem pres. cooker d.20cms. side handle	6,00
71860	R71830A	Valvula de seguridad Suprem	Valve a securité cocotte à pression supr	Suprem pressure cooker security valve	8,55
71860	R71830B	Valvula de regulacion Suprem	Valve de regulation cocotte à pression s	Suprem pressure cooker regulation valve	8,95
71860	R71840C	Junta silicona olla presion Suprem 24cm	Joint silicone coc. à pression Suprem 24	Supre pressure cooker 24c silicone joint	8,85
71860	R71840D	Mecanismo tapa olla presion Suprem 24cm	Syst. verouillage du couvercle Suprem 24	Suprem pressure cooker 24cm locking syst	16,40
71860	R71840E	Asa costado olla presion Suprem d24 cms.	Anse pour cocotte à pression Suprem d.24	Suprem pres. cooker d.24cms. side handle	8,55
71864	R71864A	Tapa olla presion tempo d. 22cm c/junta	Couvercle cocotte a pression tempo d. 22	Tempo pressure cooker lid d. 22 cm with	24,20
71864	R71864B	Junta silic.tapa olla presion tempo d.22	Joint en silicone p/couver. cocotte à pr	Tempo pressure cooker silicone joint d.	3,45
71864	R71864C	Mango tapa olla a presion tempo d.22 cms	Poignée à couvercle, cocotte à pression	Tempo pressure cooker longhandle d. 22 c	3,35
71864	R71864D	Mango cuerpo olla a presion tempo d.22cm	Poignée marmite, cocotte à pression d.22	Tempo pressure cooker body longhandle d.	2,95
71864	R71864E	Valvula de seguridad olla a presion d.22	Valve de sécurité cocotte à pression d.2	Pressure cooker safety valve d. 2 cms	1,40
71864	R71864F	Asa cuerpo olla a presion d.22 cms	Anse latérale cocotte à pression d.22 cm	Pressure cooker side handle d. 22 cms	1,75
71864	R71864G	Valvula presion olla a presion d.22 cms	Valve de pression cocotte à pression d.2	Pressure cooker pressure valve d. 22 cms	2,95
71866	R71864A	Tapa olla presion tempo d. 22cm c/junta	Couvercle cocotte a pression tempo d. 22	Tempo pressure cooker lid d. 22 cm with	24,20
71866	R71864B	Junta silic.tapa olla presion tempo d.22	Joint en silicone p/couver. cocotte à pr	Tempo pressure cooker silicone joint d.	3,45
71866	R71864C	Mango tapa olla a presion tempo d.22 cms	Poignée à couvercle, cocotte à pression	Tempo pressure cooker longhandle d. 22 c	3,35
71866	R71864D	Mango cuerpo olla a presion tempo d.22cm	Poignée marmite, cocotte à pression d.22	Tempo pressure cooker body longhandle d.	2,95
71866	R71864E	Valvula de seguridad olla a presion d.22	Valve de sécurité cocotte à pression d.2	Pressure cooker safety valve d. 2 cms	1,40
71866	R71864F	Asa cuerpo olla a presion d.22 cms	Anse latérale cocotte à pression d.22 cm	Pressure cooker side handle d. 22 cms	1,75
71866	R71864G	Valvula presion olla a presion d.22 cms	Valve de pression cocotte à pression d.2	Pressure cooker pressure valve d. 22 cms	2,95
71868	R71864A	Tapa olla presion tempo d. 22cm c/junta	Couvercle cocotte a pression tempo d. 22	Tempo pressure cooker lid d. 22 cm with	24,20
71868	R71864B	Junta silic.tapa olla presion tempo d.22	Joint en silicone p/couver. cocotte à pr	Tempo pressure cooker silicone joint d.	3,45
71868	R71864C	Mango tapa olla a presion tempo d.22 cms	Poignée à couvercle, cocotte à pression	Tempo pressure cooker longhandle d. 22 c	3,35
71868	R71864D	Mango cuerpo olla a presion tempo d.22cm	Poignée marmite, cocotte à pression d.22	Tempo pressure cooker body longhandle d.	2,95
71868	R71864E	Valvula de seguridad olla a presion d.22	Valve de sécurité cocotte à pression d.2	Pressure cooker safety valve d. 2 cms	1,40
71868	R71864F	Asa cuerpo olla a presion d.22 cms	Anse latérale cocotte à pression d.22 cm	Pressure cooker side handle d. 22 cms	1,75
71868	R71864G	Valvula presion olla a presion d.22 cms	Valve de pression cocotte à pression d.2	Pressure cooker pressure valve d. 22 cms	2,95
71871	R71874D	Contrapeso+esp.vap+tuerca o.pres.classic	Contre poids+chev.vap.+ecrou c.p. classi	Counterweight+ steam vent+nut p.c. clas	4,50
71871	R71874E	Valvula seguridad olla presión classic	Valve de securite cocote minute classic	Security valve for pres. cooker classic	1,55
71871	R71874F	Asa lat. olla presion classic d.22-24	Anse laterale cocotte-minute 22-24	22-24side handle for bridge press.cooker	2,15
71871	R71874G	Cest.+trip. olla p. classic d.22-24cms.	Panier cuit-vapeur+trépied 22-24 cms.	22-24 cm steamer+rack pres.cook classic	4,50

Ref.	Repuesto	Descripción	Description	Description	€
71871	R71874J	Accesorios pomo olla classic	Accessoires bouton pour pot classic	Accessories for	6,60
71872	R71872A	Asa lat. olla presion classic 12 l	Anse laterale cocotte-minute 12l	Side handle for bridge press.cooker 12 l	4,80
71872	R71872B	Pomo tapa olla classic 12 lts	Manette couvercle cocotte-minute 71872	lid knob for classic pres.cook 12 l	3,75
71872	R71872C	Puente para olla a presion classic 12 l	Pont pour cocotte-minute classic 12l	Bridge for classic pres.cook 12 l	11,80
71872	R71872D	Cestillo olla a presion classic 12 l	Panier passoire vapeur pour 71872	Steam strainer basket fur 71872	6,30
71872	R71872E	Junta silion a olla classic 12 lts	Joint solicon cocotte-minute classic 12l	Silicone ring for classic pres.cook 12 l	4,50
71872	R71872F	Tapa olla presion classic 12 l	Couvercle cocotte a pression classic12 l	Classic pressure cooker lid 12 l	58,90
71872	R71872G	Contrap+esp.vap+tuerca olla classic 12l	Contre poids+chev.vap.+ecrou pour 71872	Counterweight+ steam vent+nut for 71872	4,50
71872	R71872H	Valvula de seguridad olla classic 12 l	Valve de secur cocote minute classic 12l	Security valve pres. cooker classic 12l	2,55
71872	R71872K	Accesorios pomo olla classic 12-15l	Accessoires bouton pot classic 12-15l	Accessories for 71872-71875	13,65
71874	R71874A	Tapa olla presion classic d. 22 cms.	Couvercle cocotte-minute classique 22 cms	22 cms. lid classic bridge pres.cooker	18,60
71874	R71874B	Jun. silic. olla pres. classic d.22cms.	Joint solicone cocotte-minute couv. 22cm	22 cms. silicone ring for brig.pres.cook	3,45
71874	R71874C	Puente+pomo olla pres. classic d.22cms.	Couvercle+bouton cocotte-minuteouvr22	22 cm.bridge+knob for bridge prescooker	9,55
71874	R71874D	Contrapeso+esp.vap+tuerca o.pres.classic	Contre poids+chev.vap.+ecrou c.p. classi	Counterweight+ steam vent+nut p.c. clas	4,50
71874	R71874E	Valvula seguridad olla presión classic	Valve de securite cocote minute classic	Security valve for pres. cooker classic	1,55
71874	R71874F	Asa lat. olla presion classic d.22-24	Anse laterale cocotte-minute 22-24	22-24side handle for bridge press.cooker	2,15
71874	R71874G	Cest.+trip. olla p. classic d.22-24cms.	Panier cuit-vapeur+trépied 22-24 cms.	22-24 cm steamer+rack pres.cook classic	4,50
71874	R71874H	Pomo completo olla presion 71874-6	Bouton pour couvercle 71874-6	Bridge pressure cooker lid knob 71874-6	7,55
71874	R71874J	Accesorios pomo olla classic	Accessoires bouton pour pot classic	Accessories for	6,60
71875	R71872A	Asa lat. olla presion classic 12 l	Anse laterale cocotte-minute 12l	Side handle for bridge press.cooker 12 l	4,80
71875	R71872B	Pomo tapa olla classic 12 lts	Manette couvercle cocotte-minute 71872	lid knob for classic pres.cook 12 l	3,75
71875	R71872C	Puente para olla a presion classic 12 l	Pont pour cocotte-minute classic 12l	Bridge for classic pres.cook 12 l	11,80
71875	R71872D	Cestillo olla a presion classic 12 l	Panier passoire vapeur pour 71872	Steam strainer basket fur 71872	6,30
71875	R71872E	Junta silion a olla classic 12 lts	Joint solicon cocotte-minute classic 12l	Silicone ring for classic pres.cook 12 l	4,50
71875	R71872F	Tapa olla presion classic 12 l	Couvercle cocotte a pression classic12 l	Classic pressure cooker lid 12 l	58,90
71875	R71872G	Contrap+esp.vap+tuerca olla classic 12l	Contre poids+chev.vap.+ecrou pour 71872	Counterweight+ steam vent+nut for 71872	4,50
71875	R71872H	Valvula de seguridad olla classic 12 l	Valve de secur cocote minute classic 12l	Security valve pres. cooker classic 12l	2,55
71876	R71874A	Tapa olla presion classic d. 22 cms.	Couvercle cocotte-minute classique 22 cms	22 cms. lid classic bridge pres.cooker	18,60
71876	R71874B	Jun. silic. olla pres. classic d.22cms.	Joint solicone cocotte-minute couv. 22cm	22 cms. silicone ring for brig.pres.cook	3,45
71876	R71874C	Puente+pomo olla pres. classic d.22cms.	Couvercle+bouton cocotte-minuteouvr22	22 cm.bridge+knob for bridge prescooker	9,55
71876	R71874D	Contrapeso+esp.vap+tuerca o.pres.classic	Contre poids+chev.vap.+ecrou c.p. classi	Counterweight+ steam vent+nut p.c. clas	4,50
71876	R71874E	Valvula seguridad olla presión classic	Valve de securite cocote minute classic	Security valve for pres. cooker classic	1,55
71876	R71874F	Asa lat. olla presion classic d.22-24	Anse laterale cocotte-minute 22-24	22-24side handle for bridge press.cooker	2,15
71876	R71874G	Cest.+trip. olla p. classic d.22-24cms.	Panier cuit-vapeur+trépied 22-24 cms.	22-24 cm steamer+rack pres.cook classic	4,50
71876	R71874J	Accesorios pomo olla classic	Accessoires bouton pour pot classic	Accessories for	6,60
71878	R71874D	Contrapeso+esp.vap+tuerca o.pres.classic	Contre poids+chev.vap.+ecrou c.p. classi	Counterweight+ steam vent+nut p.c. clas	4,50
71878	R71874E	Valvula seguridad olla presión classic	Valve de securite cocote minute classic	Security valve for pres. cooker classic	1,55
71878	R71874F	Asa lat. olla presion classic d.22-24	Anse laterale cocotte-minute 22-24	22-24side handle for bridge press.cooker	2,15
71878	R71874G	Cest.+trip. olla p. classic d.22-24cms.	Panier cuit-vapeur+trépied 22-24 cms.	22-24 cm steamer+rack pres.cook classic	4,50
71878	R71874J	Accesorios pomo olla classic	Accessoires bouton pour pot classic	Accessories for	6,60
71878	R71878A	Tapa olla presion classic d.24cms.	Couvercle cocotte-minute classique 24 cm	24 cms. lid for/classic brid.pres.cooker	22,60
71878	R71878B	Junta sil. olla presion classic d.24cms.	Joint silicone cocotte-minute 24 cms.	24 cm.sil.ring f/bridge pres.cooker	3,75
71878	R71878C	Puente+pomo olla p. classic d.24cms.	Couvercle+bouton cocotte-minute ouv24	24 cms. bridge+knob bridge prescooker	12,40
71889	R71830A	Valvula de seguridad Suprem	Valve a securité cocotte à pression supr	Suprem pressure cooker security valve	8,55
71889	R71830B	Valvula de regulacion Suprem	Valve de regulation cocotte à pression s	Suprem pressure cooker regulation valve	8,95
71889	R71840C	Junta silicona olla presion Suprem 24cm	Joint silicone coc. à pression Suprem 24	Supre pressure cooker 24c silicone joint	8,85
71889	R71840D	Mecanismo tapa olla presion Suprem 24cm	Syst. verouillage du couvercle Suprem 24	Suprem pressure cooker 24cm locking syst	16,40
71889	R71840E	Asa costado olla presion Suprem d24 cms.	Anse pour cocotte à pression Suprem d.24	Suprem pres. cooker d.24cms. side handle	8,55
85016	R85000	Repuesto asa costado estudio	Anse estudio	Estudio side handle	2,75
85016	R85002	Repuesto pomo estudio	Recharge bouton studio	Estudio replacement knob	2,05
85016	R85003	Repuesto arandela estudio	Recharge rondelle estudio	Estudio replacement washer	1,10
85018	R85000	Repuesto asa costado estudio	Anse estudio	Estudio side handle	2,75
85018	R85002	Repuesto pomo estudio	Recharge bouton studio	Estudio replacement knob	2,05
85018	R85003	Repuesto arandela estudio	Recharge rondelle estudio	Estudio replacement washer	1,10
85020	R85000	Repuesto asa costado estudio	Anse estudio	Estudio side handle	2,75
85020	R85002	Repuesto pomo estudio	Recharge bouton studio	Estudio replacement knob	2,05
85020	R85003	Repuesto arandela estudio	Recharge rondelle estudio	Estudio replacement washer	1,10
85022	R85000	Repuesto asa costado estudio	Anse estudio	Estudio side handle	2,75
85022	R85002	Repuesto pomo estudio	Recharge bouton studio	Estudio replacement knob	2,05
85022	R85003	Repuesto arandela estudio	Recharge rondelle estudio	Estudio replacement washer	1,10
85024	R85000	Repuesto asa costado estudio	Anse estudio	Estudio side handle	2,75
85024	R85002	Repuesto pomo estudio	Recharge bouton studio	Estudio replacement knob	2,05
85024	R85003	Repuesto arandela estudio	Recharge rondelle estudio	Estudio replacement washer	1,10
85026	R85000	Repuesto asa costado estudio	Anse estudio	Estudio side handle	2,75
85026	R85002	Repuesto pomo estudio	Recharge bouton studio	Estudio replacement knob	2,05
85026	R85003	Repuesto arandela estudio	Recharge rondelle estudio	Estudio replacement washer	1,10
85028	R85000	Repuesto asa costado estudio	Anse estudio	Estudio side handle	2,75
85028	R85002	Repuesto pomo estudio	Recharge bouton studio	Estudio replacement knob	2,05
85028	R85003	Repuesto arandela estudio	Recharge rondelle estudio	Estudio replacement washer	1,10
85032	R85000	Repuesto asa costado estudio	Anse estudio	Estudio side handle	2,75
85032	R85002	Repuesto pomo estudio	Recharge bouton studio	Estudio replacement knob	2,05
85032	R85003	Repuesto arandela estudio	Recharge rondelle estudio	Estudio replacement washer	1,10
85116	R85000	Repuesto asa costado estudio	Anse estudio	Estudio side handle	2,75
85116	R85002	Repuesto pomo estudio	Recharge bouton studio	Estudio replacement knob	2,05
85116	R85003	Repuesto arandela estudio	Recharge rondelle estudio	Estudio replacement washer	1,10
85118	R85000	Repuesto asa costado estudio	Anse estudio	Estudio side handle	2,75
85118	R85002	Repuesto pomo estudio	Recharge bouton studio	Estudio replacement knob	2,05
85118	R85003	Repuesto arandela estudio	Recharge rondelle estudio	Estudio replacement washer	1,10
85120	R85000	Repuesto asa costado estudio	Anse estudio	Estudio side handle	2,75
85120	R85002	Repuesto pomo estudio	Recharge bouton studio	Estudio replacement knob	2,05
85120	R85003	Repuesto arandela estudio	Recharge rondelle estudio	Estudio replacement washer	1,10







Ref.	Repuesto	Descripción	Description	Description	€
88622	R88000	Baquelita asa costado Nova   adycor	Anse Nova   adycor	Nova   adycor side handle	6,00
88622	R88003	Asa tapa Nova   adycor	Anse pour couvercle Nova   adycor	Handle for lid Nova   adycor	2,15
88624	R88000	Baquelita asa costado Nova   adycor	Anse Nova   adycor	Nova   adycor side handle	6,00
88624	R88003	Asa tapa Nova   adycor	Anse pour couvercle Nova   adycor	Handle for lid Nova   adycor	2,15
88626	R88000	Baquelita asa costado Nova   adycor	Anse Nova   adycor	Nova   adycor side handle	6,00
88626	R88003	Asa tapa Nova   adycor	Anse pour couvercle Nova   adycor	Handle for lid Nova   adycor	2,15
88628	R88000	Baquelita asa costado Nova   adycor	Anse Nova   adycor	Nova   adycor side handle	6,00
88628	R88003	Asa tapa Nova   adycor	Anse pour couvercle Nova   adycor	Handle for lid Nova   adycor	2,15
88632	R88000	Baquelita asa costado Nova   adycor	Anse Nova   adycor	Nova   adycor side handle	6,00
88632	R88003	Asa tapa Nova   adycor	Anse pour couvercle Nova   adycor	Handle for lid Nova   adycor	2,15
88712	R88002	Baquelita mango pote Nova   adycor	Bouton couvercle Nova   adycor	Knob for lid Nova   adycor	2,95
88714	R88002	Baquelita mango pote Nova   adycor	Bouton couvercle Nova   adycor	Knob for lid Nova   adycor	2,95
88716	R88002	Baquelita mango pote Nova   adycor	Bouton couvercle Nova   adycor	Knob for lid Nova   adycor	2,95
88718	R88002	Baquelita mango pote Nova   adycor	Bouton couvercle Nova   adycor	Knob for lid Nova   adycor	2,95
71872	R71872A	Asa   at. Olla Presion Classic 12	Anse   aterale Cocotte-Minute 12	Side Handle For Bridge Press.Cooker 12	4,80
71872	R71872B	Pomo Tapa Olla Classic 12   ts	Manette Couvercle Cocotte-Minute 71872	id Knob For Classic Pres.Cook 12	3,75
71872	R71872C	Puente Para Olla A Presion Classic 12	Pont Pour Cocotte-Minute Classic 12	Bridge For Classic Pres.Cook 12	11,80
71872	R71872D	Cestillo Olla A Presion Classic 12	Panier Passoire Vapeur Pour 71872	Steam Strainer Basket Fur 71872	6,30
71872	R71872E	Junta Siliona Olla Classic 12   ts	Joint Solicon Cocotte-Minute Classic 12	Silicone Ring For Classic Pres.Cook 12	4,50
71872	R71872F	Tapa Olla Presion Classic 12	Couvercle Cocotte A Pression Classic12	Classic Pressure Cooker   id 12	58,90
71872	R71872G	Contrap+Esp.Vap+Tuerca Olla Classic 12	Contre Poids+Chev.Vap.+Ecrou Pour 71872	Counterweight+ Steam Vent+Nut For 71872	4,50
71872	R71872H	Valvula De Seguridad Olla Classic 12	Valve De Secur Cocotte Minute Classic 12	Security Valve Pres. Cooker Classic 12	2,55
71872	R71872J	Nueva Asa   at. Olla Presion Classic 12	Nouveau Anse   aterale Cocotte-Minute 12	New Side Handle Bridge Press.Cooker 12	4,70
71875	R71872A	Asa   at. Olla Presion Classic 12	Anse   aterale Cocotte-Minute 12	Side Handle For Bridge Press.Cooker 12	4,80
71875	R71872B	Pomo Tapa Olla Classic 12   ts	Manette Couvercle Cocotte-Minute 71872	id Knob For Classic Pres.Cook 12	3,75
71875	R71872C	Puente Para Olla A Presion Classic 12	Pont Pour Cocotte-Minute Classic 12	Bridge For Classic Pres.Cook 12	11,80
71875	R71872D	Cestillo Olla A Presion Classic 12	Panier Passoire Vapeur Pour 71872	Steam Strainer Basket Fur 71872	6,30
71875	R71872E	Junta Siliona Olla Classic 12   ts	Joint Solicon Cocotte-Minute Classic 12	Silicone Ring For Classic Pres.Cook 12	4,50
71875	R71872F	Tapa Olla Presion Classic 12	Couvercle Cocotte A Pression Classic12	Classic Pressure Cooker   id 12	58,90
71875	R71872G	Contrap+Esp.Vap+Tuerca Olla Classic 12	Contre Poids+Chev.Vap.+Ecrou Pour 71872	Counterweight+ Steam Vent+Nut For 71872	4,50
71875	R71872H	Valvula De Seguridad Olla Classic 12	Valve De Secur Cocotte Minute Classic 12	Security Valve Pres. Cooker Classic 12	2,55
71875	R71872J	Nueva Asa   at. Olla Presion Classic 12	Nouveau Anse   aterale Cocotte-Minute 12	New Side Handle Bridge Press.Cooker 12	4,70
20518	R20518A	Tapa Olla Presion Pro-Classic 18	Couver. Cocotte Pression Pro-Classic18	Pro-Classic Pressure Cooker   id 18	65,45
20518	R20518B	Puente Olla A Presion Pro-Classic 18	Pont Cocotte-Minute Pro-Classic 18	Bridge For Pro-Classic Pres.Cook 18	16,40
20518	R20518C	Asa   at. Olla Presion Pro-Classic 18	Anse   aterale Cocotte-Minute 20518-22	Side Handle P.Cook. Pro-Classic 18-22	5,00
20518	R20518D	Pomo Tapa Olla Pro-Classic 18   ts	Manette Couvercle Cocotte-Minute 18-22	id Knob Pro-Classic Pres.Cook 18-22	10,30
20518	R20518E	Contrap+Esp.Vap+Tuerca Pro-Classic 18	Contre Poids+Chev.Vap.+Ecrou 20518-22	Counterweight+ Steam Vent+Nut 20518-22	4,15
20518	R20518F	Valvula Seguridad Olla Pro-Classic 18	Valve Secur Cocot Min Pro-Classic 18-22	Secur. Valve P.Cook. Pro-Classic 18-22	1,75
20518	R20518G	Junta Siliona Olla Pro-Classic 18	Joint Solicon Cocotte-Minute 20518	Silicone Ring Pro-Classic Pres.Cook 18	2,85
20522	R20522A	Tapa Olla Presion Pro-Classic 18	Couver. Cocotte Pression Pro-Classic22	Pro-Classic Pressure Cooker   id 22	31,95
20522	R20522B	Puente Olla A Presion Pro-Classic 18	Pont Cocotte-Minute Pro-Classic 22	Bridge For Pro-Classic Pres.Cook 22	28,70
20522	R20518C	Asa   at. Olla Presion Pro-Classic 18	Anse   aterale Cocotte-Minute 20518-22	Side Handle P.Cook. Pro-Classic 18-22	5,00
20522	R20518D	Pomo Tapa Olla Pro-Classic 18   ts	Manette Couvercle Cocotte-Minute 18-22	id Knob Pro-Classic Pres.Cook 18-22	10,30
20522	R20518E	Contrap+Esp.Vap+Tuerca Pro-Classic 18	Contre Poids+Chev.Vap.+Ecrou 20518-22	Counterweight+ Steam Vent+Nut 20518-22	4,15
20522	R20518F	Valvula Seguridad Olla Pro-Classic 18	Valve Secur Cocot Min Pro-Classic 18-22	Secur. Valve P.Cook. Pro-Classic 18-22	1,75
20522	R20522G	Junta Siliona Olla Pro-Classic 22	Joint Solicon Cocotte-Minute 20522	Silicone Ring Pro-Classic Pres.Cook 22	3,35
20615	R20618A	Tapa Olla Presion Aluminio 18  ts C/Junta	Couvercle Cocotte-Minute En Alum.15-18  t	Aluminium Pressure Cooker   id 15-18   ts	67,25
20615	R20618B	Junta Silic.Tapa Olla Pres.Alum.15-18   t	Joint Sil.Cocotte-Minute En Alum.15-18  t	Aluminium Pressure Cooker Gasket 15-18  t	5,70
20615	R20618C	Puente+pomo olla presion alum.15-18 Its	Couver.+bouton cocotte-minute al.15-18 t	15-18 Its bridge+knob bridge pres.cooker	27,10
20615	R20618D	Contrapeso+Esp.Vap+Tuerca O.Pres.15-18  t	Contre Poids+Chev.Vap.+Ecrou C.Pres.1518	Counterweight+Steam Vent+Nut Al.Pr.15-18	7,00
20615	R20618E	Valvula Seguridad Olla A Presion 15-18  t	Valve Sécurité Cocotte À Pression 15-18	Alum.Pressure Cooker Safety Valve 15-18	5,70
20615	R20618F	Asa   ateral Olla Presion Aluminio 15-18	Anse   aterale Cocotte-Minute Alum.15-18	15-18   ts Ear Handle Bridge Press.Cooker	4,80
20618	R20618A	Tapa Olla Presion Aluminio 18  ts C/Junta	Couvercle Cocotte-Minute En Alum.15-18  t	Aluminium Pressure Cooker   id 15-18   ts	67,25
20618	R20618B	Junta Silic.Tapa Olla Pres.Alum.15-18   t	Joint Sil.Cocotte-Minute En Alum.15-18  t	Aluminium Pressure Cooker Gasket 15-18  t	5,70
20618	R20618D	Contrapeso+Esp.Vap+Tuerca O.Pres.15-18  t	Contre Poids+Chev.Vap.+Ecrou C.Pres.1518	Counterweight+Steam Vent+Nut Al.Pr.15-18	7,00
20618	R20618E	Valvula Seguridad Olla A Presion 15-18  t	Valve Sécurité Cocotte À Pression 15-18	Alum.Pressure Cooker Safety Valve 15-18	5,70
20618	R20618F	Asa   ateral Olla Presion Aluminio 15-18	Anse   aterale Cocotte-Minute Alum.15-18	15-18   ts Ear Handle Bridge Press.Cooker	4,80
60516	R60516A	Mano Para Mortero Granito 16X12 Cms	Pilon Pour Granit Mortier 16X12 Cms	Pestle For Granite Mortar16X12 Cms	1,55
61919	R61919A	Bote Especiero Para Rack Especiero De 4	Etager E A Epices Pour 61919	Spice Pot For 61919	2,15
68643	R68643A	Asa Hervidor Silbante White 2.5	Poignee Bouillore Siffante White-Black	Handle For Whistling Kettle White-Black	4,25
68643	R68643B	Tapa Hervidor Silbante White 2.5	Couvercl Bouillore Siffante White-Black	id For Whistling Kettle White-Black	2,15
68644	R68643A	Asa Hervidor Silbante White 2.5	Poignee Bouillore Siffante White-Black	Handle For Whistling Kettle White-Black	4,25
68644	R68643B	Tapa Hervidor Silbante White 2.5	Couvercl Bouillore Siffante White-Black	id For Whistling Kettle White-Black	2,15
62483	R62483A	Tapa Jarra Termo 1   Blanco/Negro	Couvercle Thermi. Cruche Noir/Blanc 1	id For Thermo Jug White/Black 1	2,75
62484	R62483A	Tapa Jarra Termo 1   Blanco/Negro	Couvercle Thermi. Cruche Noir/Blanc 1	id For Thermo Jug White/Black 1	2,75
64457	R64457A	Set 6 Boquillas De Decoración Para 64457	6 Decorer Buses Set Pour 64457	6 Decorating Nozzles Set For 64457	1,85
69383	R69383A	Juego De Varillas Batidoras Para 69383	Jeu De 2 Batteurs Pour 69383	St.Steel Beaters Hooks Set For 69383	7,10
69383	R69383B	Juego De Varillas Amasadoras Para 69383	Jeu De 2 Malaxeurs Pour 69383	St.Steel Dough Hooks Set For 69383	7,10
69380	R69380A	Tapa Completa Para Batidora De Sopa	Haut Pour Soupe Machine 1,7   ts 1350W	id For Soup Maker 1,7   ts 1350W	20,85
69380	R69380B	4 Pies Antideslizantes Para Batidor Sopa	4 Pieds Caoutchouc Soupe Machine 1,7   ts	4 Rubber Feet For Soup Maker 1,7   ts	1,75
69380	R69380C	Jarra + Cuchilla Para Batidora De Sopa	Haut +   ame Pour Soupe Machine 1,7   ts	Jar + Blade For Soup Maker 1,7   ts	61,45
69380	R69380D	Sistema Calentador Para Batidora Sopa	Sisteme Chauffe Soupe Machine 1,7   ts	Heating System Fro Soup Maker 1,7   ts	22,40
69380	R69380E	Cuchillas Para Batidora De Sopa 1,7   ts	ame Pour Soupe Machine 1,7   ts 1350W	Blade For Soup Maker 1,7   ts 1350W	24,60
69380	R69380H	Jarra Para Batidora De Sopa	Haut Pour Soupe Machine 1,7   ts 1350W	Jar For Soup Maker 1,7   ts 1350W	69,80
69380	R69320H	Panel Control Batidora De Sopa 1,7   ts	Panneau Commande Soupe Machine 1,7   ts	Control Panel For Soup Maker 1,7   ts	27,05
69320	R69320A	Pala Recoge Cubitos Maquina De Hielo Pro	Glace Glaçons Pelle Pour 69320	Ice Cubes Scoop For 69320	1,55
69320	R69320B	Tuberia Suminist. Agua Maquina Hielo Pro	Eau Tuyau D Approvisionnement Pour 69320	Water Supply Pipe For 69320	11,90
69320	R69320C	Switch On Offpara Maquina Hielos Pro	Interrupteur On Off 69320	Switch On Off For 69320	3,55
69320	R69320D	Puerta Para Maquina De Hielo Pro	Porte Pour 69320	Door For 69320	17,30
69320	R69320E	Valvula Entra Agua Maquina Hielo Pro	Entrée D Eau Robinet Pour 69320	Water Inlet Valve For 69320	16,60
69320	R69320F	Placa De Control Para Maquina Hielo Pro	Panneau De Controle Para 69320	Control Board For 69320	51,10
69320	R69320G	Compresor Para Maquina De Hielos Pro	Compresseur Pour 69320	Compressor For 69320	130,45
69320	R69320H	Condensador Maquina De Hielo Pro	Coupe Pour 69320	Condensator For 69320	43,25
69320	R69320J	Ventilador Para Maquina De Hielo Pro	Ventilateur Pour 69320	Fan For 69320	51,40
69161	R69161A	Recetario Thermochef Club Natura Francia	ivre Recette Francais Thermochef Natura	Thermochef Clubnatura French Recipe Book	81,40

Ref.	Repuesto	Descripción	Description	Description	€
69161	R69161C	Tapa Jarra Thermochef	Couvercle Bol Thermochef	Thermochef Jug lid	10,20
69161	R69161D	Paleta Mezcladora Thermochef	Mélangeur Thermochef	Thermochef Mixing Trowel	2,55
69161	R69161E	Espatula Completa Thermochef	Statule Complète	Thermochef Complete Spatula	5,10
69475	R69475A	Tapa Completa Para Airpot Electrico 5,2l	Couverture Pour 69475	lid For 69475	17,30
69475	R69475B	Grifo Para Airpot Electrico 5,2l	Robinet Pour 69475	Faucet For 69475	8,75
69475	R69475C	Bandeja Goteo Airpot Electrico 5,2l	Bac D Egouttage Pour 69475	Drip Tray For 69475	4,25
69475	R69475D	Placa D Control Airpot Electrico 5,2l	Panneau De Commande Pour 69475	Pcboard For 69475	32,35
69475	R69475E	Termostato Airpot Electrico 5,2l	Thermostat Pour 69475	Thermostat For 69475	2,15
69475	R69475F	Asa lateral airpor 5.2 l	Poignee laterale pour 69475	Side handle for 69475	5,30
69283	R69283A	Filtro + Protec. Salpicadura Para 69283	Filtre + Couvercle Eclaboussures 69283	Filter + Protector lid For 69283	16,90
69283	R69283B	Cono Exprimidor Electrico Inox 230 W	Cone Presse-Fruits Electrique Inox 230W	Cone For Juice Squeezer St. Steel 230W	19,75
69283	R69283C	Contenedor De Zumo Para 69283	Cueilleur i es Fruits Pour 69283	Juice Container For 69283	31,15
69283	R69283D	Palanca Exprimidor Elect.Inox 230 W	Poussoir Presse-Fruits Elec. Inox 230W	lever For Juice Squeezer St. Steel 230W	75,30
69283	R69283E	Tapa + Cono Empujador Para 69283	Haut + Poussoir Cone Pour 69283	lid + Pusher Cone For 69283	27,35
69283	R69283F	Set 4 Patas Para Exprimidor 69283	Set 4 Etape De Base Pour 69283	4 Rubberfeet Set For Orange Juicer 69283	4,25
69283	R69283G	Interruptor On/Off Para Exprimidor 69283	On/Off Interrupteur Pour 69283	On/Off Switch For Juicer 69283	3,35
69260	R69260A	Pomo De Palanca Accionadora Para 69260	Pommeau Grille-Pain Doubl Rainure i ongue	lever Knob Double i ong Grovee Toaster	4,25
69260	R69260B	Bandeja Recogemi. Tost. Ranura i arg Dobl	Plateau Ramasse-Miettes Pour 69260	Crumbs Tray Double i ong Grovee Toaster	2,85
68504	R68504A	Cabezal Sifón Crema Green&Black	Tête Complète Pour Siphon Green & Black	Green & Black Cream Whipper Spare Head	20,45
68504	R68504B	Jgo Boquillas Sifón Crema Green&Black	Ensemble Embouts Siphon Green & Black	Green & Black Spare Nozzles Set	5,00
68504	R68504C	Junta Sifon Green&Black	Joint Silicone Pour Siphon G-B Chantilly	Silicone Joint For G-B Cream Whipper	1,55
68504	R68504D	Cabezal Sifón Crema Green&Black	Tête Complète Pour Siphon Green & Black	Green & Black Cream Whipper Spare Head	20,45
68504	R68504E	Jgo Boquillas Sifón Crema Green&Black	Ensemble Embouts Siphon Green & Black	Green & Black Spare Nozzles Set	5,00
68504	R68504F	Junta Sifon Green&Black	Joint Silicone Pour Siphon G-B Chantilly	Silicone Joint For G-B Cream Whipper	1,55
68604	R68504A	Cabezal Sifón Crema Green&Black	Tête Complète Pour Siphon Green & Black	Green & Black Cream Whipper Spare Head	20,45
68604	R68504B	Jgo Boquillas Sifón Crema Green&Black	Ensemble Embouts Siphon Green & Black	Green & Black Spare Nozzles Set	5,00
68604	R68504C	Junta Sifon Green&Black	Joint Silicone Pour Siphon G-B Chantilly	Silicone Joint For G-B Cream Whipper	1,55
68604	R68504D	Cabezal Sifón Crema Green&Black	Tête Complète Pour Siphon Green & Black	Green & Black Cream Whipper Spare Head	20,45
68604	R68504E	Jgo Boquillas Sifón Crema Green&Black	Ensemble Embouts Siphon Green & Black	Green & Black Spare Nozzles Set	5,00
68604	R68504F	Junta Sifon Green&Black	Joint Silicone Pour Siphon G-B Chantilly	Silicone Joint For G-B Cream Whipper	1,55
60390	R60390A	Cabezal Repuesto Maq.i aminad.Pasta 145Mm	Tête Pièce Détachée Machine À Pâte 145Mm	145 Mm Pasta Machine Slicer Spare Head	16,40
60390	R60390B	Manivela+Brida Maq.i aminad.Pasta 145 Mm	Manivelle+Bride P/Machine À Pâte 145Mm	145 Mm Pasta Mach.Slicer i ever+Bracket	5,10
60390	R60390C	Rodillo Cortador Maq.i aminad.Pasta 145Mm	Rouleau Coupeur P/Machine À Pâte 145Mm	145 Mm Pasta Mach.Slicer 2 Wheel Cutter	2,45
61741	R61741A	Tapa Pilas Para Bascula De Baño 61741	Batterie Couvercle Pour Bain Pese 61741	Battery lid For Bathroom Scale 61741	0,70
61741	R61741B	Set 4 Pies De Goma Bascula De Baño 61741	4 Pieds Caoutchouc Pour Bain Pese 200 Kg	Set 4 Rubber Feet Bathroom Scale 61741	0,95
62471	R62471A	Tapon Salero Pimentero "White"	Bouchon Set Salière Et Poivriere "White"	Salt & Papper Cruet Set Cap "White"	1,55
69309	R69309A	Tube T Para 69309	T Tube Pour 69309	T Tube For 69309	2,65
69309	R69309B	Cuchilla Para 69309	ame Pour 69309	Blade For 69309	5,30
69309	R69309C	Empujador Fruta Para 69309	Fruits Poussoir Pour 69309	Fruit Pusher For 69309	1,85
69309	R69309D	Boquilla Para Helado Para 69309	Buse Pour i a Creme Pour 69309	Ice Cream Nozzle For 69309	2,75
69309	R69309E	Interruptor On/Off Para 69309	On/Off Interrupteur Pour 69309	On/Off Switch For 69309	1,75
69309	R69309F	Pies De Goma Para 69309	Pieds En Caoutchouc Pour 69309	Rubber Feets For 69309	1,20
69183	R69183A	Varilla Batidor Batidora-Amasadora 1200W	Fouet Batteur Mixeur-Pétrisseur 1200 W.	Rod Blender Blender-Kneader 1200 W.	5,80
69183	R69183B	Varilla Mezcladora Batidora-Amas. 1200W.	Fouet Mélangeur Mixeur Pétriss. 1200 W.	Mixer Rod Blender-Kneader 1200 W.	6,20
69183	R69183C	Varilla Amasadora Batidora-Amas. 1200 W	Fouet Pétrisseur Mixeur Pétriss. 1200 W	Kneader Blender Rod Kneader 1200 W.	6,20
69183	R69183D	Bol Inox 6 l Batidora-Amasadora 1200 W	Bol Inox 6 l Mixeur-Pétrisseur 1200 W	6 l St. Steel Bowl For 1200 W Mixer	33,50
69183	R69183E	Protector Anti-Salpicaduras Para 69184	Éclaboussure Protecteur Pour 69184	Splash Protector For 69184	1,10
69183	R69183F	Tapa Anti-Salpicaduras Para Bol 6 l	Couvercle Anti Enclaboussures Pourbol 6l	Splash Cover For Bowl 6 l	4,60
69183	R69183G	Set 6 Patas Para 69184	Set 6 Pieds De Silicone Pour 69184	6 Rubber Feet Set For 69184	4,25
69183	R69183H	Muelles Apertura Tapa Batid. Amasad. 6l	Printemps Ouverture De Couverture 69184	Cover Springs For 69184	16,90
69183	R69183I	Placa Control Batidora Amasadora 6l 1200W	Tableau Commande Principal Para 69184	Main Control Board For 69184	24,00
69183	R69183K	Set Engranajes Eje Giratorio Para 69184	Engrenage A Axes Set Pour 69184	Axis Gear Set For 69184	18,30
69183	R69183l	Base Para Jarra De Batid. Amas. 6l 1200W	Aide De Base Pour 69184	Bowl Support Base Pour 69184	5,00
69198	R69198A	Tapa Freidora Electrica 1 l ts 840W	Haut Pour Friteuse Elec. 1 l ts 840W	lid For Electric Fryer 1 l ts 840W	3,35
69198	R69198B	Filtro Freidora Electrica 1 l ts 840W	Filtre Pour Friteuse Elec. 1 l ts 840W	Filter For Electric Fryer 1 l ts 840W	7,45
69198	R69198C	Regulador Temperatura Freidora Elec. 1 l	Temperature Controleur Pour 69198	Thermostat For Electric Fryer 1 l ts 840W	7,10
69198	R69198D	Cestillo Para Freidora Electrica 1 l ts	Panier Friteuse Electrique 1 l t 840W	Frying Basket For Electric Fryer 1 l t	9,00
69199	R69199A	Tapa Freidora Electrica 2.5 l ts 2800W	Haut Pour Friteuse Elec. 2.5 l ts 2800W	lid For Electric Fryer 2.5 l ts 2800W	4,15
69199	R69199B	Cestillo Para Freidora Electrica 2.5 l ts	Panier Friteuse Electrique 2.5 l t 2500W	Frying Basket For Electric Fryer 2.5 l t	10,30
69199	R69199C	Conj. Calentador Freidora Elec. 2.5 l t	Esem. Chauffant Friteuse Elec. 2.5 l t	Heating Set For Electric Fryer 2.5 l ts	28,70
69199	R69199D	Cubeta Freidora Electrica 2.5 l ts 2500W	Huile Bac Pour Friteuse Electrique 2.5 l	Oil Conatiner Electric Fryer 2.5 l ts	15,65
69311	R69311A	Cestillo-Regilla Freidora De Aire 1500W	Grille-Panier Friteuse Airfryer 1500W	Grill-Basket For Air Fryer 1500W 2 l ts	18,40
69311	R69311B	Cubeta Freidora De Aire 1500W 2l ts	Panier Pour Friteuse Airfryer 1500W 2l ts	Frying Bac For Elec.Air Fryer 1500W 2 l t	30,75
69311	R69311C	Mango Freidora De Aire 1500W 2l ts	Poignée Pour Friteuse Airfryer 1500W2l ts	Basket Handle For Air Fryer 1500W 2 l t	4,05
69311	R69311D	Resistencia Freidora De Aire 1500W 2l ts	Résistance Pour Friteuse Airfryer 1500W	Heating Resistance Air Fryer 1500W 2 l ts	8,15
69311	R69311E	Temporizador Freidora De Aire 1500W 2l ts	Minuteur Pour Friteuse Airfryer 1500W	Timer+Knob For Air Fryer 1500W 2 l ts	4,05
69311	R69311F	Pies Goma 4 Freidora De Aire 1500W 2l ts	Pied 4 Pcs Pour Friteuse Airfryer 1500W	Rubber Feet 4 For Air Fryer 1500W 2 l ts	2,25
69267	R69267A	Tapa Para Olla Electrica Sopa 11 l 900W	Haut Pour Pot Soupe Electrique 11 l 800W	lid For Electric Soup Kettle 11 l ts 800W	24,50
69267	R69267B	Regulador De Temperatura Para 69267	Regulateur De Temperature Para 69267	Temperature Regulator For 69267	20,45
69267	R69267C	Cubeta 11 l ts Para Olla Elect.Sopa 69267	Recipient Pot Soupe Electrique 11 l 800W	Pot For Electric Soup Kettle 11 l ts 800W	65,55
69267	R69267D	Set 4 Pies Olla Sopa Electrcia 11 l 900W	Set 4 Pieds Pour 69267	Set 4 Rubber Foots For 69267	24,50
69267	R69267E	Resistencias Calentadoras Para 69267	Element De Chauffage Pour 69267	Heating Element Fur 69267	49,15
69473	R69473A	Placa De Control Airpot Electrico 3.5 l	Plaque Control Pour 69473	Control Card For 69473	7,65
69473	R69473B	Base Giratoria Airpot Electrico 3.5 l	Base Pivotante Pour 69473	Rotating Base For 69473	2,05
69473	R69473C	Tapa Completa Para Airpot Electrico 3,5l	Couverture Pour 69473	lid For 69473	13,95
69473	R69473D	Asa Para Airpot Electrico 3,5/4,5 l	3,5/4,5 l Électrique Airpot Anje	Handle For Electric Air Pot 3,5/4,5 l	1,20
69473	R69473E	Panel De Control Par Airpot 3,5/4,5 l	Plaque Control Élect. Airpot 3,5/4,5 l	Control Panel For Elec. Airpot 3,5/4,5l	4,90
69473	R69473F	Cable Potencia Airpot Elect. 3,5/4,5 l	Câble Puissance Elect. Airpot 3,5/4,5 l	Power Cord For Elect. Airpot 3,5/4,5 l	5,40
69474	R69473A	Placa De Control Airpot Electrico 3.5 l	Plaque Control Pour 69473	Control Card For 69473	7,65
69474	R69473B	Base Giratoria Airpot Electrico 3.5 l	Base Pivotante Pour 69473	Rotating Base For 69473	2,05
69474	R69473C	Tapa Completa Para Airpot Electrico 3,5l	Couverture Pour 69473	lid For 69473	13,95
69474	R69473D	Asa Para Airpot Electrico 3,5/4,5 l	3,5/4,5 l Électrique Airpot Anje	Handle For Electric Air Pot 3,5/4,5 l	1,20
69474	R69473E	Panel De Control Par Airpot 3,5/4,5 l	Plaque Control Élect. Airpot 3,5/4,5 l	Control Panel For Elec. Airpot 3,5/4,5l	4,90
69474	R69473F	Cable Potencia Airpot Elect. 3,5/4,5 l	Câble Puissance Elect. Airpot 3,5/4,5 l	Power Cord For Elect. Airpot 3,5/4,5 l	5,40
69278	R69278A	Filtro Cafetera De Goteo 1,25 l	Filtre Pour Café Filtre 1,25 l	Filter For Coffee Machine 1,25 l	1,20

Ref.	Repuesto	Descripción	Description	Description	€
69278	R69278B	Contenedor Cafe Cafetera De Goteo 1,25 l	Recipient A Cafe Pour Café Filtre 1,25 l	Coffee Container Coffee Machine 1,25 l	5,20
69278	R69278C	Jarra Para Cafetera De Goteo 1,25 l	Pichet Pour Café Filtre 1,25 l	Jar For Coffee Machine 1,25 l	7,35
69279	R69279A	Filtro Cafetera Goteo Programable 1,5 l	Filtre Programables Café Filtre 1,8 l	Filter For Progr. Filt. Coffee Mach 1,8l	1,20
69279	R69279B	Contenedor Cafe Cafet. Goteo Progr 1,5 l	Recipient A Cafe Pour Café Filtre 69279	Coffee Container Coffee Machine 69279	5,20
69279	R69279C	Jarra Para Cafetera Goteo Progr. 1,5 l	Pichet Pour Programa. Café Filtre 1,8 l	Jar For Progr. Filt.Coffee Machine 1,8 l	7,35
69292	R69292A	Jarra Cristal Completa Para 69292	Pot En Verre Por l a Bouilloire 69292	Glass Jug For Kettle 69292	45,20
69292	R69292B	Base Para Hervidor De Cristal 69292	Base Por l a Bouilloire 69292	Base For Glass Kettle 69292	25,05
69292	R69292C	Filtro Para Hervidor De Cristal 69292	Filtre Pour l a Bouilloire 69292	Filter For Glass Kettle 69292	4,25
69293	R69293A	Tapa Sin Filtro Para Hervior Elec. 69293	Couvercle Non Filtre Pour 69293	lid Without Filter For Elec.Kettle 69293	23,70
69293	R69293B	Tapa Con Filtro Para Hervior Elec. 69293	Couvercle Avec Filtre Pour 69293	lid With Filter For Elec.Kettle 69293	32,35
69293	R69293C	Base Conectora Para Hervior Elec. 69293	Connecteur De Base Pour 69293	Base Connector For Elec.Kettle 69293	26,25
69293	R69293D	Jarra Cristal Para Hervior Elec. 69293	Bocal En Berre Pour 69293	Glass Jar For Elec.Kettle 69293	51,80
69391	R69061A	l ampara Infrarrojos 275 W	l ampe Infrarouge 275 W	275 W Infrared Heating Bulb	7,85
69391	R69061B	Set Repuestos 69061	Pièces Set Pour 69061	Spare Part Set For 69061	5,80
69390	R69390A	Bandeja Recogemigas Tostadora Home	Ramasse Miettes Pour 69390	Crumb Tray For Electric Toaster 1080 W	7,10
69390	R69390B	Palanca De Tostadora Home 1080 W	l evier Pour 69390	l ever For Electric Toaster 69390	1,10
69390	R69390C	Botones + Placa Control Tostadora 69390	Boutons De Commande + Pcb Pour 69390	Control Buttons + Control Pcb For 69390	13,75
69390	R69390D	Set 4 Patas Para Tostadora Home 1080 W	Set 4 Pieds Pour 69390	4 Feet Set For Electric Toaster 69390	1,10
69287	R69287A	Tapa Para Exprimidor De Naranjas 69287	Couvercle Pour 69287	lid For 69287 Orange Juicer	4,25
69287	R69287B	Set 4 Pies Goma Para Exprimidor 69287	4 Pieds Caoutchouc Pour 69287	4 Rubber Feet Set For 69287 Juicer	2,85
69287	R69285A	Cono + Inserto Exprimidor 85W	Presse Pour Presse-Fruits 85W	Plastic Cone+Insert Elec.Orange Sque.85W	7,75
69287	R69285B	Bandeja Filtro Exprimidor C/Brazo 85 W	Filtre Pour Presse Fruits Electrique 85W	85W St.St Filter Tray Elec.Orange Squeez.	14,05
69287	R69285E	Repuestos Varios Para 69285	Pièces Détachées Pour 69285	Spare Parts For 69285	5,60
69393	R69393A	Filtros Cafetera "Tempo" 1.25l	Filtre Machine À Café Autom."Tempo"1.25l	Filters Coffee Machine "Tempo" 1.25 l	2,15
69393	R69393B	Jarra Cristal Cafetera "Tempo" 1.25l	Pichet Machine À Café Autom."Tempo"1.25l	Glass Jug Coffee Machine "Tempo" 1.25 l	4,15
69393	R69393C	Juntas Cafetera "Tempo" 1.25l	Joint Sil.Machine Café Autom."Tempo"1.25	Gaskets Coffee Machine "Tempo" 1.25 l	1,75
69392	R69392A	Base Hervidor De Agua "Tempo" 1,7l	Base Bouilloire Électrique "Tempo" 1.7 l	Kettle Heater Plaque "Tempo" 1,7l	10,30
69391	R69391A	Bandeja Recogemigas Tostadora Tempo 870W	Plaque À Ramasse-Miettes Grille-Pain Tem	Crumbs Tray Toaster "Tempo" 870W	2,15
69394	R69394A	Conos Repuesto Exprimidor "Tempo" 1.2 l	Presse Pour Presse-Fruits "Tempo" 1.2 l	Spare Cones Orange Squeezer "Tempo" 1.2l	2,15
69394	R69394B	Filtro+Tapa Exprimidor "Tempo" 1.2 l	Filtre+Couve.Presse-Fruits "Tempo" 1.2 l	Filter+l id Orange Squeezer "Tempo" 1.2l	3,35
69350	R69350A	Set De Sellado Maquina Vacio Maxi 110 W	Set Etancheite Souds Visde Maxi 110 W	Welding Set For110 W Maxi Vacuum Machine	4,15
69350	R69350B	Botones Apertura Tapa Para 69350	Goupille Ouverture Couverde Pour 69350	lid Open Buttons For 69350	2,15
69350	R69350C	Elemento Cortador Para Maq. Vacio Maxi	Coupeur Pour Souds Visde Maxi 110 W	Cutter For Maxi Vacuum Machine 110W	6,20
69350	R69350D	Placa Control Maquina Vacio Maxi 110 W	Panneau Commande Souds Visde Maxi 110 W	Pcboard For110 W Maxi Vacuum Machine	57,30
69350	R69350E	Bomba Vacio Maquina Vacio Maxi 110 W	Pompe A Vide Souds Visde Maxi 110 W	Vacuum Pump For110 W Maxi Vacuum Machine	30,75
69430	R69430A	Tapa Para Maquina De Vacio Profesional	Couvercle Pour Mach. Sous Vide Profess.	lid For Professional Vacuum Machine	65,30
69430	R69430B	De De Sellado Para 69430	Mastic Silicone Pour 69430	Seal Silicon For 69430	13,15
69430	R69430C	Almohadilla De Vacio + Filtro Para 69430	Coussin Vide + Filtre Pour 69430	Vacuum Foam + Filter For 69430	13,15
69430	R69430D	Bandeja l iquido Para 69430	Bac A l iquide Pour 69430	l iquid Tray For 69430	19,65
69430	R69430E	Tubo Canister Para 69430	Canister Tube Pour 69430	Canister Tube For 69430	5,30
69430	R69430F	Cable De Potencia Para 69430	Cordon D Alimentation Pour 69430	Power Cord For 69430	17,70
69430	R69430G	Set 4 Patas Maquina De Vacio Profesional	4 Pieds En Caoutchouc Pour 69430	4 Rubber Feet Professional Vacuum Machine	15,85
69430	R69430H	Cuchilla Bolsas Para 69430	Sac Coupe Pour 69430	Bag Cutter For 69430	8,95
69430	R69430J	Barra De Sellado Para Maquina 69430	Barre De Soudure Para 69430	Sela Bar For Vacuum Machine 69430	51,30
69116	R69116A	Barra De Sellado Maquina Vacio 69116	Barre De Soudure Machine A Vide 69116	Sealing Bar For Vacuum Machine 69116	27,90
69116	R69116B	Almohadil De Sellado Maquina Vacio 69116	Tampon De Soudure Machine A Vide 69116	Sealing Pad For Vacuum Machine 69116	3,85
69116	R69116C	Sistema Amarre Bolsa Maqui. Vacio 69116	Systeme Retenue Sac Machine A Vide 69116	Bag Holding System Vacuum Machine 69116	7,45
69116	R69116D	Bisagra Tapa Maquina Vacio 69116	Charnieres Couvercl Machine A Vide 69116	lid Hinges For Vacuum Machine 69116	2,15
69116	R69116E	Panel De Control Maquina Vacio 69116	Panneau Commande Machine A Vide 69116	Control Panel For Vacuum Machine 69116	50,35
69116	R69116F	Set 4 Pies De Goma Maquina Vacio 69116	4 Pieds En Caoutchouc Machine Vide 69116	4 Rubber Feet For Vacuum Machine 69116	3,15
69116	R69116G	Placa De Control Maquina Vacio 69116	Carte Principale Machine A Vide 69116	Pcboard For Vacuum Machine 69116	47,00
69116	R69116H	Aro De Sellado Maquina Vacio 69116	Bague D Etancheite Machine A Vide 69116	Sealing Ring For Vacuum Machine 69116	6,70
69116	R69116J	Tapa Completa Maquina Vacio 69116	Couvercle Machine A Vide 69116	lid For Vacuum Machine 69116	162,90
69184	R69184A	Placa De Control l ado Izqui. Para 69184	Panneau Controle A Gauche Pour 69184	l eft Side Contol Board For 69184	5,80
69184	R69184B	Bloque Enfriador Para Armario 69184	Bloc Refroidisseur Pour 69184	Cooling System For 69184	83,45
69184	R69184C	Tarjeta Control Temp. Izquie. Para 69184	Gauche Temperature Carte Pour 69184	l eft Temp. Control Board For 69184	6,20
69184	R69184D	Ventilador De Aire Frio Para 69184	Ventilateur Refroidissement Pour 69184	Cool Air Fan For 69184	33,90
69184	R69184E	Ventilador De Aire Caliente Para 69184	Soufflerie D Air Chaud Para 69184	Hot Air Fan For 69184	16,30
69184	R69184F	Pasamanos Armario Refrigerador 69184	Poignee Refroidis A Vin Electr. 69184	Handlebar For Wine Cellar 69184	4,70
69184	R69184G	Filtro Para Armario Refrigerado 69184	Filtre Pour 69184	Filter For Wine Cellar 69184	3,95
69184	R69184H	Placa Control l ado Derec. Para 69184	Panneau Controle A Droit Pour 69184	Right Side Contol Board For 69184	0,60
69184	R69184J	Parrilla 3 Botellas Armario Refri. 69184	3 Bou. Grill Pour Refr. Vin Elec. 69184	3 Bottles Grill For 69184 Wine Cellar	24,20
69184	R69184K	Tarjeta Control Temp. Derecha Para 69184	Droit Temperature Carte Pour 69184	Right Temp. Control Board For 69184	18,40
39133	R39133A	Recipiente Mosquitos Para 39133	Recipient A Moustiques Pour 39133	Mosquito Conatiner For 39133	6,50
39133	R39133B	Bombilla Ultravioleta 13W	Ampoule Uv 13W	13W Ultraviolet l amp	8,75
39133	R39133C	Interruptor Mata Mosquitos Electrico 13W	Interrupteur Pour 39133	Switch For Electric Mosquito Killer 13W	2,35
39133	R39133D	Ventilador Mata Mosquitos Electr.39133	Ventilateur Pour 39133	Fan For Mosquito Killer 13W	0,50



**Índice**



**Sommaire**



**Index**



**Index**



**Índice**



Ref	Pag	Ref	Pag	Ref	Pag	Ref	Pag	Ref	Pag
00722	443	20031	24	20555A	26	21224	25	23818	68
00723	443	20032	24	20555A	81	21226	25	23820	68
00724	443	20033	24	20555F	26	21228	25	23822	68
00725	444	20034	24	20555F	81	21618	68	23824	68
10004	303	20035	24	20560A	26	21620	68	23826	68
10025	444	20036	24	20560A	81	21622	68	23828	68
10026	444	20037	24	20560F	26	21624	68	23830	70
10027	444	20038	24	20560F	81	21626	68	23832	68
10330	304	20039	24	20561	26	21628	68	23836	68
10430	304	20040	24	20565A	26	21632	68	23840	68
11330	304	20041	24	20565A	81	21636	68	24120	72
11430	304	20045	24	20565F	26	21640	68	24122	72
12406	339	20046	24	20565F	81	21718	67	24123	72
12407	339	20050	24	20570A	26	21720	67	24124	72
12408	339	20051	24	20570A	81	21722	67	24125	72
14012	174	20055	24	20570F	26	21724	67	24126	72
14013	177	20056	24	20570F	81	21726	67	24127	72
14016	112	20060	24	20615	63	21728	67	24128	72
14016	309	20061	24	20618	63	21732	67	24129	72
14019	112	20120	25	20628	25	21736	67	24134	73
14019	309	20124	25	20628	88	22718	67	24135	73
14025	112	20126	25	20630	25	22720	67	24136	72
14025	309	20128	25	20630	88	22722	67	24137	72
14027	139	20130	25	20632	25	22724	67	24138	72
14029	112	20132	25	20632	88	22726	67	24720	75
14029	309	20134	25	20634	25	22728	67	24722	75
14033	112	20136	25	20634	88	22732	67	24724	75
14033	309	20138	25	20636	25	22736	67	24726	75
14042	139	20140	25	20636	88	23322	71	24728	75
14050	139	20145	25	20638	25	23323	71	24732	75
14065	177	20150	25	20638	88	23326	71	24820	75
14100	139	20155	25	20640	25	23327	71	24822	75
14114	112	20160	25	20640	88	23330	71	24824	75
14119	112	20216	25	20645	25	23416	68	24826	75
14121	194	20217	25	20645	88	23418	68	24828	75
14122	113	20218	25	20650	25	23420	68	24832	75
14124	112	20219	25	20650	88	23422	68	24918	75
14125	113	20220	25	20655	25	23424	68	24920	75
14128	112	20221	25	20655	88	23426	68	24922	75
14130	113	20222	25	20660	25	23428	68	24924	75
14135	139	20223	25	20660	88	23432	68	24926	75
14136	139	20224	25	20716	25	23436	68	24928	75
14145	139	20225	25	20718	25	23540A	81	25120	74
14205	48	20226	25	20720	25	23550A	81	25122	74
14212	48	20227	25	20830	62	23612	70	25124	74
14214	48	20228	25	20840	62	23614	70	25126	74
14216	48	20229	25	20850	62	23616	68	25128	74
14218	48	20337	26	20920	26	23618	68	25132	88
14220	48	20341	26	20924	26	23620	68	25136	88
14318	48	20470	26	20926	26	23622	68	25140	88
14320	48	20518	63	20928	26	23624	68	25523	74
14322	48	20522	63	20930	26	23626	68	25525	74
14324	48	20540A	26	20932	26	23628	68	25527	74
14420	48	20540A	81	20934	26	23632	68	25529	74
14422	48	20540F	26	20936	26	23636	68	25534	80
14424	48	20540F	81	20938	26	23637	71	25536	73
20020	24	20545A	26	20940	26	23638	71	25539	80
20021	24	20545A	81	20945	26	23640	68	25547	73
20024	24	20545F	26	20950	26	23641	71	25771	56
20025	24	20545F	81	20955	26	23724	88	25771	170
20026	24	20550A	26	20960	26	23728	88	25772	56
20027	24	20550A	81	21216	25	23732	88	25772	170
20028	24	20550F	26	21218	25	23736	88	25773	56
20029	24	20550F	81	21220	25	23740	88	25773	170
20030	24	20551	26	21222	25	23816	68	25781	56

Ref	Pag	Ref	Pag	Ref	Pag	Ref	Pag	Ref	Pag
25781	170	25931	54	28131	214	32016	41	39008	242
25782	56	25933	54	28132	214	32020	41	39009	242
25782	170	25935	54	28133	214	32024	41	39010	241
25783	56	R25935C	55	28141	210	32028	41	39012	434
25783	170	R25935C	85	28151	217	32116	41	39014	240
25815	51	R25935G	55	28161	218	32120	41	39015	241
25816	51	R25935G	85	28172	218	32124	41	39016	240
25817	51	27320	52	28182	218	32125	41	39017	241
25820	51	27324	52	28191	206	32128	41	39020	240
25821	51	27327	52	28192	206	32129	41	39021	240
25823	51	27328	52	28193	206	32214	41	39023	240
25824	51	27416	52	28195	206	32216	41	39024	240
25825	51	27418	52	28196	206	32218	41	39025	240
25827	51	27620	52	28197	206	32220	41	39027	240
25828	51	27620	74	28198	206	32318	41	39028	240
25829	51	27624	52	28199	206	32324	41	39030	240
25830	51	27624	74	28211	214	32420	41	39040	183
25831	51	27625	52	28212	214	32424	41	39041	183
25832	51	27625	74	28213	214	32624	41	39043	102
25835	51	27626	52	28221	214	32628	41	39043	236
25871	56	27626	74	28222	214	32714	41	39044	102
25871	170	27628	52	28223	214	32716	41	39044	236
25872	56	27628	74	28231	215	32916	41	39047	102
25872	170	27629	52	28232	215	32920	41	39047	236
25873	56	27629	74	28233	215	32924	41	39048	102
25873	170	27920	52	28241	215	32928	41	39048	236
25874	57	27924	52	28242	215	33101	249	39060	242
25874	171	27928	52	28243	215	33102	249	39061	242
25875	57	28001	207	28251	215	33103	249	39064	242
25875	171	28002	207	28252	215	33104	249	39065	243
25876	57	28003	207	28253	215	33105	249	39075	238
25876	171	28011	207	28261	216	33106	249	39110	240
25877	57	28012	207	28262	216	33107	249	39112	240
25877	171	28013	207	28263	216	33108	249	39114	240
25881	56	28021	208	28271	216	33109	249	39115	241
25881	170	28022	208	28272	216	33110	249	39116	240
25882	56	28023	208	28273	216	33111	249	39118	240
25882	170	28031	208	28281	216	33112	249	39121	240
25883	56	28032	208	28282	216	33113	249	39124	434
25883	170	28033	208	28283	216	33114	249	39125	240
25909	54	28041	209	28291	217	33115	249	39128	436
25909	169	28051	209	28292	217	33116	249	39133	436
25910	54	28052	209	28293	217	33124	249	39137	436
25910	169	28053	209	28301	217	33125	249	39138	436
25911	54	28061	210	28302	217	33126	249	39139	436
25911	169	28062	210	28303	217	33401	249	39140	203
25912	54	28063	210	28311	219	33402	249	39140	435
25912	169	28071	211	28321	219	33403	249	39160	203
25914	54	28072	211	28500	207	33404	249	39160	435
25914	169	28073	211	28501	207	33405	249	39161	203
25915	54	28081	211	28502	207	33406	249	39161	435
25915	169	28082	211	28510	208	33407	249	39162	202
25916	54	28083	211	28511	208	33408	249	39163	202
25917	54	28091	212	28512	208	33409	249	39164	202
25920	54	28092	212	28520	212	33410	249	39165	237
25921	54	28093	212	28521	212	33411	249	39166	202
R25921C	55	28101	212	28522	212	33412	249	39169	237
R25921C	85	28102	212	28530	209	33413	249	39170	237
R25921G	55	28103	212	28531	209	33414	249	39171	237
R25921G	85	28111	213	28532	209	33415	249	39172	237
25924	54	28112	213	28540	210	33416	249	39185	240
25925	54	28113	213	28550	211	38010	248	39208	238
25927	54	28121	213	28560	213	39000	241	39210	238
25928	54	28122	213	32000	40	39001	241	39212	238
25929	54	28123	213	32003	40	39004	241	39213	238

Ref	Pag	Ref	Pag	Ref	Pag	Ref	Pag	Ref	Pag
39215	238	40918	37	45918	29	50221	20	50636W	87
39218	238	40920	37	45920	29	50224	20	50637	21
39308	238	40922	37	45922	29	50225	20	50640	21
39310	238	40924	37	45924	29	50225N	20	50640	87
39312	238	40926	37	45926	29	50228	20	50640W	87
39313	238	40928	37	45928	29	50229	20	50645	21
39315	238	40932	37	49014	239	50229N	20	50645	87
39318	238	40936	37	49016	239	50300	112	50645W	87
40000	36	40940	37	49017	239	50301	304	50650	21
40016	36	43005	30	49021	239	50320	114	50650	87
40018	36	43016	31	49024	239	50323	111	50650W	87
40020	36	43020	31	49025	239	50323S	111	50660	21
40022	36	43024	31	49027	239	50324	114	50660	87
40024	36	43028	31	49030	239	50327	111	50660W	87
40026	36	43116	31	49110	239	50327S	111	50717	20
40028	36	43120	31	49112	239	50328	114	50721	20
40032	36	43124	31	49116	239	50332	113	50815	61
40036	36	43128	31	49121	239	50333	111	50816	61
40040	36	43214	31	49185	239	50333S	111	50818	61
40116	36	43216	31	49210	239	50334	114	50819	61
40118	36	43218	31	49212	239	50335	114	50823	61
40120	36	43220	31	49216	239	50336	113	50824	61
40121	37	43624	31	50016	19	50337	111	50828	111
40122	36	43628	31	50017	19	50337S	111	50829	113
40124	36	43714	31	50020	19	50338	114	50832	111
40125	37	43716	31	50021	19	50339	114	50833	113
40126	36	44005	30	50024	19	50340	113	50836	111
40128	36	44016	31	50025	19	50341	111	50837	113
40129	37	44020	31	50028	19	50341S	111	50840	111
40132	36	44024	31	50029	19	50428	19	50841	113
40133	37	44028	31	50032	19	50428	112	50845	111
40136	36	44116	31	50033	19	50432	19	50846	113
40140	36	44120	31	50036	19	50432	112	50850	111
40212	37	44124	31	50037	19	50437	112	50851	113
40214	37	44128	31	50040	19	50438	113	50916	21
40216	37	44214	31	50041	19	50440	112	50918	21
40218	37	44216	31	50045	19	50441	112	50920	21
40220	37	44218	31	50046	19	50445	112	50924	21
40318	37	44220	31	50050	19	50450	113	50928	21
40324	37	44624	31	50051	19	50460	112	50932	21
40420	37	44628	31	50060	19	50540	21	50933	61
40424	37	44714	31	50061	19	50540	80	50936	21
40426	37	44716	31	50116	20	50541	113	50940	21
40428	37	45016	28	50119	20	50550	21	50945	21
40619	66	45018	28	50120	20	50550	80	50950	21
40620	37	45020	28	50123	20	50551	113	50960	21
40621	66	45022	28	50124	20	50560	21	51216	20
40622	37	45024	28	50127	20	50560	80	51218	20
40623	66	45026	28	50128	20	50561	113	51220	20
40624	37	45028	28	50131	20	50570	21	51222	20
40625	66	45116	28	50132	20	50570	80	51224	20
40626	37	45118	28	50135	20	50624	21	51620	66
40627	66	45120	28	50136	20	50624	87	51621	66
40628	37	45122	28	50139	20	50624W	87	51624	66
40629	66	45124	28	50140	20	50625	21	51625	66
40632	37	45126	28	50145	20	50628	21	51628	66
40636	37	45128	28	50150	20	50628	87	51629	66
40640	37	45214	29	50160	20	50628W	87	51632	66
40712	37	45216	29	50212	20	50629	21	51633	66
40714	37	45218	29	50214	20	50632	21	51636	66
40716	37	45220	29	50216	20	50632	87	51637	66
40718	37	45624	29	50217	20	50632W	87	51640	66
40912	37	45626	29	50218	20	50633	21	51641	66
40914	37	45628	29	50219	20	50636	21	51720	66
40916	37	45916	29	50220	20	50636	87	51724	66

Ref	Pag	Ref	Pag	Ref	Pag	Ref	Pag	Ref	Pag
51728	66	54046	16	54650	17	55448	291	55513	291
51732	66	54046S	16	54650	87	55449	291	55514	291
51736	66	54050	16	54650S	17	55450	291	55515	291
51740	66	54050S	16	54650S	87	55451	291	55516	291
53016	49	54051	16	54916	18	55452	291	55517	291
53018	49	54051S	16	54920	18	55453	291	55518	291
53020	49	54119	17	54924	18	55454	291	55519	291
53024	49	54119S	17	54928	18	55455	291	55520	292
53214	49	54120	17	54932	18	55456	291	55521	292
53216	49	54120S	17	54932	61	55457	291	55522	292
53218	49	54123	17	54936	18	55458	291	55523	292
53220	49	54123S	17	54940	18	55459	291	55524	292
53625	50	54124	17	54945	18	55460	291	55525	292
53720	50	54124S	17	54950	18	55461	291	55526	292
53720	77	54127	17	55216	18	55462	291	55527	292
53721	50	54127S	17	55220	18	55463	291	55528	292
53721	77	54128	17	55224	18	55464	291	55529	292
53724	50	54128S	17	55400	290	55465	291	55530	292
53724	77	54131	17	55401	290	55466	291	55531	292
53725	50	54131S	17	55402	290	55467	291	55532	292
53725	77	54132	17	55403	290	55468	291	55533	292
53728	50	54132S	17	55404	290	55469	291	55534	292
53728	77	54135	17	55405	290	55470	291	55535	292
53729	50	54135S	17	55406	290	55471	291	55536	292
53729	77	54136	17	55407	290	55472	291	55537	292
53828	50	54136S	17	55408	290	55473	291	55538	292
53828	77	54139	17	55409	291	55474	291	55539	292
53829	50	54139S	17	55410	291	55475	291	55540	292
53829	77	54140	17	55411	291	55476	291	55541	292
53836	262	54140S	17	55412	291	55477	291	55542	292
53836	379	54145	17	55413	291	55478	291	55543	292
53916	50	54145S	17	55414	291	55479	291	55544	292
53916	78	54150	17	55415	291	55480	291	55545	292
53918	50	54150S	17	55416	291	55481	291	55546	292
53918	78	54212	17	55417	291	55482	291	55547	292
53920	50	54214	17	55418	291	55483	291	55548	292
53920	78	54216	17	55419	291	55484	291	55549	292
53924	50	54217	17	55420	291	55485	291	55550	292
53924	78	54218	17	55421	291	55486	291	55551	292
54020	16	54219	17	55422	291	55487	291	55552	292
54020S	16	54220	17	55423	291	55488	291	55553	292
54021	16	54221	17	55424	291	55489	291	55554	292
54021S	16	54224	17	55425	291	55490	291	55555	292
54024	16	54225	17	55426	291	55491	291	55556	292
54024S	16	54225N	18	55427	291	55492	291	55557	292
54025	16	54228	17	55428	291	55493	291	55558	292
54025S	16	54229	17	55429	291	55494	291	55559	292
54028	16	54229N	18	55430	291	55495	291	55560	292
54028S	16	54621	18	55431	291	55496	291	55561	292
54029	16	54625	18	55432	291	55497	291	55562	292
54029S	16	54629	18	55433	291	55498	291	55563	292
54032	16	54633	18	55434	291	55499	291	55564	292
54032S	16	54636	17	55435	291	55500	291	55565	292
54033	16	54636	87	55436	291	55501	291	55566	292
54033S	16	54636S	17	55437	291	55502	291	55567	292
54036	16	54636S	87	55438	291	55503	291	55568	292
54036S	16	54637	18	55439	291	55504	291	55569	292
54037	16	54640	17	55440	291	55505	291	55570	292
54037S	16	54640	87	55441	291	55506	291	55571	292
54040	16	54640S	17	55442	291	55507	291	55572	292
54040S	16	54640S	87	55443	291	55508	291	55573	292
54041	16	54645	17	55444	291	55509	291	55574	292
54041S	16	54645	87	55445	291	55510	291	55575	292
54045	16	54645S	17	55446	291	55511	291	55576	292
54045S	16	54645S	87	55447	291	55512	291	55577	292



Ref	Pag	Ref	Pag	Ref	Pag	Ref	Pag	Ref	Pag
55578	292	55643	295	55723	293	55788	293	55853	294
55579	292	55644	295	55724	293	55789	293	55854	294
55580	292	55645	295	55725	293	55790	293	55855	294
55581	292	55646	295	55726	293	55791	293	55856	294
55582	292	55647	295	55727	293	55792	293	55857	294
55583	292	55648	295	55728	293	55793	293	55858	294
55584	292	55649	295	55729	293	55794	293	55859	294
55585	292	55650	295	55730	293	55795	293	55860	294
55586	292	55651	295	55731	293	55796	293	55861	294
55587	292	55652	295	55732	293	55797	293	55862	294
55588	292	55653	295	55733	293	55798	293	55863	294
55589	292	55654	295	55734	293	55799	293	55864	294
55590	292	55655	295	55735	293	55800	293	55865	294
55591	292	55656	295	55736	293	55801	293	55866	294
55592	292	55657	295	55737	293	55802	293	55867	294
55593	292	55658	295	55738	293	55803	293	55868	294
55594	292	55659	295	55739	293	55804	293	55869	294
55595	292	55660	295	55740	293	55805	293	55870	294
55596	292	55661	295	55741	293	55806	293	55871	294
55597	292	55662	295	55742	293	55807	293	55872	294
55598	292	55663	295	55743	293	55808	293	55873	294
55599	292	55664	295	55744	293	55809	293	55874	294
55600	292	55665	295	55745	293	55810	293	55875	294
55601	292	55666	295	55746	293	55811	293	55876	294
55602	292	55667	295	55747	293	55812	293	55877	294
55603	292	55668	295	55748	293	55813	293	55878	294
55604	292	55669	295	55749	293	55814	293	55879	294
55605	292	55670	295	55750	293	55815	293	55880	294
55606	292	55671	295	55751	293	55816	293	55881	294
55607	292	55672	295	55752	293	55817	293	55882	294
55608	292	55673	295	55753	293	55818	293	55883	294
55609	292	55674	295	55754	293	55819	293	55884	294
55610	292	55675	295	55755	293	55820	294	55885	294
55611	292	55676	295	55756	293	55821	294	55886	294
55612	292	55677	295	55757	293	55822	294	55887	294
55613	292	55678	295	55758	293	55823	294	55888	294
55614	292	55679	295	55759	293	55824	294	55889	294
55615	292	55680	295	55760	293	55825	294	55890	294
55616	292	55681	295	55761	293	55826	294	55891	294
55617	292	55682	295	55762	293	55827	294	55892	294
55618	292	55683	295	55763	293	55828	294	55893	294
55619	292	55684	295	55764	293	55829	294	55894	294
55620	292	55700	290	55765	293	55830	294	55895	294
55621	292	55701	290	55766	293	55831	294	55896	294
55622	292	55702	290	55767	293	55832	294	55897	294
55623	292	55703	290	55768	293	55833	294	55898	294
55624	292	55704	290	55769	293	55834	294	55899	294
55625	292	55705	290	55770	293	55835	294	55900	294
55626	292	55706	290	55771	293	55836	294	55901	294
55627	292	55707	290	55772	293	55837	294	55902	294
55628	292	55708	290	55773	293	55838	294	55903	294
55629	292	55709	293	55774	293	55839	294	55904	294
55630	292	55710	293	55775	293	55840	294	55905	294
55631	295	55711	293	55776	293	55841	294	55906	294
55632	295	55712	293	55777	293	55842	294	55907	294
55633	295	55713	293	55778	293	55843	294	55908	294
55634	295	55714	293	55779	293	55844	294	55909	294
55635	295	55715	293	55780	293	55845	294	55910	294
55636	295	55716	293	55781	293	55846	294	55911	294
55637	295	55717	293	55782	293	55847	294	55912	294
55638	295	55718	293	55783	293	55848	294	55913	294
55639	295	55719	293	55784	293	55849	294	55914	294
55640	295	55720	293	55785	293	55850	294	55915	294
55641	295	55721	293	55786	293	55851	294	55916	294
55642	295	55722	293	55787	293	55852	294	55917	294

Ref	Pag	Ref	Pag	Ref	Pag	Ref	Pag	Ref	Pag
55918	294	55983	296	57120	22	60016	111	60306	92
55919	294	55984	296	57124	22	60016	309	60307	231
55920	294	56007	288	57128	22	60017	85	60308	92
55921	294	56008	288	57132	22	60018	248	60309	92
55922	294	56009	288	57136	22	60019	248	60310	92
55923	294	56010	288	57140	22	60020	111	60311	114
55924	294	56011	288	57212	23	60020	309	60312	92
55925	294	56012	288	57214	23	60021	116	60313	114
55926	294	56013	288	57216	23	60022	248	60314	92
55927	294	56014	288	57217	23	60023	248	60315	114
55928	294	56015	288	57218	23	60024	111	60316	92
55929	294	56212	283	57219	23	60024	309	60316P	114
55930	294	56216	283	57220	23	60026	116	60316V	114
55931	296	56302	288	57221	23	60027	116	60317	114
55932	296	56317	288	57224	23	60028	111	60318	114
55933	296	56320	288	57225	23	60028	309	60318P	114
55934	296	56321	289	57302	288	60030	116	60319	114
55935	296	56322	289	57317	288	60031	116	60319V	114
55936	296	56325	289	57320	288	60032	111	60320	114
55937	296	56330	288	57321	289	60032	309	60320P	114
55938	296	56412	283	57322	289	60034	85	60321	114
55939	296	56416	283	57325	289	60036	111	60322	114
55940	296	56435	289	57330	288	60036	309	60322P	114
55941	296	56502	289	57435	289	60040	111	60323	114
55942	296	56507	289	57624	22	60040	309	60324	114
55943	296	56508	289	57624	87	60048	116	60324P	114
55944	296	56509	289	57625	23	60052	85	60325	114
55945	296	56510	289	57628	22	60059	248	60326	114
55946	296	56511	289	57628	87	60060	248	60327	197
55947	296	56512	289	57629	23	60061	248	60328	226
55948	296	56513	289	57632	22	60062	84	60329	118
55949	296	56514	289	57632	87	60068	84	60331	232
55950	296	56515	289	57636	22	60070	85	60332	233
55951	296	56517	289	57636	87	60072	245	60334	118
55952	296	56520	289	57640	22	60127	89	60335	118
55953	296	56522	288	57640	87	60130	87	60336	228
55954	296	56523	288	57717	23	60131	89	60340	118
55955	296	56524	289	57721	23	60134	87	60343	235
55956	296	56525	289	57916	23	60135	89	60346	224
55957	296	56526	289	57920	23	60138	87	60347	224
55958	296	56527	289	57924	23	60139	89	60348	112
55959	296	57007	288	57928	23	60141	89	60349	112
55960	296	57008	288	57932	23	60142	87	60350	227
55961	296	57009	288	57936	23	60144	89	60351	224
55962	296	57010	288	57940	23	60146	87	60352	224
55963	296	57011	288	58012	185	60149	89	60353	224
55964	296	57012	288	58025	185	60150	87	60354	224
55965	296	57013	288	58060	185	60151	89	60356	232
55966	296	57014	288	58090	185	60155	87	60357	233
55967	296	57015	288	60000	228	60159	89	60358	228
55968	296	57016	22	60001	248	60160	87	60359	243
55969	296	57017	22	60002	92	60161	89	60359	434
55970	296	57020	22	60003	92	60224	87	60365	226
55971	296	57021	22	60004	228	60228	87	60366	222
55972	296	57024	22	60005	228	60232	87	60367	222
55973	296	57025	22	60006	337	60236	87	60368	222
55974	296	57028	22	60007	337	60240	87	60369	222
55975	296	57029	22	60008	337	60245	87	60372	222
55976	296	57032	22	60009	228	60250	87	60377	222
55977	296	57033	22	60010	85	60298	227	60378	222
55978	296	57036	22	60011	85	60300	115	60380	222
55979	296	57037	22	60012	85	60301	229	60381	222
55980	296	57040	22	60013	111	60302	229	60385	123
55981	296	57041	22	60013	309	60303	229	60386	242
55982	296	57116	22	60014	85	60305	231	60387	117

Ref	Pag	Ref	Pag	Ref	Pag	Ref	Pag	Ref	Pag
60388	225	60471	246	60731	102	61071	141	61357	230
60389	225	60472	246	60740	102	61072	141	61358	230
60390	119	60473	246	60746	102	61073	141	61359	119
60391	119	60474	246	60760	102	61074	141	61360	231
60392	225	60475	246	60761	102	61075	141	61401	325
60393	225	60476	246	60776	102	61076	141	61403	124
60397	227	60477	246	60791	102	61077	141	61404	124
60398	222	60478	246	60803	83	61082	140	61405	124
60399	222	60479	246	60803	135	61084	141	61407	325
60401	120	60480	246	60804	83	61085	141	61408	122
60402	115	60481	246	60804	135	61086	141	61409	174
60403	120	60485	245	60805	83	61087	141	61410	92
60404	107	60487	244	60805	135	61088	141	61411	92
60405	246	60488	245	60812	174	61089	141	61412	92
60406	246	60489	245	60814	174	61090	305	61413	92
60407	246	60491	244	60818	174	61091	305	61414	82
60408	92	60492	244	60823	174	61092	305	61415	174
60409	93	60494	244	60825	174	61093	305	61416	122
60410	92	60495	244	60829	174	61094	305	61418	122
60411	93	60497	119	60922	174	61095	175	61419	313
60412	92	60498	119	60924	174	61096	175	61420	124
60413	93	60501	246	60928	174	61097	175	61421	107
60414	92	60502	246	61001	176	61098	175	61424	174
60415	93	60503	246	61001	304	61101	237	61425	124
60416	92	60504	246	61002	176	61102	237	61430	174
60417	93	60505	246	61002	304	61103	237	61460	107
60419	93	60506	246	61004	176	61107	172	61461	106
60420	106	60507	92	61005	175	61109	172	61481	107
60421	106	60508	92	61007	173	61110	142	61524	108
60422	105	60509	92	61008	175	61112	172	61524	311
60423	93	60510	234	61009	172	61113	142	61529	108
60424	106	60511	235	61010	140	61114	142	61529	311
60425	105	60512	120	61012	175	61116	142	61530	80
60426	105	60513	235	61013	142	61121	142	61534	108
60427	93	60514	120	61015	140	61122	142	61534	311
60428	106	60516	120	61016	140	61133	122	61535	80
60429	107	60517	120	61017	142	61134	122	61539	108
60429	229	60518	120	61019	140	61135	122	61539	311
60430	105	60519	234	61020	142	61136	122	61540	80
60431	117	60520	93	61021	140	61308	92	61545	80
60432	117	60521	247	61023	175	61310	92	61550	80
60433	117	60522	247	61024	85	61312	92	61608	110
60434	105	60524	226	61025	175	61316	93	61609	110
60435	106	60526	236	61029	140	61318	93	61610	165
60436	106	60527	226	61030	85	61319	194	61615	108
60437	106	60528	226	61031	140	61320	93	61615	311
60438	106	60529	226	61033	84	61321	194	61620	108
60441	232	60545	224	61034	84	61323	93	61620	311
60444	224	60546	224	61036	85	61326	93	61621	108
60447	232	60547	224	61041	140	61330	93	61621	311
60448	82	60569	246	61043	140	61335	93	61622	108
60455	246	60570	246	61044	140	61341	231	61622	311
60456	246	60571	246	61051	140	61342	231	61623	108
60457	246	60572	246	61052	173	61343	231	61623	311
60458	246	60573	246	61053	173	61344	231	61624	108
60459	245	60574	246	61055	173	61346	231	61624	311
60461	106	60577	246	61056	173	61347	231	61625	108
60462	106	60610	109	61062	173	61348	231	61625	311
60463	106	60610	311	61063	173	61349	231	61626	108
60464	106	60612	109	61064	140	61351	228	61626	311
60465	106	60612	311	61065	173	61352	229	61629	108
60467	106	60700	102	61066	173	61353	225	61629	311
60468	106	60701	304	61067	173	61354	231	61630	108
60469	106	60702	304	61069	172	61355	225	61630	311
60470	246	60710	102	61070	141	61356	231	61631	108

Ref	Pag	Ref	Pag	Ref	Pag	Ref	Pag	Ref	Pag
61631	311	61820	138	62153	186	62367	194	62481	191
61634	108	61821	160	62160	185	62368	194	62482	191
61634	311	61823	160	62180	186	62369	197	62483	190
61635	108	61825	138	62202	186	62371	195	62484	190
61635	311	61828	138	62204	186	62373	195	62485	191
61636	108	61830	138	62210	185	62374	179	62486	191
61636	311	61831	138	62211	186	62380	175	62487	132
61639	108	61832	138	62215	185	62381	163	62489	132
61639	311	61835	138	62216	185	62382	163	62491	190
61640	108	61836	138	62220	185	62384	163	62492	190
61640	311	61838	138	62225	185	62388	197	62495	132
61641	108	61840	138	62235	185	62391	196	62496	190
61641	311	61841	138	62252	165	62392	196	62498	133
61644	108	61843	138	62260	185	62393	196	62500	101
61644	311	61845	138	62261	196	62394	174	62500	133
61645	108	61848	138	62262	196	62395	174	62503	97
61645	311	61850	138	62263	196	62399	180	62504	97
61646	108	61860	138	62271	195	62406	175	62505	97
61646	311	61871	138	62272	195	62409	167	62506	97
61649	108	61880	138	62273	195	62410	190	62507	97
61649	311	61881	138	62278	198	62415	190	62512	115
61650	108	61901	164	62279	198	62424	174	62513	115
61650	311	61903	166	62300	193	62430	190	62515	115
61651	108	61904	166	62302	198	62435	102	62516	115
61651	311	61905	166	62303I	197	62436	195	62519	131
61655	108	61906	166	62304I	197	62439	195	62519	308
61655	311	61907	166	62306	180	62440	191	62521	115
61660	108	61908	164	62306	197	62441	191	62524	115
61660	311	61909	166	62307	179	62442	191	62525	164
61671	364	61911	164	62308I	197	62443	191	62528	101
R61671A	364	61912	121	62315	194	62444	191	62528	133
R61671B	364	61913	166	62317	180	62445	102	62530	80
R61671D	364	61918	165	62317	326	62446	102	62530A	80
R61671F	364	61919	166	62318	179	62447	191	62531	115
61672	365	61920	165	62320	194	62448	191	62532	134
61673	365	61921	164	62321	194	62450	132	62533	134
61674	365	61925	121	62322	194	62452	132	62535	80
61675	365	61925A	121	62325	193	62453	132	62535A	80
61676	365	61925R	121	62326	198	62454	132	62540	80
61681	364	61932	198	62329	198	62456	133	62540A	80
61690	369	61935	198	62330	198	62457	133	62545A	80
61700	128	61939	198	62334	180	62458	133	62551	164
61700	378	61940	121	62336	195	62459	132	62555	164
61702	129	61940A	121	62337	180	62460	190	62576	191
61703	130	61940R	121	62337	197	62461	162	62577	191
61705	129	61970	121	62338	193	62462	162	62578	191
61706	130	61970A	121	62341	198	62463	162	62601	96
61707	130	61970R	121	62342	193	62464	162	62602	96
61708	131	61974	121	62344	247	62465	162	62603	96
61709	131	61974	325	62346	195	62466	162	62604	96
61710	129	61977	121	62347	195	62468	164	62605	96
61714	129	61977	325	62352	198	62469	162	62606	96
61715	129	62001	185	62353	179	62470	162	62607	96
61716	128	62003	185	62354	194	62471	167	62608	96
61716	378	62010	185	62355	193	62472	190	62609	96
61718	129	62023	185	62356	193	62472	269	62610	115
61721	131	62035	185	62358	176	62473	190	62611	115
61722	131	62051	186	62358	303	62473	269	62612	115
61725	130	62054	186	62359	247	62475	190	62613	115
61730	128	62056	186	62361	195	62475	269	62614	115
61730	378	62060	185	62362	195	62476	191	62615	115
61735	130	62110	185	62363	197	62477	191	62616	115
61740	131	62115	185	62364	194	62478	193	62617	115
61741	131	62120	185	62365	194	62479	193	62618	115
61746	131	62135	185	62366	194	62480	191	62619	115



Ref	Pag	Ref	Pag	Ref	Pag	Ref	Pag	Ref	Pag
62620	115	62814	168	62976	183	63165	149	63376	151
62621	115	62816	168	62977	180	63166	149	63377	152
62623	115	62818	168	62977	197	63167	149	63378	152
62624	114	62820	138	62978	179	63168	149	63379	152
62630	96	62821	182	62979	118	63169	149	63380	152
62631	95	62823	168	62980	118	63170	149	63461	153
62631	96	62824	168	62981	179	63171	149	63462	153
62673	223	62825	138	62982	179	63172	149	63463	153
62675	223	62830	138	62983	180	63173	149	63471	161
62676	223	62835	138	62984	180	63174	149	63472	161
62677	105	62840	138	62985	180	63175	149	63473	161
62680	115	62841	138	62986	179	63176	149	63474	161
62683	223	62845	138	62987	113	63177	149	63480	161
62684	183	62850	138	62988	92	63178	149	63481	161
62684	223	62862	163	62989	83	63215	168	63482	161
62685	223	62864	163	62989	183	63220	168	63490	161
62686	223	62866	163	62989	274	63225	168	63494	161
62687	223	62867	163	62998	83	63261	150	63514	93
62688	223	62892	117	62998	183	63262	150	63516	93
62689	223	62901	108	62998	274	63263	150	63518	93
62689	243	62901	311	62999	83	63264	150	63520	93
62690	115	62902	117	62999	183	63265	150	63524	93
62702	196	62903	167	63005	243	63266	150	63528	93
62715	196	62904	167	63008	160	63267	150	63531	144
62716	196	62905	167	63010	199	63268	151	63532	144
62720	196	62906	167	63012	199	63269	151	63533	144
62721	196	62907	167	63013	200	63270	152	63534	144
62725	196	62908	183	63015	243	63271	150	63535	144
62726	196	62912	123	63016	183	63272	151	63536	144
62750	111	62913	177	63017	183	63273	151	63541	144
62750	308	62916	177	63018	200	63274	151	63542	144
62751	147	62924	181	63019	200	63275	151	63543	144
62753	147	62926	181	63020	200	63276	151	63544	144
62754	147	62928	183	63021	200	63277	152	63545	144
62755	147	62929	181	63022	200	63278	152	63546	144
62756	147	62930	181	63026	199	63279	152	63550	145
62757	147	62931	182	63028	200	63280	152	63551	145
62758	147	62933	182	63031	199	63302	176	63552	145
62759	147	62938	183	63033	201	63302	303	63553	145
62761	147	62939	181	R63033	201	63303	303	63554	145
62762	147	62940	181	63036	160	63304	175	63555	145
62764	147	62941	177	63037	200	63305	303	63556	145
62766	147	62942	119	63038	223	63310	190	63557	145
62768	147	62943	119	63038	243	63312	303	63558	145
62769	147	62945	123	63053	201	63315	190	63559	146
62770	147	62946	123	R63053A	201	63319	303	63561	145
62771	147	62947	181	63054	199	63320	190	63562	145
62772	147	62948	160	63060	181	63331	305	63567	145
62773	147	62949	160	63061	181	63332	305	63568	145
62780	148	62951	174	63062	181	63360	190	63570	146
62781	148	62952	123	63063	181	63361	150	63571	146
62782	148	62954	182	63064	181	63362	150	63572	146
62783	148	62955	182	63065	181	63363	150	63573	145
62784	148	62956	182	63070	181	63364	150	63574	145
62785	148	62957	93	63071	181	63365	150	63575	145
62786	148	62958	112	63072	181	63366	150	63576	146
62787	148	62959	93	63073	181	63367	150	63577	145
62789	148	62962	102	63074	181	63368	151	63578	145
62790	148	62963	102	63075	181	63369	151	63579	146
62791	147	62964	282	63115	89	63370	152	63580	146
62792	147	62970	174	63130	89	63371	150	63581	146
62793	147	62971	174	63161	149	63372	151	63582	146
62797	148	62972	93	63162	149	63373	151	63585	146
62811	96	62973	182	63163	149	63374	151	63586	144
62812	96	62974	183	63164	149	63375	151	63586	326

Ref	Pag	Ref	Pag	Ref	Pag	Ref	Pag	Ref	Pag
63588	146	63741	89	64445	314	66065Z	272	66242	273
63589	146	63751	89	64446	104	66067	272	66249	282
63598	146	63761	89	64446	314	66099	281	66255Z	273
63599	146	63771	89	64450	104	66102	272	66265	273
63600	148	63828	70	64450	314	66102Z	272	66265E	154
63601	148	63829	70	64451	104	66104	272	66265E	277
63602	148	63871	161	64451	314	66110	272	66265H	276
63603	148	63872	161	64457	121	66110E	154	66265J	154
63604	148	63873	161	64457	325	66110E	277	66265J	277
63605	148	63874	161	64458	121	66110H	276	66265P	275
63606	147	63880	161	64458	325	66110J	154	66265R	279
63607	147	63881	161	64460	104	66110J	277	66265Z	273
63608	148	63882	161	64460	314	66110P	275	66267	273
63609	144	63890	161	64461	104	66110Z	272	66299	281
63610	147	63894	161	64461	314	66112	272	66302	273
63611	147	63911	231	64472	327	66115	272	66302Z	273
63612	147	63912	123	64473	327	66115H	276	66310	273
63613	70	63913	123	64474	327	66115P	275	66310E	154
63614	70	63914	123	64475	327	66115Z	272	66310E	277
63617	147	63915	123	64476	327	66116	283	66310H	276
63618	148	64040	93	64477	327	66117	272	66310J	154
63619	144	64060	93	64501	305	66118	283	66310J	277
63620	69	64407	176	65003	185	66120	272	66310P	275
63621	89	64407	303	65004	185	66120H	276	66310Z	273
63623	89	64408	176	65012	185	66120P	275	66315	273
63624	69	64408	303	65025	185	66120Z	272	66315H	276
63625	89	64409	176	65031	138	66122	272	66315P	275
63626	69	64409	303	65035	185	66140	272	66315Z	273
63627	89	64418	109	65037	138	66140Z	272	66320	273
63628	69	64418	314	65041	138	66142	272	66320H	276
63629	89	64422	109	65044	109	66155	272	66320P	275
63631	89	64422	314	65044	315	66155Z	272	66320Z	273
63632	69	64424	105	65046	138	66165	272	66340	273
63633	89	64424	315	65050	109	66165E	154	66340Z	273
63635	89	64425	109	65050	315	66165E	277	66349	282
63636	69	64425	315	65060	185	66165H	276	66350	282
63637	89	64426	105	65110	185	66165J	154	66351	282
63638	148	64426	315	65118	185	66165J	277	66352	282
63639	89	64427	105	65135	185	66165P	275	66353	282
63640	69	64427	315	65160	185	66165R	279	66355	273
63641	89	64428	105	65210	185	66165Z	272	66355Z	273
63643	89	64428	315	65215	185	66167	272	66365	273
63647	89	64429	105	65218	185	66202	273	66365E	154
63648	148	64429	315	65235	185	66202Z	273	66365E	277
63651	89	64430	109	65260	185	66210	273	66365H	276
63656	89	64430	315	65925	337	66210E	154	66365J	154
63661	89	64431	109	65930	337	66210E	277	66365J	277
63666	89	64431	315	65935	337	66210H	276	66365P	275
63671	89	64432	182	66002	272	66210J	154	66365R	279
63681	89	64433	182	66002Z	272	66210J	277	66365Z	273
63691	89	64434	182	66010	272	66210P	275	66402	273
63700	89	64435	109	66010Z	272	66210Z	273	66402Z	273
63712	70	64435	315	66012	272	66212	273	66410	273
63714	70	64436	182	66015	272	66215	273	66410E	154
63720	69	64437	182	66015Z	272	66215H	276	66410E	277
63724	69	64438	109	66017	272	66215P	275	66410H	276
63725	71	64438	314	66020	272	66215Z	273	66410J	154
63726	69	64439	182	66020Z	272	66217	273	66410J	277
63727	71	64440	109	66022	272	66220	273	66410P	275
63728	69	64440	315	66036R	279	66220H	276	66410Z	273
63729	70	64441	109	66037R	279	66220P	275	66415	273
63731	89	64441	315	66040	272	66220Z	273	66415H	276
63732	69	64444	104	66040Z	272	66222	273	66415P	275
63736	69	64444	314	66042	272	66240	273	66415Z	273
63740	69	64445	104	66065	272	66240Z	273	66420	273

Ref	Pag	Ref	Pag	Ref	Pag	Ref	Pag	Ref	Pag
66420Z	273	66742	333	66824	331	66912H	276	R67002	317
66465	273	66745	335	66825	332	66912P	275	R67003	125
66465E	154	66746	82	66826	332	66913H	276	R67003	317
66465E	277	66746	335	66827	332	66913P	275	67004	107
66465H	276	66746	372	66828	332	66914H	276	67004	229
66465J	154	66749	82	66830	332	66914P	275	R67004	125
66465J	277	66749	335	66844	332	66916H	276	R67004	317
66465P	275	66750	160	66870	343	66916P	275	67005	104
66465R	279	66751	160	66871	343	66920	274	67005	313
66465Z	273	66752	160	66872	343	66921	274	R67005	125
66502	272	66753	82	66873	343	66923	273	R67005	317
66502Z	272	66753	335	66874	343	66923Z	273	67006	104
66510	272	66755	158	66875	343	66925	273	67006	313
66510Z	272	66756	158	66876	344	66925Z	273	R67006	125
66515	272	66757	158	66877	344	66926	326	R67006	317
66515Z	272	66758	158	66878	344	66930	284	67007	308
66520	272	66759	82	66879	344	66931	285	67008	229
66520Z	272	66759	335	66901	274	66932	285	67009	230
66540	272	66760	329	66901D	274	66933	284	67010	111
66540Z	272	66761	329	66901DH	276	66933C	284	67010	308
66550	283	66762	329	66901DZ	274	66934	284	67011	310
66555	282	66763	329	66901F	274	66934C	284	67012	197
66565	272	66764	329	66901P	275	66935	285	67012	309
66565E	155	66765	329	66902	274	66936	284	67013	197
66565E	278	66765E	155	66902D	274	66936C	284	67013	309
66565J	155	66765E	278	66902DH	276	66936T	284	67014	197
66565J	278	66765J	155	66902DZ	274	66937	284	67014	309
66565R	279	66765J	278	66902F	274	66937C	284	67015	310
66565Z	272	66766	329	66902P	275	66938	284	67016	197
66599	281	66767	329	66903	274	66938	284	67016	309
66610	273	66768	329	66903D	274	66939	284	67017	197
66610E	155	66769	329	66903DH	276	66940	284	67017	309
66610E	278	66772	158	66903DZ	274	66942	284	67018	197
66610H	276	66773	158	66903F	274	66945	285	67018	309
66610J	155	66775	334	66903P	275	66945S	285	67019	197
66610J	278	66776	334	66904	274	66945T	285	67019	309
66610P	275	66777	334	66904D	274	66947	285	67020	197
66610Z	273	66780	158	66904DH	276	66948	284	67020	309
66615	273	66781	158	66904DZ	274	66948S	284	67021	197
66615H	276	66782	158	66904F	274	66949	284	67021	309
66615P	275	66783	158	66904P	275	66949S	284	67022	197
66615Z	273	66784	159	66905	274	66949T	284	67022	309
66620	273	66785	159	66905D	274	66950	285	67023	197
66620Z	273	66787	159	66905DZ	274	66951	285	67023	309
66642	283	66788	159	66905F	274	66952	285	67025	310
66665	273	66790	159	66906D	274	66953	285	67026	317
66665E	155	66791	159	66906DH	276	66956	285	67027	107
66665E	278	66792	159	66906DZ	274	66965	273	67027	229
66665H	276	66793	159	66906F	274	66965H	276	67028	107
66665J	155	66800	331	66906P	275	66965Z	273	67028	229
66665J	278	66801	331	66907	274	66972	285	67029	104
66665P	275	66802	331	66909	273	66972C	285	67029	313
66665Z	273	66804	331	66909D	274	66974	285	67030	326
66731	82	66805	331	66909DH	276	66974C	285	67031	230
66731	335	66807	330	66909DZ	274	66975	285	67032	230
66732	82	66808	332	66909P	275	66977	285	67033	230
66732	335	66812	330	66910	273	67000	125	67038	327
66733	333	66813	330	66910H	276	67000	317	67039	327
66734	333	66816	330	66910P	275	R67000	125	67043	327
66735	333	66817	330	66910Z	273	R67000	317	67044	327
66736	333	66819	330	66911	273	67001	308	67045	327
66737	333	66820	331	66911H	276	R67001	125	67046	327
66738	333	66821	331	66911P	275	R67001	317	67047	327
66739	333	66822	331	66911Z	273	67002	326	67048	327
66741	333	66823	331	66912	273	R67002	125	67049	327

Ref	Pag	Ref	Pag	Ref	Pag	Ref	Pag	Ref	Pag
67050	327	67909	274	68153	312	68500	126	68620	346
67052	327	68000	341	68154	312	68500	320	68622	346
67053	327	68001	337	68161	312	68501	126	68624	346
67055	327	68002	337	68173	100	68501	320	68626	346
67056	327	68003	337	68174	100	68502	126	68627	187
67058	327	68004	337	68175	100	68502	320	68628	346
67059	327	68005	110	68176	100	68504	126	68629	187
67062	327	68006	110	68177	100	68504	320	68639	187
67063	327	68007	177	68178	100	68505	126	68640	81
67065	327	68008	180	68179	100	68505	320	68640	336
67066	327	68008	326	68183	101	68506	346	68641	81
67069	327	68009	179	68184	101	68508	346	68641	336
67070	327	68010	341	68193	101	68509	346	68643	187
67074	327	68017	177	68194	101	68510	346	68644	187
67084	327	68021	179	68200	346	68511	326	68650	319
67090	327	68023	310	68203	346	68512	346	68651	319
67105	335	68024	310	68205	187	68513	326	68651	405
67131	111	68026	310	68213	312	68514	346	68652	319
67131	308	68030	337	68215	187	68515	316	68652	405
67136	111	68031	337	68225	187	68516	346	68660	81
67136	308	68040	337	68235	187	68518	346	68660	336
67137	111	68041	337	68240	347	68520	346	68661	188
67137	308	68043	337	68246	316	68522	346	68662	188
67140	312	68048	337	68248	337	68524	346	68663	188
67141	312	68049	337	68250	310	68526	346	68664	188
67142	312	68050	310	68252	310	68536	345	68666	188
67148	312	68052	310	68253	310	68537	345	68667	188
67149	312	68053	310	68254	310	68538	345	68668	188
67153	327	68054	310	68285	110	68540	345	68714	341
67156	312	68056	310	68286	110	68544	345	68716	341
67158	327	68057	310	68305	228	68546	345	68718	341
67163	327	68058	310	68306	228	68547	345	68723	339
67182	230	68060	337	68307	228	68548	345	68724	339
67183	230	68061	337	68308	346	68550	345	68725	341
67410	93	68064	316	68310	346	68554	345	68726	337
67412	93	68065	316	68340	310	68556	345	68729	339
67414	104	68069	316	68341	310	68557	345	68730	341
67414	313	68070	316	68342	310	68560	345	68731	337
67415	93	68080	110	68350	310	68566	345	68732	339
67417	93	68082	110	68351	310	68567	345	68735	341
67420	93	68085	115	68354	310	68570	345	68736	337
67421	104	68085	200	68357	310	68580	345	68740	81
67421	314	68086	316	68402	126	68581	345	68740	336
67427	104	68087	316	68402	320	68587	345	68741	81
67427	314	68090	313	68403	126	68588	345	68741	336
67433	104	68091	316	68403	320	68590	345	68750	340
67433	314	68092	316	68404	126	68591	345	68751	340
67434	104	68101	117	68404	320	68597	345	68752	340
67434	314	68102	117	68405	126	68598	345	68753	340
67435	104	68107	346	68405	320	68601	196	68754	340
67435	314	68120	346	68406	346	68602	196	68808	339
67604	272	68121	346	68407	346	68603	196	68810	338
67610	272	68131	313	68408	346	68604	126	68814	338
67615	272	68132	313	68410	346	68604	320	68818	338
67665	272	68133	313	68411	347	68605	126	68821	338
67824	338	68134	313	68412	346	68605	320	68822	338
67828	338	68135	313	68414	346	68607	346	68823	338
67832	338	68136	313	68416	346	68608	346	68824	338
67836	338	68137	313	68418	346	68609	346	68825	338
67901	274	68141	312	68420	346	68610	346	68827	338
67902	274	68142	312	68422	346	68612	346	68828	338
67903	274	68147	312	68424	346	68614	346	68829	338
67904	274	68148	312	68441	347	68616	346	68831	338
67905	274	68150	312	68460	347	68618	346	68832	338
67906	274	68151	312	68480	347	68619	187	68833	338



Ref	Pag	Ref	Pag	Ref	Pag	Ref	Pag	Ref	Pag
68835	338	68992	322	69061	390	69131	257	69219	426
68836	338	68993	322	69062	403	69132	260	69222	387
68842	338	68994	323	69063	367	69132	380	69223	372
68862	339	68995	321	69064	403	69133	385	69225	299
68863	339	68996	322	69065	265	69134	375	69226	299
68882	338	68997	322	69065	401	69135	374	69227	384
68890	347	68998	322	69066	265	69136	139	69234	300
68891	323	68999	322	69066	401	69138	262	69235	299
68892	323	69001	258	69068	367	69138	379	69236	299
68893	323	69002	258	69070	430	69139	255	69237	299
68900	321	69002	389	69071	428	69140	139	69240	299
68901	321	69004	258	69072	428	69141	243	69241	300
68904	321	69006	59	69075	430	69141	434	69245	354
68906	321	69006	259	69078	428	69145	262	69246	354
68908	321	69012	258	69079	371	69145	389	69248	300
68910	321	69012	389	69081	414	69146	139	69249	300
68912	321	69015	258	69083	356	69151	418	69250	299
68914	321	69018	259	69084	355	69152	139	69251	299
68915	321	R69018	259	69085	357	69156	139	69259	421
68916	321	R69018	259	69087	254	69162	265	69260	267
68918	321	R69018	259	69088	255	69162	402	69260	403
68924	321	69019	257	69089	253	69163	405	69261	243
68926	321	69020	259	69091	253	69164	265	69261	434
68928	321	69022	267	69092	254	69164	402	69263	263
68930	324	69023	267	69093	255	69165	139	69263	390
68932	321	69024	175	69094	255	69166	383	69264	263
68934	321	69027	259	R69094A	255	69167	383	69264	390
68935	324	R69027	259	69095	254	69168	139	69266	263
68936	341	69028	259	69096	257	69169	374	69266	390
68938	321	69029	175	69097	256	69170	374	69267	263
68939	324	69030	267	69097	257	69171	429	69267	264
68940	324	69032	261	69098	256	69172	265	69267	390
68942	321	69032	380	69099	253	69172	401	69267	391
68944	321	69033	261	R69099B	253	69173	265	69270	396
68945	324	69033	381	R69099B	254	69173	401	69272	396
68946	321	69034	258	R69099C	253	69174	383	69273	396
68948	321	69036	391	R69099C	254	69175	429	69274	396
68950	324	69037	264	R69099C	255	69178	429	69275	396
68952	321	69037	391	R69099C	256	69179	382	69276	395
68954	324	69038	264	R69099C	257	69183	355	69277	394
68955	324	69038	391	69100	256	69184	429	69278	397
68960	324	69039	264	R69100A	256	69185	429	69279	397
68964	324	69039	391	R69100B	256	69186	429	69281	396
68965	324	69041	108	R69100B	257	69187	429	69282	396
68969	318	69041	186	69101	257	69192	424	69283	406
68970	324	69041	311	69107	59	69193	427	69285	407
68971	324	69042	421	69107	259	69194	414	69286	406
68972	324	69045	262	69108	59	69195	412	69287	407
68973	324	69045	389	69108	259	R69195N	413	69288	415
68974	319	69046	421	69109	59	69196	386	69291	394
68976	177	69047	421	69109	259	69197	382	69292	395
68977	177	69048	421	69110	258	69199	375	69294	265
68978	177	69050	418	69111	357	69200	384	69294	402
68979	177	69051	421	69115	369	69202	300	69295	412
68980	321	69052	421	69116	417	69203	300	R69295A	413
68981	318	69053	421	69118	368	69204	300	R69295B	413
68982	318	69054	421	69120	407	69205	300	69296	265
68983	318	69055	421	69121	373	69207	300	69296	402
68984	319	69056	421	69122	387	69208	300	69297	394
68985	321	69057	421	69123	373	69211	301	69300	432
68987	177	69058	421	69125	368	69212	301	69301	432
68988	318	69059	421	69130	368	69213	300	69302	425
68989	325	69060	266	69131	253	69214	299	69303	425
68990	321	69060	404	69131	254	69215	300	69308	376
68991	323	69061	263	69131	256	69217	299	69310	431

Ref	Pag	Ref	Pag	Ref	Pag	Ref	Pag	Ref	Pag
69311	377	69420	439	69791	362	72128	33	79624	35
69314	431	69421	439	69792	362	72129	33	79628	35
69315	353	69423	439	69793	362	72132	33	79714	35
69316	353	69424	439	69794	362	72214	32	79830	35
69317	325	69430	418	69795	362	72216	32	79916	35
69317	388	69453	421	69815	360	72218	32	79920	35
69318	264	69454	421	69816	360	72220	32	79924	35
69318	388	69455	421	69820	363	72318	33	79928	35
69319	264	69458	421	69824	363	72324	33	85000	46
69319	388	69459	421	69825	363	72420	33	85003	46
69320	430	69460	421	69830	363	72423	33	85016	47
69322	393	69461	421	69840	363	72424	33	85018	47
69323	393	69462	421	69850	363	72428	33	85020	47
69324	393	69463	421	71318	76	72620	33	85022	47
69325	392	69464	421	71320	76	72624	33	85024	47
69326	392	69471	268	71322	76	72625	33	85026	47
69330	393	69471	399	71324	76	72628	33	85028	47
69332	261	69473	269	71326	76	72629	33	85032	47
69332	380	69473	400	71328	76	72632	33	85116	47
69333	261	69474	269	71710	58	72714	33	85118	47
69333	381	69474	400	R71710	58	72716	33	85120	47
69335	352	69476	268	R71711	58	72720	33	85122	47
69337	260	69476	399	71723	58	72801	95	85124	47
69337	380	69493	427	R71723	58	72802	95	85125	47
69342	392	69501	305	71726	76	72803	95	85126	47
69349	387	69523	372	71780	59	72804	95	85128	47
69350	419	69561E	350	71815	62	72805	95	85129	47
69351	419	69561F	350	71818	76	72806	95	85132	47
69352	417	69561I	350	71820	76	72807	95	85212	47
69355	420	R69561A	351	71821	62	72808	95	85214	47
69360	266	R69561B	351	71822	76	72809	95	85216	47
69360	404	R69561D	351	71824	76	72810	95	85218	47
69361	263	R69561E	351	71826	76	72811	95	85220	47
69361	390	R69561F	351	71828	76	72831	95	85420	47
69363	405	R69561N	351	71862	64	72850	94	85424	47
69365	263	R69561P	351	71864	64	72851	94	85624	47
69365	390	R69561Q	351	71866	64	72853	94	85625	47
69368	366	R69561S	351	71868	64	72854	94	85629	47
69369	367	R69561T	351	71871	64	72855	94	85712	47
69370	370	R69561V	351	71872	64	72856	94	85714	47
69372	408	R69561V	351	71874	64	72857	94	85716	47
69373	408	R69561W	351	71875	64	72858	94	85718	47
69380	414	R69561C	351	71876	64	72859	94	85916	47
69381	410	R69561Z	351	71878	64	72916	33	85918	47
69382	410	69722	360	71914	78	72918	33	85920	47
R69382F	411	69723	360	71916	78	72920	33	85922	47
69383	358	69735	363	71918	78	72924	33	85924	47
69384	358	69736	363	71920	78	72928	33	85926	47
69385	371	69750	363	71922	78	72932	33	85928	47
69388	356	69751	363	71924	78	79000	34	85932	47
69396	398	69761	361	71926	78	79003	34	88000	44
69400	440	69762	361	71928	78	79016	35	88016	44
69400F	440	69763	361	71931	78	79020	35	88018	44
69400P	440	69764	361	71932	78	79024	35	88020	44
R69400A	441	69765	361	71933	78	79028	35	88022	44
R69400B	441	69771	361	72000	32	79116	35	88024	44
R69400N	441	69772	361	72016	32	79120	35	88026	44
R69400R	441	69773	361	72020	32	79124	35	88028	44
69401	440	69774	361	72024	32	79128	35	88032	44
69401F	440	69775	361	72028	32	79214	35	88116	45
69401P	440	69781	362	72032	32	79216	35	88118	45
69410	439	69782	362	72116	33	79218	35	88120	45
69411	439	69783	362	72120	33	79220	35	88121	45
69412	438	69784	362	72124	33	79420	35	88122	45
69413	438	69785	362	72125	33	79424	35	88124	45

Ref	Pag	Ref	Pag	Ref	Pag
88125	45	90626	39	99915	442
88126	45	90628	39	99916	442
88128	45	90632	39	99917	442
88129	45	90712	39	99918	442
88132	45	90714	39	99919	442
88212	44	90716	39	99920	442
88214	44	90718	39	99921	442
88216	44	90912	39	99922	442
88218	44	90914	39		
88220	44	90916	39		
88318	45	90918	39		
88324	45	90920	39		
88420	45	90922	39		
88424	45	90924	39		
88620	45	90926	39		
88622	45	90928	39		
88624	45	90932	39		
88626	45	94000	42		
88628	45	94003	42		
88632	45	94016	43		
88712	45	94020	43		
88714	45	94024	43		
88716	45	94028	43		
88718	45	94116	43		
88912	45	94120	43		
88914	45	94124	43		
88916	45	94125	43		
88918	45	94128	43		
88920	45	94129	43		
88922	45	94214	43		
88924	45	94216	43		
88926	45	94218	43		
88928	45	94220	43		
88932	45	94318	43		
90000	38	94324	43		
90016	38	94420	43		
90018	38	94424	43		
90020	38	94620	43		
90022	38	94624	43		
90024	38	94628	43		
90026	38	94714	43		
90028	38	94716	43		
90032	38	94916	43		
90116	39	94920	43		
90118	39	94924	43		
90120	39	94928	43		
90122	39	98803	99		
90124	39	98804	99		
90125	39	98806	99		
90126	39	98807	99		
90128	39	98808	99		
90129	39	98810	99		
90132	39	98811	99		
90212	38	98903	98		
90214	38	98904	98		
90216	38	98905	98		
90218	38	98906	98		
90220	38	98907	98		
90318	39	98908	98		
90324	39	98909	98		
90420	39	98910	98		
90424	39	98911	98		
90620	39	98912	98		
90622	39	98913	98		
90624	39	98914	98		



**Índice alfabético**



**Sommaire alphabétique**



**Alphabetisch Index**



**Alphabetical Index**



**Índice alfabético**



<b>A</b>			
ABLANDACARNE	117		
ABRE OSTRAS	183, 223		
ABRELATAS	223, 243		
ABRIDOR HUEVOS	110		
ACEITERA	164, 165		
AFILADOR CUCHILLOS	243, 434		
AIR POT	190, 269, 400		
AIRPOT	268, 269, 399, 400		
ANILLA ANTI-GOTEO	200		
ARMARIO ESTERILIZADOR	434		
ARMARIO REFRIGERADOR	428, 429		
ARO	337, 346		
ARO PERFORADO	345		
ASADOR	71		
AZUCARERO	175, 185		
<b>B</b>			
BANDEJA	285		
BAND. / FUENTE	138, 139, 140, 141, 144, 145, 146, 147, 149, 150, 151, 152, 153, 177		
BANDEJA CAMARERO	138, 139, 148		
BANDEJA HORNO	26		
BANDEJA ISOTÉRMICA	284		
BAÑO MARIA	20, 23, 325, 388, 391		
BARRA SUJECCIÓN NOTAS	102		
BÁSCULA	128, 129, 130, 131, 308, 378		
BATERÍA 5 PIEZAS	30		
BATERÍA 8 PIEZAS	32, 34, 36, 38, 40, 42, 44, 46		
BATIDOR	96, 98, 105, 108, 109, 186, 311, 315		
BATIDORA	355, 356, 357, 358, 360, 361, 362, 363, 364, 365, 410, 412, 413, 414		
BIBERÓN DECORACIÓN	121, 325		
BOBINA FILM	304		
BOBINA VACÍO	421		
BOL	112, 145, 146, 147, 148, 149, 150, 152, 174, 284, 285, 309		
BOLAS AISLANTES SOUS VIDE	426		
BOLSAS VACÍO	421		
BOMBA VACÍO	201		
BOQUILLA SERVIDORA	200		
BOQUILLAS	321, 322, 323		
BOTELLA BIBERÓN	121, 325		
BOTELLA DOSIFICADORA	198		
BOTELLA PREPARACIÓN ALIÑO	165		
BOTES VACÍO	421		
<b>C</b>			
CACEROLA	16, 19, 22, 24, 28, 31, 32, 35, 36, 38, 41, 43, 44, 47, 48, 49, 51, 52, 54, 56, 163, 170		
CACEROLA ALTA	16, 19, 22, 24		
CACEROLA BAJA	51, 52		
CACEROLA OVAL	54, 56, 169, 170		
CACEROLA VAPOR	19, 33, 35, 37, 39, 41, 43, 45, 47, 112		
CACILLO	92, 94, 95, 96, 97, 98, 99, 148		
CACILLO PERFORADO	92, 148		
CACILLO SALSA	94, 95, 96, 98, 99		
CADENA	337		
CAFETERA	185, 186, 187		
CAFETERA GOTEO	396, 397		
CALDERO	111		
CALENTADOR	263, 264, 390, 391, 438, 439, 440, 441		
CALENTADOR CHAFING	258, 389		
CALENTADOR LÍQUIDOS	259		
CAMINO DE MESA	159		
CAMPANILLA	175		
CARRÓ SERVICIO	282, 283, 285		
CASCANUECES	183		
CAZO BOMBADO	25		
CAZO CÓNICO	18, 20		
CAZO FRANCÉS	18, 20		
CAZO RECTO	17, 20, 23, 25, 29, 31, 32, 34, 35, 37, 38, 40, 41, 42, 43, 44, 46, 47, 48, 49, 51, 52, 98		
CAZO RECTO ALTO	17, 20, 23, 25		
CEDAZO	310		
CENICERO	177, 305		
CENTRIFUGADORA	124		
CEPILLO PARA TABLA CORTE	246		
CEPILLO RECOGEDOR	176, 303		
CESTA	299, 300, 301		
CESTILLO	172, 173		
CHAFING DISH	253, 254, 255, 256, 257, 258		
CHAIRA	238, 241		
CIERRE PORTAFICHAS	285		
COCEDOR AL VAPOR	373		
COCTELERA	197		
COLADOR	26, 33, 37, 39, 41, 43, 45, 93, 114, 115, 198		
COLGADOR	102		
CONTENEDOR ALIMENTOS	122		
CONTENEDOR CUBIERTOS	102		
COOKINGME	350, 351		
COPA	326		
CORDEL COCINA	82		
CORTA VEGETALES	369		
CORTADOR	222, 223, 225, 226, 227, 228, 370		
CORTADORA FIAMBRE	368		
CORTAPASTAS	316		
CORTAPIZZA	107, 229		
CREPERA	71, 72, 76, 386, 387		
CUBETA	154, 155, 272, 273, 275, 276, 277, 278		
CUBETA PERFORADA	272, 273		
CUBIERTOS	249		
CUBITERA	197		
CUBO	112		
CUBO ENFRIABOTELLAS	193, 194, 195		
CUBRE QUESO/TARTA	175		
CUBREPLATOS	175, 285		
CUCHARA APOYA UTENSILIOS	93		
CUCHARA LISA	92, 94, 95, 96, 97, 98, 99, 100, 101, 148, 149		
CUCHARA OBLICUA	92		
CUCHARA PERFORADA	92, 94, 95, 96, 98, 99, 100, 148		
CUCHARILLA COCKTAIL	198		
CUCHILLO	222, 223, 224, 238, 239, 240, 241, 242		
CUECE ESPECIAS	112		
CUECEPASTAS	33, 37		
CUSCUSERA	112		
<b>D</b>			
DELANTAL	303		
DESCÁPULADOR	200		
DESCORAZONADOR	223, 224, 227		
DESESCAMADOR DE PESCADO	183		
DESHIDRATADOR	372, 373		
DESHOJADOR DE HIERVAS	119		
DISPENSADOR	166, 267		
DISPENSADOR JABÓN	305		
DISPENSADOR REPOSTERÍA	317		
DOBLE FONDO	273, 275, 276		
DOSIFICADOR	125, 317		
DOSIFICADOR LICOR	198		
<b>E</b>			
EMBUDO	115, 200		
EMPUJADOR	347		
ENCENDEDOR	177		
ENSALADERA	174		
ESCURREFRITOS	113		
ESCURRIDERA	33, 37, 39, 41, 43, 45, 113		
ESPÁTULA	104, 105, 314, 315		
ESPÁTULA LISA	92, 95, 96, 97, 98, 100, 104, 105, 106, 107, 223, 314, 315		
ESPÁTULA PERFORADA	92, 94, 95, 98, 99, 100		
ESPÁTULA PIZZA	106		
ESPECIERO	166, 167		
ESPUMADERA	92, 93, 94, 95, 96, 97, 98, 99		
ESPUMADOR DE LECHE	398		
ESTANTE TUBULAR	283		
ESTANTERIA	288, 289, 290, 291, 292, 293, 294, 295, 296		
ESTECAS	313		
EXPRIMIDOR	123, 406, 407, 408		

<b>F</b>			
FLANERO		335, 337, 339	
FONDUE		58	
FREIDORA		374, 375, 376, 377	
FUENTE		279	
FUENTE CHOCOLATE		264, 388	
FUENTE HONDA		111, 309	
FUENTE PARA MANTEQUILLA		174	
FUNDA		411	
FUNDA CARRO		282	
FUNDA ENFRIABOTELLAS		193	
<b>G</b>			
GANCHOS		102, 236, 249	
GEL COMBUSTIBLE		59, 259	
GOFRERA		387	
GRILL		52, 72, 74	
GUANTE		84, 85, 237	
GUIA DIVIDORA		273	
<b>H</b>			
HARINERO		113	
HERVIDOR		112	
HERVIDOR AGUA		187, 394, 395	
HERVIDOR PESCADO		26	
HORNO		392	
<b>I</b>			
INDICADOR		141	
INDICADOR		305	
INDICADOR RESERVADO		175	
INSERTO REDONDO		279	
<b>J</b>			
JAMONERO		247	
JARRA DE AGUA		196, 285	
JARRA SEPARADOR GRASA		165	
JARRA TERMO		190, 191	
JUEGO DE COCINA		95, 96	
JUEGO SALERO-PIMENTERO		162, 163	
JUEGO VINAGRERAS		162, 163	
<b>L</b>			
LÁMINA		82, 335, 372	
LAMINADOR		119, 225, 228	
LÁMPARA CALENTAMIENTO		263, 264, 390, 391	
LAZOS DE COCINA		82	
LECHERA		185	
LEGUNBRERA		174	
LIBRADOR		197, 309	
LICUADORA		415	
<b>M</b>			
MACHETE		241	
MALETA CUCHILLOS		241	
MANDOLINA		232, 233, 369	
MANGA REPOSTERÍA		324	
MANO CHINO		115	
MANO MORTERO		120	
MANOPLA		55, 85	
MANTEL INDIVIDUAL		158, 159	
MÁQUINA CUBITOS HIELO		430, 431	
MÁQUINA DE HELADO		353	
MÁQUINA ENFRIACOPAS		432	
MAQUINA HIELO SECO		432	
MÁQUINA VACÍO		417, 418, 419, 420	
MARCADOR TARTA		326	
MARTILLO		117	
MATAMOSQUITOS		436	
MAZA		198	
MEDIDOR		111, 308	
MEDIDOR PASTA		119	
MICROONDAS		392, 393	
MINI GRILL		57, 171	
MINI-CUBO		172	
MOLDE BAGUETTE		335	
MOLDE EMPANADILLAS		117	
MOLDE HUEVO		110	
MOLDE PIZZA		338	
M. REPOSTERÍA		82, 329, 330, 331, 332, 333, 334, 335, 337, 338, 339, 340, 341, 347	
MOLDES BOMBÓN		343, 344	
MOLINILLO		166, 168, 371	
MORTERO		120	
<b>N</b>			
NIDOS ALAMBRE		93	
NÚMEROS MESA		175	
<b>O</b>			
OLLA		17, 20, 22, 25, 28, 31, 33, 35, 36, 39, 41, 43, 45, 47, 48	
OLLA A PRESIÓN		61, 62, 63, 64	
OLLA BAJA		17, 20	
OLLA ELÉCTRICA		352	
OLLA SUPER ALTA		33, 37, 39, 41, 43, 45, 47	
<b>P</b>			
PAELLERA		17, 21, 22, 25, 87, 88, 89	
PALA		107	
PALA ENSALADA		94	
PALA PASTEL		94, 223	
PALA PESCADO		92, 98	
PALA PIZZA		106, 107	
PALILLERO		162	
PANERA		160, 161	
PANIFICADORA		353	
PAPELERA		176, 303	
PARRILLA		81, 274, 336	
PASAPURÉS		116, 117	
PEINE CARNE		228	
PEINE DECORACIÓN		313	
PELADOR		222, 223, 224, 225	
PICADORA		118	
PICADORA CARNE		366, 367	
PICADORA HIELO		197, 431	
PIE PORTACUBOS		193	
PINCEL		105, 109, 314, 315	
PINCHO MARISCO		183	
PINCHO MARUNO		102	
PINZA		83, 148, 179, 180, 181, 182, 183, 197, 274, 326	
PINZAS		83, 183, 274	
PIPETA PARA SALSA		122	
PISTOLA GAS		318, 319	
PISTOLA REPOSTERÍA		325	
PIZARRA		200, 202, 203, 435	
PLACA CALENTAMIENTO		258, 262, 389, 396	
PLACA HORNO		81, 336	
PLACA INDUCCIÓN		253, 254, 255, 256, 257, 260, 261, 262, 379, 380, 381	
PLANCHA GRILL		73	
PLANCHA-GRILL		383, 384, 385	
PLATO		284, 285	
PLATO CAMPING		142	
PLATO DE HUEVOS		142	
PLATO LLANO		149	
PORTA MENÚ		206, 207, 208, 209, 210, 211, 212, 213, 214, 215, 216, 217, 218, 219	
PORTARROLLOS		304	
PORTATARTA		144, 326	
POSABOTELLAS		142	
POSAVASOS		142	
POTE CILINDRICO		25, 31, 33, 35, 37, 39, 41, 43, 45, 47	
PRENSA AJOS		223	
PULVERIZADOR		164	
<b>Q</b>			
QUEMADOR		319, 405	
QUESERA		174	

## R

RABANERA	142
RACIONADOR HELADO	327
RALLADOR	118, 229, 230, 231
RASERA	93
RASQUETA	104, 313
REFRIGERADOR	430
REJILLA REPOSTERÍA	326
RELOJ COCINA	83, 135
ROBOT MULTIFUNCIÓN	371
RODILLO	312
ROTULADORES PIZARRA	203, 435
RUSTIDERA	21, 26, 80, 81

## S

SACACORCHOS	199, 200
SALAMANDRA	382
SALSERA	174
SALVAMANTELES	160
SARTÉN	47, 50, 52, 66, 67, 68, 69, 70, 71, 72, 74, 75, 76, 77
SAUTEX	18, 21, 23, 33, 47, 50
SECADOR MANOS	305
SEPARADOR CLARAS	110
SERVIDOR ESPAGUETIS	95, 96, 98, 99
SERVIDOR ZUMOS	259
SERVILLETERO	176, 304
SET LAPICES PIZARRAE	141
SET REPOSTERIA	105, 315
SIERRA SUECA	316
SIFÓN	126, 320
SIFÓN AGUA	196
SOPERA	174
SOPORTE CALDERO	112
SOPORTE COPAS	196
SOPORTE CUBIERTOS	249
SOPORTE MAGNÉTICO	242
SOPORTE MENU	175
SOPORTE MESA ENFRIABOTELLAS	193
SOPORTE PAELLERA	89
SOPORTE PAELLERA GAS BUTANO	89
SOPORTE PARA HUEVO	110
SOUS VIDE	424, 425, 427
SUJETA MANTELES	175

## T

TABLA DE CORTE	244, 245, 246, 247
TACO CUCHILLO	241, 242
TAPA	18, 21, 23, 26, 29, 33, 35, 37, 39, 41, 43, 45, 47, 50, 52, 61, 78, 80
TAPA PARA CUBETA	274, 275, 276
TAPETE	82, 335
TAPÓN	200
TARTERA	29, 31, 33, 35, 37, 39, 41, 43, 45
TAZA	284
TENAZA MARISCO	182, 183
TENEDOR	92, 93, 94, 95, 96, 97, 100, 101, 239, 241
TERMO	191
TERMÓMETRO	101, 132, 133, 134
TERMOTRANS	281
TETERA	185, 188
TIJERAS	248
TOSTADORA	265, 266, 267, 401, 402, 403, 404, 405
TRIANGULO	115

## V

VASO	285
VASOS CUBERTERÍA	249

## W

WOK	35, 50, 70, 72, 77, 262, 379
-----	------------------------------

## Y

YOGURTERAS	354
------------	-----

<b>A</b>			
AFÛTEUSE DE COUTEAUX		243, 434	
AIR POT		190, 269, 400	
AIRPOT		268, 269, 399, 400	
ALLUME-GAZ		177	
ANNEAU STOP GOUTTLES À VIN		200	
APPAREIL ANTI-MOUSTIQUES		436	
ARAIGNEE		93	
ARDOISE		200, 202, 203, 435	
ARMOIRE À STÉRILISER		434	
ASSIETTE		284, 285	
ASSIETTE		149	
ATTENDRISEUR À VIANDE		117	
<b>B</b>			
BAC		154, 155, 272, 273, 275, 276, 277, 278	
BAC PERFORE		272, 273	
BAC ROND		279	
BAHUT		20, 23, 325, 388, 391	
BAIN MARIE		253, 254, 255, 256, 257, 258	
BALANCE		128, 129, 130, 131, 308, 378	
BARRE À NOTES		102	
BASSINE		111	
BASSINE PÂTISIERE		111, 309	
BATTERIE 5 PCS.		30	
BATTERIE 8 PCS.		32, 34, 36, 38, 40, 42, 44, 46	
BATTEUR		355, 356, 357, 358, 360, 361, 362, 363, 364, 365, 410, 412, 413, 414	
BEC VERSEUR		200	
BEURRIER AVEC COUVERCLE		174	
BIBERON À DECORER		121, 325	
BILLES ISOLANTES SOUS VIDE		426	
BLOC COUTEAU		241, 242	
BOBINE DE CONSERVATION		421	
BOÎTE À CONDIMENTS		122	
BOITE À FROMAGE		174	
BOÎTES DE CONSERVATION		421	
BOL		112, 145, 146, 147, 148, 149, 150, 152, 174, 284, 285, 309	
BOUCHON		200	
BOUILLORE		187, 394, 395	
BOUEILLE BIBERON		121, 325	
BOUEILLE DOSEUSE		198	
BRAISIERE		16, 19, 22, 24	
BROCHETTE		102	
BROSSE POUR PLANCHE		246	
BROYEUR À GLAÇONS		197, 431	
<b>C</b>			
CAFETIÈRE		185, 186, 187	
CAFETIÈRE FILTRE		396, 397	
CASIER		299, 300, 301	
CASSE NOIX		183	
CASSEROLE		17, 20, 23, 25, 29, 31, 32, 34, 35, 37, 38, 40, 41, 42, 43, 44, 46, 47, 48, 49, 51, 52, 93	
CASSEROLE BOMBÉE		25	
CASSEROLE FRANÇAISE		18, 20	
CASSEROLE HAUTE		17, 20, 23, 25	
CENDRIER		177, 305	
CERCLE		337, 346	
CERCLE PERFOREE		345	
CHAÎRE		337	
CHARIOT DE SERVICE		282, 283, 285	
CHAUFFE-CAFÉ		259	
CHAUFFE-CHAFING		258, 389	
CHAUFFE-SOUBE		263, 264, 390, 391, 438, 439, 440, 441	
CHEMIN DE TABLE		159	
CISEAUX		248	
CLOCHES		175, 285	
COCOTTE À PRESSION		61, 62, 63, 64	
COCOTTE ÉLECTRIQUE		352	
COOKINGME		350, 351	
COUPE		326	
COUPE CAPSULE		200	
COUPE PATE		104, 313	
COUPELLE		284	
COUPER		222, 223, 225, 226, 227, 228, 370	
COUPERET		241	
COUSCOUSSIER		112	
COUTEAU		222, 223, 224, 238, 239, 240, 241, 242	
COUTEAU À HÛÎTRES		183, 223	
COUVERCLE		18, 21, 23, 26, 29, 33, 35, 37, 39, 41, 43, 45, 47, 50, 52, 61, 78, 80	
COUVERCLE P/BAC		274, 275, 276	
COUVERT		249	
COUVRE FROMAGE/GÂTEAU		175	
CREMIERE		185	
CREPIÈRE		71, 72, 76, 386, 387	
CROCHETS		102, 236, 249	
CUILLÈRE À GLACE		327	
CUILLÈRE À SPAGUETIS		95, 96, 98, 99	
CUILLÈRE COCKTAIL		198	
CUILLÈRE OBLIQUE		92	
CUILLÈRE RAMASSE USTENSILES		93	
CUILLÈRE LISSE		92, 94, 95, 96, 97, 98, 99, 100, 101, 148, 149	
CUILLÈRE PERFOREE		92, 94, 95, 96, 98, 99, 100, 148	
CUISEUR VAPEUR		373	
CUIT-PÂTE		33, 37	
CURETTES À HOMARD		183	
<b>D</b>			
DECOUPOIRS DIVERS		316	
DEROULEUR		304	
DESHYDRATEUR		372, 373	
DESSOUS DE PLATS		160	
DIFFUSEUR ÉPICES		112	
DISTRIBUTEUR		166, 267	
DISTRIBUTEUR		259	
DISTRIBUTEUR À SAVON		305	
DISTRIBUTEUR DE PÂTISSERIE		317	
DISTRIBUTEUR DE SERVIETTES		176, 304	
DOUBLE FOND		273, 275, 276	
DOUILLES		321, 322, 323	
<b>E</b>			
ECUMOIRE		92, 93, 94, 95, 96, 97, 98, 99	
EFFEUILLEUSE À HERBES		119	
ENSEMBLE CRAYONS POUR ARDOISE		141	
ENTONNOIR		115, 200	
ENTONNOIR À DECOR		125, 317	
ÉPLUCHE		222, 223, 224, 225	
ÉPLUCHEUSE		119, 225, 228	
ESSOREUSE		124	
ÉTAGÈRE TUBULAIRE		283	
EXPOSANT PÂTISSERIE		105, 315	
<b>F</b>			
FAITOUT		16, 19, 22, 24, 28, 31, 32, 35, 36, 38, 41, 43, 44, 47, 48, 49, 51, 52, 54, 56, 169, 170	
FAITOUT BASSE		51, 52	
FAITOUT OVALE		54, 56, 169, 170	
FER À CARAMELISER		319, 405	
FEUILLES		82, 335, 372	
FIL DE CUISINE		82	
FONDUE		58	
FONTAINE CHOCOLAT		264, 388	
FOUET		96, 98, 105, 108, 109, 186, 311, 315	
FOUR		392	
FOURCHETTE		92, 93, 94, 95, 96, 97, 100, 101, 239, 241	
FRITEUSE		374, 375, 376, 377	
FRUTE CENTRIFUGEUSE		415	
FUSIL		238, 241	
<b>G</b>			
GANT		84, 85, 237	
GAUFRIER		387	
GEL CHAUFFE		59, 259	
GRATTOIR		183	
GRILL		52, 72, 74	
GRILL		383, 384, 385	
GRILLE		81, 274, 336	



## FR Index alphabétique

GRILLE PÂTISSERIE	326
GRILLE-PAIN	265, 266, 267, 401, 402, 403, 404, 405
GUIDE DE DIVISION	273
GURIDON PÂTISSIER	144, 326

### H

HACHOIR	118
HACHOIR	118, 229, 230, 231
HACHOIR LÉGUMES	369
HACHOIR POUR VIANDE	366, 367
HOUSSE CHARIOT	282
HOUSSE REFROIDISSEMENT	193
HUILIER	164, 165

### I

INDICATEUR	141
INDICATEUR	305
INDICATEUR RÉSEVÉE	175

### L

LACETS DE CUISINE	82
LAMPE DE CHAUFFAGE	263, 264, 390, 391
LEGUMIERE	174
LOUCHE	92, 94, 95, 96, 97, 98, 99, 148
LOUCHE PERFOREE	92, 148
LOUCHE SAUCE	94, 95, 96, 98, 99

### M

MACHINE À GIVRER LES VERRES	432
MACHINE À GLACE SÈCHE	432
MACHINE À GLASÇONS	430, 431
MACHINE À PAIN	353
MACHINE DE CRÈME GLACÉE	353
MACHINE SOUS VIDE	417, 418, 419, 420
MANCHON	411
MANDOLINE	232, 233, 369
MARMITE	17, 20, 22, 25, 28, 31, 33, 35, 36, 39, 41, 43, 45, 47, 48
MARMITE BASSE	17, 20
MARMITE S. HAUTE	33, 37, 39, 41, 43, 45, 47
MARQUEUR À GATEAUX	326
MARQUEURS TABLEAU	203, 435
MARTEAU	117
MÉLANGEUR	165
MELLETE DE CHEF	241
MESURE À COCKTAIL	198
MESUREUE POUR PÂTES	119
MESUREUR	111, 308
MICRO-ONDES	392, 393
MINI GRILL	57, 171
MINI-CUBE	172
MINUTEUR DE CUISINE	83, 135
MORTIER	120
MOUFLETTE	55, 85
MOULE À BAGUETTE	335
MOULE À CHAUSSONS	117
MOULE À FLAN	335, 337, 339
MOULE À OEUF	110
MOULE À PÂTISSERIE	82, 329, 330, 331, 332, 333, 334, 335, 337, 338, 339, 340, 341, 347
MOULE À PIZZA	338
MOULE POUR CHOCOLATS	343, 344
MOULIN	166, 168, 371
MOUSSEUR À LAIT	398

### N

NAPPE INDIVIDUEL	158, 159
NUMÉROS DE TABLE	175

### O

OEUFS OUVRER	110
OUTILS	313
OUVRE-BOÎTE	223, 243

### P

PALETTE À GÂTEAU	94, 223
PANIER	172, 173
PANIER À COUVERTS	102
PANIER À NID	93
PANIER MARGUERITE	112
PANIER POUR COUVERT	249
PANIER VAPEUR	19, 33, 35, 37, 39, 41, 43, 45, 47, 112
PANIERE	160, 161
PASSOIRE	26, 33, 37, 39, 41, 43, 45, 93, 114, 115, 198
PASSOIRE A FRITURE	113
PASSOIRE SUR PIED	33, 37, 39, 41, 43, 45, 113
PAT À OEUFS	142
PEIGNE À PATE	313
PEIGNE POUR VIANDE	228
PELLE	107
PELLE À FARINE	197, 309
PELLE À POISON	92, 98
PELLE À SALADE	94
PELLE PIZZA	106, 107
PENDERIE MURATE	102
PICHET THERMO	190, 191
PIED POUR RECHAUD	89
PILON	198
PINCE À CASSE-HOMARD	182, 183
PINCE À NAPPE	175
PINCEAU	105, 109, 314, 315
PINCEAU	83, 148, 179, 180, 181, 182, 183, 197, 274, 326
PINCES	83, 183, 274
PISTOLET POUR PÂTISSERIE	325
PLANCHE À DÉCOUPER	244, 245, 246, 247
PLAQUE À FOUR	26
PLAQUE À FOUR	81, 336
PLAQUE À GRILL	73
PLAQUE À INDUCTION	253, 254, 255, 256, 257, 260, 261, 262, 379, 380, 381
PLAQUE POUR CHAUFFANTE	258, 262, 389, 396
PLAT	279
PLAT À ROTIR	21, 26, 80, 81
PLAT E DE CAMPING	142
PLAT ROND	17, 21, 22, 25, 87, 88, 89
PLAT ROND	29, 31, 33, 35, 37, 39, 41, 43, 45
PLATEAU	285
PLATEAU	138, 139, 140, 141, 144, 145, 146, 147, 149, 150, 151, 152, 153, 177
PLATEAU ISOTHERME	284
PLATEAU LIMONADIER	138, 139, 148
POCHE À DECORER	324
PO-CILINDRIQUE	25, 31, 33, 35, 37, 39, 41, 43, 45, 47
POËLE	47, 50, 52, 66, 67, 68, 69, 70, 71, 72, 74, 75, 76, 77
POIRE À JUS	122
POISSONNIÈRE AVEC GRILLE	26
POMPE À VINE	201
PORTE COUVERTS	249
PORTE CURE DENTS	162
PORTE FICHE	285
PORTE-MENU	206, 207, 208, 209, 210, 211, 212, 213, 214, 215, 216, 217, 218, 219
PORTE-SEAU	193
POT À EAU	196, 285
POUBELLE	176, 303
POUSSOIR	347
POUSSOIR À CHINOIS	115
POUSSOIR À MORTIER	120
PRESSE-AGRUMES	123, 406, 407, 408
PRESSE-PAIL	223
PRESSE-PUREE	116, 117
PULVÉRISATEUR	164

### R

RAMASSE-MIETTES	176, 303
RAVIER	142
RAYONNAGE	288, 289, 290, 291, 292, 293, 294, 295, 296
RECHAUD	89
REFROIDISSEUR	430
REFROIDISSEUR À VIN	428, 429

## FR Index alphabétique

---

ROBOT MULTIFONCTIONS	371
RÔTISSOIRE	71
ROULEAU FILM	304
ROULEAU PATISIER	312
ROULETTE PIZZA	107, 229

### S

SACS DE CONSERVATION	421
SALADIER	174
SALAMANDRE	382
SAUCIERE	174
SAUPOUDREUSE	166, 167
SAUTASE CONIQUE	18, 20
SAUTEUSE	18, 21, 23, 33, 47, 50
SCIE À GÂTEAUX	316
SDESSOUS DE BOUTEILLE	142
SEAU	112
SEAU À GLACE	197
SEAU À VIN	193, 194, 195
SÉCHE-MAINS	305
SÉPARATEUR À OEUF	110
SEPARATEUR DE GRAISSE	165
SET CALIÈRE ET POIVIERE	162, 163
SET VINAIGRIE	162, 163
SHAKER	197
SIPHON	126, 320
SIPHON À EAU	196
SONNETTE	175
SOUPIERE	174
SOUS VIDE	424, 425, 427
SOUS-VERRE	142
SPATULA	104, 105, 314, 315
SPATULE LISSE	92, 95, 96, 97, 98, 100, 104, 105, 106, 107, 223, 314, 315
SPATULE PERFOREE	92, 94, 95, 98, 99, 100
SPATULE PIZZA	106
SUCRIER	175, 185
SUPPORT À COUPES	196
SUPPORT CUL DE POULE	112
SUPPORT D'OEUF	110
SUPPORT MAGNETIQUE	242
SUPPORT MENU	175
SUPPORT POUR JAMBON	247
SUPPORT SEAU	193

### T

TABLIER	303
TAMIS	310
TAMIS À FARINE	113
TAPIS	82, 335
THÉIÈRE	185, 188
THERMO	191
THERMOMETRE	101, 132, 133, 134
THERMOTRANS	281
TIRE-BOUCHON	199, 200
TORCHE À CARAMÉLISER	318, 319
TRANCHEUSE DE CHARCUTERIE	368
TRIANGLE	115

### U

USTENSILES DE CUISINE	95, 96
-----------------------	--------

### V

VERRE	285
VIDE-POMMES	223, 224, 227

### W

WOK	35, 50, 70, 72, 77, 262, 379
-----	------------------------------

### Y

YAOURTIÈRE	354
------------	-----

## DE Alphabetisch Index

<b>A</b>			
ABTROPFSCHÜSSEL	33, 37, 39, 41, 43, 45, 113	EITELLER	142
ABTROPFSHÜSSEL FÜR FRITIERTES	113	EI-UNTERSTÜTZUNG	110
ADBECKUNG FÜR TELLERWAGEN	282	ELEKTRITOASTER	265, 266, 267, 401, 402, 403, 404, 405
ANDRÜCKER	347	ELEKTROFLIEGENFÄNGER	436
APFELENTKERNER	223, 224, 227	ELEKTROGRILL	382
ASCHENBECHER	177, 305	ELEKTROKOCHTOPF	352
AUSFSCHNITTMASCHINE	368	ENTBLÄTTERER FÜR GEWÜRZKRÄUTER	119
AUSGIESS-AUFSATZ	200	ESPUMADOR DE LEITE	398
AUSSTELLENDKASTEN, PASTRY	105, 315		
AUSTERMESSER	183, 223	<b>F</b>	
<b>B</b>		FETTABSCHIEDER	165
BACKBLECH	81, 336	FILTERKAFFE	396, 397
BACKBLECH-AUFLAGE	82, 335	FISCHHEBER	92, 98
BACKSCHAUFEL	92, 95, 96, 97, 98, 100, 104, 105, 106, 107, 223, 314, 315	FISCHKESSEL	26
BACKSCHAUFEL , GELOCH	92, 94, 95, 98, 99, 100	FISCHSCHUPPENENTFERNER	183
BAGUETTEFORM	335	FLASCHE VORBEREITUNG VERZIERUNG	165
BAIN MARIE	20, 23, 325, 388, 391	FLASCHENKÜHLER	193
BATLÖFFEL	198	FLASCHENUNTERSETZER	142
BATTERIE, 5-TLG	30	FLEISCHKLOPFER	117
BATTERIE, 8-TLG	32, 34, 36, 38, 40, 42, 44, 46	FLEISCHSPIESSE	102
BESTECK	249	FLEISCHTOPF	16, 19, 22, 24
BESTECKBEHÄLTER	249	FLEISCHWOLF	366, 367
BESTECKKÖCHER	102	FLEISCHZANGE	228
BESTECKKÖCHER	249	FOLIENCUTTER	200
BLACKBLECH	26	FONDUE	58
BLÄTTER	82, 335, 372	FRITEUSE	374, 375, 376, 377
BRATENTOPF	16, 19, 22, 24, 28, 31, 32, 35, 36, 38, 41, 43, 44, 47, 48, 49, 51, 52, 54, 55, 169, 170	FRITIERLÖFFEL	93
BRATENTOPF	51, 52	FRÜHSTÜCKSTELLER	284, 285
BRATPFANNE	21, 26, 80, 81		
BRENNER	319, 405	<b>G</b>	
BRENNPASTE	59, 259	GASANZÜNDER	177
BROT-/OBSTKORB	160, 161	GASKOCHER-STÄNDE	89
BROTBACKMASCHINE	353	GEFLÜGELSCHERE	248
BRULLIERBRENNEN	318, 319	GEMÜSESCHEIDER	369
BRUSH FÜR SCHNEIDEBRETT	246	GEMÜSETOPF	17, 20
BUFFET/SERVIER-PLATTE	142	GETRÄNKEBELHÄLTER	259
BUTTERDOSE MIT DECKEL	174	GETRANKENPENDER	268, 269, 399, 400
<b>C</b>		GETRÄNKESPENDER, ISOLIERT	190, 269, 400
CAMPING TELLER	142	GEWÜRZDOSE/STREUER	166, 167
CHAFING DISH	253, 254, 255, 256, 257, 258	GEWÜRZKASTEN	122
CHAFING HEIZUNG	258, 389	GIESSLÖFFEL, QUER	92
CHAMPAGNERKÜHLE	193, 194, 195	GLAS	285
COCKTAILMASS	198	GLASUNTERSETZER	142
COCKTAILSHARKER	197	GN DECKEL	274, 275, 276
COOKINGME	350, 351	GN ZWISCHENSTENG	273
CRÊPES-PFANNE	71, 72, 76, 386, 387	GN-BEHÄLTER	154, 155, 272, 273, 275, 276, 277, 278
<b>D</b>		GN-BEHÄLTER, PERFORIERT	272, 273
DAMPFKOCH-AUFSATZ	19, 33, 35, 37, 39, 41, 43, 45, 47, 112	GRILL	52, 72, 74
DAMPFKOCHGERÄT	373	GRILL	81, 274, 336
DECKEL	18, 21, 23, 26, 29, 33, 35, 37, 39, 41, 43, 45, 47, 50, 52, 61, 78, 80	GRILL	383, 384, 385
DEKORIEREN DOSIERFLASCHE	121, 325	GRILLPFANNE	326
DEKORIEREN PLASTIKKAMME	313	GRILLSPIß	71
DESENÖFFNER	223, 243	<b>H</b>	
DOPPEL-BODEN	273, 275, 276	HACKFLEISCHMESSER	241
DOSIERER	125, 317	HALTERUNG	285
DOSIERFLASCHE	121, 325	HAMMER	117
DOSIERFLASCHE	198	HÄNDETROCKNER	305
DREIECK	115	HANDSCHUH	55, 85
<b>E</b>		HÄNGELEISTE	102
EIER OPENER	110	HOHER FLEISCHTOPF	33, 37, 39, 41, 43, 45, 47
EIERFORM	110	HOLZ-STÖSSEL	115
EIER-SEPARATOR	110	HONIGBEHÄLTER	166, 267
EIMER	112	HULLE	411
EIS MACHINE	353	HUMMERGABEL	183
EIS MASCHINEN	430, 431	HUMMERZANGE	182, 183
EIS-CRUSHER	197, 431		
EISKELCH	326	<b>I</b>	
EISPORTIONIERER	327	INDIKATOR	141, 305
		INDUKTIONSKOCHFELD	253, 254, 255, 256, 257, 260, 261, 262, 379, 380, 381
		ISOLATIONSKUNGLN FÜR SOUS VIDE	426
		ISOTHERMAL SCHALE/TABLETT	284

# DE Alphabetisch Index

<b>J</b>			
JOGHURT-MAKER			354
<b>K</b>			
KAFFEEKANNE		185, 186, 187	
KÄSEREIBE		118, 229, 230, 231	
KASSEROLLE, BAUCHIG		25	
KETTE		337	
KNOBLAUCHPRESSE		223	
KOCHER		112	
KORB		172, 173	
KORKEN		200	
KORKENZIEHER		199, 200	
KRÄTERKOCHSIEB		112	
KREISEL		124	
KRÜMELBÜRSTE		176, 303	
KÜCHE ZEICHENKETTE		82	
KÜCHENAAGE		128, 129, 130, 131, 308, 378	
KUCHENFORM		82, 329, 330, 331, 332, 333, 334, 335, 337, 338, 339, 340, 341, 347	
KÜCHENHANDSCHUH		84, 85, 237	
KUCHENPLATTE		144, 326	
KUCHENSCHAUFEL		94, 223	
KÜCHENSILIKONBÄNDER		82	
KÜCHEN-ZEITSCHALTUHR		83, 135	
KUSKUSTOPF		112	
<b>L</b>			
LÖFFELSAMMLER IN GESCHIRR			93
<b>M</b>			
MAGNETHALTERUNG FÜR MESSER			242
MANDOLINE		232, 233, 369	
MARKER TAFEL		203, 435	
MASCHINE FUER GLAS COOL		432	
MASCHINE MACHEN TROCKNEIS		432	
MEHLBEHÄLTER		113	
MEHLSCHAUSEL		197, 309	
MEHLSIEB		310	
MENAGE		162, 163	
MENÜKARTENHALTER		175	
MESSER		222, 223, 224, 238, 239, 240, 241, 242	
MESSERHALTER		241, 242	
MESSERTASCHE		241	
MESSGERÄT		111, 308	
METZGERHAKEN		102, 236, 249	
MIKROWELLE		392, 393	
MILCHKANNE		185	
MILCHTOPF		25, 31, 33, 35, 37, 39, 41, 43, 45, 47	
MINI GRILL		57, 171	
MINI-WÜRFEL		172	
MIXER		355, 356, 357, 358, 360, 361, 362, 363, 364, 365, 410, 412, 413, 414	
MOJITOSTÖßSEL		198	
MÖRSER		120	
MULTIFUNKTIONS-ROBOTER		371	
<b>N</b>			
NESTBACKLÖFFEL			93
NUDELKOCH-EINSATZ			33, 37
NUSSKNACKER			183
<b>O</b>			
OBSTTROCKNER		372, 373	
OFEN		392	
ÖLKANNE		164, 165	
ÖL-SPRAY		164	
OVAL BRATENTOPF		54, 56, 169, 170	
<b>P</b>			
PARMESAMENAGE			174
PASSIERGERÄT		116, 117	
PASTETENFORMEN		117	
PFANNE		17, 21, 22, 25, 87, 88, 89	
PFANNE		47, 50, 52, 66, 67, 68, 69, 70, 71, 72, 74, 75, 76, 77	
PFANNE		29, 31, 33, 35, 37, 39, 41, 43, 45	
PINSEL			105, 109, 314, 315
PISTOLE FÜR TÜLLENSATZE			325
PIZZABLECH			338
PIZZAOFEN-SCHAUFEL			106, 107
PIZZASCHNEIDER			107, 229
PIZZASPATEL			106
PLATTE			279
PLATTE GRILL			73
PRALINENGIESSFORM			343, 344
PUDDING-/BECHERFÖRMCHEN			335, 337, 339
<b>R</b>			
RESERVED INDIKATOR			175
REZEPTIONSKLINGEL			175
RINGSTÄNDER			112
ROLLFILM			304
RUHRPATEL			107
RUNGSTOOLS			313
<b>S</b>			
SAFTBEHÄLTER			259
SAHNEBEREITER			126, 320
SALATSCHAUFEL			94
SALATSCHÜSSEL			174
SALZ-PFEFFERTREUER			166, 168, 371
SATZ-PFEFFER-SET			162, 163
SAUCENGLIESSLÖFFEL			94, 95, 96, 98, 99
SAUCIERE			174
SAUTEUSE			18, 21, 23, 33, 47, 50
SAUTEUSE, KONISCH			18, 20
SCHÄLER			119, 225, 228
SCHÄLER			222, 223, 224, 225
SCHÄRFMASCHINE			243, 434
SCHAUFEL			104, 313
SCHAUMLÖFFEL			92, 93, 94, 95, 96, 97, 98, 99
SCHINKENHALTER			247
SCHNEEBESEN			96, 98, 105, 108, 109, 186, 311, 315
SCHNEIDEBRETT			244, 245, 246, 247
SCHNEIDER			222, 223, 225, 226, 227, 228, 370
SCHNELLKOCHTOPF			61, 62, 63, 64
SCHOKOLADEN FONTÄNE			264, 388
SCHÖPFKELLE			92, 94, 95, 96, 97, 98, 99, 148
SCHÖPFKELLE, GELOCHT			92, 148
SCHÜRZE			303
SCHÜSSEL			112, 145, 146, 147, 148, 149, 150, 152, 174, 284, 285, 309
SCHÜSSEL			111, 309
SCHÜSSEL, RUND			279
SCHWEIFSÄGE			316
SEIHER, MIT STIEL			26, 33, 37, 39, 41, 43, 45, 93, 114, 115, 198
SEKTKÜHLER			197
SEKTKÜHLERSTÄNDER			193
SERVIERLÖFFEL			92, 94, 95, 96, 97, 98, 99, 100, 101, 148, 149
SERVIERLÖFFEL, GELOCHT			92, 94, 95, 96, 98, 99, 100, 148
SERVIERSCHÜSSEL			174
SERVIERTABLET			285
SERVIERTABLET			138, 139, 140, 141, 144, 145, 146, 147, 149, 150, 151, 152, 153, 177
SERVIERTABLET			138, 139, 148
SERVIERWAGEN			282, 283, 285
SERVIETTENPENDER			176, 304
SERVIETTENROLLE			304
SET BLEISTIFFE FÜR SCHIEFER			141
SOSENSPRITZE			122
SOUS VIDE			424, 425, 427
SPAGHETTIHEBER			95, 96, 98, 99
SPAGHETTI-MASS			119
SPEISEKARTENMAPPE			206, 207, 208, 209, 210, 211, 212, 213, 214, 215, 216, 217, 218, 219
SPRITZBEUTEL			324
SPÜLKORB			299, 300, 301
STÄNDER EISKELCH			196
STÄNDER FUER BRENNER			89
STERILISIERUNGSSCHANK			434
STIELKASSEROLLE, FRANZÖSISCH			18, 20



## DE Alphabetisch Index

---

STIELKASS., HFLACH 17, 20, 23, 25, 29, 31, 32, 34, 35, 37, 38, 40, 41, 42, 43, 44, 46, 47, 48, 49, 51, 52, 98  
STIELKAS., HOCH 17, 20, 23, 25  
STÖSSEL 120  
SUPPENBEREITER 263, 264, 390, 391, 438, 439, 440, 441  
SUPPENSCHÜSSEL 174  
SUPPENTOPF 17, 20, 22, 25, 28, 31, 33, 35, 36, 39, 41, 43, 45, 47, 48

### T

TAFEL 200, 202, 203, 435  
TASSE 284  
TEEKANNE 185, 188  
TEIGAUSSTECHER 316  
TEIGROLLER 312  
TEIGSCHABER 104, 105, 314, 315  
TELLER 149  
TELLERABDECKUNG 175  
TELLERABDECKUNG 175, 285  
THERMOBEHÄLTER 191  
THERMOMETER 101, 132, 133, 134  
THERMOMOSKANNE 190, 191  
THERMOTRANS 281  
TISCHHALTERUNG 193  
TISCHLÄUFER 159  
TISCHNUMMERN Schild 175  
TISCHSET 158, 159  
TISCHTUCHKLAMMER 175  
TISH-ABFALLBEHÄLTER 176, 303  
TORTENNING 337, 346  
TORTENNING, GELOCHT 345  
TORTENTEILER 326  
TRANCHIERGABEL 92, 93, 94, 95, 96, 97, 100, 101, 239, 241  
TRICHTER 115, 200  
TUBULÄRE REGAL 283  
TÜLLENSATZ 321, 322, 323  
TÜLLENSÄTZESPENDER 317

### U

UNTERSATZ 160

### V

VAKUUM-BEHÄLTER 421  
VAKUUMBEUTEL 421  
VAKUUMBEUTEL ROLLEN 421  
VAKUUMIERGERÄT 417, 418, 419, 420  
VOLLE REGALE 288, 289, 290, 291, 292, 293, 294, 295, 296  
VORLEGETEILE 95, 96

### W

WANDSPENSER SEIFE 305  
WANNE 111  
WÄRMENLAMPE 263, 264, 390, 391  
WARMHALTEPLATTE 258, 262, 389, 396  
WASSER SAHNEBEREITER 196  
WASSERKANNE 196, 285  
WASSERWARMER 187, 394, 395  
WEINKÜHLER 428, 429  
WEINKÜHLER 430  
WEINPUMPE 201  
WEINRING TROP-STOP 200  
WENDEWAFFLEISEN 387  
WETZSTAHL 238, 241  
WOK 35, 50, 70, 72, 77, 262, 379

### Z

ZAHNSTOCHERBÜCHSE 162  
ZANGE 83, 148, 179, 180, 181, 182, 183, 197, 274, 326  
ZANGES 83, 183, 274  
ZELLEHALTER 102  
ZITRUS ENTSAFTER 415  
ZITRUSPRESSE 123, 406, 407, 408  
ZUCKERDOSE 175, 185  
ZWIEBELHACKER 118

# EN Alphabetical index

<b>A</b>			
AIR POT		190, 269, 400	
AIRPOT		268, 269, 399, 400	
APPETIZER DISH		142	
APPLE CORER		223, 224, 227	
ASHTRAY		177, 305	
<b>B</b>			
BAGUETTE MOULD		335	
BAIN MARIE		20, 23, 325, 388, 391	
BAKING SHEET		81, 336	
BASE FOR BURNER		89	
BASKET		172, 173	
BATTER DISPENSER		317	
BATTERY 5 PCS.		30	
BATTERY 8 PCS.		32, 34, 36, 38, 40, 42, 44, 46	
BIRD'S NEST MOULD		93	
BLACKBOARD		200, 202, 203, 435	
BOTTLE COOLER		193	
BOTTLE STAND		142	
BOWL		112, 145, 146, 147, 148, 149, 150, 152, 174, 284, 285, 309	
BOWL SATND		112	
BREAD BASKET		160, 161	
BREAD-MAKING MACHINE		353	
BRUSH		105, 109, 314, 315	
BRUSH FOR CUTTING BOARD		246	
BURNER		89	
BUTCHERS		102, 236, 249	
BUTTER DISH WITH COVER		174	
<b>C</b>			
CAKE MARKER		326	
CAKE SPOON		94, 223	
CAKE STAND		144, 326	
CALL BELL		175	
CAMPING PLATE		142	
CAN OPENER		223, 243	
CAP		200	
CARAMIZER		319, 405	
CASSEROLE		16, 19, 22, 24, 28, 31, 32, 35, 36, 38, 41, 43, 44, 47, 48, 49, 51, 52, 54, 56, 169, 170	
CHAFING DISH		253, 254, 255, 256, 257, 258	
CHAFING HEATER		258, 389	
CHEESE/CAKE COVER		175	
CHINESSE STRAINER PUSHER		115	
CHOCOLATE FOUNTAIN		264, 388	
CHOCOLATE MOULD		343, 344	
CHOPPER		118	
CLEAVER		241	
CLING FILM		304	
COCKTAIL SPOON		198	
COCTAIL SHARKER		197	
COFFEE POT		185, 186, 187	
COFFEE URN		259	
COIL TUBE		421	
COLANDER WITH STAND		33, 37, 39, 41, 43, 45, 113	
COLD MEAT CUTTER		368	
CONDIMENTS HOLDER		122	
CONICAL DISH		111, 309	
CONICAL SAUTE PAN		18, 20	
CONTAINER		154, 155, 272, 273, 275, 276, 277, 278	
CONTAINER LID		274, 275, 276	
COOKIE CUTTER		316	
COOKIE PRESS		325	
COOKINGME		350, 351	
COOK'S CASE		241	
COOLER		430	
CORKSCREW		199, 200	
COUSCOUS POT		112	
COVERING		82, 335	
CREAMER		185	
CREPIERE		71, 72, 76, 386, 387	
CRUET SET		162, 163	
CRUMBS CLEANER		176, 303	
<b>CUP</b>			326
<b>CUP</b>			284
<b>CUPS STAND</b>			196
<b>CUTLERY</b>			249
<b>CUTLERY CYLINDER</b>			249
<b>CUTLERY HOLDER</b>			249
<b>CUTTER</b>			222, 223, 225, 226, 227, 228, 370
<b>CUTTING BOARD</b>			244, 245, 246, 247
<b>CUTTLERY HOLDER</b>			102
<b>CYLINDRICAL POT</b>			25, 31, 33, 35, 37, 39, 41, 43, 45, 47
<b>D</b>			
<b>DECORATING COMBRE</b>			313
<b>DECORATING PEN</b>			121, 325
<b>DEEP CASSEROLE</b>			16, 19, 22, 24
<b>DEEP SAUCEPAN</b>			17, 20, 23, 25
<b>DEEP STOCK POT</b>			33, 37, 39, 41, 43, 45, 47
<b>DEHYDRATOR</b>			372, 373
<b>DINNER PLATE</b>			149
<b>DISH CART COVER</b>			282
<b>DISPENSER</b>			166, 267
<b>DOUBLE BOTTOM</b>			273, 275, 276
<b>DRESSING MIXER BOTTLE</b>			165
<b>DUMPLING MOULD</b>			
<b>E</b>			
<b>EGG OPENER</b>			117
<b>EGG SERVING DISH</b>			110
<b>EGG STAND</b>			142
<b>EGG STAND</b>			110
<b>EGGS SEPARATOR</b>			110
<b>ELECTRIC COOKER</b>			
<b>F</b>			
<b>FILTER COFFE MACHINE</b>			352
<b>FILTER COFFE MACHINE</b>			396, 397
<b>FISH KETTLE WITH GRILL AND LID</b>			26
<b>FISH SCRAPER</b>			183
<b>FISH TURNER</b>			92, 98
<b>FLOUR BIN MESH</b>			113
<b>FOIL CUTTER</b>			200
<b>FONDUE</b>			58
<b>FOOD LOOP</b>			82
<b>FORK</b>			92, 93, 94, 95, 96, 97, 100, 101, 239, 241
<b>FRENCH SAUCEPAN</b>			18, 20
<b>FRY COLANDER</b>			113
<b>FRYER</b>			374, 375, 376, 377
<b>FRYING-PAN</b>			47, 50, 52, 66, 67, 68, 69, 70, 71, 72, 74, 75, 76, 77
<b>FUEL GEL BUCKET</b>			59, 259
<b>FUNNEL</b>			115, 200
<b>G</b>			
<b>GARLIC PRESS</b>			223
<b>GAS LIGHTER</b>			177
<b>GAS TORCH</b>			318, 319
<b>GLASS</b>			285
<b>GLASS COOLER MACHINE</b>			432
<b>GLASS STAND</b>			142
<b>GLOVE</b>			84, 85, 237
<b>GRATER</b>			118, 229, 230, 231
<b>GRAVY BOAT</b>			174
<b>GRAVY LADLE</b>			94, 95, 96, 98, 99
<b>GRAVY/FAT SEPARADOR</b>			165
<b>GRILL</b>			52, 72, 74
<b>GRILL</b>			81, 274, 336
<b>GRILL</b>			383, 384, 385
<b>GRILL PLAQUE</b>			73
<b>GRINDER</b>			166, 168, 371
<b>H</b>			
<b>HAMMER</b>			117
<b>HAM-SUPPORT</b>			247
<b>HAND DRYER</b>			305
<b>HEATING LAMP</b>			263, 264, 390, 391
<b>HERB STRIPPER</b>			119

## EN Alphabetical index

<b>I</b>		<b>P</b>	
ICE BUCKET	197	PAIL	112
ICE CREAM MAKING MACHINE	353	PARMESAN BOWL	174
ICE CREAM SCOOP	327	PASTA COOKER	33, 37
ICE CRUSHER	197, 431	PASTA MEASURER	119
ICE CUBES MAKER	430, 431	PASTRY BAG	324
ICE SHOVEL	197, 309	PASTRY DISPLAY	105, 315
INDEX CARD FASTENER	285	PASTRY MOULD	82, 329, 330, 331, 332, 333, 334, 335, 337, 338, 339, 340, 341, 347
INDICATOR	141	PASTRY RACK	326
INDIVIDUAL PLACEMENT	158, 159	PEELER	222, 223, 224, 225
INDUCTION PLATE	253, 254, 255, 256, 257, 260, 261, 262, 379, 380, 381	PERFORATED CONTAINER	272, 273
ISOTHERMAL TRAY	284	PERFORATED LADLE	92, 148
<b>J</b>		PERFORATED RINGS	345
JIGGER	198	PERFORATED SPATULA	92, 94, 95, 98, 99, 100
JUICE DISPENSER	259	PERFORATED SPOON	92, 94, 95, 96, 98, 99, 100, 148
JUICE EXTRACTOR	415	PESTLE	120
<b>K</b>		PINAFORE	303
KETTLE	187, 394, 395	PIZZA CUTTER	107, 229
KITCHEN STRING	82	PIZZA FLAT SCOOP	106, 107
KITCHEN TIMER	83, 135	PIZZA MOULD	338
KITCHEN TOOL SET	95, 96	PIZZA SPATULA	106
KNIFE	222, 223, 224, 238, 239, 240, 241, 242	PLATE	284, 285
KNIFE BLOC	241, 242	PLATE COVER	175, 285
KNIFE SHARPENER	243, 434	PORTIONNER	125, 317
KNIFE STERILIZATION	434	POTATO MASHING MACHINE	116, 117
<b>L</b>		POURER	198
LADLE	92, 94, 95, 96, 97, 98, 99, 148	PRESSURE COOKER	61, 62, 63, 64
LID	18, 21, 23, 26, 29, 33, 35, 37, 39, 41, 43, 45, 47, 50, 52, 61, 78, 80	PUDDING MOILD	335, 337, 339
LOBSTER CRACKER	182, 183	PUSHER	347
LOW CASSEROLE	51, 52	<b>R</b>	
LOW STOCK POT	17, 20	RACK	299, 300, 301
<b>M</b>		RESERVED SIGNAL	175
MACE	198	RINGS	337, 346
MACHINE MAKE DRY ICE	432	ROASTER	21, 26, 80, 81
MAGNET SUPPORT	242	ROLL DISPENSER	304
MANDOLINE	232, 233, 369	ROLLING PIN	312
MARKERS BLACKBOARD	203, 435	ROTISSERIE	71
MEASURER	111, 308	ROUND	17, 21, 22, 25, 87, 88, 89
MEAT MINCER	366, 367	ROUND DISH	29, 31, 33, 35, 37, 39, 41, 43, 45
MEAT TENDERIZER	117	ROUND INSERT	279
MEAT TONG	228	ROUNDED SAUCEPAN	25
MENU CARD HOLDER	175	RTUBULAR SHELF	283
MENU COVER	206, 207, 208, 209, 210, 211, 212, 213, 214, 215, 216, 217, 218, 219	<b>S</b>	
MESH SKIMMER	93	SALAD BOWL	174
MICROWAVE	392, 393	SALAMANDER	382
MILK FROTHER	398	SALAT SCOOP	94
MINI GRILL	57, 171	SALT-PFEFFER SET	162, 163
MINI-CUBE	172	SAUCE SYRINGE	122
MITTEN	55, 85	SAUCEPAN	17, 20, 23, 25, 29, 31, 32, 34, 35, 37, 38, 40, 41, 42, 43, 44, 46, 47, 48, 49, 51, 52, 93
MIXER	355, 356, 357, 358, 360, 361, 362, 363, 364, 365, 410, 412, 413, 414	SAUTEUSE	18, 21, 23, 33, 47, 50
MIXING BOWL	111	SCALE	128, 129, 130, 131, 308, 378
MORTAR	120	SCISSORS	248
MOSKITO KILLER	436	SCRAPER	104, 313
MULTIFUNCTION ROBOT	371	SEAFOOD FORKS	183
<b>N</b>		SERVICE TROLLEY	282, 283, 285
NAPKIN HOLDER	176, 304	SERVING TRAY	138, 139, 148
NOZZLES	321, 322, 323	SET PENCILS FOR SLATE	141
NUT CRACKER	183	SHAPE EGG MOULD	110
<b>O</b>		SHARKER	166, 167
OIL CAN	164, 165	SHARPENING	238, 241
OIL SPRAYER	164	SHEETS	82, 335, 372
ONE PIECE CROSS SPOOM	92	SHELVING	288, 289, 290, 291, 292, 293, 294, 295, 296
ORDER RALL	102	SHOVEL	107
OUSTER OPENNER	183, 223	SIEVE	310
OVAL CASSEROLE	54, 56, 169, 170	SIGNAL	305
OVEN	392	SKEWERSQUARE	102
OVEN TRAY	26	SKIMMER	92, 93, 94, 95, 96, 97, 98, 99
		SLEEVE	411
		SLICER	119, 225, 228
		SOAP WALL DISPENSER	305
		SOUP HEATER	263, 264, 390, 391, 438, 439, 440, 441

## EN Alphabetical index

---

SOUP-TUREEN	174
SOUS VIDE	424, 425, 427
SOUS VIDE INSULATION BALLS	426
SPAGUETTI SERVER	95, 96, 98, 99
SPATULA	104, 105, 314, 315
SPATULA	92, 95, 96, 97, 98, 100, 104, 105, 106, 107, 223, 314, 315
SPICE COOKER	112
SPINNER	124
SPLITTING GUIDES	273
SPOON	92, 94, 95, 96, 97, 98, 99, 100, 101, 148, 149
SPOON HOLDER UTENSILS	93
SPOUT FOR WINE	200
SQUEEZE BOTTLE	121, 325
SQUEEZER	123, 406, 407, 408
STEAM CASSEROLE	19, 33, 35, 37, 39, 41, 43, 45, 47, 112
STEAM COOKER	373
STEAMER	112
STOCK POT	17, 20, 22, 25, 28, 31, 33, 35, 36, 39, 41, 43, 45, 47, 48
STRAINER	26, 33, 37, 39, 41, 43, 45, 93, 114, 115, 198
SUGAR BOWL	175, 185
SWEDISH SAW	316

### T

TABLE BIN	176, 303
TABLE NUMBERS	175
TABLE RUNNER	159
TABLECLOTH PROTECTOR	160
TABLECLOTHS PEGS	175
TEA POT	185, 188
TERMO JUG	190, 191
THERMO	191
THERMOMETER	101, 132, 133, 134
THERMOTRANS	281
TOASTER	265, 266, 267, 401, 402, 403, 404, 405
TONG	83, 148, 179, 180, 181, 182, 183, 197, 274, 326
TONGS	83, 183, 274
TOOLS	313
TOOTHPICK	162
TRAY	285
TRAY	138, 139, 140, 141, 144, 145, 146, 147, 149, 150, 151, 152, 153, 177
TRAY	279
TRIANGLE	115
TRING	337

### V

VACUUM BAGS	421
VACUUM CANISTERS	421
VACUUM PACK MACHINE	417, 418, 419, 420
VEGETABLE DISH	174
VEGETABLES CUTTER	369
VINE BUCKET	193, 194, 195

### W

WAFFLE MAKER	387
WALL HANGER	102
WARMING PLATE	258, 262, 389, 396
WATER JUG	196, 285
WATER WHIPPER	196
WHIPPER	126, 320
WHISK	96, 98, 105, 108, 109, 186, 311, 315
WINE COOLER	428, 429
WINE DRIP STOP RING	200
WINE STAND	193
WINE TABLE SUPPORT	193
WINE VACUUM SEALER	201
WOK	35, 50, 70, 72, 77, 262, 379

### Y

YOGHURT MAKER	354
---------------	-----



<b>A</b>		CHALEIRA	187, 394, 395
ABERTO-OSTRAS	183, 223	CHÁVENA	284
ABRE-LATAS	223, 243	CINZEIRO	177, 305
AÇUCAREIRO	175, 185	CLOCHE PARA PRATOS	175, 285
AFIADOR DE FACAS	243, 434	CLOQUE PARA QUEIJO/TARTES	175
AIR POT	190, 269, 400	COADOR	26, 33, 37, 39, 41, 43, 45, 93, 114, 115, 198
AIRPOT	268, 269, 399, 400	COBERTO	249
ANILHA ANTI-GOTA	200	COLHER COCKTAIL	198
AQUECEDOR	263, 264, 390, 391, 438, 439, 440, 441	COLHER LISA	92, 94, 95, 96, 97, 98, 99, 100, 101, 148, 149
AQUECEDOR CHAFING	258, 389	COLHER OBLÍQUA	92
AQUECEDOR DE LÍQUIDOS	259	COLHER PERFURADA	92, 94, 95, 96, 98, 99, 100, 148
ARDÓSIA	200, 202, 203, 435	COLHER RECOLHE UTENSÍLIOS	93
ARGAMASSA	120	CONCHA	92, 94, 95, 96, 97, 98, 99, 148
ARMÁRIO ESTERILIZADOR	434	CONCHA PARA MOLHO	94, 95, 96, 98, 99
ARMÁRIO REFRIGERADOR	428, 429	CONCHA PERFURADA	92, 148
ARO	337, 346	CONJUNTO LÁPIS PARA ARDÓSIA	141
ARO PERFURADO	345	COOKINGME	350, 351
ASSADEIRA	21, 26, 80, 81	COPO	285
AVENTAL	303	COPOS PARA TALHERES	102
AZEITEIRA	164, 165	COPOS PARA TALHERES	249
<b>B</b>		CORRE MESA	159
BACIA	112, 145, 146, 147, 148, 149, 150, 152, 174, 284, 285, 309	CORREDOR	197, 309
BACIA	111	CORRENTE	337
BACIA CÓNICA	111, 309	CORTA VEGETALES	369
BACIA DA ENSALADA	174	CORTADOR	222, 223, 225, 226, 227, 228, 370
BALANÇA	128, 129, 130, 131, 308, 378	CORTADORA DE FIAMBRE	368
BALDE	112	CORTA-MASSAS	316
BANDEJA	285	CORTA-PIZZA	107, 229
BANDEJA/TRAVESSA	138, 139, 140, 141, 144, 145, 146, 147, 149, 150, 151, 152, 153, 177	COUSCOUSEIRAR	112
BANDEJA DE SERVIR	138, 139, 148	COZEDOR DE ESPECIARIAS	112
BANDEJA FORNO	26	COZE-MASSAS	33, 37
BANDEJA ISOTÉRMICA	284	CREPEIRA	71, 72, 76, 386, 387
BANHO-MARIE	20, 23, 325, 388, 391	CUTELO	241
BARRA FIXAÇÃO NOTAS	102	<b>D</b>	
BATEDEIRA	355, 356, 357, 358, 360, 361, 362, 363, 364, 365, 410, 412, 413, 414	DESCAPSULADOR	200
BATEDOR	96, 98, 105, 108, 109, 186, 311, 315	DESCAROÇADOR	223, 224, 227
BATERIA 5 PCS.	30	DESCASCADOR	119, 225, 228
BATERIA 8 PCS.	32, 34, 36, 38, 40, 42, 44, 46	DESCASCADOR	222, 223, 224, 225
BLADE ARREFECEDORA DE GARRAFAS	193, 194, 195	DESFOLHADOR DE ERVAS	119
BOBINA DE VÁCUO	421	DESIDRATADOR	372, 373
BOBINA FILME	304	DISIFICADOR LICOR	198
BOMBA VÁCUO	201	DISPENSADOR DE SABÃO	305
BOQUILHA DE SERVIR	200	DISTRIBUIDOR DE PASTELERÍA	317
BOQUILHAS	321, 322, 323	DISTRIBUIDOR ZUMOS	259
BULE	185, 188	DOSIFICADOR	166, 267
<b>C</b>		DOSIFICADOR	125, 317
CAÇAROLA	16, 19, 22, 24, 28, 31, 32, 35, 36, 38, 41, 43, 44, 47, 48, 49, 51, 52, 54, 56, 169, 170	DSECADOR DE MÃO	305
CAÇAROLA A VAPOR	19, 33, 35, 37, 39, 41, 43, 45, 47, 112	DUPLO FUNDO	273, 275, 276
CAÇAROLA ALTA	16, 19, 22, 24	<b>E</b>	
CAÇAROLA ALTA DIREITE	17, 20, 23, 25	EARREFECEDOR DE GARRAFAS	193
CAÇAROLA BAIXA	51, 52	EMPURRADOR	347
CAÇAROLA BOJUDA	25	ESCORREDOR	33, 37, 39, 41, 43, 45, 113
CAÇAROLA CÓNICA	18, 20	ESCORRE-FRITOS	113
CAÇAROLA DIREITE	17, 20, 23, 31, 32, 34, 35, 37, 38, 41, 42, 43, 44, 46, 47, 48, 49, 51, 52, 98	ESCOVA APANHA-MIGALHAS	176, 303
CAÇAROLA OVAL	54, 56, 169, 170	ESCUMADEIRA	92, 93, 94, 95, 96, 97, 98, 99
CAFÉ TIPO FILTRO	396, 397	ESCUMADEIRA	93
CAFETEIRA	185, 186, 187	ESFERAS ISOLANTES SOUS VIDE	426
CAIXA	154, 155, 272, 273, 275, 276, 277, 278	ESMAGA-ALHOS	223
CAIXA CONDIMENTOS	122	ESPÁTULA	104, 105, 314, 315
CAIXA PERFURADA	272, 273	ESPÁTULA DE BOLOS	94, 223
CAIXAS VÁCUO	421	ESPÁTULA DE PEIXE	92, 98
CAMPAINHA	175	ESPÁTULA LISA	92, 95, 96, 97, 98, 100, 104, 105, 106, 107, 223, 314, 315
CANECA CILÍNDRICA	25, 31, 33, 35, 37, 39, 41, 43, 45, 47	ESPÁTULA PERFURADA	92, 94, 95, 98, 99, 100
CAPA PROTECTORA CARRO	282	ESPÁTULA PERFURADA	94
CARRO SERVIÇO	282, 283, 285	ESPÁTULA PIZZA	106
CENTRIFUGADORA	124	ESPÁTULA PIZZA	106, 107
CEPILHO PARA TÁBUA DE CORTE	246	ESPETO MORUNO	102
CESTA	299, 300, 301	ESPETOS PARA MARISCO	183
CESTA	172, 173	ESPREMEDOR	123, 406, 407, 408
CESTA DE PÃO	160, 161	ESPUMADOR DE LEITE	398
CHAFING DISH	253, 254, 255, 256, 257, 258	ESTANTE	288, 289, 290, 291, 292, 293, 294, 295, 296

EXPOSITOR PASTELERIA	105, 315	MÁQUINA PARA FAZER GELADO	353
<b>F</b>		MARCADOR DE BOLOS	326
FAÇA	222, 223, 224, 238, 239, 240, 241, 242	MARCADORES ARDÓSIA	203, 435
FARINHEIRO	113	MARTELO	117
FECHO PARA BANDEJAS	285	MARTELO ABLANDADOR	117
FERRAMENTAS	313	MATA MOSQUITOS	436
FIO DE COZINHA	82	MEDIDOR	111, 308
FONDUE	58	MEDIDOR OARA MACARRAO	119
FONTE CHOCOLATE	264, 388	MICROONDAS	392, 393
FORMA FLAN	335, 337, 339	MINI GRILL	57, 171
FORMA PARA SALGADOS	117	MINI-CUBO	172
FORNO	392	MOINHO	166, 168, 371
FRANCÊS CAÇAROLA	18, 20	MOLDE OVO	110
FRIGIDEIRA	18, 21, 23, 33, 47, 50	MOLDE PARA BOMBONS	343, 344
FRITEDEIRA	374, 375, 376, 377	MOLDE PASTELERÍA	335
FUNIL	115, 200	MOLDE PASTELERÍA	82, 329, 330, 331, 332, 333, 334, 335, 337, 338, 339, 340, 341, 347
FUSIL	238, 241	MOLDE PIZZA	338
<b>G</b>		MOLHEIRA	174
GANCHOS	102, 236, 249	<b>N</b>	
GARFO	92, 93, 94, 95, 96, 97, 100, 101, 239, 241	NINHOS DE ARAME	93
GARRAFA	121, 325	NÚMEROS PARA TABELA	175
GARRAFA DE PREPARAÇÃO ALINO	165	<b>O</b>	
GARRAFA DECORÇÃO	121, 325	OVOS ABRIDOR	110
GARRAFA DOSEADORA	198	<b>P</b>	
GEL COMBUSTÍVEL	59, 259	PÁ	107
GRELHA	112	PAELHEIRA	17, 21, 22, 25, 87, 88, 89
GRELHA	81, 274, 336	PAELHEIRA GÁS BUTANO	89
GRELHA PASTELERIA	326	PALITEIRO	162
GRELHADOR	71	PANELA	17, 20, 22, 25, 28, 31, 33, 35, 36, 39, 41, 43, 45, 47, 48
GRELHADOR	52, 72, 74	PANELA BAIXA	17, 20
GRELHADOR	383, 384, 385	PANELA DE COCÇÃO	373
GUARDANAPO	176, 304	PANELA DE PRESSÃO	61, 62, 63, 64
GUIA DIVISÓRIA	273	PANELA ELÉCTRICA	352
<b>I</b>		PANELA SUPER ALTA	33, 37, 39, 41, 43, 45, 47
INDICADOR	141	PAPELEIRA	176, 303
INDICADOR	305	PARTE-NOZES	183
INDICADOR RESERVADO	175	PASSA-PURÉ	116, 117
INSERTO REDONDO	279	PÉ PORTA BALDES	193
IOGURTEIRA	354	PEGAS	55, 85
ISQUEIRO	177	PEIXEIRA	26
<b>J</b>		PENEIRA	310
JARRA DE ÁGUA	196, 285	PENTE DE DECORAÇÃO	313
JARRA TERMO	190, 191	PICADORA	118
JOGO DE COZINHA	95, 96	PICADORA DE CARNE	366, 367
JOGO GALHETEIRO	162, 163	PICADORA DE GELO	197, 431
JOGO SALEIRO-PIMENTEIRO	162, 163	PILÃO P/ALMOFARIZ	120
<b>L</b>		PILÃO P/PASSADOR CHINÊS	115
LAÇOS DE COZINHA	82	PINÇA	83, 148, 179, 180, 181, 182, 183, 197, 274, 326
LÂMINA	82, 335, 372	PINÇA PARA TOALHAS	175
LÂMPARA CALOR	263, 264, 390, 391	PINÇA/PENTE CORTA-CARNE	228
LEGUMEIRA	174	PINÇAS	83, 183, 274
LEITEIRA	185	PINCEL	105, 109, 314, 315
LIQUIDIFICADORAS	415	PIPETA PARA MOLHO	122
LUVA	84, 85, 237	PISTOLA PASTELERÍA	325
LUVA	411	PLACA AQUECIMIENTO	258, 262, 389, 396
<b>M</b>		PLACA DE FORNO	81, 336
MAÇO	198	PLACA DE INDUÇÃO	253, 254, 255, 256, 257, 260, 261, 262, 379, 380, 381
MALA CHEF	241	PLANCHA GRILL	73
MANDOLINA	232, 233, 369	POLVILHADOR	166, 167
MANGA DE PASTELERIA	324	PORTA MENU	206, 207, 208, 209, 210, 211, 212, 213, 214, 215, 216, 217, 218, 219
MANTEIGUEIRA	174	PORTA-CUBOS GELO	197
MÁQUINA DE FAZER GELO	430, 431	PORTA-ROLOS	304
MÁQUINA DE FAZER GELO SECO	432	PORTA-TARTE	144, 326
MAQUINA DE FAZER GOFFRES	387	POUSA-COPOS	142
MÁQUINA DE FAZER PÃO	353	POUSA-GARRAFAS	142
MÁQUINA DE VACÚO	417, 418, 419, 420	PRATELEIRA TUBULAR	283
MÁQUINA PARA ENFRIAR COPAS	432	PRATINHO	142
		PRATO	284, 285
		PRATO CAMPING	142
		PRATO DE OVOS	142

## PT Índice alfabético

---

PRATO RASO	149
PROTECTOR DE TOALHAS	160
PULVERIZADOR	164

### Q

QUEIJEIRA	174
QUEIMADOR	319, 405
QUEIMADORA A GÁS	318, 319

### R

RACIONADOR DE GELADO	327
RALADOR	118, 229, 230, 231
RASPADOR	104, 313
RASPADOR DE PEIXE	183
REFRIGERADOR	430
RELÓGIO DE COZINHA	83, 135
ROBÔ MULTIFUNCIONAIS	371
ROLO	312

### S

SACA-ROLHAS	199, 200
SACOS DE VÁCUO	421
SALAMANDRA	382
SEPARADOR DE GORDURAS	165
SEPARADOR DE OVOS	110
SERRA SUEXA	316
SERTÃ	47, 50, 52, 66, 67, 68, 69, 70, 71, 72, 74, 75, 76, 77
SERVIDOR ESPARGUETE	95, 96, 98, 99
SHARKER	197
SIFÃO	126, 320
SIFÃO DE ÁGUA	196
SOPEIRA	174
SOUS VIDE	424, 425, 427
SUPORTE BALDE DE ARREFECEDOR	193
SUPORTE DE BACIAS	112
SUPORTE DE BARRA	102
SUPORTE DE OVO	110
SUPORTE DE TAPAS	196
SUPORTE MAGNÉTICO	242
SUPORTE MENÚ	175
SUPORTE PAELHERIA	89
SUPORTE PRESUNTO	247
SUPORTE TALHERES	249

### T

TÁBUA DE CORTE	244, 245, 246, 247
TAÇA	326
TACO FACAS	241, 242
TAMPA	18, 21, 23, 26, 29, 33, 35, 37, 39, 41, 43, 45, 47, 50, 52, 61, 78, 80
TAMPA PARA CAIXA	274, 275, 276
TAMPÃO	200
TAPETE	82, 335
TARTEIRA	29, 31, 33, 35, 37, 39, 41, 43, 45
TENAZ MARISCOS	182, 183
TERMO	191
TERMÓMETRO	101, 132, 133, 134
TESOURAS	248
THERMOTRANS	281
TOALHA DE MESA INDIVIDUAL	158, 159
TORRADEIRA	265, 266, 267, 401, 402, 403, 404, 405
TRAVESSA	279
TRIÂNGULO	115

### W

WOK	35, 50, 70, 72, 77, 262, 379
-----	------------------------------

CGH-01/18



**Lacor Menaje Profesional, S.L.**

Bº San Juan, s/n -Apdo. 18  
20570 Bergara (Guipuzkoa), Spain  
Tel.: (Nacional) +943-76-90-30 / Fax: +943-76-53-87  
Tel.: (Export) +943-76-91-74 / Fax: +943-76-92-22  
comercial@lacor.es / export@lacor.es  
Grupo Marcos Larrañaga y Cia



[www.lacor.es](http://www.lacor.es)