



**MOBILIARIO PARA HOSTELERÍA
Y
COLECTIVIDADES**

2018

ALANA P16



MARGOT P17



VELVET P18



VELOUR P19



CHARLOTTE P20



MÉRIDA P22



BENDER P23



DRINA P24



MORRIS P25



ECOLE P26



SYTTEN P27



TREVI P28



SPARTA P29



JUNO P30



HERA P31



ARLET P32



LAGER P33



NICOLE P34



NINETTE P35



BROOKLYN P36



BRUNA P37



NICE P38



DREAM P39



DORSIA P40



VERSO P40



OSLO P41



GALWAY P42



LAGER P43



DOUGLAS P44



PRESTON P44



MISSY P45



CAVALIER P46



BAT P47



KLOE P48



MINERVA P49



MATILDA P50



DISSET P51



FONTANA P52



COCO P53



SCALA P54



PARÍS P55



MÁLAGA P56



JAVA P57



CARLA P58



LICEO P59



CAPRI V. P60



CAPRI P. P61



ACHE P62



TEBAS P63



CÓRCEGA P64



MEDAS P64



VERAMAR P65



KIOTO P66



PALLET P67



OASIS P68



VÉRTEX P69



BENDER P70



MARGOT P71



AERO P72



CHARLOTTE P73



SYTTEN P74



MÉRIDA P75



MIU P76



HIRO P77



TREVI P78



MORRIS P79



VICO P80



LAGER P81



FONTANA P82



MINERVA P83



PALLET P84



PORTO P85



KIOTO P86



APOLO P87



YOKO P88



YOKO AP. P89



TIMÓN P90



BITTER P91



BENDER P92



BIMBA P93



POP P94



BÁSICA P95



TRÉBOL P96



MIU P97



LAGER P98



NINA P99



AVANGARD P100



VIENA P101



MAX P102



EQUIX P103



CLICK P104



SEVILLA P105



FEDRA P106



VELA P107



KATER P108



ALZA P109



FLEXIT P110



LAGER P111



LAGER P112



P.RÍGIDO P113



PARAV.TÉXTIL P114



BIOMBO P115



MÓNACO P117



PINO P117



PINO RUSTIK P117



MDF P116



MDF IBERO P116



HARRY VINTAGE P116



CP MARINO ABEDUL P118



CP MARINO ABEDUL IBERO P118



CALACATTA P118



CP MARINO ESTRAT. P118



CP MARINO INOX P119



CP MARINO INOX REPUL. P119



COMPACT P119



COMPACT IBERO P120



ACERO Y ALUMINIO / ALUMINIUM & STEEL / ALUMINIUM ET ACIER

PINTURA / PAINT / PEINT



Tratamiento de fosfatado y pintura poliéster 100% polvo.

Phosphating treatment and 100% polyester powder coating paint.

Traitement phosphate et 100% peinture polyester en poudre.

PINTURA VINTAGE / VINTAGE PAINT / PEINT VINTAGE



Envejecido a mano de la pintura y posterior aplicación de barniz de poliuretano en polvo.
Antique finish handmade and subsequent application of polyurethane varnish powder coating .

Peinture vieillie a la main et application ultérieure d'un vernis polyuréthane en poudre.

BARNIZ INDUSTRIAL / INDUSTRIAL VARNISHED / BRUT VERNI

ACERO / STEEL / ACIER

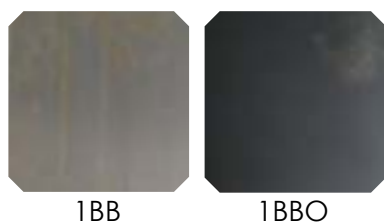

ALUMINIO / ALUMINIUM



Fosfatado y barnizado poliéster en polvo sobre el acero o aluminio con acabado industrial.
Puede presentar irregularidades superficiales como rallas, manchas de oxidación y soldadura.
Steel phosphating treatment and polyester varnish powder coating. Surface irregularities such as scratches or oxidation and welding spots.

Acier et aluminium avec traitement phosphate et vernis de polyester en poudre. Probable de présenter irrégularités de surface telles que des rayures, tâches d'oxydation et de soudure.

ACERO Y ALUMINIO / ALUMINIUM & STEEL / ALUMINIUM ET ACIER

MARTELÉ / HAMMERED / MARTELÉE

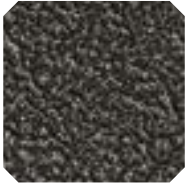

1MT BLACK



2MT COPPER

ALUMINIO ANODIZADO / ANODIZED ALUMINIUM / ALUMINIUM ANODISÉ



1PM

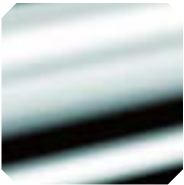

1PB

TAPIZADO / UPHOLSTERY / REMBOURRAGE



ISTOL
BLANCO



ISTOL
HIELO



ISTOL
TIERRA

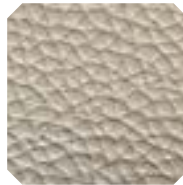

ISTOL
ARENA

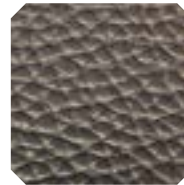

ISTOL
MARRON

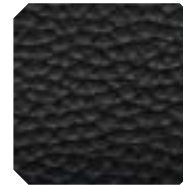

ISTOL
NEGRO



ISTOL
ROJO



VULCANO
BLANCO



VULCANO
BEIGE



VULCANO
TAUPE



VULCANO
GRIS



VULCANO
CHOCO



VULCANO
NEGRO



VULCANO
ANTRACITA



VULCANO
ROJO

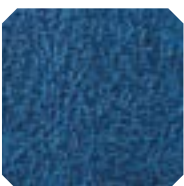

AGNELLI
KLEIN



AGNELLI
BLANCO



AGNELLI
PIEDRA



AGNELLI
CUERO



AGNELLI
PLOMO



VACARELLO
MOSTAZA



VACARELLO
OCRE



VACARELLO
BUFALO



VACARELLO
TURQUESA



PIELTECH
625 PREMIUM



VELVET PLUS
9 ROSA



VELVET PLUS
33 GRANATE



VELVET PLUS
12 VERDE



PROFESS
OXFORD EXPRESO

MADERA / WOOD / BOIS

BARNIZ VINTAGE / VINTAGE VARNISHED / VERNI VINTAGE



1MB RAL9010 2MB RAL5015 3MB RAL3000 4MB RAL6033 5MB NOGAL

BARNIZ / VARNISHED / VERNI



6MB RAL9005 7MB WENGUÉ 8MB NOGAL 9MB NATURAL 10MB BURN 11MB BICOLOR 12MB RAL9010



15MB RAL1015 16MB RAL6027 17MB RAL8012 19MB RAL3015

TRENZADO / WOVEN / TRESSÉ



FSA 1TF BLANCO FSA 2TF AZUL FSA 3TF ROJO FSA 4TF VERDE FSA 5TF BEIGE FSA 6TF BURDEOS FSA 7TF NEGRO



FSA 8TF MARRON FSA 9TF MARINO FSA 13TF GRIS FSM 2TN MARRON FSM 3TN GRIS FSA MIX 1TX NATURAL FSA MIX 3TX VERDE



FSA MIX 4TX AZUL FSA MIX 5TX GRIS FIBRA VINTAGE 1TE 1TD 2TD 3TD 4TD



YUTE 1TS

COMPACT & ESTRATIFICADO



TEXTILENE

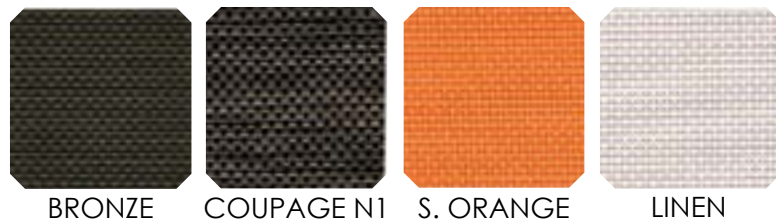

PVC

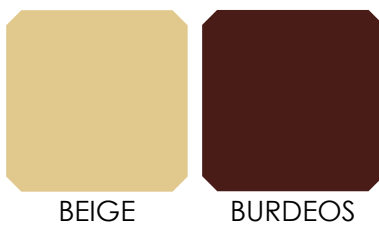

POLIPROPILENO Y POLIAMIDA / POLYPROPYLENE & POLYAMIDE



ALANA



ALANA 18PL + 9MB

Estructura de acero pintado o barnizado, asiento y respaldo de madera, en cualquiera de nuestros acabados. **Uso interior** (tratamiento opcional, previa consulta, para uso exterior).

Painted or varnished steel structure, wood seat & back, in any of our finishes. **Indoor use** (optional treatment, check before, for outdoor use).

Structure en acier peint ou verni, assise et dossier en bois, dans l'une de nos finitions. **Usage intérieur** (traitement optionnel, après consultation, pour usage extérieur).

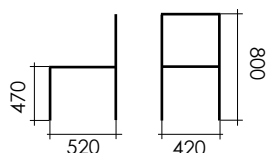

1. 16PL + 8MB
2. 17PL + 9MB



MARGOT



1. MARGOT 1BB + Agnelli Cuero / 2. MAX 8PL (P102) + PINO 5MB (P117) / 3. SYTTEN 1BB + Agnelli Cuero (P74)

Estructura de acero pintado o barnizado, asiento de madera o tapizado, en cualquiera de nuestros acabados. **Uso interior** (tratamiento opcional, previa consulta, para uso exterior, excepto tapizado).

Painted or varnished steel structure, wood or upholstery seat, in any of our finishes. **Indoor use** (optional treatment, check before, for outdoor use, except upholstery).

Structure en acier peint ou verni, assise en bois ou rembourrage, dans l'une de nos finitions. **Usage intérieur** (traitement optionnel, après consultation, pour usage extérieur, sauf rembourré).

MARGOT COLLECTION

Taburete / stool / tabouret P71

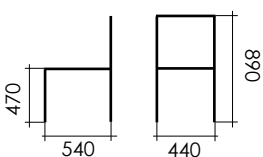

1. 1VI + 1MB
2. 1BB + Velvet Plus 12 verde

*Asiento de madera o tapizado / Wood or upholstery seat / Assise en bois ou rembourrage.

VELVET



1. VELVET 1VI+1MB+1MB / 2. BÁSICA 1VI (P95) + MDF IBERO 1MB (P117)

Patas de acero pintado o barnizado, respaldo de madera, asiento de madera o tapizado, en cualquiera de nuestros acabados. **Uso interior** (tratamiento opcional, previa consulta, para uso exterior, excepto tapizado).

Painted or varnished steel legs, wood back, wood or upholstery seat, in any of our finishes. **Indoor use** (optional treatment, check before, for outdoor use, except upholstery).

Pattes en acier peint ou verni, dossier en bois, assise en bois ou rembourrage, dans l'une de nos finitions. **Usage intérieur** (traitement optionnel, après consultation, pour usage extérieur, sauf rembourré).

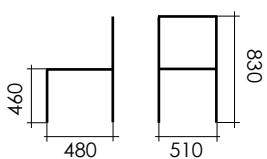

1.

2.



1. 1BB + 5MB + 5MB

2. 1VI + 1MB + Agnelli Klein

*Asiento de madera o tapizado / Wood or upholstery seat / Assise en bois ou rembourrage.

VELOUR

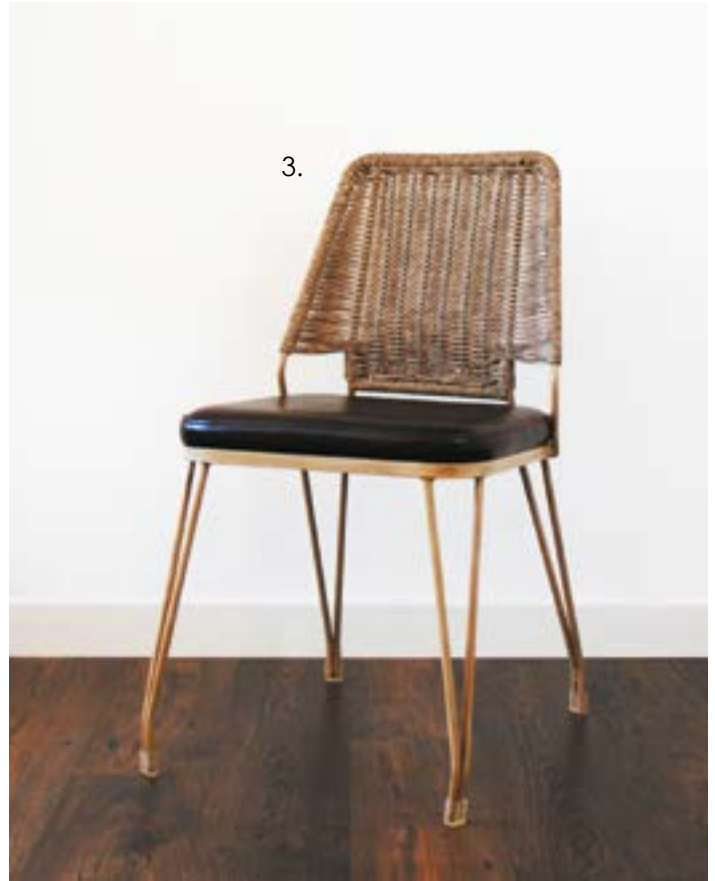

1. VELOUR 1BB + 2TN + 5MB / 2. BENDER DOBLE 1BB (P92) + MDF 5MB (P117) / 3. VELOUR 5VI + 2TN + NUBE 320

Patas de acero pintado o barnizado, respaldo trenzado, asiento de madera o tapizado, en cualquiera de nuestros acabados. **Uso interior** (tratamiento opcional, previa consulta, para uso exterior, excepto tapizado).

Painted or varnished steel legs, woven back, wood or upholstery seat, in any of our finishes. **Indoor use** (optional treatment, check before, for outdoor use, except upholstery).

Pattes en acier peint ou verni, dossier tressé, assise en bois ou rembourrage, dans l'une de nos finitions. **Usage intérieur** (traitement optionnel, après consultation, pour usage extérieur, sauf rembourré).

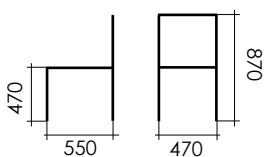

1. 1VI + 3TN + 5MB
2. 5VI + 2TN + Agnelli Blanco

*Asiento de madera o tapizado / Wood or upholstery seat / Assise en bois ou rembourrage.

CHARLOTTE



CHARLOTTE 1BBO + 1TS + 5MB IBERO

Silla y sillón, estructura de acero pintado o barnizado, asiento de madera, respaldo de varilla o trenzado, en cualquiera de nuestros acabados. **Uso interior** (tratamiento opcional, previa consulta, para uso exterior).

Chair & armchair, painted or varnished steel structure, wood seat, rod or woven back, in any of our finishes. **Indoor use** (optional treatment, check before, for outdoor use).

Chaise et fauteuil, structure en acier peint ou verni, assise en bois, tige ou tressé dossier, dans l'une de nos finitions. **Usage intérieur** (traitement optionnel, après consultation, pour usage extérieur).

CHARLOTTE COLLECTION

Taburete / stool / tabouret P73

1.

2.

3.

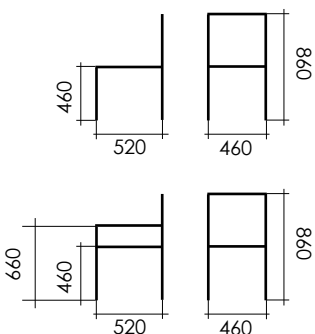

* Silla y sillón, respaldo de varilla o trenzado / Chair & armchair, rod or woven back / Chaise et fauteuil, tige ou tressé dossier

1. 17PL + 9MB / 2. 1BB + 1TS + 5MB IBERO / 3. 18PL + 1TS + 5MB



CHARLOTTE 1MT + 10MB BURN

MÉRIDA



1. MÉRIDA 1BBO / 2. MERIDA 2MT / 3. MERIDA 1MT

Estructura de acero pintado o barnizado, en cualquiera de nuestros acabados. **Uso interior** (tratamiento opcional, previa consulta, para uso exterior).

Painted or varnished steel structure. **Indoor use** (optional treatment, check before, for outdoor use).

Structure en acier peint ou verni. **Usage intérieur** (traitement optionnel, après consultation, pour usage extérieur).

MÉRIDA COLLECTION

Taburete / stool / tabouret P75

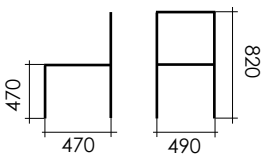

1MT

BENDER



1. BENDER 1BBO + 5MB / 2. VELVET 1BBO + 5MB + 5MB (P18)

Estructura de acero pintado o barnizado, asiento opcional de madera, en cualquiera de nuestros acabados. **Uso interior** (tratamiento opcional, previa consulta, para uso exterior).

Painted or varnished steel structure, optional wood seat, in any of our finishes. **Indoor use** (optional treatment, check before, for outdoor use).

Structure en acier peint ou verni, assise optionnel en bois. dans l'une de nos finitions. **Usage intérieur** (traitement optionnel, après consultation, pour usage extérieur).

BENDER COLLECTION

Taburete / stool / tabouret P70

Mesa / table P92

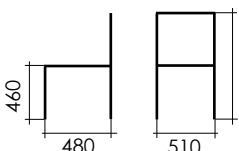

1. 1VI + 4MB / 2. 5PL / 3. 2MT

*Asiento de madera opcional / Optional wood seat / Assise en bois optionnel.

DRINA



1. DRINA 4VI / 2. BENDER 5PL (P23)

Estructura de acero pintado o barnizado, en cualquiera de nuestros acabados. **Uso interior** (tratamiento opcional, previa consulta, para uso exterior).

Painted or varnished steel structure. **Indoor use** (optional treatment, check before, for outdoor use).

Structure en acier peint ou verni. **Usage intérieur** (traitement optionnel, après consultation, pour usage extérieur).

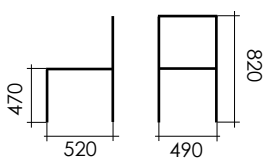

1. 1VI / 2. 3VI

MORRIS



1. MORRIS 1BB + 2MB / 2. BENDER 1BB (P92) + MDF 1MB (P117)

Estructura de acero pintado o barnizado, asiento de madera o acero, en cualquiera de nuestros acabados. **Uso interior** (tratamiento opcional, previa consulta, para uso exterior). Apilable.

Painted or varnished steel structure, wood or steel seat, in any of our finishes. **Indoor use** (optional treatment, check before, for outdoor use). Stackable

Structure en acier peint ou verni, assise en bois ou acier. dans l'une de nos finitions. **Usage intérieur** (traitement optionnel, après consultation, pour usage extérieur). Empilable

MORRIS COLLECTION

Taburete / stool / tabouret P79

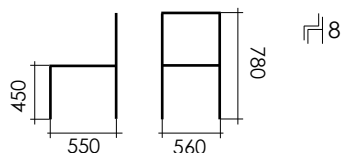

1. 4VI + 4MB
2. 3VI



*Asiento de madera o acero / Wood or steel seat / Assise en bois ou acier.

ÉCOLE



1. ÉCOLE 1BB + 5MB / 2. BÁSICA 7PL (P95) + PINO 10MB Burn (P117)

Estructura de acero pintado o barnizado, asiento y respaldo de madera, en cualquiera de nuestros acabados. **Uso interior** (tratamiento opcional, previa consulta, para uso exterior). Apilable.

Painted or varnished steel structure, wood seat & back, in any of our finishes. **Indoor use** (optional treatment, check before, for outdoor use). Stackable.

Structure en acier peint ou verni, assise et dossier en bois, dans l'une de nos finitions. **Usage intérieur** (traitement optionnel, après consultation, pour usage extérieur, sauf rembourré). Empilable.

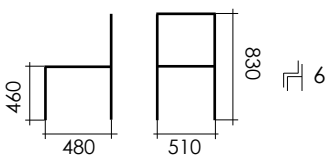

1. 7PL + 1MB / 2. 1BB + 5MB

SYTTEN



1. SYTTEN 1VI + 3MB / 2. VIENA 1VI (P101) + CP MARINO ABEDUL 3MB (P118)

Silla y sillón, estructura de acero pintado o barnizado, respaldo y asiento de madera o tapizado, en cualquiera de nuestros acabados. **Uso interior** (tratamiento opcional, previa consulta, para uso exterior, excepto tapizado). Apilable.

Chair & armchair, painted or varnished steel structure, wood or upholstery seat & back, in any of our finishes. **Indoor use** (optional treatment, check before, for outdoor use, except upholstery). Stackable.

Chaise et fauteuil, structure en acier peint ou verni, assise et dossier en bois ou rembourrage, dans l'une de nos finitions. **Usage intérieur** (traitement optionnel, après consultation, pour usage extérieur, sauf rembourré). Empilable.

SYTTEN COLLECTION

Taburete / stool / tabouret P74

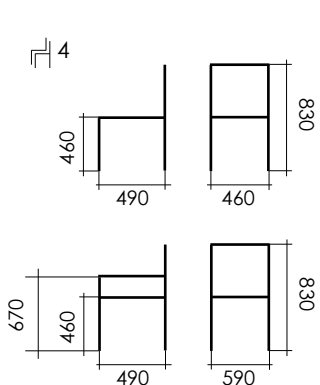

* Silla y sillón, asiento y respaldo de madera o tapizado / Chair & armchair, wood or upholstery seat & back / Chaise et fauteuil, assise et dossier en bois ou rembourrage.

1. 4VI + 4MB / 2. 1BB + Agnelli Blanco / 3. 1BB + 9MB / 4. 1BB + Velvet plus 33 granate

TREVI



TREVI 1VI + VACARELLO BÚFALO

Silla y sillón, estructura de acero pintado o barnizado, respaldo y asiento de madera o tapizado, en cualquiera de nuestros acabados. **Uso interior** (tratamiento opcional, previa consulta, para uso exterior, excepto tapizado). Apilable.

Chair & armchair, painted or varnished steel structure, wood or upholstery seat & back, in any of our finishes. **Indoor use** (optional treatment, check before, for outdoor use, except upholstery). Stackable.

Chaise et fauteuil, structure en acier peint ou verni, assise et dossier en bois ou rembourrage, dans l'une de nos finitions. **Usage intérieur** (traitement optionnel, après consultation, pour usage extérieur, sauf rembourré). Empilable.

TREVI COLLECTION

Taburete / stool / tabouret P78



SPARTA



SPARTA 1VI + Pieltech Premium 625

Estructura de acero pintado o barnizado, respaldo y asiento de madera o tapizado, en cualquiera de nuestros acabados. **Uso interior** (tratamiento opcional, previa consulta, para uso exterior, excepto tapizado). Apilable.

Painted or varnished steel structure, wood or upholstery seat & back, in any of our finishes. **Indoor use** (optional treatment, check before, for outdoor use, except upholstery). Stackable.

Structure en acier peint ou verni, assise et dossier en bois ou rembourrage, dans l'une de nos finitions. **Usage intérieur** (traitement optionnel, après consultation, pour usage extérieur, sauf rembourré). Empilable.

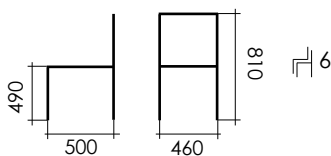

1.



2.



1. 5VI + 1MB

2. 1BB + Velvet plus 12 verde

*Asiento y respaldo de madera o tapizado / Wood or upholstery seat & back /
Assise et dossier en bois ou rembourrage.

JUNO



JUNO 17PL + 9MB

Estructura de acero pintado o barnizado, asiento y respaldo de madera, en cualquiera de nuestros acabados. **Uso interior** (tratamiento opcional, previa consulta, para uso exterior).

Painted or varnished steel structure, wood seat & back, in any of our finishes. **Indoor use** (optional treatment, check before, for outdoor use).

Structure en acier peint ou verni, assise et dossier en bois, dans l'une de nos finitions. **Usage intérieur** (traitement optionnel, après consultation, pour usage extérieur).

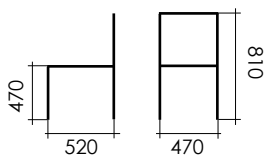

1. 13PL + 8MB
2. 15PL + 7MB



HERA



HERA 15PL + 8MB

Estructura de acero pintado o barnizado, asiento y respaldo de madera, en cualquiera de nuestros acabados. **Uso interior** (tratamiento opcional, previa consulta, para uso exterior).

Painted or varnished steel structure, wood seat & back, in any of our finishes. **Indoor use** (optional treatment, check before, for outdoor use).

Structure en acier peint ou verni, assise et dossier en bois, dans l'une de nos finitions. **Usage intérieur** (traitement optionnel, après consultation, pour usage extérieur).

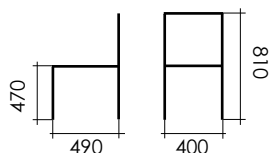

1. 18PL + 9MB
2. 1BB + 8MB



ARLET



ARLET 5PL + 5MB

Estructura de acero pintado o barnizado, respaldo y asiento de madera o tapizado, en cualquiera de nuestros acabados. **Uso interior** (tratamiento opcional, previa consulta, para uso exterior, excepto tapizado).

Painted or varnished steel structure, wood or upholstery seat & back, in any of our finishes. **Indoor use** (optional treatment, check before, for outdoor use, except upholstery).

Structure en acier peint ou verni, assise et dossier en bois ou rembourrage, dans l'une de nos finitions. **Usage intérieur** (traitement optionnel, après consultation, pour usage extérieur, sauf rembourré).

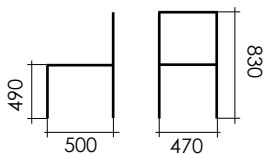

1. 5VI + 5MB
2. 1VI + Agnelli Klein

*Asiento y respaldo de madera o tapizado /
Wood or upholstery seat & back / Assise et dossier
en bois ou rembourrage.



LAGER



LAGER 1BBO + 9MB

Estructura de acero pintado o barnizado, respaldo y asiento de madera o tapizado, en cualquiera de nuestros acabados. **Uso interior** (tratamiento opcional, previa consulta, para uso exterior, excepto tapizado).

Painted or varnished steel structure, wood or upholstery seat & back, in any of our finishes. **Indoor use** (optional treatment, check before, for outdoor use, except upholstery).

Structure en acier peint ou verni, assise et dossier en bois ou rembourrage, dans l'une de nos finitions. **Usage intérieur** (traitement optionnel, après consultation, pour usage extérieur, sauf rembourré).

LAGER COLLECTION

Sofá P43

Taburete / stool / tabouret P81

Mesa / table P98

Estantería / Shelving / Etagère P111

Carrito / Service cart / chariot de service P112

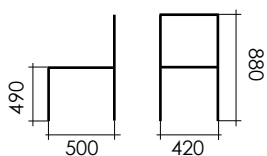

*Asiento y respaldo de madera o tapizado / Wood or upholstery seat & back / Assise et dossier en bois ou rembourrage.

1. 1BBO + 9MB / 2. 1VI + Vacarello ocre

NICOLE



NICOLE 9MB + 1MT + COJÍN "BIG" VELVET PLUS 9 ROSA

Patas de acero pintado o barnizado, respaldo de madera y asiento tapizado, en cualquiera de nuestros acabados. Cojín "Big" o "Small". **Uso interior.**

Painted or varnished steel legs, wood back & upholstery seat, in any of our finishes. "Big" or "Small" cushion. **Indoor use.**

Pattes en acier peint ou verni, assise en bois et dossier en rembourrage, dans l'une de nos finitions. Coussin "Big" ou "Small" **Usage intérieur.**

NICOLE COLLECTION

Silla Ninette / Ninette chair / chaise Ninette P35

Mesa Nina / Nina table / table Nina P99

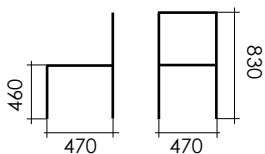

1. 9MB + 1PL + "Small" Vacarello ocre
2. 8MB + 13PL + "Small" Vacarello turquesa

NINETTE



NINETTE 5MB + 2MT + COJÍN "BIG" VELVET PLUS 12 VERDE

Patas de acero pintado o barnizado, respaldo de madera y asiento tapizado, en cualquiera de nuestros acabados. Cojín "Big" o "Small". **Uso interior.**

Painted or varnished steel legs, wood back & upholstery seat, in any of our finishes. "Big" or "Small" cushion. **Indoor use.**

Pattes en acier peint ou verni, assise en bois et dossier en rembourrage, dans l'une de nos finitions. Coussin "Big" ou "Small" **Usage intérieur.**

NINETTE COLLECTION

Silla Nicole / Nicole chair / chaise Nicole P34

Mesa Nina / Nina table / table Nina P99

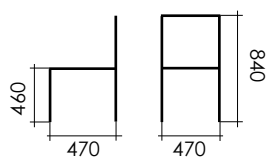

1. 8MB + 5PL + "Small" Vacarello búfalo
2. 9MB + 13PL + "Small" Vacarello ocre

BROOKLYN



BROOKLYN 1BB + 1MB

Patas de acero pintado o barnizado, asiento de madera, en cualquiera de nuestros acabados. **Uso interior** (tratamiento opcional, previa consulta, para uso exterior). Apilable.

Painted or varnished steel legs, wood seat, in any of our finishes. **Indoor use** (optional treatment, check before, for outdoor use). Stackable.

Pattes en acier peint ou verni, assise en bois, dans l'une de nos finitions. **Usage intérieur** (traitement optionnel, après consultation, pour usage extérieur). Empilable.

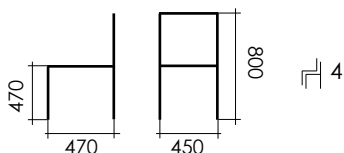

1. 5VI + 5MB
2. 4VI + 4MB



BRUNA



1. BRUNA 5MB / 2. BENDER 1BB (P70) + PINO 5MB (P117)

Estructura, asiento y respaldo de madera, en cualquiera de nuestros acabados. **Uso interior** (tratamiento opcional, previa consulta, para uso exterior).

Wood structure, seat & back, in any of our finishes. **Indoor use** (optional treatment, check before, for outdoor use).

Structure, assise et dossier en bois, dans l'une de nos finitions. **Usage intérieur** (traitement optionnel, après consultation, pour usage extérieur).

1.



2.

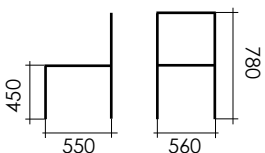

1. 3MB
2. 1MB

NICE



1. NICE 1PM + 7MB / 2. MAX 10PL (P102)

Patas de acero pintado o barnizado, asiento de madera, en cualquiera de nuestros acabados. **Uso interior** (tratamiento opcional, previa consulta, para uso exterior). Apilable.

Painted or varnished steel legs, wood seat, in any of our finishes. **Indoor use** (optional treatment, check before, for outdoor use). Stackable.

Pattes en acier peint ou verni, assise en bois, dans l'une de nos finitions. **Usage intérieur** (traitement optionnel, après consultation, pour usage extérieur). Empilable.

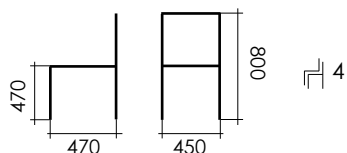

1. 1VI + 1MB
2. 5VI + 2MB

DREAM



1. DREAM 1PB / 2. VELA 1PB (P107)

Patas de aluminio anodizado o barnizado, asiento de madera, en cualquiera de nuestros acabados.

Uso interior (tratamiento opcional, previa consulta, para uso exterior). Apilable.

Anodized or varnished aluminium legs, wood seat, in any of our finishes. **Indoor use** (optional treatment, check before, for outdoor use). Stackable.

Pattes en aluminium anodisé ou verni, assise en bois, dans l'une de nos finitions. **Usage intérieur** (traitement optionnel, après consultation, pour usage extérieur). Empilable.

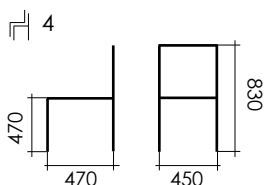

1. 1PM + 9MB
2. 1PM + 6MB



DORSIA - VERSO



1. VERSO 7MB + AGNELLI CUERO / 2. LAGER 1BBO (P98) + COMPACT F2200 D.CHOCO (P119) / 3. DORSIA 7MB + AGNELLI CUERO

Patas de madera, asiento tapizado, en cualquiera de nuestros acabados. **Uso interior.**

Wood legs, upholstery seat, in any of our finishes. **Indoor use.**

Pattes en bois, assise en rembourré, dans l'une de nos finitions. **Usage intérieur.**

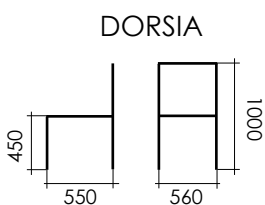
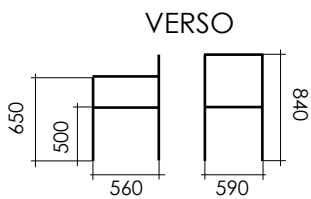

1. DORSIA - 7mb + Vulcano gris
2. VERSO - 7MB + Agnelli cuero



OSLO



OSLO 5MB

Estructura, asiento y respaldo de madera, en cualquiera de nuestros acabados. **Uso interior** (tratamiento opcional, previa consulta, para uso exterior).

Wood structure, seat & back, in any of our finishes. **Indoor use** (optional treatment, check before, for outdoor use).

Structure, assise et dossier en bois, dans l'une de nos finitions. **Usage intérieur** (traitement optionnel, après consultation, pour usage extérieur).

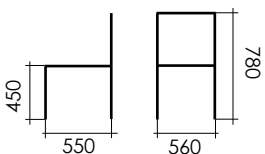

1. 2MB
2. 4MB



GALWAY



GALWAY 5MB + Nube 310 marrón claro

Base de madera, asiento tapizado, en cualquiera de nuestros acabados. Medidas personalizables. **Uso interior.**

Wood base, upholstery seat, in any of our finishes. Personalized measures. **Indoor use.**

Base en bois, assise en rembourré, dans l'une de nos finitions. Fabrication sur mesure. **Usage intérieur.**



1. GALWAY 5MB + Nube 310 marrón claro / 2. BASICA 7PL (P955) + PINO 5MB (P117) / 3. BENDER 1BB + Nube 310 marrón claro (P23)

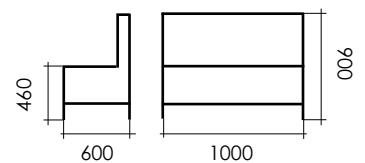
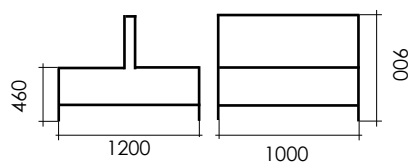

LAGER



1. LAGER 1BB + 10MB burn + Agnelli blanco / 2. LAGER 1BB (P98) + PINO 10MB burn (P117) / 3. LAGER 1BB + Agnelli blanco (P81)

Patas de acero, base de acero o madera, asiento tapizado, en cualquiera de nuestros acabados. Medidas personalizables. **Uso interior.**

Steel legs, steel or wood base, upholstery seat, in any of our finishes. Personalized measures. **Indoor use.**

Pattes en acier, base en acier ou bois, assise en rembourré, dans l'une de nos finitions. Fabrication sur mesure. **Usage intérieur.**

LAGER COLLECTION

Silla / chair / chaise P33

Taburete / stool / tabouret P81

Mesa / table P98

Estanteria / Shelving / Etagère P111

Carrito / Service cart / chariot de service P112

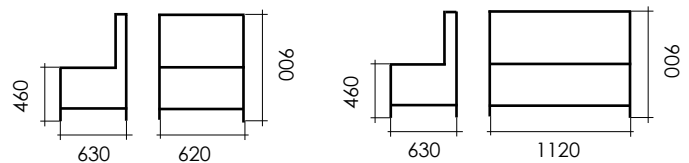

* Base de acero o madera / Steel or wood base / Base en acier ou bois
1. 1BBO + Vacarello turquesa
2. 1VI + 1MB + Agnelli Blanco

DOUGLAS - PRESTON



1. DOUGLAS Vulcano gris / 2. BENDER 3PL (P70)



1. PRESTON Istol negro / 2. BENDER 3VI (P92) + COMPACT IBERO (P120)

Asiento tapizado, en cualquiera de nuestros acabados. Dimensiones personalizables. **Uso interior.**

Upholstery seat, in any of our finishes. Personalizable dimensions. **Indoor use.**

Assise rembourré, dans l'une de nos finitions. Dimensions personalizables. **Usage intérieur.**

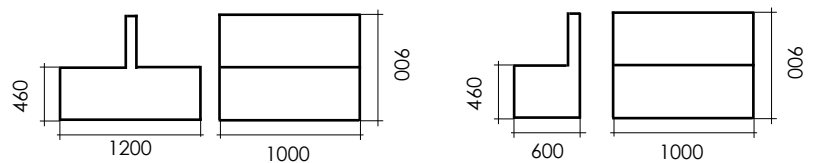

MISSY



1. MISSY 7MB + VELVET PLUS 9 ROSA / 2. NINA 1BB (P99) + CALACATTA (P118)
Patas de madera, asiento tapizado, en cualquiera de nuestros acabados. **Uso interior.**

Wood legs, upholstery seat, in any of our finishes. **Indoor use.**

Pattes en bois, assise rembourré, dans l'une de nos finitions. **Usage intérieur.**

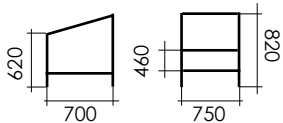

1.



2.



1. 8MB + Agnelli blanco
2. 8MB + Nube 310 marrón oscuro

CAVALIER



1. CAVALIER 9MB + Agnelli Klein / 2. LAGER 1VI (P98) + MDF IBERO 2MB (P117) / 3. MISSY 7MB + Agnelli blanco (P45)

Patas de madera, asiento tapizado, en cualquiera de nuestros acabados. **Uso interior.**

Wood legs, upholstery seat, in any of our finishes. **Indoor use.**

Pattes en bois, assise rembourré, dans l'une de nos finitions. **Usage intérieur.**

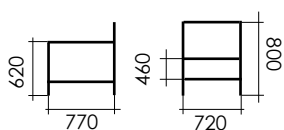

1. 9MBI + Nube 320 marrón oscuro
2. 9MB + Agnelli klein

BAT



1. BAT 9MB + 15PP / 2. BAT 9MB + 17PP / 3. BAT 9MB + 13PP / 4. BÁSICA3 4PL (P95) + MDF 5MB (P117)

Patas de madera o aluminio mate, asiento de polipropileno en cualquiera de nuestros acabados. **Uso interior** con patas de madera (tratamiento opcional, previa consulta, para uso exterior), **uso exterior** con patas de aluminio. Apilable.

Wood or matt aluminium legs, polypropylene seat in any of our finishes. With wood legs **indoor use** (optional treatment, check before, for outdoor use), with aluminium legs **outdoor use**. Stackable.

Pattes en bois ou aluminium mat, assise polypropylène, dans l'une de nos finitions. **Usage intérieur** avec pattes en bois (traitement optionnel, après consultation, pour usage extérieur), **usage extérieur** avec pattes en aluminium. Empilable.

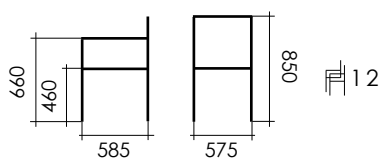

* Patas de aluminio o madera / Aluminium or wood legs / Pattes en aluminium ou bois

1. 1PB + 7PP / 2. 9MB + 17PP

KLOE



1. KLOE 9MB + 16PP / 2. KLOE 9MB + 15PP / 3. KLOE 9MB + 13PP / 4. LAGER 1VI (P98) + MDF IBERO 1VI (P117)

Patas de madera o aluminio mate, asiento de polipropileno, en cualquiera de nuestros acabados. **Uso interior** con patas de madera (tratamiento opcional, previa consulta, para uso exterior), **uso exterior** con patas de aluminio. Apilable.

Wood or matt aluminium legs, polypropylene seat, in any of our finishes. With wood legs **indoor use** (optional treatment, check before, for outdoor use), with aluminium legs **outdoor use**. Stackable.

Pattes en bois ou aluminium mat, assise polypropylène, dans l'une de nos finitions. **Usage intérieur** avec pattes en bois (traitement optionnel, après consultation, pour usage extérieur), **usage extérieur** avec pattes en aluminium. Empilable.

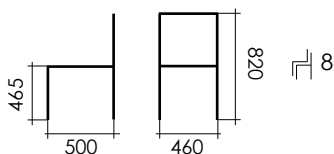

* Patas de aluminio o madera / Aluminium or wood legs / Pattes en aluminium ou bois

1. 1PM + 5PP
2. 9MB + 15PP



MINERVA



1. MINERVA 1PL / 2. POP 1AI (P94) + COMPACT (P119)

Silla y sillón, estructura de aluminio pintado o barnizado, en cualquiera de nuestros acabados. **Uso exterior.**

Chair & armchair, painted or varnished aluminium structure, in any of our finishes. **Outdoor use.**

Chaise et fauteuil, structure en aluminium peint ou verni, dans l'une de nos finitions. **Usage extérieur.**

MINERVA COLLECTION

Taburete / stool / tabouret P83

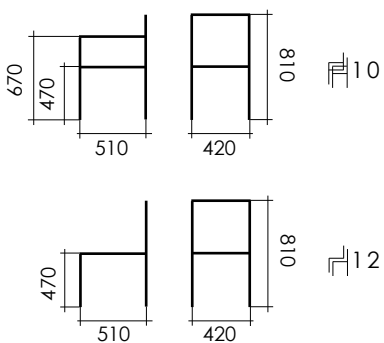

1. 4VI
2. 7PL

* Silla y sillón / Chair & armchair /
Chaise et fauteuil



MATILDA



MATILDA 15PL

Silla y sillón, estructura de aluminio pintado o barnizado, en cualquiera de nuestros acabados. **Uso exterior.**

Chair & armchair, painted or varnished aluminium structure, in any of our finishes. **Outdoor use.**

Chaise et fauteuil, structure en aluminium peint ou verni, dans l'une de nos finitions. **Usage extérieur.**

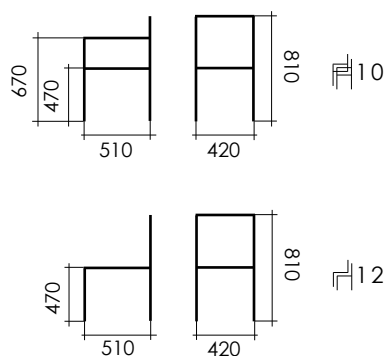

1. 15PL
2. 16PL



DISSET



1. DISSET 1PL + 2TD / 2. BENDER 1PL (P92) + COMPACT F3091 CRYSTAL WHITE (P119)

Estructura de aluminio pintado o barnizado, respaldo de varilla o trenzado, en cualquiera de nuestros acabados. **Uso exterior.** Apilable.

Painted or varnished aluminium structure, dipstick or woven back, in any of our finishes. **Outdoor use.** Stackable.

Structure en aluminium peint ou verni, dossier en tige ou tressé, dans l'une de nos finitions. **Usage extérieur.** Empilable.

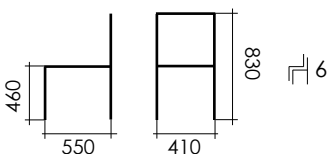

*Respaldo de varilla o trenzado / Dipstick or woven back / Dossier en tige ou tressé.

1. 5PL / 2. 1BB + 3td

FONTANA



FONTANA 1VI

Silla y sillón, estructura de aluminio pintado o barnizado, asiento y respaldo de chapa lisa o trenzada, en cualquiera de nuestros acabados. **Uso exterior.** Apilable.

Chair & armchair, painted or varnished aluminium structure. smooth or braided design seat & back, in any of our finishes. **Outdoor use.** Stackable.

Chaise et fauteuil, structure en aluminium peint ou verni. dans l'une de nos finitions. **Usage extérieur.** Empilable.

FONTANA COLLECTION

Taburete / stool / tabouret P82

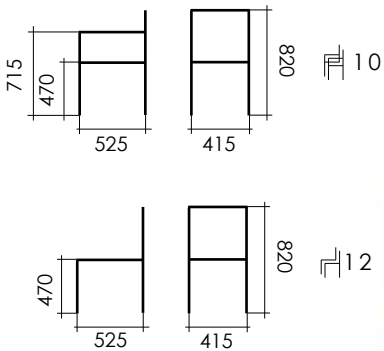

* Silla y sillón, asiento y respaldo en chapa lisa o trenzada / Chair & armchair, seat & back in / Chaise et fauteuil, assise et dossier en plaque lise ou tressé

1. 3PL / 2. 1VI / 3. 16PL / 4. 17PL

COCO



1. COCO 1VI / 2. DRINA 1VI (P24)

Silla y sillón, estructura de aluminio pintado o barnizado, en cualquiera de nuestros acabados. **Uso exterior.** Apilable.

Chair & armchair, painted or varnished aluminium structure. in any of our finishes. **Outdoor use.** Stackable.

Chaise et fauteuil, structure en aluminium peint ou verni. dans l'une de nos finitions. **Usage extérieur.** Empilable.

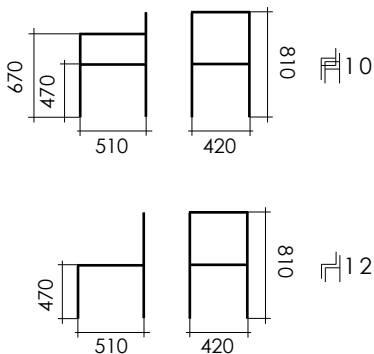

1. 1VI + 1TX
2. 13PL + 3TX

* Silla y sillón / Chair & armchair / Chaise et fauteuil.
1. 3VI / 2. 4VI

SCALA



1. SCALA 1PL + 9TF / 2. DISSET 1PL + 2TD (P51) / 3. JAVA 12PL + 12TF (P57) / 4. BENDER 1PL (P92) + COMPACT F3091 CRYSTAL WHITE (P119)

Silla y sillón, estructura de aluminio barnizado o pintado, asiento y respaldo trenzado, en cualquiera de nuestros acabados. **Uso exterior.** Apilable.

Chair & armchair, varnished or painted aluminium structure, woven seat & back, in any of our finishes. **Outdoor use.** Stackable.

Chaise et fauteuil. structure en aluminium verni ou peint, assise et dossier tressé, dans l'une de nos finitions. **Usage extérieur.** Empilable.

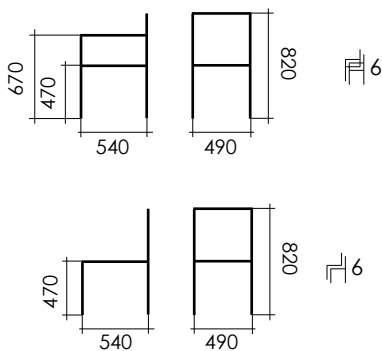

1. 1PL + 2TN
2. 1PL + 9TF

* Silla y sillón / Chair & armchair /
Chaise et fauteuil.



PARÍS



PARÍS 17PL + 1TX

Estructura de acero pintado, asiento y respaldo trenzado, en cualquiera de nuestros acabados. **Uso exterior.** Apilable.

Painted steel structure, woven seat & back, in any of our finishes. **Outdoor use.** Stackable.

Structure en acier peint, assise et dossier tressé. dans l'une de nos finitions. **Usage extérieur.** Empilable.

1.



2.

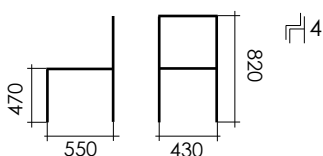

1. 1VI + 1TX
2. 13PL + 3TX

MÁLAGA



MÁLAGA 1PB + 5TF

Estructura de aluminio anodizado, asiento y respaldo trenzado, en cualquiera de nuestros acabados.

Uso exterior. Apilable.

Anodized steel structure, woven seat & back, in any of our finishes. **Outdoor use.** Stackable.

Structure en aluminium anodisé, assise et dossier tressé, dans l'une de nos finitions. **Usage extérieur.**

Empilable.

1.



2.

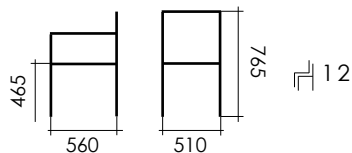

1. 1PB + 11TF / 2. 1PM + Bicolor 5TF - 8TF

JAVA



JAVA 1PB + 5TF

Estructura de aluminio anodizado o pintado, asiento y respaldo trenzado, en cualquiera de nuestros acabados. **Uso exterior.** Apilable.

Anodized or painted aluminium structure, woven seat & back, in any of our finishes. **Outdoor use.** Stackable.

Structure en aluminium anodisé ou peint, assise et dossier tressé, dans l'une de nos finitions. **Usage extérieur.** Empilable.

1.



2.

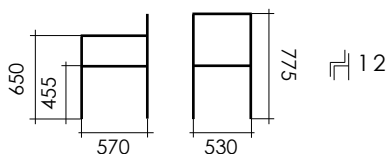

* Estructura anodizada o pintada / Anodized or painted structure / Structure anodisé ou peint

1. 1PB + Bicolor 3TF - 7TF / 2. 18PL + 1TX

CARLA



CARLA 1PB + Bicolor 1TF - 9TF

Estructura de aluminio anodizado o pintado, asiento y respaldo trenzado, en cualquiera de nuestros acabados. **Uso exterior.** Apilable.

Anodized or painted aluminium structure, woven seat & back, in any of our finishes. **Outdoor use.** Stackable.

Structure en aluminium anodisé ou peint, assise et dossier tressé, dans l'une de nos finitions. **Usage extérieur.** Empilable.

1.



2.



12

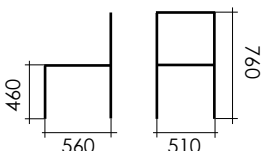

1. 5PL + 1TX

2. 1PL + 3TX

LICEO



LICEO crema

Estructura de aluminio anodizado o pintado, en cualquiera de nuestros acabados. **Uso exterior.** Apilable.

Anodized or painted aluminium structure, in any of our finishes. **Outdoor use.** Stackable.

Structure en aluminium anodisé ou peint, dans l'une de nos finitions. **Usage extérieur.** Empilable.

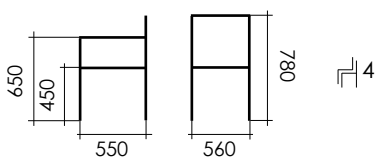

* Estructura anodizada o pintada / Anodized or painted structure / Structure anodisé ou peint

1. 1PB / 2. 1VI

CAPRI VINTAGE



CAPRI VINTAGE 4VI + 1TE

Estructura de aluminio barnizado o pintado, asiento y respaldo trenzado, en cualquiera de nuestros acabados. **Uso exterior.** Apilable.

Varnished or painted aluminium structure, woven seat & back, in any of our finishes. **Outdoor use.** Stackable.

Structure en aluminium verni ou peint, assise et dossier tressé, dans l'une de nos finitions. **Usage extérieur.** Empilable.

1.



2.

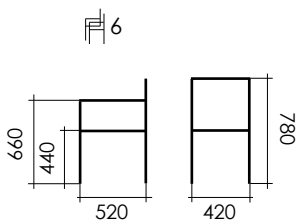

1. 3VI + 1TE / 2. 4VI + 1TE

CAPRI PLUS



1. CAPRI PLUS 1VI + 3TN / 2. CAPRI VINTAGE 4VI + 1TE (P60) / 3. KIOTO 1PL + 9MB (P86)

Estructura de aluminio barnizado o pintado, asiento y respaldo trenzado, en cualquiera de nuestros acabados. **Uso exterior.** Apilable.

Varnished or painted aluminium structure, woven seat & back, in any of our finishes. **Outdoor use.** Stackable.

Structure en aluminium verni ou peint, assise et dossier tressé, dans l'une de nos finitions. **Usage extérieur.** Empilable.

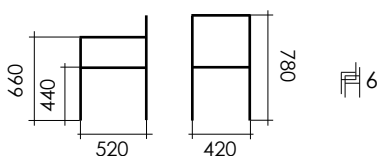

1. 5VI + 2TN / 2. 1VI + 3TN

ACHE



ACHE 3PL - 1PL

Estructura de aluminio anodizado o pintado, en cualquiera de nuestros acabados. **Uso exterior.** Apilable.

Anodized or painted aluminium structure, in any of our finishes. **Outdoor use.** Stackable.

Structure en aluminium anodisé ou peint, dans l'une de nos finitions. **Usage extérieur.** Empilable.



* Estructura anodizada o pintada / Anodized or painted structure / Structure anodisé ou peint

1. 1PB / 2. 4PL

TEBAS



1. *TEBAS* 1PB / 2. *FEDRA* 1PB (P106)

Estructura de aluminio anodizado o pintado, en cualquiera de nuestros acabados. **Uso exterior.** Apilable.

Anodized or painted aluminium structure, in any of our finishes. **Outdoor use.** Stackable.

Structure en aluminium anodisé ou peint, dans l'une de nos finitions. **Usage extérieur.** Empilable.

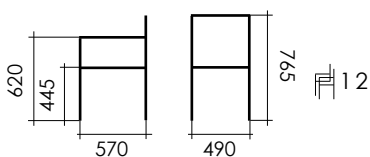

* Estructura anodizada o pintada / Anodized or painted structure / Structure anodisé ou peint

1. 1PB / 2. 8PL

CÓRCEGA - MEDAS



1. CÓRCEGA 1PB + 9PP / 2. MEDAS 1PB + 9PP

Estructura de aluminio anodizado o pintado, tablillas de aluminio o polipropileno, en cualquiera de nuestros acabados. **Uso exterior.** Apilable.

Anodized or painted aluminium structure, aluminium or polypropylene slats, in any of our finishes. **Outdoor use.** Stackable.

Structure en aluminium anodisé ou peint, lattes en aluminium ou polypropylène, dans l'une de nos finitions. **Usage extérieur.** Empilable.

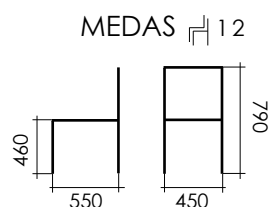
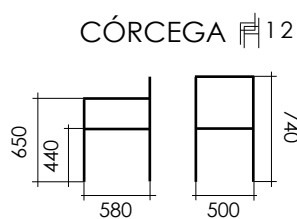

* Tablillas de aluminio o polipropileno/ Aluminium or polypropylene slats / Lattes en aluminium ou polypropylène.

1. Córcega 1PB / 2. Córcega 7PL + 7PP/ 3. Medas 1PB / 4. Medas 4PL + 1PP

VERAMAR



VERAMAR 1PM + 8PP

Estructura de aluminio anodizado, asiento de polipropileno, en cualquiera de nuestros acabados. **Uso exterior.** Apilable.

Anodized aluminium structure, polypropylene seat, in any of our finishes. **Outdoor use.** Stackable.

Structure en aluminium anodisé, assise en polypropylène, dans l'une de nos finitions. **Usage extérieur.** Empilable.

1.



2.



12

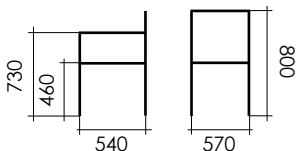

- 1. 1PM + 5PP
- 2. 1PM + 2PP

KIOTO



KIOTO 7PP + 5MB

Silla y sillón, estructura de aluminio pintado, tablillas en aluminio o madera, en cualquiera de nuestros acabados. **Uso exterior.** Apilable.

Chair & armchair, painted aluminium structure, aluminium or wood slats, in any of our finishes. **Outdoor use.** Stackable.

Chaise et fauteuil, structure en aluminium peint, lattes en aluminium ou bois, dans l'une de nos finitions. **Usage extérieur.** Empilable.

KIOTO COLLECTION

Taburete / stool / tabouret P86



PALLET



1. PALLET 1PM + 9MB / 2. PALLET 1PM + 9MB (P84)

Silla y sillón, estructura de aluminio anodizado, tablillas en madera, en cualquiera de nuestros acabados. **Uso exterior.** Apilable.

Chair & armchair, anodized aluminium structure, wood slats, in any of our finishes. **Outdoor use.** Stackable.

Chaise et fauteuil, structure en aluminium anodisé, lattes en bois, dans l'une de nos finitions. **Usage extérieur.** Empilable.

PALLET COLLECTION

Taburete / stool / tabouret P84

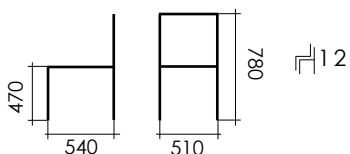
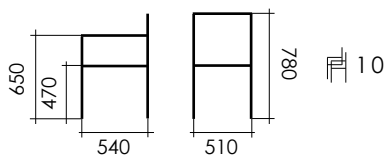

* Silla y sillón / Chair & armchair / Chaise et fauteuil.

1. 1PM + 5MB / 2. 1PM + 9MB + STAMP

OASIS



1. OASIS 1PB + 7PP

Silla y sillón, estructura de aluminio anodizado, asiento y reposabrazos de polipropileno, en cualquiera de nuestros acabados. **Uso exterior.** Apilable.

Chair & armchair, anodized aluminium structure, polypropylene seat & arm rest, in any of our finishes. **Outdoor use.** Stackable.

Chaise et fauteuil, structure en aluminium anodisé, assise & repoussé en polypropylène, dans l'une de nos finitions. **Usage extérieur.** Empilable.

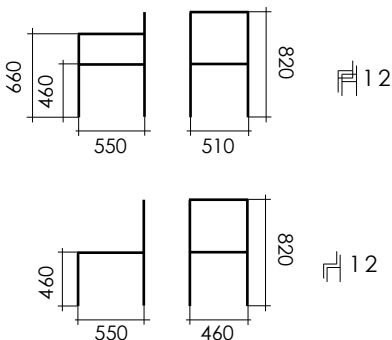

* Silla y sillón / Chair & armchair / Chaise et fauteuil.

1. 1PM + 3PP / 2. 1PM + 1PP

VERTEX



1. VERTEX 1PB + 9PP / 2. AVANGARD 1PB (P100) + CP MARINO INOX ARO 1PB (P119)

Estructura de aluminio anodizado, asiento y reposabrazos de polipropileno, en cualquiera de nuestros acabados. **Uso exterior.** Apilable.

Anodized aluminium structure, polypropylene seat & arm rest, in any of our finishes. **Outdoor use.** Stackable.

Structure en aluminium anodisé, assise & repoussé en polypropylène, dans l'une de nos finitions. **Usage extérieur.** Empilable.

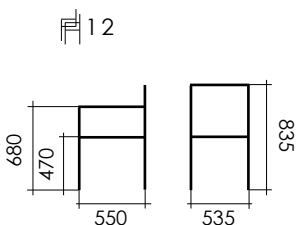

1. 1PB + 7PP
2. 1PB + 5PP



BENDER



BENDER 1VI / 1VI + 5MB / 1VI + 1MB

Alto y mini, estructura de acero pintado o barnizado, asiento opcional de madera, en cualquiera de nuestros acabados. **Uso interior** (tratamiento opcional, previa consulta, para uso exterior).

High & mini, painted or varnished steel structure, optional wood seat, in any of our finishes. **Indoor use** (optional treatment, check before, for outdoor use).

Haut et mini, structure en acier peint ou verni, assise optionnel en bois. dans l'une de nos finitions. **Usage intérieur** (traitement optionnel, après consultation, pour usage extérieur).

BENDER COLLECTION

Silla / chair / chaise P23

Mesa / table P92

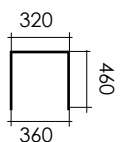
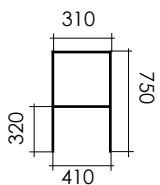

*Asiento de madera opcional, alto y mini / Optional wood seat, high & mini / Assise en bois optionnel, haut et mini.

1. 1PL / 2. 3PL + 5MB / 3. 5VI / 4. 4VI + 4MB

MARGOT

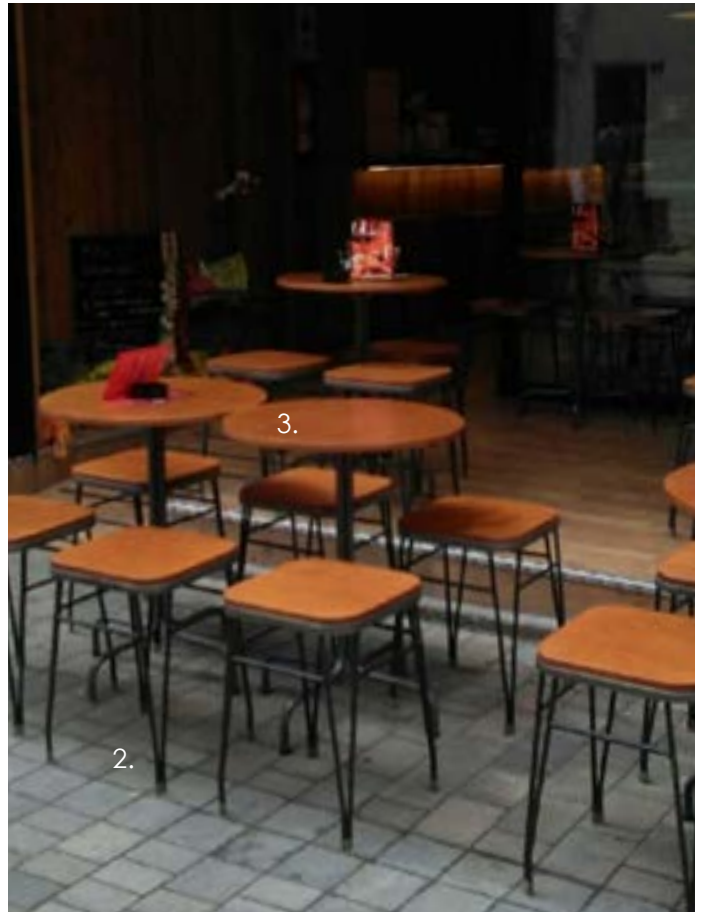

1. MARGOT 1BB + Agnelli Cuero / 2. MARGOT MINI1BB / 3. MIU 1BB (P97) + CP MARINO ABEDUL (P118)

Estructura de acero pintado o barnizado, asiento de madera o tapizado, en cualquiera de nuestros acabados. **Uso interior** (tratamiento opcional, previa consulta, para uso exterior, excepto tapizado).

Painted or varnished steel structure, wood or upholstery seat, in any of our finishes. **Indoor use** (optional treatment, check before, for outdoor use, except upholstery).

Structure en acier peint ou verni, assise en bois ou rembourrage, dans l'une de nos finitions. **Usage intérieur** (traitement optionnel, après consultation, pour usage extérieur, sauf rembourré).

MARGOT COLLECTION

Silla / chair / chaise P17

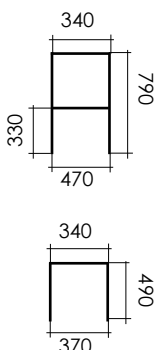

*Asiento de madera o tapizado, alto y mini / Wood or upholstery seat, high & mini / Assise en bois ou rembourrage, haut et mini.

1. 1BB + 5MB / 2. 1VI + Agnelli Klein / 3. 1VI + 1MB / 4. 5VI + Agnelli Piedra

AERO



1. AERO 1BB + 5MB / 2. BRUNA 5MB (P37)

Estructura de acero pintado o barnizado, asiento y respaldo de madera, en cualquiera de nuestros acabados. **Uso interior** (tratamiento opcional, previa consulta, para uso exterior).

Painted or varnished steel structure, wood seat & back, in any of our finishes. **Indoor use** (optional treatment, check before, for outdoor use).

Structure en acier peint ou verni, assise et dossier en bois, dans l'une de nos finitions. **Usage intérieur** (traitement optionnel, après consultation, pour usage extérieur).

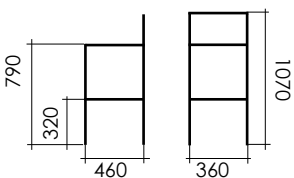

1. 1PL + 12MB
2. 1BB + 9MB

CHARLOTTE



1. CHARLOTTE 16PL + 9MB / 2. CHARLOTTE 17PL + 9MB

Alto y mini, estructura de acero pintado o barnizado, asiento de madera, en cualquiera de nuestros acabados. **Uso interior** (tratamiento opcional, previa consulta, para uso exterior).

High & mini, painted or varnished steel structure, wood seat, in any of our finishes. **Indoor use** (optional treatment, check before, for outdoor use).

Haut et mini, structure en acier peint ou verni, assise en bois, dans l'une de nos finitions. **Usage intérieur** (traitement optionnel, après consultation, pour usage extérieur).

CHARLOTTE COLLECTION

Silla / chair / chaise P20

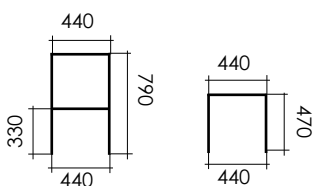

*Alto y mini / High & mini / Haut et mini.

1. 1BB + 9MB / 2. 18PL + 9MB



SYTTEN



SYTTEN 1BB + Nube 320 marrón oscuro

Estructura de acero pintado o barnizado, respaldo y asiento de madera o tapizado, en cualquiera de nuestros acabados. **Uso interior** (tratamiento opcional, previa consulta, para uso exterior, excepto tapizado)

Painted or varnished steel structure, wood or upholstery seat & back, in any of our finishes. **Indoor use** (optional treatment, check before, for outdoor use, except upholstery).

Structure en acier peint ou verni, assise et dossier en bois ou rembourrage, dans l'une de nos finitions. **Usage intérieur** (traitement optionnel, après consultation, pour usage extérieur, sauf rembourré).

SYTTEN COLLECTION

Silla / chair / chaise P27

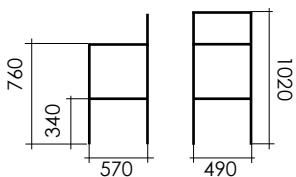

1.



2.



1. 1BB + 9MB + STAMP / 2. 1VI + Agnelli Piedra

* Asiento y respaldo de madera o tapizado / Wood or upholstery seat & back / Assise et dossier en bois ou rembourrage.

MÉRIDA



MÉRIDA 1BBO

Estructura de acero pintado o barnizado, en cualquiera de nuestros acabados. **Uso interior** (tratamiento opcional, previa consulta, para uso exterior)

Painted or varnished steel structure, in any of our finishes. **Indoor use** (optional treatment, check before, for outdoor use).

Structure en acier peint ou verni, dans l'une de nos finitions. **Usage intérieur** (traitement optionnel, après consultation, pour usage extérieur).

MÉRIDA COLLECTION

Silla / chair / chaise P22

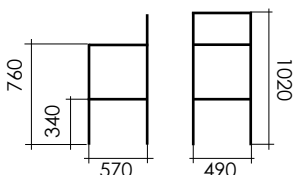

1BBO



MIU



MIU 1VI + 10MB BURN

Estructura de acero pintado o barnizado, asiento de madera o tapizado, en cualquiera de nuestros acabados. **Uso interior** (tratamiento opcional, previa consulta, para uso exterior, excepto tapizado)

Painted or varnished steel structure, wood or upholstery seat, in any of our finishes. **Indoor use** (optional treatment, check before, for outdoor use, except upholstery).

Structure en acier peint ou verni, assise en bois ou rembourrage, dans l'une de nos finitions. **Usage intérieur** (traitement optionnel, après consultation, pour usage extérieur, sauf rembourré).

MIU COLLECTION

Mesa / table P97

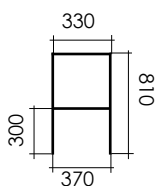

1. 1VI + 9MB + STAMP / 2. 1VI + Velvet Plus 9 Rosa

* Asiento de madera o tapizado / Wood or upholstery seat / Assise en bois ou rembourrage.

HIRO



HIRO 1BB + 5MB

Estructura de acero pintado o barnizado, asiento de madera, en cualquiera de nuestros acabados. **Uso interior** (tratamiento opcional, previa consulta, para uso exterior).

Painted or varnished steel structure, wood seat, in any of our finishes. **Indoor use** (optional treatment, check before, for outdoor use).

Structure en acier peint ou verni, assise et dossier en bois, dans l'une de nos finitions. **Usage intérieur** (traitement optionnel, après consultation, pour usage extérieur).

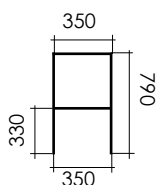

1.



2.



1. 1BB + 5MB

2. 1BB + 9MB

TREVI



TREVI 1BB + 1MB

Estructura de acero pintado o barnizado, respaldo y asiento de madera, o combinado acero y madera, en cualquiera de nuestros acabados. **Uso interior** (tratamiento opcional, previa consulta, para uso exterior).

Painted or varnished steel structure, wood or steel & wood combined seat & back, in any of our finishes. **Indoor use** (optional treatment, check before, for outdoor use).

Structure en acier peint ou verni, assise et dossier en bois, ou acier et bois combinés, dans l'une de nos finitions. **Usage intérieur** (traitement optionnel, après consultation, pour usage extérieur).

TREVI COLLECTION

Silla / chair / chaise P28

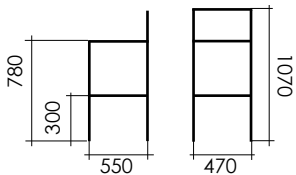

1.



2.



1. 1BB + 1MB + 1MB

2. 1BB + 3MB

* Respaldo y asiento de madera o acero y madera
Wood or steel & wood combined seat & back
Assise et dossier en bois ou acier et bois combinés.

MORRIS



1. MORRIS 1VI + 5MB / 2. MORRIS 1VI + 5MB (P25)

Estructura de acero pintado o barnizado, asiento de madera o acero, en cualquiera de nuestros acabados. **Uso interior** (tratamiento opcional, previa consulta, para uso exterior).

Painted or varnished steel structure, wood or steel seat, in any of our finishes. **Indoor use** (optional treatment, check before, for outdoor use).

Structure en acier peint ou verni, assise en bois ou acier. dans l'une de nos finitions. **Usage intérieur** (traitement optionnel, après consultation, pour usage extérieur).

MORRIS COLLECTION

Silla / chair / chaise P25

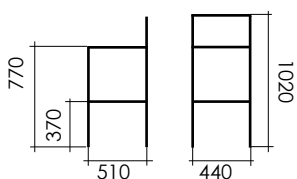

1. 1VI + 1MB
2. 1BB

*Asiento de madera o acero / Wood or steel seat /
Assise en bois ou acier.



VICO



VICO 1PL + 1MB

Estructura de acero pintado o barnizado, asiento de madera o tapizado, en cualquiera de nuestros acabados. **Uso interior** (tratamiento opcional, previa consulta, para uso exterior, excepto tapizado)

Painted or varnished steel structure, wood or upholstery seat, in any of our finishes. **Indoor use** (optional treatment, check before, for outdoor use, except upholstery).

Structure en acier peint ou verni, assise en bois ou rembourrage, dans l'une de nos finitions. **Usage intérieur** (traitement optionnel, après consultation, pour usage extérieur, sauf rembourré).

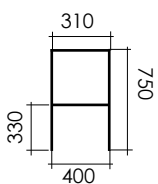

1. 5VI + 5MB
2. 1VI + Agnelli Blanco

* Asiento de madera o tapizado / Wood or pholstery seat / Assise en bois ou rembourrage.

LAGER



1. LAGER 1BBO + AGNELLI BLANCO / 2. LAGER 1BBO + PINO 11MB + AGNELLI BLANCO (P43) / 3. LAGER 1BBO (P98) + PINO RUSTIK 11MB (P117)

Alto y bajo, estructura de acero pintado o barnizado, asiento de madera de pino, cp marino o tapizado, en cualquiera de nuestros acabados. **Uso interior** (tratamiento opcional, previa consulta, para uso exterior, excepto tapizado)

High & mini, painted or varnished steel structure, upholstery, pinewood or marine plywood wood seat, in any of our finishes. **Indoor use** (optional treatment, check before, for outdoor use, except upholstery).

Haut et mini, structure en acier peint ou verni, assise en bois de pin, contreplaqué marine ou rembourrage, dans l'une de nos finitions. **Usage intérieur** (traitement optionnel, après consultation, pour usage extérieur, sauf rembourré).

LAGER COLLECTION

Carrito / Service cart / chariot de service P112

Silla / chair / chaise P33

Sofa P43

Mesa / table P98

Estanteria / Shelving / Etagère P111

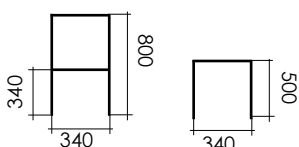

1. 1BB + 5MB / 2. 1BBO + 3MB IBERO / 3. 13PL + 9MB

* Alto y mini, asiento de madera de pino, mdf o tapizado / High & mini, pinewood, mdf or upholstery seat / Haut et mini, assise en bois de pin, mdf ou rembourrage.

FONTANA



FONTANA 4PL

Estructura de aluminio pintado o barnizado, en cualquiera de nuestros acabados. **Uso exterior.**

Painted or varnished aluminium structure, in any of our finishes. **Outdoor use.**

Structure en aluminium peint ou verni, dans l'une de nos finitions. **Usage extérieur.**

FONTANA COLLECTION

Silla / chair / chaise P52

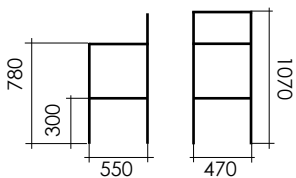

MINERVA



MINERVA 1PL - 3PL - 7PL

Estructura de aluminio pintado o barnizado, en cualquiera de nuestros acabados. **Uso exterior.**

Painted or varnished aluminium structure, in any of our finishes. **Outdoor use.**

Structure en aluminium peint ou verni, dans l'une de nos finitions. **Usage extérieur.**

MINERVA COLLECTION

Silla / chair / chaise P49

1.



2.

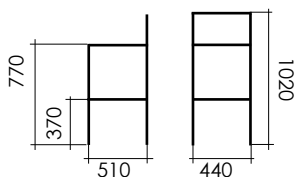

1. 1BB

2. 1VI

PALLET



PALLET 1PM + 5MB

Estructura de aluminio anodizado, tablillas en madera, en cualquiera de nuestros acabados. **Uso exterior.**

Anodized aluminium structure, wood slats, in any of our finishes. **Outdoor use.**

Structure en aluminium anodisé, lattes en bois, dans l'une de nos finitions. **Usage extérieur.**

PALLET COLLECTION

Silla / chair / chaise P67

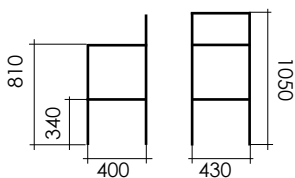

1.



2.



1. 1PM + 9MB

2. 1PM + 5MB

PORTO



PORTO 3PL

Estructura de aluminio pintado o anodizado, en cualquiera de nuestros acabados. **Uso exterior.**

Painted or anodized aluminium structure, in any of our finishes. **Outdoor use.**

Structure en aluminium peint ou anodisé, dans l'une de nos finitions. **Usage extérieur.**

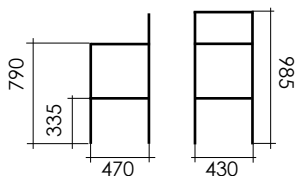

1.

2.



1. 1PB

2. 5PL

* Estructura anodizada o pintada / Anodized or painted structure / Structure anodisé ou peint.

KIOTO



KIOTO 1PL + 9MB

Estructura de aluminio pintado, tablillas en aluminio o madera, en cualquiera de nuestros acabados.

Uso exterior.

Painted aluminium structure, aluminium or wood slats, in any of our finishes. **Outdoor use.**

Structure en aluminium peint, lattes en aluminium ou bois, dans l'une de nos finitions. **Usage extérieur.**

KIOTO COLLECTION

Silla / chair / chaise P66

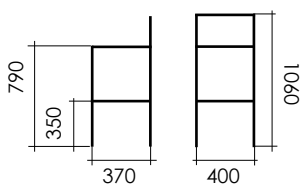

1. 9PL
2. 1PL + 5MB

* Tablillas de aluminio o madera / Aluminium or wood slats / Lattes en aluminium ou bois.

APOLO



APOLO 1PM + 9MB + 9MB

Patas de aluminio anodizado o madera, asiento de polipropileno o madera, en cualquiera de nuestros acabados. **Uso exterior** con patas de aluminio y asiento de polipropileno (tratamiento opcional, previa consulta, para uso exterior con patas y asiento de madera).

Anodized aluminium or wood legs, polypropylene or wood seat, in any of our finishes. With aluminium legs & polypropylene seat **outdoor use** (optional treatment, check before, for outdoor use with wood legs & seat).

Pattes en aluminium anodisé ou bois, assise en polypropylène ou bois, dans l'une de nos finitions. **Usage extérieur** avec pattes en aluminium et assise en polypropylène (traitement optionnel, après consultation, pour usage extérieur avec pattes et assise en bois)

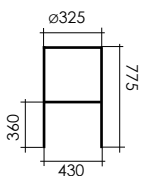

1. 1PB + 7PP
2. 1PM + 9MB + 9MB

* Patas de aluminio o madera y asiento de polipropileno o madera / Aluminium or wood legs & polypropylene or wood seat / Pattes en aluminium ou bois et assise en polypropylène ou bois.

YOKO



1.

2.

1. YOKO1PL + 1PP + 7PP / 2. BÁSICA 1PL (P95) + COMPACT F3091 CRYSTAL WHITE (P119)
 Alto y mini, estructura de acero pintado, asiento de polipropileno monocolor o bicolor, en cualquiera de nuestros acabados. **Uso interior** (tratamiento opcional, previa consulta, para uso exterior).

High & mini, painted steel structure. monocolor or bicolor polypropylene seat, in any of our finishes. **Indoor use** (optional treatment, check before, for outdoor use).

Haut et mini, structure en acier peint, assise de polypropylène en une ou deux couleurs, dans l'une de nos finitions. **Usage intérieur** (traitement optionnel, après consultation, pour usage extérieur).

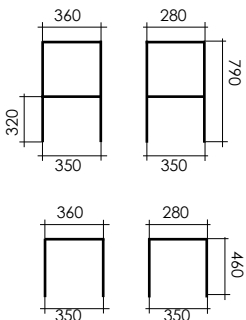

1.



2.



3.



* Alto y mini, asiento en polipropileno monocolor o bicolor / High & mini, one or two colors polypropylene seat / Haut et mini, assise de polypropylène en une ou deux couleurs.

1. 9PL + 7PP + 1PP / 2. 7PL + 1PP / 3. 3PL + 3PP + 1PP

YOKO APILABLE



YOKO APILABLE 2PL + 2PP / 4PL + 4PP / 10PL + 1PP + 7PP / 5PL + 8PP

Estructura de aluminio pintado, asiento de polipropileno monocolor o bicolor, en cualquiera de nuestros acabados. **Uso exterior.** Apilable.

Painted aluminium structure, monocolour or bicolor polypropylene seat, in any of our finishes. **Outdoor use.** Stackable.

Structure en aluminium peint, assise de polypropylène en une ou deux couleurs, dans l'une de nos finitions. **Usage extérieur.** Empilable.

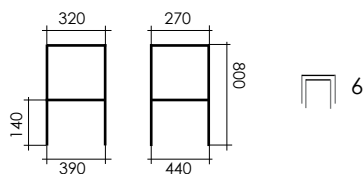

* Asiento en polipropileno monocolor o bicolor / One or two colors polypropylene seat / Assise de polypropylène en une ou deux couleurs.

1. 5PL + 5PP / 2. 10PL + 2PP

TIMÓN



TIMÓN 1PB + 7MB

Estructura de aluminio anodizado, asiento de madera, en cualquiera de nuestros acabados. **Uso interior.**

Anodized aluminium structure, wood seat, in any of our finishes. **Indoor use.**

Structure en aluminium anodisé, assise en bois, dans l'une de nos finitions. **Usage intérieur.**

1.



2.

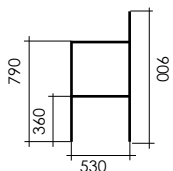

1. 1PM + 3MB

2. 1PM + 2MB

BITTER



BITTER 1PB + 3PP

Patatas de aluminio anodizado, asiento de aluminio anodizado o poliamida, en cualquiera de nuestros acabados. **Uso exterior.**

Anodized aluminium legs, anodized aluminium or polyamide seat, in any of our finishes. **Outdoor use.**

Pattes en aluminium anodisé, assise en aluminium anodisé ou polyamide, dans l'une de nos finitions. **Usage extérieur.**

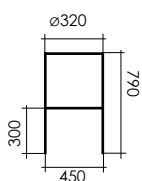

1. 1PB + 10PP

2. 1PB

* Asiento en poliamida o aluminio / Polyamide or aluminium seat / Assise de polyamide ou aluminium.

BENDER



1. BENDER1BB + MDF 9MB (P117) / 2. MORRIS 1BB + 3MB - 1BB + 4MB (P25)

Estructura de acero pintado, en cualquiera de nuestros acabados. **Uso interior** (tratamiento opcional, previa consulta, para uso exterior).

Painted steel structure, in any of our finishes. **Indoor use** (optional treatment, check before, for outdoor use).

Structure en acier peint, dans l'une de nos finitions. **Usage intérieur** (traitement optionnel, après consultation, pour usage extérieur).

Bender alta	Bender 4	Bender doble
TABLERO · TABLE TOP · PLATEAU		
Ø600 600x600	Ø600 600x600	1000x600 1100x700
Ø700 700x700	Ø700 700x700	1200x800
	Ø800 800x800	

BENDER COLLECTION

Silla / chair / chaise P23

Taburete / stool / tabouret 70



* Bender 4,
Bender doble,
Bender alta.

1. BENDER 4 1PL + COMPACT F3091 Crystal white (P119) / 2. BENDER DOBLE 1BBO + MDF IBERO 1MB (P117) / 3. BENDER ALTA 5PL + MDF IBERO 5MB (P117).

BIMBA



1. BIMBA 1VI + PINO 5MB (P117) / 2. MARGOT 1VI + Pieltech Premium 625 (P17) / 3. VELVET 1VI + 1MB + Pieltech Premium 625 (P18)

Estructura de acero pintado, en cualquiera de nuestros acabados. **Uso interior** (tratamiento opcional, previa consulta, para uso exterior).

Painted steel structure, in any of our finishes. **Indoor use** (optional treatment, check before, for outdoor use).

Structure en acier peint, dans l'une de nos finitions. **Usage intérieur** (traitement optionnel, après consultation, pour usage extérieur).

<p>1120 540 Bimba alta</p>	<p>740 540 Bimba</p>
TABLERO · TABLE TOP · PLATEAU	
Ø600 600x600 Ø700 700x700	Ø600 600x600 Ø700 700x700



1. BIMBA ALTA 4VI + MDF IBERO 2MB (P117)
 2. BIMBA 5VI + MDF 1MB (P117)
 * Bimba alta, Bimba.

POP



1. POP 5DT + COMPACT (P119) / 2. MINERVA 1PL (P49)

Base de acero inoxidable y tubo de aluminio acabado inox. **Uso exterior.**

Stainless steel base & aluminium inox finition tube. **Outdoor use.**

Base en acier inoxydable et tube en aluminium finition inox. **Usage extérieur.**

Pop 5dt alta	Pop 4 alta	Pop 3 alta	Pop 3	Pop 4	Pop 5	Pop 5dt
1000x600 1100x700 1200x800	Ø600 600x600 Ø700 700x700	Ø600 600x600	Ø600 600x600 Ø700 700x700 Ø800 800x800	Ø600 600x600 Ø700 700x700 Ø800 800x800	600x600 700x700 800x800 900x900 1000x600 1100x700	1000x600 1100x700 1200x800



1. POP 3 ALTA 1AI + MDF IBERO 9MB(P117)
2. POP 3 1AI + MDF IBERO 9MB (P117)
3. POP 4 1AI + COMPACT F2253 BLACK (P119)

BÁSICA



1. BÁSICA SUPER 3 1VI + MDF 2MB (P117) / 2. BENDER 1VI (P70) / 3. BENDER 1VI + 1MB (P70) / 4. BÁSICA 5DT 1VI + MDF 5MB (P117)

Estructura de acero pintado, en cualquiera de nuestros acabados. **Uso interior** (tratamiento opcional, previa consulta, para uso exterior).

Painted steel structure, in any of our finishes. **Indoor use** (optional treatment, check before, for outdoor use)

Structure en acier peint, dans l'une de nos finitions. **Usage intérieur** (traitement optionnel, après consultation, pour usage extérieur).

Básica 4 alta	Básica 3 alta	Básica 3 super	Básica 3	Básica 4	Básica 5	Básica 5dt
Ø600 600x600 Ø700 700x700	Ø600 600x600	Ø700 / 700x700 / Ø800 800x800 / Ø900 / 900x900 Ø1000 / 1000x1000 / Ø1100	Ø600 600x600 Ø700 700x700 Ø800	Ø600 600x600 Ø700 700x700 Ø800 800x800	600x600 700x700 800x800 900x900 1000x600 1100x700	1000x600 1100x700 1200x800



1. BASICA 4 ALTA 7PL + MDF IBERO 5MB (P117) / 2. BASICA 3 ALTA 5PL + MDF IBERO 1MB (P117) / 3. BASICA 3 13PL + PINO 5MB (P117) / 4. BASICA 4 3PL + MDF IBERO 3MB (P117)

TRÉBOL



1. TRÉBOL 4VI / 2. CAPRI VINTAGE 4VI + Fibra vintage (P60)

Estructura de acero pintado o barnizado, en cualquiera de nuestros acabados. **Uso interior** (tratamiento opcional, previa consulta, para uso exterior).

Painted or varnished steel structure, in any of our finishes. **Indoor use** (optional treatment, check before, for outdoor use).

Structure en acier peint ou verni, dans l'une de nos finitions. **Usage intérieur** (traitement optionnel, après consultation, pour usage extérieur).

<p>740 Ø640 Trébol 64</p>		<p>740 Ø740 Trébol 74</p>		<p>740 Ø840 Trébol 84</p>	
T A B L E R O		T A B L E T O P		P L A T E A U	
Ø700	700x700	Ø800	800x800	Ø900	900x900
Ø800	800x800	Ø900	900x900	Ø1000	1000x1000



1. TREBOL 84 4VI + MDF IBERO 1MB (P117) / 2. TREBOL 74 1VI + MDF IBERO 4MB (P117) / 3. TREBOL 64 13PL + PINO 5MB (P117)

MIU



1. MIU 1BB + MDF 5MB (P117) / 2. SPARTA 1BB + Agnelli Klein (P29) / 3. SPARTA 1BB + 5MB (P29)

Estructura de acero pintado o barnizado, en cualquiera de nuestros acabados. **Uso interior** (tratamiento opcional, previa consulta, para uso exterior).

Painted or varnished steel structure, in any of our finishes. **Indoor use** (optional treatment, check before, for outdoor use).

740 Ø540 Miu 54	740 Ø640 Miu 64	740 Ø740 Miu 74
TABLERO · TABLE TOP · PLATEAU		
Ø600 600x600	Ø700 700x700	Ø800 800x800 Ø900

Structure en acier peint ou verni, dans l'une de nos finitions. **Usage intérieur** (traitement optionnel, après consultation, pour usage extérieur).



MIU COLLECTION

Taburete / stool / tabouret P76

1. MIU 74 4VI + PINO 5MB (P117) / 2. MIU 64 7PL + MDF IBERO 9MB (P117) /

3. MIU 54 1VI + MDF IBERO 1MB (P117)

LAGER



1. LAGER ALTA 1BBO + PINO 9MB / 2. LAGER 1BBO + PINO 9MB (P117) / 3. LAGER 1BBO + PINO 9MB / 4. LAGER NUBE 320 + 1BBO + 9MB (P43) / 5. LAGER 1BBO + 9MB (P33) / 6. LAGER 1BBO + PINO 9MB / 7. LAGER 1BBO + PINO 9MB (P81) / 8. LAGER 1BBO + PINO 9MB (P111)

Estructura de acero pintado o barnizado, en cualquiera de nuestros acabados. **Uso interior** (tratamiento opcional, previa consulta, para uso exterior).

Painted or varnished steel structure, in any of our finishes. **Indoor use** (optional treatment, check before, for outdoor use).

Structure en acier peint ou verni, dans l'une de nos finitions. **Usage intérieur** (traitement optionnel, après consultation, pour usage extérieur).

1120		740		740	
Lager alta		Lager		Lager	
TABLERO · TABLE TOP · PLATEAU					
600x600	700x700	600x600	700x700	1000x600	1100x700
800x800	1000x600	800x800	900x900	1100x800	1200x700
1100x700		1000x1000		1200x800	1300x700
				1300x800	

LAGER COLLECTION

Silla / chair / chaise P33

Taburete / stool / tabouret P81

Sofa P43

Carrito / Service cart / chariot de service P112

Estanteria / Shelving / Etagère P111



1. LAGER ALTA 13PL + MDF IBERO 5MB (P117) / 2. LAGER 1BBO + PINO 9MB (P117) / 3. LAGER 1VI + PINO 11MB BURN (P117)

NINA



1. NINA 1MT + CALACATA (P118) / 2. NICOLE 1MT + 9MB + COJÍN "NIZA" VELVET PLUS 12 VERDE (P34)

Estructura de acero pintado o barnizado, en cualquiera de nuestros acabados. **Uso interior** (tratamiento opcional, previa consulta, para uso exterior).

Painted or varnished steel structure, in any of our finishes. **Indoor use** (optional treatment, check before, for outdoor use).

Structure en acier peint ou verni, dans l'une de nos finitions. **Usage intérieur** (traitement optionnel, après consultation, pour usage extérieur).

NINA COLLECTION

Silla Nicole / Nicole chair / chaise Nicole P34

Silla Ninette / Ninette chair / chaise Ninette P35

<p>450 Ø470 Nina</p>	
TABLERO · TABLE TOP · PLATEAU	
Ø400	400x400
Ø500	500x500
Ø600	600x600



1. NINA 1BB + MDF 5MB (P117) / 2. NINA 7PL + MDF 9MB (P117)

AVANGARD



1. AVANGARD 1PL + COMPACT F3091 CRYSTAL WHITE (P119) / 2. LICEO 1PL (P59)

Estructura de aluminio pintado o anodizado, en cualquiera de nuestros acabados. **Uso exterior.** Abatible y apilable.

Painted or anodized aluminium structure, in any of our finishes.

Outdoor use. Folding & stackable

Structure en aluminium peint ou anodisé, dans l'une de nos finitions. **Usage extérieur.** Rabattable et empilable.

Avangard alta	Avangard	Apilado
TABLERO · TABLE TOP · PLATEAU		
Ø600	Ø600	600x600
Ø700	Ø700	700x700
	Ø800	800x800
	Ø900	



1. AVANGARD ALTA 1PB + INOX ARO 1PB (P119) / 2. AVANGARD 1PB + INOX ARO 1PB (P119) / 3. AVANGARD 1PL + COMPACT F3091 CRYSTAL WHITE (P119)

VIENA



1. VIENA 3 1VI + CP MARINO 3MB (P117) / 2. SYTTEN 1VI + 3MB (P27)

Viena 4 alta	Viena 3	Viena 4	Viena 5	Viena doble
T A B L E R O · T A B L E T O P · P L A T E A U				
Ø600 Ø700	Ø600 600x600 Ø700	Ø600 600x600 Ø700 700x700 Ø800 800x800 Ø900	Ø600 600x600 Ø700 700x700 Ø800 800x800 Ø900 Ø1000	1000x600 1100x700 1200x700 1200x800

Estructura de aluminio pintado o anodizado, en cualquiera de nuestros acabados. **Uso exterior.**

Painted or anodized aluminium structure, in any of our finishes. **Outdoor use.**

Structure en aluminium peint ou anodisé, dans l'une de nos finitions. **Usage extérieur.**



1. VIENA 4 1VI + ABEDUL 9MB (P118) / 2. VIENA 3PL + COMPACT F3091 CRYSTAL WHITE (P119)

MAX



1. MAX 4 + COMPACT F2200 D.CHOCO (P119) / 2. LICEO (P)

Max 3	Max 4	Max 5	Max 6	Max doble
T A B L E R O · T A B L E T O P · P L A T E A U				
ø700 ø800 ø900	ø900 700x700 ø1000 800x800 ø1100 900x900 ø1200 1000x1000	ø1200 ø1300 ø1400 ø1500	ø1500 ø1600 ø1800	1100x700 1100x800 1200x700 1200x800 1300x700 1300x800

Estructura de aluminio pintado, en cualquiera de nuestros acabados. **Uso exterior.**

Painted aluminium structure, in any of our finishes. **Outdoor use.**

Structure en aluminium peint, dans l'une de nos finitions. **Usage extérieur.**



1. MAX 3 4PL + PINO 5MB (P117) / 2. MAX 4 1VI + MDF IBERO 5MB (P117) / 3. MAX 5 13PL + CP MARINO ABEDUL 9MB (P118)

EQUIX



1. EQUIX 8PL + PINO RUSTIK 5MB (P117) / 2. MARGOT 1BB + AGNELLI CUERO (P17)

Estructura de aluminio pintado, en cualquiera de nuestros acabados. **Uso exterior.**

Painted aluminium structure, in any of our finishes.

Outdoor use.

Structure en aluminium peint, dans l'une de nos finitions. **Usage extérieur.**

Equix 4 alta	Equix 4	Equix doble
TABLERO · TABLE TOP · PLATEAU		
Ø600 Ø700	Ø600 600x600 Ø700 700x700	1100x600 1200x700 1200x800



1. EQUIX 4 ALTA 5PL+MDF IBERO 1MB (P117) / 2. EQUIX DOBLE 7PL / 3. EQUIX 4+ABEDUL IBERO 5MB (P118)

CLICK



1. CLICK 5PL + ABEDUL 9MB (P118) / 2. TEBAS 5PL (P63) / 3. BIOMBO EQUIX 5PL (P115)

Estructura de aluminio pintado o barnizado, en cualquiera de nuestros acabados. **Uso exterior.** Abatible y apilable.

Painted or varnished aluminium structure, in any of our finishes. **Outdoor use.** Folding & stackable

Outdoor use. Folding & stackable

Structure en aluminium peint ou verni, dans l'une de nos finitions. **Usage extérieur.** Rabattable et empilable.

Click alta	Click	Apilado
TABLERO · TABLE TOP · PLATEAU		
ø600	ø500	600x600
ø700	ø600	700x700
	ø700	800x800
	ø800	



1.



2.



1. CLICK ALTA 4PL + ABEDUL IBERO 4MB (P117) / 2. CLICK 1BB + COMPACT IBERO (P120)

SEVILLA



1. SEVILLA 3 1PM + INOX ARO 1PM (P119) / 2. JAVA 1PB + 5TF (P57)

Estructura de aluminio anodizado, en cualquiera de nuestros acabados.

Uso exterior.

Anodized aluminium structure, in any of our finishes. **Outdoor use.**

Structure en aluminium anodisé, dans l'une de nos finitions. **Usage extérieur.**

Sevilla 4 alta	Sevilla 3	Sevilla 4	Sevilla doble
Ø500 Ø600 Ø700	Ø600 600x600 Ø700	Ø600 600x600 Ø800 700x700 Ø900 800x800	1000x600 1100x700 1200x700 1200x800



1. SEVILLA 4 ALTA 1PB + COMPACT F3091 CRYSTAL WHITE (P119) / 2. SEVILLA DOBLE 1PB + INOX REPULSADO 1PB (P119) / 3. SEVILLA 3 1PB + ESTRATIFICADO ARO 1PB - F3091 CRYSTAL WHITE (P118) / 4. SEVILLA 4 1PB + INOX REPULSADO 1PB (P119)

FEDRA



1. FEDRA 1PB + CP MARINO INOX ARO (P119) / 2. JAVA 1PB + 7TF (P57)

Estructura de aluminio anodizado, en cualquiera de nuestros acabados. **Uso exterior.**

Anodized aluminium structure, in any of our finishes. **Outdoor use.**

Structure en aluminium anodisé, dans l'une de nos finitions. **Usage extérieur.**



<p style="text-align: center;">Fedra</p>	
TABLERO · TABLE TOP · PLATEAU	
Ø600	600x600
Ø700	

1. FEDRA 1PB + CP MARINO INOX ARO 1PB (P119) /
2. FEDRA 1PB + COMPACT F2253 BLACK (P119)

VELA



1. VELA 4PL + Compact F3091 Crystal White (P119) / 2. ACHE 4PL (P62)

Estructura de aluminio pintado o anodizado, en cualquiera de nuestros acabados. **Uso exterior.**

Painted or anodized aluminium structure, in any of our finishes.

Outdoor use.

Structure en aluminium peint ou anodisé, dans l'une de nos finitions. **Usage extérieur.**

Vela alta	Vela 3	Vela 4	Vela doble
T A B L E R O · T A B L E T O P · P L A T E A U			
Ø500 Ø600 Ø700	Ø600 600x600 Ø700	Ø600 600x600 Ø800 700x700 Ø900 800x800	1000x600 1100x700 1200x700 1200x800



1. VELA 4 1PB + INOX REPULSADO 1PB (P119) / 2. VELA 3 1PB + INOX ARO 1PB (P119) / 3. VELA DOBLE 1PB + INOX ARO 1PB (P119) / 4. VELA 4 ALTA 1PB + INOX ARO 1PB (P119)

KATER



KATER 1PM + COMPACT F7912 STORM (P119)

Estructura de aluminio pintado o anodizado, en cualquiera de nuestros acabados. **Uso exterior.** Apilable.

Painted or anodized aluminium structure, in any of our finishes. **Outdoor use.** Stackable.

Structure en aluminium peint ou anodisé, dans l'une de nos finitions. **Usage extérieur.** Empilable.

Kater alta	Kater	Kater
TABLERO · TABLE TOP · PLATEAU		
600x600 800x800 1100x700	700x700 1000x600	600x600 800x800 1000x1000
		1000x600 1100x800 1200x800 1300x800
		1100x700 1200x700 1300x700

8



1. KATER 8PL + COMPACT F7927 FOLKESTONE (P119)

2. KATER 1PM

ALZA



1. ALZA 4DT 1PB + INOX ARO 1PB (P119) / 2. JAVA 1PB + 5TF-8TF (P57)

Estructura de aluminio pintado o anodizado, en cualquiera de nuestros acabados. **Uso exterior.** Apilable.

Painted or anodized aluminium structure, in any of our finishes. **Outdoor use.** Stackable.

Structure en aluminium peint ou anodisé, dans l'une de nos finitions. **Usage extérieur.** Empilable.

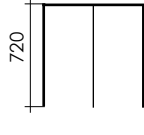
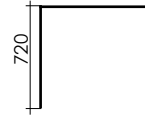
	
Alza 3	Alza 4 / Alza DT
TABLERO · TABLE TOP · PLATEAU	
Ø600	600x600 1000x600 1100x700
Ø700	700x700 1100x800 1200x700
Ø800	800x800

 8



1. ALZA 3 1PB + INOX ARO 1PB (P119) / 2. ALZA 3 5PL + COMPACT F2200 D.CHOCO (P119) / 3. ALZA 4DT 1PB + INOX ARO 1PB (P119) / 4. ALZA 4 1PB + INOX ARO 1PB (P119)

FLEXIT



1. FLEXIT 4 5PL + COMPACT F2200 D.CHOCO (P119) / 2. MORRIS 5PL + 5MB (P25)

Estructura de aluminio pintado o anodizado, en cualquiera de nuestros acabados. **Uso exterior.** Apilable.

Painted or anodized aluminium structure, in any of our finishes. **Outdoor use.** Stackable.

Structure en aluminium peint ou anodisé, dans l'une de nos finitions. **Usage extérieur.** Empilable.

TABLERO · TABLE TOP · PLATEAU			
Ø600	Ø700	600x600	Ø800
Ø800	Ø900	700x700	Ø900
		800x800	900x900



1. FLEXIT 4 5PL + COMPACT F2200 D.CHOCO (P119)
2. FLEXIT 4 8PL + COMPACT F3091 CRYSTAL WHITE (P119)

LAGER



1. LAGER 1BBO + PINO 9MB (P117) / 2. LAGER 1BBO + PINO 9MB (P81)

Estructura de acero pintado o barnizado, madera de pino o cp marino, en cualquiera de nuestros acabados. Medidas y formato personalizables. **Uso interior** (tratamiento opcional, previa consulta, para uso exterior).

Painted or varnished steel structure, pine wood or marine plywood, in any of our finishes. Customizable. **Indoor use** (optional treatment, check before, for outdoor use)

Structure en acier peint ou verni, bois de pin ou contreplaqué marine, dans l'une de nos finitions. Personnalisable. **Usage intérieur** (traitement optionnel, après consultation, pour usage extérieur).

LAGER COLLECTION

Carrito / Service cart / chariot de service P112

Silla / chair / chaise P33

Taburete / stool / tabouret P81

Sofa P43

Mesa / table P117

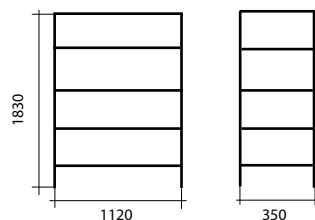

1. LAGER 1BBO + PINO IBERO 1MB
2. LAGER 1BBO + PINO 9MB

LAGER



1. LAGER 1VI + 11MB BICOLOR (P33) / 2. LAGER 1VI + PINO RUSTIK 11MB BICOLOR

Estructura de acero pintado o barnizado, madera de pino o cp marino, en cualquiera de nuestros acabados. Medidas y formato personalizables. **Uso interior** (tratamiento opcional, previa consulta, para uso exterior).

Painted or varnished steel structure, pine wood or marine plywood, in any of our finishes. Customizable. **Indoor use** (optional treatment, check before, for outdoor use)

Structure en acier peint ou verni, bois de pin ou contreplaqué marine, dans l'une de nos finitions. Personnalizable. **Usage intérieur** (traitement optionnel, après consultation, pour usage extérieur).

LAGER COLLECTION

Estanteria / Shelving / etagère P111

Silla / chair / chaise P33

Taburete / stool / tabouret P81

Sofa P43

Mesa / table P98

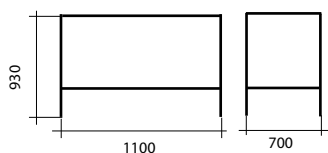

1. LAGER 1VI + PINO IBERO 2MB
2. LAGER 1VI + PINO RUSTIK 11MB

PARAVIENTO RÍGIDO



PARAVIENTO RÍGIDO 5PL + COMPACT F3091 CRYSTAL WHITE

Estructura de aluminio pintado o anodizado, base en acero pintado, compacto y metacrilato transparente, en cualquiera de nuestros acabados. Modular, medidas personalizables. **Uso exterior.**

Painted or anodized aluminium structure, painted steel base, transparent methacrylate, in any of our finishes. **Outdoor use.**

Structure en aluminium peint ou anodisé, base en acier peint, méthacrylate transparent, dans l'une de nos finitions. **Usage extérieur.**

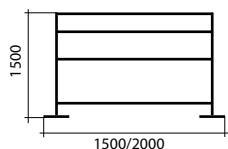

PARAVIENTO TÉXTIL



PARAVIENTO TÉXTIL 1PM + PVC BEIGE + EFECTO VENTANA

Estructura de aluminio anodizado mate, base en acero pintado, tejido en textileno o pvc, en cualquiera de nuestros acabados. Con o sin efecto ventana. Modulable, medidas personalizables. **Uso exterior.**

Matt nodized aluminium structure, painted steel base, textilenne or pvc fabric, in any of our finishes. With or without window effect. **Outdoor use.**

Structure en aluminium anodisé mat, base en acier peint, tissu en textilenne ou pvc, dans l'une de nos finitions. Avec ou sans effet de fenêtré. **Usage extérieur.**

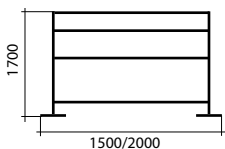

1PM + COUPAGE N1

BIOMBO



1. BIOMBO EQUIX 5PL / 2. TEBAS 5PL (P64) / 3. CLICK 5PL (P104) + ABEDUL 9MB (P118)

Biombo Vela o Equix, estructura de aluminio pintado o anodizado, tejido en textileno o pvc, en cualquiera de nuestros acabados. Medidas personalizables. Serigrafía opcional. **Uso exterior.**

Vela or Equix biombo, painted or anodized aluminium structure, textilene or pvc fabric, in any of our finishes. Customizable measures. Optional silk-screened. **Outdoor use.**

Biombo Vela ou Equix, structure en aluminium peint ou anodisé, tissu en textilene ou pvc, dans l'une de nos finitions. Mesures personnalisables. Sérigraphie optionnel. **Usage extérieur.**

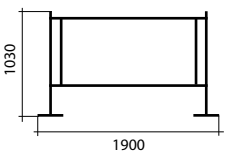

1. BIOMBO EQUIX 9PL + TEXTILENNE COUPAGE N1 / 2. BIOMBO VELA 1PB

MÓNACO



1. MÓNACO 1PL / 2. JAVA 1PB + 9TF (P57) / 3. AVANGARD 1PB (P100) + COMPACT (P119)

Estructura de aluminio pintado blanco o anodizado mate, tela acrílica 100% masacril 300g/m2, base pintada en negro, anclada al suelo. **Uso exterior.**

White painted or matt anodized aluminium structure, acrylic fabric 100% masacril 300g/m2, black painted steel base, anchored to the ground. **Outdoor use.**

Structure en aluminium peint blanc ou anodisé mat, tissu acrylique 100% masacril 300g/m2, base en acier peinture noir, ancré au sol. **Usage extérieur.**

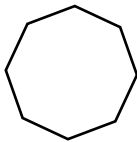
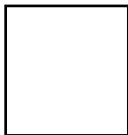
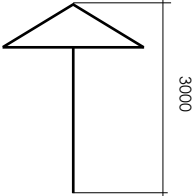

Mástil: 90x2 · Pole: 90x2 · Mât: 90x2

		
<p>∅3500 ∅4000 ∅5000</p>	<p>3000x3000 4000x4000</p>	<p>3000</p>

PINO



Pino macizo barnizado. En cualquiera de nuestros acabados. Grosor 42mm. Uso interior.

Varnished solid pine. In any of our finishes. 42mm thick. Indoor use.

Pin massif verni. Dans l'une de nos finitions. Groseur 42mm. Usage intérieur.

PINO RUSTIK



Pino macizo barnizado. Acabado manual de hendiduras. En cualquiera de nuestros acabados. Grosor 40mm. Uso interior.

Varnished solid pine. In any of our finishes. Manual slit finishing. 40mm thick. Indoor use.

Pin massif verni. Fentes de finition manuelle. Dans l'une de nos finitions. Groseur 40mm. Usage intérieur.

MDF



Fibra natural barnizado. En cualquiera de nuestros acabados. Grosor 22mm. Uso interior.

Natural fiber board and edge. Varnished. In any of our finishes. 22mm thick. Indoor use.

Fibre natural. Verni. Dans l'une de nos finitions. Groseur 22mm. Usage intérieur.

MDF IBERO



Fibra natural barnizado. En cualquiera de nuestros acabados. Grosor 22mm. Uso interior.

Natural fiber board and edge. Varnished. In any of our finishes. 22mm thick. Indoor use.

Fibre natural. Verni. Dans l'une de nos finitions. Groseur 22mm. Usage intérieur.

HARRY VINTAGE



Agglomerado chapado con melamina vintage. Grosor 30mm. Uso interior.

Agglomerate with vintage melamine veneer. 30mm thick. Indoor use.

Aggloméré avec plaqué de mélamine vintage. Groseur 30mm. Usage intérieur.

CP MARINO ABEDUL



Chapas de abedul contraplacadas. Barnizado. En cualquiera de nuestros acabados. Grosor 18mm. Uso interior / exterior

Plywood birch veneers. Varnished. In any of our finishes. 18mm thick. Indoor / outdoor use.

Birch placages contreplaqué. Verni. Dans l'une de nos finitions. Groseur 18mm. Usage intérieur / extérieur

CP MARINO ABEDUL IBERO



Chapas de abedul contraplacadas. Barnizado. En cualquiera de nuestros acabados. Grosor 18mm. Uso interior / exterior

Plywood birch veneers. Varnished. In any of our finishes. 18mm thick. Indoor / outdoor use. Birch placages contreplaqué. Verni. Dans l'une de nos finitions. Groseur 18mm. Usage intérieur / extérieur

CALACATTA



Contraplacado marino con chapa de estratificado en acabado calacatta y aro de aluminio anodizado en imitación latón. Grosor 25mm. Uso exterior.

Marine plywood with laminated veneer in calacatta finish and brass imitation anodized aluminium edge. 25mm thick. Outdoor use.

Contreplaqué marine avec une feuille de stratifié en finition calacatta et cercle d'aluminium anodisé imitation laiton. Groseur 25mm. Usage extérieur.

CP MARINO ESTRATIFICADO



Contraplacado marino con chapa de estratificado en cualquiera de nuestros acabados y aro de aluminio anodizado brillo o mate. Grosor 25mm. Uso exterior.

Marine plywood with laminated veneer in any of our finishes and matt or gloss anodized aluminium edge. 25mm thick. Outdoor use.

Contreplaqué marine avec une feuille de stratifié dans l'une de nos finitions et cercle d'aluminium anodisé mat ou naturel. Groseur 25mm. Usage extérieur.

CP MARINO INOX



Contraplacado marino con chapa de acero inoxidable. Aro de aluminio anodizado brillo o mate. Grosor 25mm. Uso exterior.

Marine plywood with stainless steel sheet . Matt or gloss aluminium edge. 25mm thick. Outdoor use.

Contreplaqué marine avec plaque en acier inoxydable. Cercle d'aluminium anodisé mat ou naturel. Groseur 25mm. Usage extérieur.

CP MARINO INOX REPULSADO

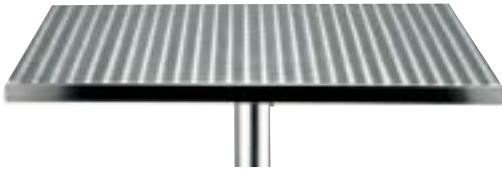

Contraplacado marino con chapa de acero inoxidable repulsada, anodizado en brillo o mate. Grosor 27mm. Uso exterior.

Marine plywood with bevelled stainless steel sheet. Matt or gloss anodized. 27mm thick. Outdoor use.

Contreplaqué marine avec plaque en acier inoxydable repoussé, anodisé mat ou naturel. Groseur 27mm. Usage extérieur.

COMPACT



Láminas de papel kraft pegadas con resina fenólica y estratificado de alta presión. Muy resistente a la intempérie. Grosor 10mm. En cualquiera de nuestros acabados. Uso interior / exterior.

Kraft-paper sheets glued with phenolic resin and high pressure laminate. Very resistant to inclemency of the weather. 10mm thick. In any of our finishes. Indoor / outdoor use.

Planches en papier kraft collé avec résine phénolique et stratifié d'haute pression. Très résistant aux intempéries. Groseur 10mm. Dans l'une de nos finitions. Usage intérieur / extérieur.

COMPACT IBERO



Láminas de papel kraft pegadas con resina fenólica y estratificado de alta presión. Muy resistente a la intemperie. Grosor 10mm. En cualquiera de nuestros acabados. Uso interior / exterior.

Kraft-paper sheets glued with phenolic resin and high pressure laminate. Very resistant to inclemency of the weather. 10mm thick. In any of our finishes. Indoor / outdoor use.

Planches en papier kraft collé avec résine phénolique et stratifié d'haute pression. Très résistant aux intempéries. Groseur 10mm. Dans l'une de nos finitions. Usage intérieur / extérieur.

TABLEROS / TABLE TOP / PLATEAU

Los tableros estratificados y compact de colores oscuros pueden sufrir variaciones de color con una exposición prolongada al sol.

Los tableros de DM hidrófugo con aro de aluminio están fabricados para uso exterior. Dependiendo de su uso y exposición excesiva al agua pueden sufrir variaciones de espesor.

The compact&laminate top tables with dark color may vary the tone with prolonged exposure to the sun.

DM table top (MDF) waterproof with aluminium edge are manufactured for outdoor use. However, depending of the use and excessive exposure to water may suffer variation in thickness.

Les compacts et stratifiés de couleur sombre peuvent subir des variations de ton suite à une exposition prolongée au soleil.

Les plateaux en DM hydrofuge avec cerclage en aluminium sont adaptés à un usage extérieur. Toutefois, en fonction de leur utilisation et d'une exposition excessive l'eau, ils peuvent subir des variations d'épaisseur.



HEE



Hostel Equip

Hostel Equip

*Paseo Marítimo Rey de España, 3. Local 3.
29640 Fuengirola – Málaga.*

*Dpto. Comercial - Tlf.:606.104.145 / 952.472.932
comercial1@hostelequip.es
coluntex@hostelequip.es*